

Fieldbus Electronics

G3 | Communication Node and I/O

580 | Communication Node

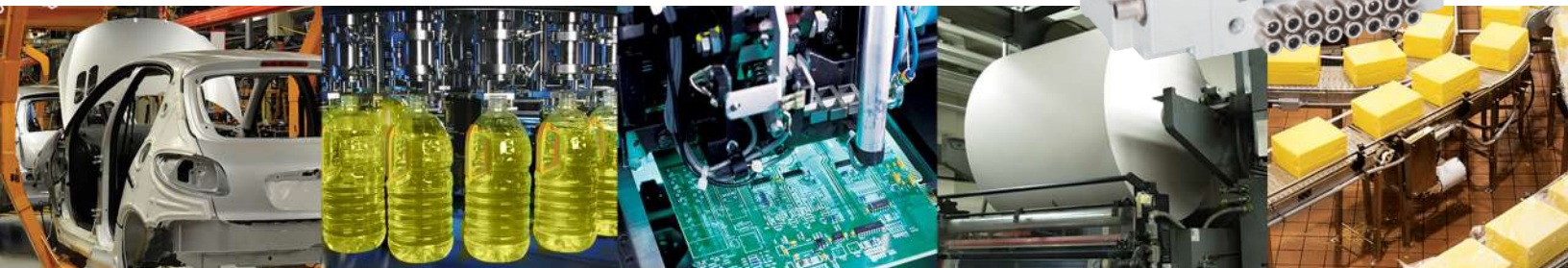
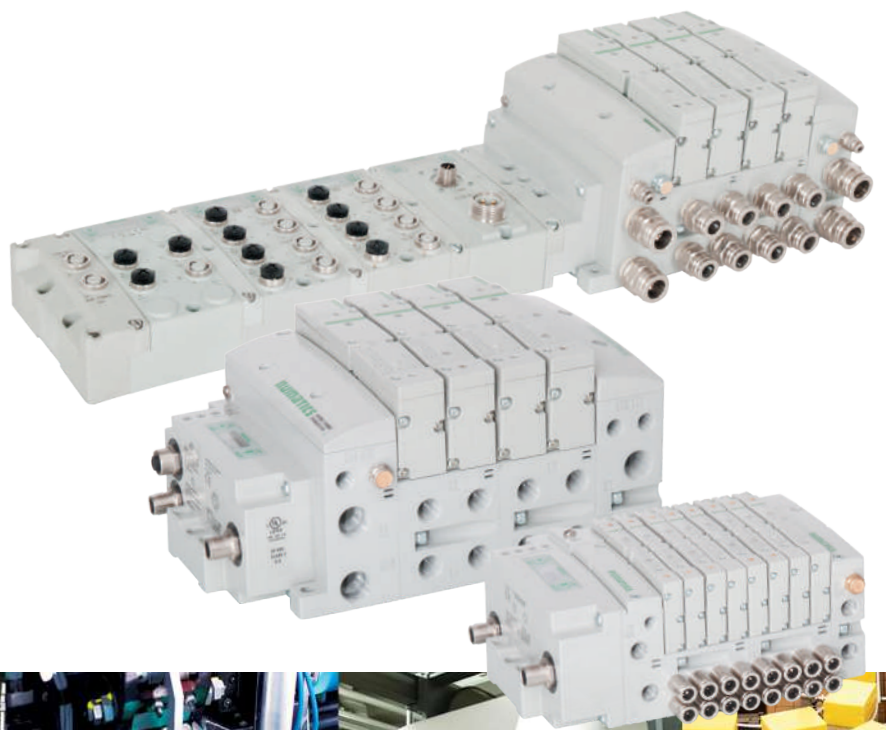

Table of Contents

G3 Electronics

Features and Benefits	2
G3 Platform Distribution Options	4
CANopen®	6
CC-Link IE Field™	7
DeviceNet™	8
EtherCAT®	9
EtherNet/IP™	10
EtherNet/IP™ DLR	11
Ethernet POWERLINK®	12
Modbus® TCP/IP	13
PROFIBUS™ DP	14
PROFINET™	15
I/O Modules	16
Input Modules - RTD & NAMUR IS	18
Sub-bus Modules	19
Miscellaneous Modules & Accessories	21
G3 Dimensions	23
G3 How To Order	25
501 Series	29
502 Series	32
503 Series	35
2002 R2 & 02 Series	38
2005 Series	40
2012 Series	42
2035 Series	44
ISO 15407-2 18mm Series	46
ISO 15407-2 26mm Series	48
ISO 5599/2 Series	50
Power Cables & Connectors	52
CANopen® and DeviceNet™ Cables & Connectors	55
CC-Link IE Field™ Cables & Connectors	56
EtherCAT® Cables & Connectors	57
EtherNet/IP™, EtherNet/IP™ DLR and Modbus® TCP/IP Cables & Connectors	58
Ethernet POWERLINK® Cables & Connectors	59
PROFIBUS™ DP Cables & Connectors	60
PROFINET™ Cables & Connectors	61
I/O Cables & Connectors	62
M23 19 Pin Cables & Connectors	65
Sub-bus Cables & Connectors	66

580 Series

Features and Benefits	68
CANopen®	69
DeviceNet™	70
EtherCAT®	71
EtherNet/IP™	72
EtherNet/IP™ DLR	73
Ethernet POWERLINK®	74
IO-Link®	75
PROFIBUS™ DP	76
PROFINET™	77
580 CHARM Node	78
580 Dimensions	79
580 How to Order	80
Power and Communication Cables & Connectors	82

G3 Fieldbus - Electronics Made Easy!

Innovative Graphic Display is used for easy commissioning, visual status & diagnostics.

Commissioning Capabilities

- Set network address (including IP & Subnet mask for Ethernet)
- Set baud rate
- Set auto or manual I/O sizes
- Set fault/idle output states
- Set brightness
- Set factory defaults
- Visual diagnostics
- Shorted and open load detection
- Shorted sensor/cable detection
- Low & missing power detection
- Missing module detection
- Self-test activation
- Log of network errors
- Distribution errors

G3 Fieldbus Communications Electronics

Why use Numatics Fieldbus communication electronics?
Modular Reality...

No internal wiring simplifies assembly

- SPEEDCON® M12 connector technology allows for fast and efficient ½ turn I/O connector attachment
- Power connector allows output power to be removed while inputs and communication are left active
- IP65 protection
- Up to 1,200 Input/1,200 Output capability with one communication node!
- Up to 128 valve solenoids per manifold, up to 17 manifolds per communication node!
- One node supports 16 I/O modules – Analog I/O, Digital I/O (NPN & PNP) and Specialty
- Integrated web server with EtherCAT®, EtherNet/IP™, EtherNet/IP™ DLR, Ethernet POWERLINK®, Modbus® TCP/IP, and PROFINET™
- Innovative clip design allows easy module removal/replacement without dismantling manifold
- Auto Recovery Module (ARM) protects configuration information during a critical failure. Allows configuration information to be saved and reloaded to replacement module automatically

*Numatics I/O with SPEEDCON® Technology

- 1/2 turn for faster I/O connections
- Backwards compatible with standard M12 cables/connectors
- Meets the same IP/NEMA standards as M12/Micro cables/connectors
- Same cost as standard M12/Micro cables/connectors
- See page 107 for cables with SPEEDCON® connector technology



Graphic Display for Configuration & Diagnostics



Auto Recovery Module



Highly Distributable



Easy, Robust Connections

Supported Protocols

- CANopen®
- CC-Link IE Field™
- DeviceNet™
- DeviceNet™ w/ QuickConnect™
- EtherCAT®
- EtherNet/IP™
- EtherNet/IP™ DLR w/ QuickConnect™
- Ethernet POWERLINK®
- Modbus® TCP/IP
- PROFIBUS™ DP
- PROFINET™

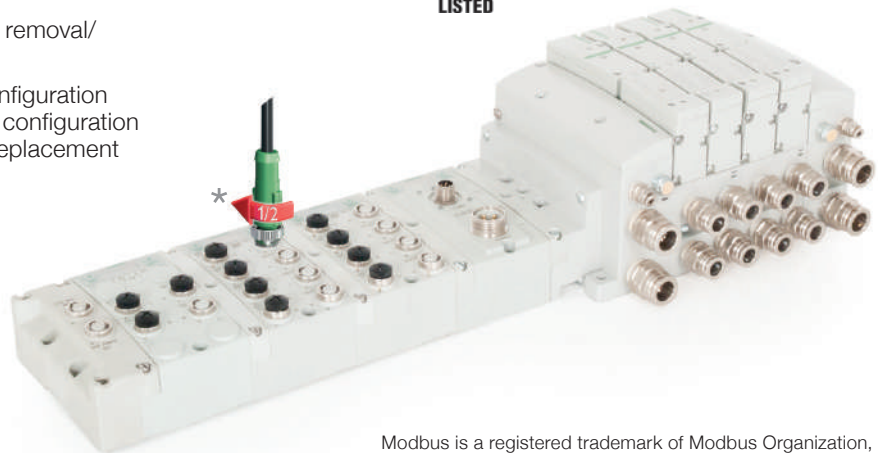

Modbus is a registered trademark of Modbus Organization, Inc.
EtherNet/IP, DeviceNet and QuickConnect are trademarks of ODVA.
EtherCAT is a registered trademark of the EtherCAT Technology Group.
CANopen is a registered Community trademark of CAN in Automation e.V.
PROFIBUS and PROFINET are trademarks of Profibus Nutzerorganisation e.V.
Ethernet POWERLINK is a registered trademark of Bernecker + Rainer Industrie – Elektronik Ges.m.b.H.
CC-Link is a registered trademark and CC-Link IE Field is a trademark of the CC-Link Partner Association.

G3 Electronics Modularity

Discrete I/O

The G3 Series product line is a completely modular system. All of the G3 electronic modules plug together, via mechanical clips, allowing easy assembly and field changes. This makes the system highly distributable. Additional flexibility is incorporated because the same modules can be used in either centralized or distributed applications.

The G3 electronics interfaces with the highly modular Numatics 500 Series, Generation 2000 Series, ISO 5599/2 and ISO 15407-2 Series valve lines to further enhance the modularity and flexibility of the entire system. 500 Series valves allow up to 128 valve solenoids per manifold when properly configured. An external air pilot supply may be required with more than 32 valve solenoids on a manifold.

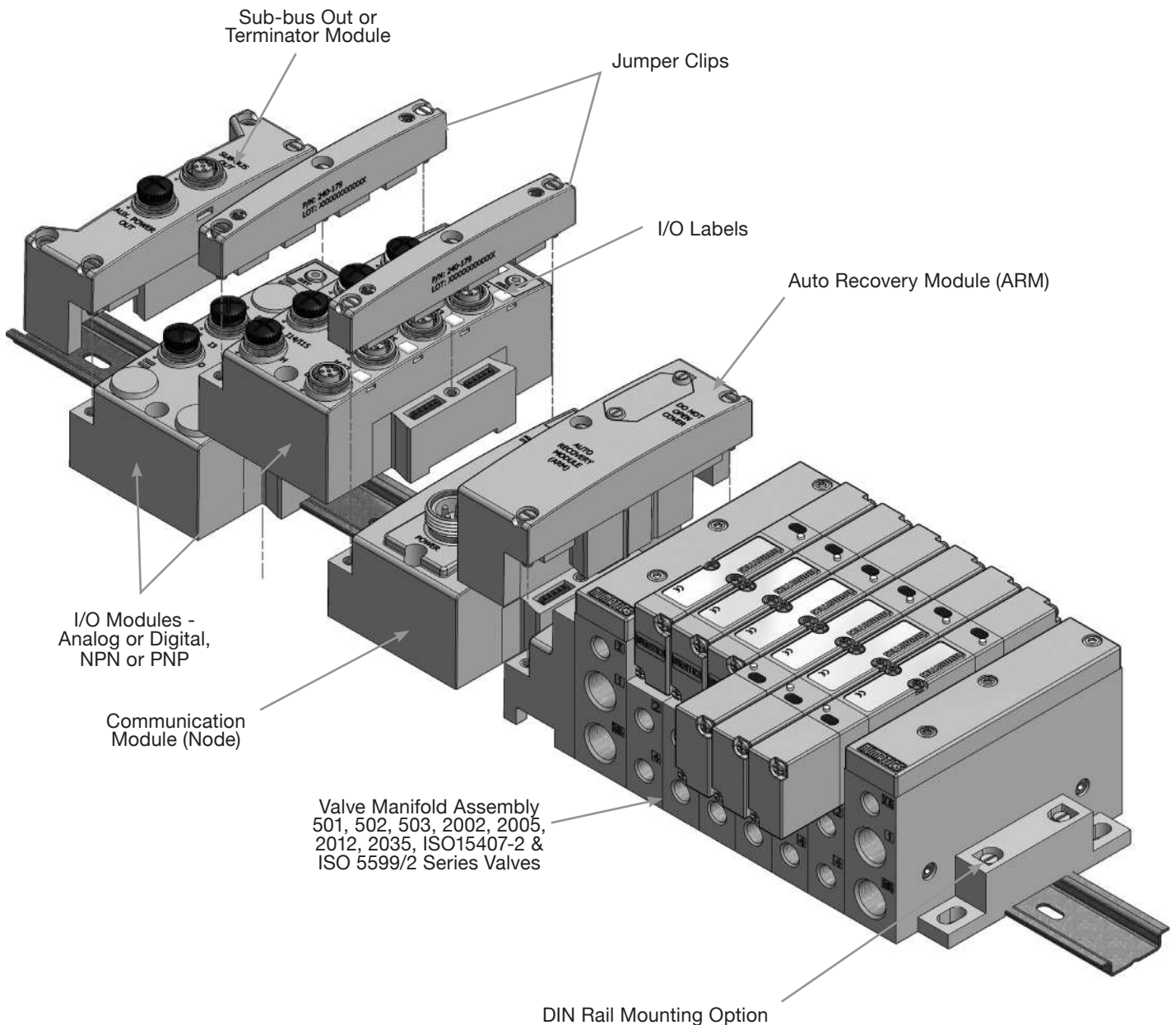

G3 Platform Distribution Options

Easy, Cost Effective Solutions for Digital I/O and Valve Automation using G3 Electronics.

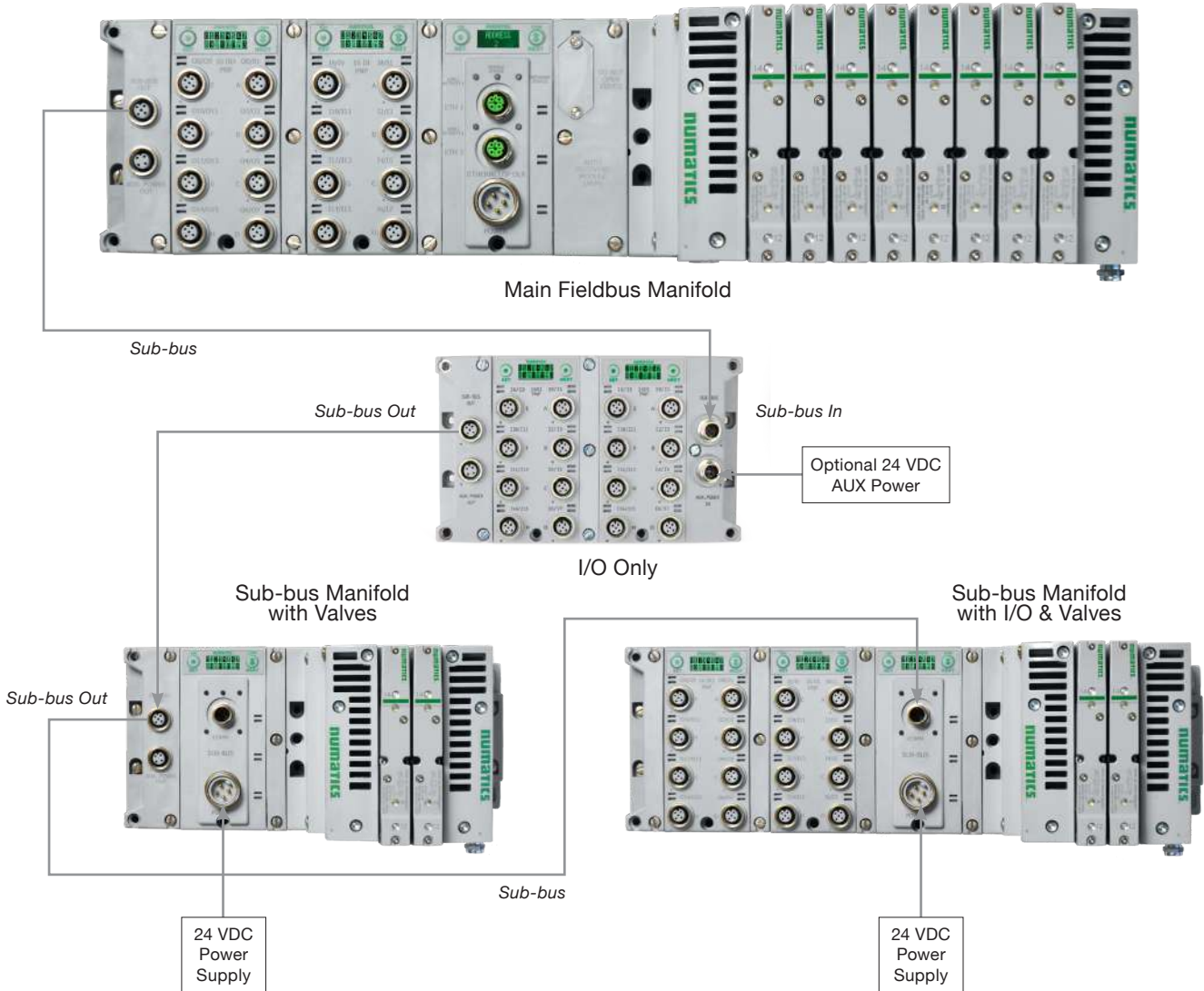

- Unique distribution system allows system efficiency by allowing the same modules to be used in either centralized or distributed applications
- Distribution options include:
 - Inputs OR Outputs
 - Inputs AND Outputs
 - Valves with Inputs AND Outputs
 - Valves with Inputs OR Outputs
 - Valves Only
- Maximum Sub-bus length not to exceed 30 meters. Maximum Sub-bus cable current not to exceed 4 amps or excessive cable voltage drops per segment. Auxiliary power connections available for currents above 4 amps. Consult factory for possible deviations

G3 Platform Distribution Options

The G3 platform is flexible to the point that there are a virtually infinite number of I/O distribution options using the few basic G3 modules. The following basic rules should be followed in the configuration of your control architecture.

Valve Side

- Up to a total of 128 valve solenoids can be driven in a manifold assembly integrated into the main fieldbus manifold. This can be any number of single or double solenoid valves with a total number of solenoids not to exceed 128

Typical Main Fieldbus Manifold

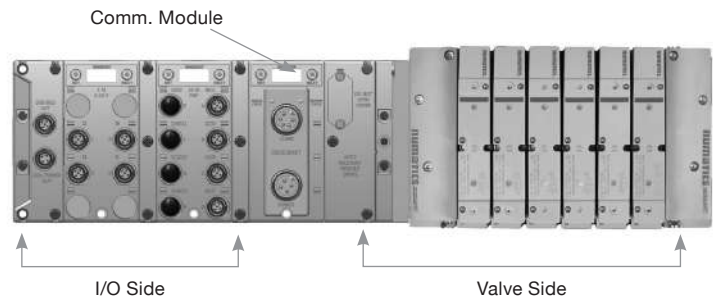

I/O Side Distribution

- A total of 16 modules can be integrated into the network and controlled by the main fieldbus communication module (node)
- Modules include analog and digital I/O modules providing addressing capacity for up to 1200 Inputs/1200 Outputs per node
- Unique distribution system allows system efficiency by allowing the same modules to be used in either centralized or distributed applications
- Distribution options include Inputs only, Outputs only, I/O only, valves with Inputs, valves with Outputs and valves with I/O
- Configuration can include up to 16 of the following modules:
 - Digital I/O modules
 - Sub-bus valve modules
 - Analog I/O modules

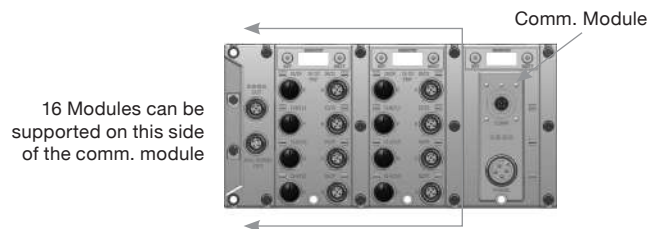
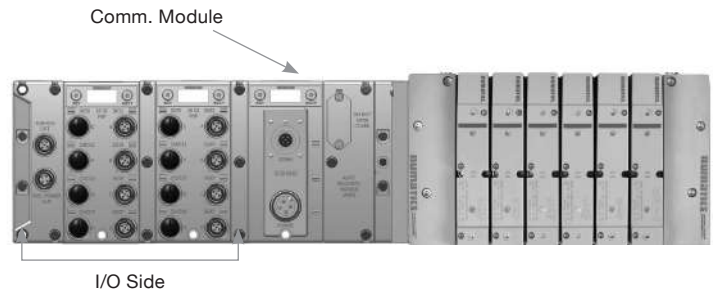

CANopen®

CANopen® is an open protocol based on Controller Area Network (CAN). It was designed for motion-oriented machine control networks but has migrated to various industrial applications. CAN in Automation (CIA) is the international users' and manufacturers' organization that develops and supports CAN-based protocols. Numatics' G3 nodes for CANopen® have an integrated graphic display and are capable of addressing combinations of up to 1200 outputs and 1200 inputs.

More information regarding this organization can be found at: www.can-cia.org.

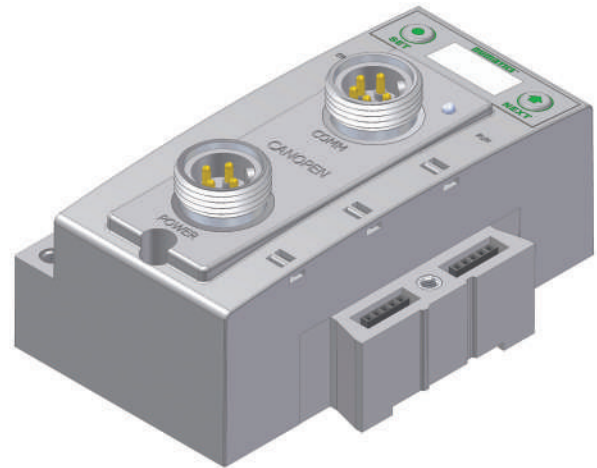

Description	Replacement Part Number
CANopen® Communications Module (node)	240-291

Technical Data

Electrical Data	Voltage	Current
Node Power at Max. Brightness	24 VDC +/- 10%	0.0404 Amps
Bus Power	11 – 25 VDC	0.025 Amps
Valves & Discrete I/O	24 VDC +/- 10%	8 Amps Maximum
Power Connector	Single key 4 Pin 7/8" MINI type (male)	
Communication Connector	Single key 5 Pin 7/8" MINI type (male)	
LEDs	Module Status and Network Status	

Operating Data	
Temperature Range (ambient)	-23 °C to 46 °C (-10 °F to 115 °F)
Humidity	95% relative humidity, non-condensing
Vibration/Shock	IEC 60068-2-27, IEC60068-2-6
Moisture Protection	IP65 (with appropriate assembly and termination)

Configuration Data	
Graphic Display	Display used for setting Node Address, Baud Rate, Fault/Idle Actions, and all other system settings
ARM	(Auto Recovery Module) Optional module that contains automatic recovery of system setting in the event of total or partial system failure
Maximum Valve-Solenoid Outputs	32
Maximum Addressable I/O Points	Various combinations of 1200 outputs and 1200 inputs

Network Data	
Supported Baud Rates	125K Baud, 250K Baud, 500K Baud, 1M Baud
Bus Connector	Single key 5 Pin 7/8" MINI type (male)
Diagnostics	Power, short, open load conditions and module health are monitored and fail-safe device settings

Weight	
CANopen® Communications Module	252g/8.9 oz

CC-Link IE Field™

CC-Link IE Field™ is an open standard 1 Gbps Ethernet Manufacturing network that enables seamless data communication from the plant-level enterprise network to the production floor network. The CC-Link Partner Association (CLPA) oversees and manages CC-Link® specifications.

Numatics' G3 nodes for CC-Link IE Field™ have an integrated graphic display and are capable of addressing combinations of up to 1200 outputs and 1200 inputs.

CC-Link IE Field™ is based on 1 Gbps Ethernet standards and complements them with specific protocols and mechanisms to achieve real time performance.

More information regarding CC-Link IE Field™ can be obtained from the following website: www.CCLinkAmerica.org



Description	Replacement Part Number
CC-Link IE Field™ Communications Module (node)	240-362

Technical Data

Electrical Data	Voltage	Current
Node Power at Max. Brightness	24 VDC +/- 10%	0.0495 Amps
Valves & Discrete I/O	24 VDC +/- 10%	8 Amps Maximum
Power Connector	Single key 5 Pin 7/8" MINI type (male)	
Communication Connector	Two X-coded 8 Pin M12 type (female)	
LEDs	Run, ERR, Link, D Link, L.ERR, L.ER	

Operating Data	
Temperature Range (ambient)	-23 °C to 46 °C (-10 °F to 115 °F)
Humidity	95% relative humidity, non-condensing
Vibration/Shock	IEC 60068-2-27, IEC60068-2-6
Moisture Protection	IP65 (with appropriate assembly and termination)

Configuration Data	
Graphic Display	Display used for setting Node Number, Network Number, Fault/Idle Actions, and all other system settings
ARM	(Auto Recovery Module) Optional module that contains automatic recovery of system setting in the event of total or partial system failure
Maximum Valve-Solenoid Outputs	128 for 501, 80 for 502/503 and 32 for all other series
Maximum Addressable I/O Points	Various combinations of 1200 outputs and 1200 inputs

Network Data	
Supported Baud Rates	1 Gbps
Bus Connector	Two D-coded 8 Pin M12 type (2-Female)
Diagnostics	Power, short, open load conditions and module health and configuration are monitored
Special Features	Integrated 2 port switch, fail-safe device settings

Weight	
CC-Link IE Field™ Communications Module	269g/9.5 oz

DeviceNet™

DeviceNet™ is an open bus fieldbus communication system developed by Allen-Bradley based on Controller Area Network (CAN) technology. The governing body for DeviceNet™ is the Open DeviceNet™ Vendors Association (ODVA). The ODVA controls the DeviceNet™ specification and oversees product conformance testing.

Numatics' G3 nodes for DeviceNet™ have an integrated graphic display and are capable of addressing combinations of up to 1200 outputs and 1200 inputs.

They have been tested and approved for conformance by the ODVA.

More information about DeviceNet™ and the ODVA can be obtained from the following website: www.odva.org.



Description	Replacement Part Number
DeviceNet™ Communications Module (node)	240-180

Technical Data

Electrical Data	Voltage	Current
Node Power at Max. Brightness	24 VDC +/- 10%	0.0404 Amps
Bus Power	11 – 25 VDC	0.025 Amps
Valves & Discrete I/O	24 VDC +/- 10%	8 Amps Maximum
Power Connector	Single key 4 Pin 7/8" MINI type (male)	
Communication Connector	Single key 5 Pin 7/8" MINI type (male)	
LEDs	Module Status and Network Status	

Operating Data	
Temperature Range (ambient)	-23 °C to 46 °C (-10 °F to 115 °F)
Humidity	95% relative humidity, non-condensing
Vibration/Shock	IEC 60068-2-27, IEC60068-2-6
Moisture Protection	IP65 (with appropriate assembly and termination)

Configuration Data	
Graphic Display	Display used for setting Node Address, Baud Rate, Fault/Idle Actions, DeviceNet™ w/ QuickConnect™ and all other system settings
ARM	(Auto Recovery Module) Optional module that contains automatic recovery of system setting in the event of total or partial system failure
Maximum Valve-Solenoid Outputs	32
Maximum Addressable I/O Points	Various combinations of 1200 outputs and 1200 inputs

Network Data	
Supported Baud Rates	125K Baud, 250K Baud, 500K Baud, with Auto-Baud detection
Supported Connection Type	Polled, Cyclic, Change of State (COS) and combination Message Capability
Bus Connector	Single key 5 Pin 7/8" MINI type (male)
Diagnostics	Power, short, open load conditions and module health are monitored
Special Features	Supports Auto-Device Replacement (ADR) and fail-safe device settings, and QuickConnect™ capability

Weight	
DeviceNet™ Communications Module	252g/8.9 oz

EtherCAT®

EtherCAT® is an open ethernet-based fieldbus protocol developed by Beckhoff. EtherCAT® sets new standards for real-time performance and topology flexibility with short data update/cycle times and low communication jitter.

Numatics' G3 EtherCAT® node has an integrated graphic display for simplified commissioning and diagnostics. It is capable of addressing combinations of up to 1200 outputs and 1200 inputs.

The G3 nodes for EtherCAT® have been designed and tested to conform with EtherCAT® specifications set forth by the ETG.

More information regarding EtherCAT® can be obtained from the following website: www.ethercat.org.



Description	Replacement Part Number
EtherCAT® Communications Module (node)	240-310

Technical Data

Electrical Data	Voltage	Current
Node Power at Max. Brightness	24 VDC +/- 10%	0.073 Amps
Valves and Discrete I/O	24 VDC +/- 10%	8 Amps Maximum
Power Connector	Single key 5 Pin 7/8" MINI type (male)	
Communication Connector	Two D-coded 4 Pin M12 type (female)	
LEDs	Module Status, Network Status and Activity /Link	

Operating Data	
Temperature Range	-23 °C to 46 °C (-10 °F to 115 °F)
Humidity	95% relative humidity, non-condensing
Vibration/Shock	IEC 60068-2-27, IEC 60068-2-6
Moisture	IP65 (with appropriate assembly and termination)

Configuration Data	
Graphic Display	Display used for setting IP address, Subnet Mask, Fault/Idle Actions, and all other system settings
ARM	(Auto Recovery Module) Optional module that contains automatic recovery of system settings in the event of total or partial system failure
Maximum Valve Solenoid Outputs	128 for 501, 80 for 502/503 and 32 for all other series
Maximum Sub-bus I/O Points	Various combinations of 1200 outputs and 1200 inputs

Network Data	
Supported Baud Rates	10 Mbit/100 Mbit
Bus Connector	Two D-coded 4 Pin M12 type (female)
Diagnostics	Power, short, open load conditions and module health and configuration are monitored
Special Features	Integrated web server, fail-safe device settings

Weight	
EtherCAT® Communications Module	227g /8 oz

EtherNet/IP™

Ethernet used throughout the world to network millions of PCs has now evolved into a viable industrial network. Ethernet is an open architecture high-level communication network that meets the demands of today's industrial applications requiring high-speed (10/100 Mbit/s), high-throughput and flexibility. Additionally, Ethernet technology can integrate an on-board web server, which can make the node readily accessible to any standard web browser for configuration, testing and even retrieval of technical documentation.

Numatics' G3 nodes for EtherNet/IP™ have an integrated graphic display and are capable of addressing combinations of up to 1200 outputs and 1200 inputs.

The G3 EtherNet/IP™ nodes have been tested and approved for conformance by the ODVA.

More information about EtherNet/IP™ and the ODVA can be obtained from the following website: www.odva.org.



Description	Replacement Part Number
EtherNet/IP™ Communications Module (node)	240-181

Technical Data

Electrical Data	Voltage	Current
Node Power at Max. Brightness	24 VDC +/- 10%	0.0657 Amps
Valves & Discrete I/O	24 VDC +/- 10%	8 Amps Maximum
Power Connector	Single key 4 Pin 7/8" MINI type (male)	
Communication Connector	D-coded 4 Pin M12 type (female)	
LEDs	Module Status, Network Status and Activity/Link	

Operating Data	
Temperature Range (ambient)	-23 °C to 46 °C (-10 °F to 115 °F)
Humidity	95% relative humidity, non-condensing
Vibration/Shock	IEC 60068-2-27, IEC60068-2-6
Moisture Protection	IP65 (with appropriate assembly and termination)

Configuration Data	
Graphic Display	Display used for setting IP Address, Subnet mask, Fault/Idle Actions, DHCP/BootP and all other system settings
ARM	(Auto Recovery Module) Optional module that contains automatic recovery of system setting in the event of total or partial system failure
Maximum Valve-Solenoid Outputs	32
Maximum Addressable I/O Points	Various combinations of 1200 outputs and 1200 inputs

Network Data	
Supported Baud Rates	10 Mbit/100 Mbit
Bus Connector	D-coded 5 Pin M12 type (female)
Diagnostics	Power, short, open load conditions and module health are monitored
Special Features	Integrated web server, fail-safe device settings, HTTP, FTP, and UNICAST (for EtherNet/IP™)

Weight	
EtherNet/IP™ Communications Module	255g/9 oz

EtherNet/IP™ DLR

EtherNet/IP™ used throughout the world to network millions of PCs has now evolved into a viable industrial network. EtherNet/IP™ is an open architecture high-level communication network that meets the demands of today's industrial applications requiring high-speed (10/100 Mbit/s), high-throughput and flexibility. Additionally, EtherNet/IP™ technology can integrate an on-board web server, which can make the node readily accessible to any standard web browser for configuration, testing and even retrieval of technical documentation.

Numatics' G3 EtherNet/IP™ DLR (Device Level Ring) node with integrated display has an embedded switch which allows the unit to be used in simplified networks with linear topology configurations (daisy chain). This technology alleviates the need for an external Ethernet switch device in a single subnet configuration. Additionally, the DLR compatibility allows the node to be used in a fault tolerant "ring" network, when using appropriate EtherNet/IP™ DLR scanners. DLR configuration allows communication recovery from a single point failure on the network ring (e.g. failed network connection or cable).

Numatics G3 EtherNet/IP™ nodes are capable of addressing combinations of up to 1200 outputs and 1200 inputs.

The G3 EtherNet/IP™ nodes have been tested and approved for conformance by the ODVA.

More information about EtherNet/IP™ and the ODVA can be obtained from the following website: www.odva.org.

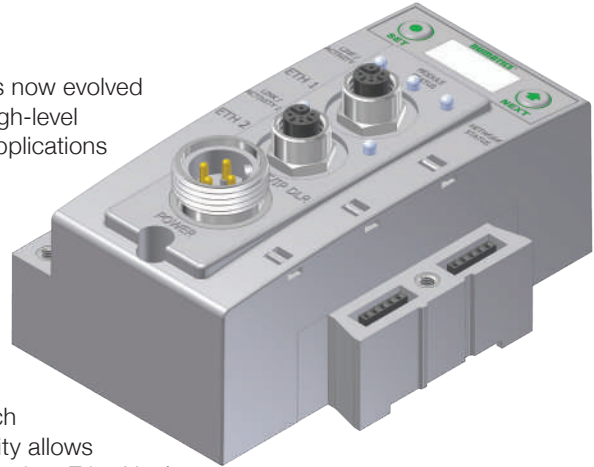

Description	Replacement Part Number
EtherNet/IP™ DLR Communications Module (node)	240-325

Technical Data

Electrical Data	Voltage	Current
Node Power at Max. Brightness	24 VDC +/- 10%	0.0953 Amps
Valves and Discrete I/O	24 VDC +/- 10%	8 Amps Maximum
Power Connector	Single key 4 Pin 7/8" MINI type (male)	
Communication Connector	Two D-coded 4 Pin M12 type (female)	
LEDs	Module Status, Network Status and Activity/Link	

Operating Data	
Temperature Range	-23 °C to 46 °C (-10 °F to 115 °F)
Humidity	95% relative humidity, non-condensing
Vibration/Shock	IEC 60068-2-27, IEC 60068-2-6
Moisture	IP65 (with appropriate assembly and termination)

Configuration Data	
Graphic Display	Display used for setting IP address, Subnet Mask, Fault/Idle Actions, and all other system settings
ARM	(Auto Recovery Module) Optional module that contains automatic recovery of system settings in the event of total or partial system failure
Maximum Valve Solenoid Outputs	128 for 501, 80 for 502/503 and 32 for all other series
Maximum Sub-bus I/O Points	Various combinations of 1200 outputs and 1200 inputs

Network Data	
Supported Baud Rates	10 Mbit/100 Mbit
Bus Connector	Two D-coded 4 Pin M12 type (female)
Diagnostics	Power, short, open load conditions and module health and configuration are monitored
Special Features	Embedded two port switch, Device Level Ring (DLR) compatibility, Linear network topology, QuickConnect™ capability, fail-safe device settings, integrated web server, HTTP, TFTP, UNICAST

Weight	
EtherNet/IP™ DLR Communications Module	227g/8 oz

Ethernet POWERLINK®

Ethernet POWERLINK® is an open fieldbus protocol designed by B&R for communication between automation control systems and distributed I/O at the device level.

Numatics' G3 Ethernet POWERLINK® nodes have an integrated graphic display and are capable of addressing combinations of up to 1200 outputs and 1200 inputs.

The G3 Ethernet POWERLINK® nodes have been designed and tested to conform to the Ethernet POWERLINK® specifications available at EPSG group (Ethernet Powerlink® Standardization Group). The certification process ensures interoperability for all Ethernet POWERLINK® devices and compatibility with B&R systems.

More information regarding Ethernet POWERLINK® can be obtained from the following website:
www.ethernet-powerlink.org.

ETHERNET
POWERLINK®



Description	Replacement Part Number
POWERLINK® Communications Module (node)	240-309

Technical Data

Electrical Data	Voltage	Current
Node Power at Max. Brightness	24 VDC +/- 10%	0.0955 Amps
Valves & Discrete I/O	24 VDC +/- 10%	8 Amps Maximum
Power Connector	Single key 5 Pin 7/8" MINI type (male)	
Communication Connector	Two D-coded 4 Pin M12 type (female)	
LEDs	Module Status, Network Status and Activity/Link	

Operating Data	
Temperature Range (ambient)	-23 °C to 46 °C (-10 °F to 115 °F)
Humidity	95% relative humidity, non-condensing
Vibration/Shock	IEC 60068-2-27, IEC60068-2-6
Moisture Protection	IP65 (with appropriate assembly and termination)

Configuration Data	
Graphic Display	Display used for setting IP Address, Subnet Mask, Fault/Idle Actions, and all other system settings
ARM	(Auto Recovery Module) Optional module that contains automatic recovery of system setting in the event of total or partial system failure
Maximum Valve-Solenoid Outputs	128 for 501, 80 for 502/503 and 32 for all other series
Maximum Addressable I/O Points	Various combinations of 1200 outputs and 1200 inputs

Network Data	
Supported Baud Rates	10 Mbit/100 Mbit
Bus Connector	Two D-coded 4 Pin M12 type (2-Female)
Diagnostics	Power, short, open load conditions and module health and configuration are monitored
Special Features	Integrated web server, Integrated 2 port switch and fail-safe device settings

Weight	
POWERLINK® Communications Module	227g/8 oz

Modbus® TCP/IP

Ethernet used throughout the world to network millions of PCs has now evolved into a viable industrial network. Ethernet is an open architecture high-level communication network that meets the demands of today's industrial applications requiring high-speed (10/100 Mbit/s), high-throughput and flexibility. Additionally, Ethernet technology can integrate an on-board web server, which can make the node readily accessible to any standard web browser for configuration, testing and even retrieval of technical documentation.

Numatics' G3 nodes for Modbus® TCP/IP have an integrated graphic display and are capable of addressing combinations of up to 1200 outputs and 1200 inputs.



Description	Replacement Part Number
Modbus® TCP/IP Communications Module (node)	240-292

Technical Data

Electrical Data	Voltage	Current
Node Power at Max. Brightness	24 VDC +/- 10%	0.0657 Amps
Valves & Discrete I/O	24 VDC +/- 10%	8 Amps Maximum
Power Connector	Single key 4 Pin 7/8" MINI type (male)	
Communication Connector	D-coded 4 Pin M12 type (female)	
LEDs	Module Status, Network Status and Activity/Link	

Operating Data	
Temperature Range (ambient)	-23 °C to 46 °C (-10 °F to 115 °F)
Humidity	95% relative humidity, non-condensing
Vibration/Shock	IEC 60068-2-27, IEC60068-2-6
Moisture Protection	IP65 (with appropriate assembly and termination)

Configuration Data	
Graphic Display	Display used for setting IP Address, Subnet mask, Fault/Idle Actions, DHCP/BootP and all other system settings
ARM	(Auto Recovery Module) Optional module that contains automatic recovery of system setting in the event of total or partial system failure
Maximum Valve-Solenoid Outputs	128 for 501, 80 for 502/503 and 32 for all other series
Maximum Addressable I/O Points	Various combinations of 1200 outputs and 1200 inputs

Network Data	
Supported Baud Rates	10 Mbit/100 Mbit
Bus Connector	D-coded 5 Pin M12 type (female)
Diagnostics	Power, short, open load conditions and module health are monitored
Special Features	Integrated web server, fail-safe device settings, HTTP, FTP, and UNICAST (for EtherNet/IP™)

Weight	
Modbus® TCP/IP Communications Module	255g/9 oz

PROFIBUS™ DP

PROFIBUS™ DP is a vendor-independent, open fieldbus protocol designed for communication between automation control systems and distributed I/O at the device level.

Numatics' G3 nodes for PROFIBUS™ DP have an integrated graphic display and are capable of addressing combinations of up to 1200 outputs and 1200 inputs.

The G3 nodes for PROFIBUS™ DP have been designed and tested to conform to the PROFIBUS™ standard EN50170. Certification has been done by the PROFIBUS™ Interface Center (PIC) according to the guidelines determined by the PROFIBUS™ Trade Organization (PTO). The certification process ensures interoperability for all PROFIBUS™ devices.

More information regarding PROFIBUS™ can be obtained from the following website: www.profibus.com.



Description	Replacement Part Number
PROFIBUS™ DP Communications Module (node)	240-239

Technical Data

Electrical Data	Voltage	Current
Node Power at Max. Brightness	24 VDC +/- 10%	0.0623 Amps
Valves & Discrete I/O	24 VDC +/- 10%	8 Amps Maximum
Power Connector	Single key 5 Pin 7/8" MINI type (male)	
Communication Connector	Single reverse key (B-Coded) 5 Pin M12 type (1 male and 1 female)	
LEDs	Module Status and Network Status	

Operating Data	
Temperature Range (ambient)	-23 °C to 46 °C (-10 °F to 115 °F)
Humidity	95% relative humidity, non-condensing
Vibration/Shock	IEC 60068-2-27, IEC60068-2-6
Moisture Protection	IP65 (with appropriate assembly and termination)

Configuration Data	
Graphic Display	Display used for setting Node Address, Baud Rate, Fault/Idle Actions, and all other system settings
ARM	(Auto Recovery Module) Optional module that contains automatic recovery of system setting in the event of total or partial system failure
Maximum Valve-Solenoid Outputs	128 for 501, 80 for 502/503 and 32 for all other series
Maximum Addressable I/O Points	Various combinations of 1200 outputs and 1200 inputs

Network Data	
Supported Baud Rates	125K Baud, 250K Baud, 500K Baud, with Auto-Baud detection
Bus Connector	Single key 5 Pin 7/8" MINI type (male)
Diagnostics	Power, short, open load conditions and module health are monitored
Special Features	Supports Auto-Device Replacement (ADR) and fail-safe device settings

Weight	
PROFIBUS™ DP Communications Module	227g/8 oz

PROFINET™

PROFINET™ is the innovative open standard for Industrial Ethernet, developed by Siemens and the PROFIBUS® User Organization (PNO). PROFINET™ complies to IEC 61158 and IEC 61784 standards. PROFINET™ products are certified by the PNO user organization, guaranteeing worldwide compatibility.

Numatics' G3 nodes for PROFINET™ IO (PROFINET™ RT) have an integrated graphic display and are capable of addressing combinations of up to 1200 outputs and 1200 inputs.

PROFINET™ is based on Ethernet and uses TCP/IP and IT standards and complements them with specific protocols and mechanisms to achieve Real Time performance.

More information regarding PROFINET™ can be obtained from the following website: www.profibus.com.



Description	Replacement Part Number
PROFINET™ Communications Module (node)	240-240

Technical Data

Electrical Data	Voltage	Current
Node Power at Max. Brightness	24 VDC +/- 10%	0.0903 Amps
Valves & Discrete I/O	24 VDC +/- 10%	8 Amps Maximum
Power Connector	Single key 5 Pin 7/8" MINI type (male)	
Communication Connector	Two D-coded 4 Pin M12 type (female)	
LEDs	Module Status, Network Status and Activity/Link	

Operating Data	
Temperature Range (ambient)	-23 °C to 46 °C (-10 °F to 115 °F)
Humidity	95% relative humidity, non-condensing
Vibration/Shock	IEC 60068-2-27, IEC60068-2-6
Moisture Protection	IP65 (with appropriate assembly and termination)

Configuration Data	
Graphic Display	Display used for setting IP Address, Subnet Mask, Fault/Idle Actions, and all other system settings
ARM	(Auto Recovery Module) Optional module that contains automatic recovery of system setting in the event of total or partial system failure
Maximum Valve-Solenoid Outputs	128 for 501, 80 for 502/503 and 32 for all other series
Maximum Addressable I/O Points	Various combinations of 1200 outputs and 1200 inputs

Network Data	
Supported Baud Rates	10 Mbit/100 Mbit
Bus Connector	Two D-coded 4 Pin M12 type (2-Female)
Diagnostics	Power, short, open load conditions and module health and configuration are monitored
Special Features	Integrated web server, Integrated 2 port switch, fail-safe device settings, and FSU

Weight	
PROFINET™ Communications Module	227g/8 oz

I/O Modules

Digital I/O - Terminal Strip Modules

Description	Part Number
16 PNP Inputs	240-203
16 NPN Inputs	240-204
8 PNP Inputs	240-316
16 PNP Outputs	240-330

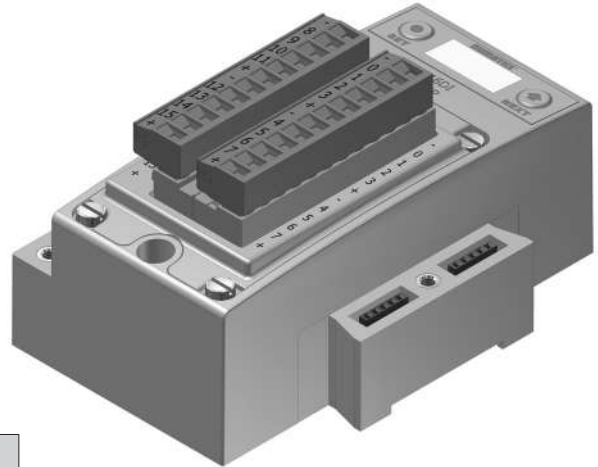

Technical Data

Operating Data	
Temperature Range (ambient)	-23 °C to 46 °C (-10 °F to 115 °F)
Humidity	95% relative humidity, non-condensing
Vibration/Shock	IEC 60068-2-27, IEC60068-2-6
Wire Range	12 to 24 AWG
Strip Length	7mm
Tightening Torque	0.5 Nm
Ingress Protection	IP20

Spare Parts	
Replacement Terminal Strip (I/O 0-7)	140-1073
Replacement Terminal Strip (I/O 8-15)	140-1074
Keying Element for terminal strip	140-1076
Keying Element for Module	140-1077

Weight	
Input Module	292g/10.3 oz

I/O Modules

Digital I/O 5 Pin M12 Modules

Description	Part Number
Inputs	
8 PNP Inputs	240-206
8 NPN Inputs	240-210
16 PNP Inputs	240-205
16 PNP Inputs 19 Pin M23 (Fig. B Only)	240-323
16 NPN Inputs	240-209
Outputs	
8 PNP Outputs	240-208
8 PNP High Current Outputs (Fig. A Only)	240-300
16 PNP Outputs	240-207
Inputs and Outputs	
8 PNP Inputs and 8 PNP Outputs	240-211



Figure A

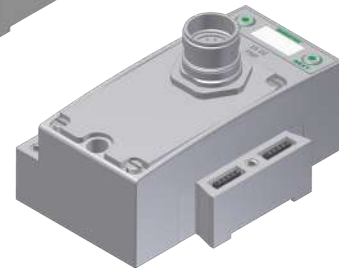

Figure B

**Analog I/O with settable high and low alarms
5 Pin M12 Modules**

Description	Signal Type	Part Number
Inputs		
4 Analog Inputs	0 – 10 VDC	240-212
4 Analog Inputs	4 – 20 mA	240-214
Inputs and Outputs		
2 Analog Inputs & 2 Analog Outputs	0 – 10 VDC	240-213
2 Analog Inputs & 2 Analog Outputs	4 – 20 mA	240-215
2 Analog Inputs & 2 Analog Outputs High Current (Figure A Only)	0 – 10 VDC	240-307
4 Analog Inputs & 4 Analog Outputs High Current (Figure A Only)	4 – 20 mA	240-363



Dust Cover -
M12 Male 230-647

Technical Data

Operating Data	
Temperature Range (ambient)	-23 °C to 46 °C (-10 °F to 115 °F)
Humidity	95% relative humidity, non-condensing
Vibration/Shock	IEC 60068-2-27, IEC60068-2-6
Ingress Protection	IP65 (with appropriate assembly and termination)
Connector-Analog & Digital	M12 4 Pin Female, SPEEDCON® (Compatible with 5 Pin)
Connector-Figure A	M12 4 Pin Male
Connector-Figure B	M23 19 Pin Female
Resolution	16 bit

Weight	
I/O Module-Analog	244g/8.6 oz
I/O Module-Digital	274g/9.7 oz
I/O Module-Figure A	264g/9.3 oz
I/O Module-Figure B	343g/12.1 oz

G3 RTD Temperature Module 240-311

The RTD module is for use with RTD (Resistive Temperature Detectors), supporting up to four RTD devices simultaneously. The module supports various RTD types including: Pt100, Pt200, Pt500, Pt1000, Ni100 and Ni1000.

Technical Data

Electrical Data	
Voltage	24 VDC Module Supply (Via G3 System Aux. Power Connection)
Input Type	RTD (Resistive Temperature Detector), 4 per Module
Supported Sensor Type	Pt100, Pt200, Pt500, Pt1000, Ni100, Ni1000
Supported Temperature Coefficients	.00385; .00392;Ω/°C
Resolution	15 bits plus sign
Data Format	Signed Integer
Calibration	Factory Calibrated Field Calibration w/ high tolerance (± .005%) 100 ohm and 350 ohm resistors.
Input Update (filter) Rate	Adjustable (5 – 20ms), factory default: 5ms
Accuracy	0.1% of full scale @ 25 °C
Mechanical Data	
I/O Connector	M12 4 Pin Female. SPEEDCON® (Compatible with 5 Pin)
Mass	247g/8.7 oz
Operating Data	
Temperature Range Ambient	-23 °C to 46 °C (-10 °F to 115 °F)
Humidity	95% relative humidity: non-condensing
Ingress Protection	IP65 (with appropriate assembly and terminations)



G3 [Ex ia] NAMUR Input Module 240-320

The [Ex ia] module is for use with NAMUR certified intrinsically safe (IS) sensors.

Technical Data

Electrical Data	
Voltage	24 VDC Module Supply Sensor Supply = 8.2 VDC Nominal
Input Type	NAMUR Signal Current (0) ≥ 2.1 mA Signal Current (1) ≤ 1.2 mA Short Circuit Monitoring < 100 Ω Open/Broken Wire Detection < 0.05 mA
NC (Normally Closed)	
Safety Parameter Output Maximums	Uo ≤ 9.6 V Io ≤ 13 mA Po ≤ 31 mW
Diagnostics	Open (broken wire) and Short Circuit
Certification	
Module Marking (ATEX)	 II(1)GD [Ex ia Ga] IIC [Ex ia Da] IIIC
Mechanical Data	
I/O Connector	M12 4 Pin Female SPEEDCON® (Compatible with 5 Pin)
Mass	284g/10.0 oz
Operating Data	
Temperature Range Ambient	-23 °C to 46 °C (-10 °F to 115 °F)
Humidity	95% relative humidity: non-condensing
Ingress Protection	IP65 (with appropriate assembly and terminations)



Sub-bus Modules

Sub-bus Valve Module

Provides Sub-bus In and Aux. Power In connections to a distributed valve manifold.

Description	Part Number	Weight
Sub-bus Valve Module w/ I/O	240-241	235g/8.3 oz
Sub-bus Valve Module w/o I/O*	P580AEDS4010A00	320g/11.3 oz
Sub-bus Valve Module w/o I/O, w/ DIN Rail Clips*	P580AEDS4010DRM	332g/11.7 oz

*500 Series only

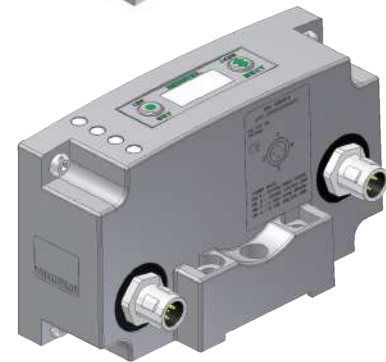
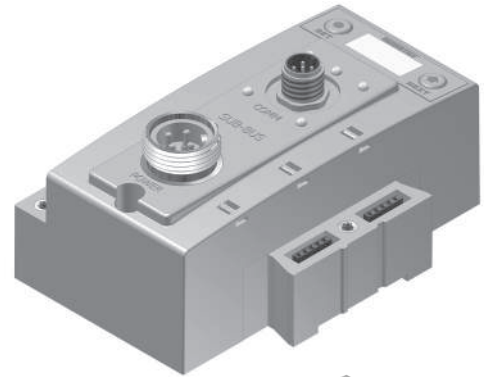

Sub-bus Out Module

Provides Sub-bus Out and Aux. Power Out connections for I/O distribution.

Description	Part Number	Weight
Sub-bus Out Module w/ DIN Rail Clips	240-244	141g/5.0 oz
Sub-bus Out Module	240-183	130g/4.6 oz
Sub-bus Out Module for Intrinsically Safe	240-318	150g/5.3 oz

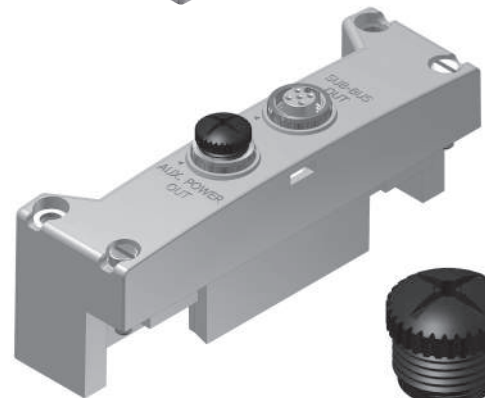

Dust Cover - M12 Male 230-647

Sub-bus In Module

Provides Sub-bus In and Aux. Power In connections for I/O distribution.

Description	Part Number	Weight
Sub-bus In Module w/ DIN Rail Clips	240-246	141g/5.0 oz
Sub-bus In Module	240-185	130g/4.6 oz
Sub-bus In Module for Intrinsically Safe	240-318	150g/5.3 oz

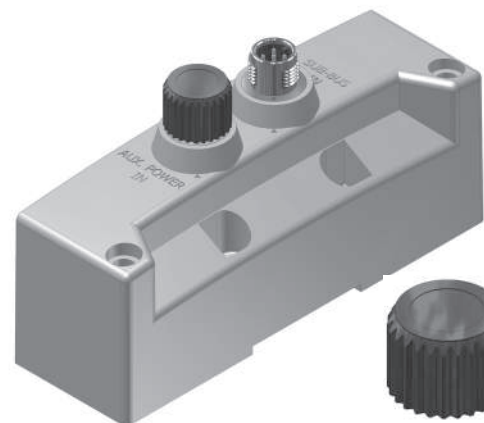

Dust Cover - M12 Female 230-1200

G3 4 Branch Sub-bus HUB Module 240-326

The G3 HUB module allows for branch distribution from the I/O side of the G3 System and can be integrated into the existing G3 Series Sub-bus configuration. Auto Addressing allows for trouble free set up and configuration. Input, output, as well as Valve manifolds can be attached to the available four Branches on a HUB module. Each G3 System can support up to two HUB modules, allowing for maximum flexibility. The HUB module is transparent to the I/O side of the G3 and does not reserve one of the potential sixteen positions.

As with all other G3 I/O modules, standard G3 display and ARM functionality (storing of all parameters) is supported.



Technical Data

Electrical Data	
Voltage	24 VDC Module Supply
No. of HUB Branches	4 Per HUB Module, 2 HUB Modules per G3 System (A HUB module cannot be connected to the Branch of another HUB module)
HUB Branch Length	30 Meters Per Branch
Addressing	Auto Addressing on Power Up (Branch I/O reserve capability)
Display/Diagnostics	Onboard LCD Multi Function Display
G3 System Integration	Integrated into existing G3 I/O Side
Topology	Star, Tree and Hybrid

Mechanical Data	
Branch Connector	M12 5 Pin Female
Mass	255g/9.0 oz

Operating Data	
Temperature Range	-23 °C to 46 °C (-10 °F to 115 °F)
Humidity	95% relative humidity: non-condensing
Ingress Protection	IP65 (with appropriate assembly and terminations)

Miscellaneous Modules

Auto Recovery Module (ARM)

Protects configuration information during a critical failure. Allows configuration information to be saved and reloaded to replacement module automatically.

Description	Part Number	Weight
ARM Module	240-182	127g/4.5 oz



Terminator Module

Provides termination for the Sub-bus. Must be installed after the last I/O module or after the communications module if there are no I/O modules installed.

Description	Part Number	Weight
Terminator Module w/ DIN Rail Clips	240-245	102g/3.6 oz
Terminator Module	240-184	91g/3.2 oz

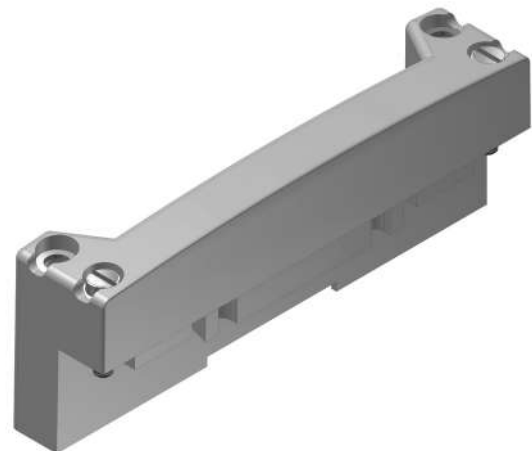

Jumper Clip

Provides electrical connections between modules.

Description	Part Number	Weight
Jumper Clip	240-179	45g/1.6 oz
Jumper Clip for Intrinsically Safe	240-317	65g/2.3 oz



Miscellaneous Modules

Valve Driver Module

Provides connections between the communication module or Sub-bus valve module and the valve manifold.

Generation 2000, ISO 5599/2 and ISO 15407-2 Series

Description	Part Number	Weight
Valve Driver Module w/ DIN Rail Clips	219-858	147g/5.2 oz
Valve Driver Module	219-828	136g/4.8 oz

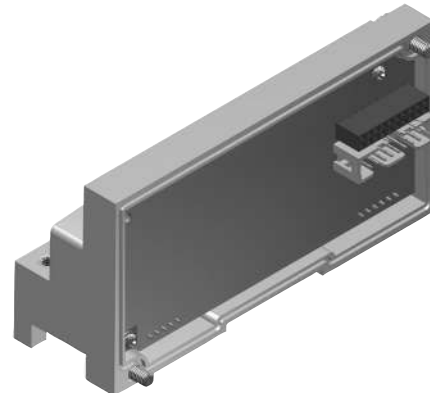

501, 502 and 503 Series Valves

Description	Part Number	Weight
Valve Driver Module	P599AE508827001	234g/8.3 oz
Valve Driver Module w/ DIN Rail Clips	P599AE508827002	246g/8.7 oz

Right Hand Mounting Cover

Used when a communications module is used without local valves installed.

Description	Part Number	Weight
Right Hand Mounting Cover w/ DIN Rail Clips*	240-289	82g/2.9 oz
Right Hand Mounting Cover*	240-255	71g/2.5 oz
Right Hand Mounting Cover Assembly Kit for ARM	245-189	371g/13.1 oz

* Not for use in combination with ARM Module

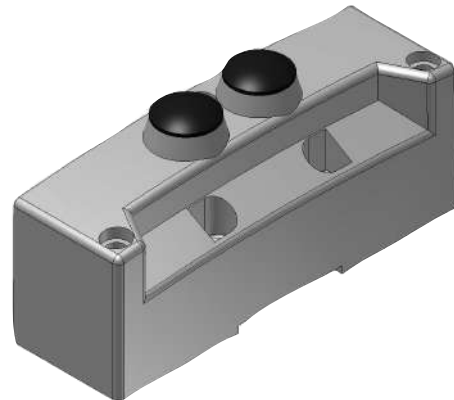

Accessories

For use with Murrplastik® Type 20 Software.

Labels - 122-1251

Technical Data	
Material	Polycarbonate (PC)
Color	White
Temperature Range	-40 °C to 140 °C (-40 °F to 284 °F)
Label Dimensions	0.19" x 0.39"
Label - Printable Area	0.19" x 0.39"

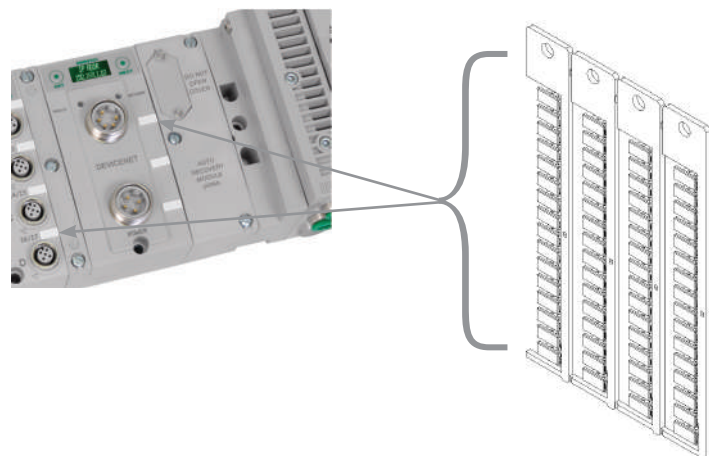

Dimensions: mm (inches)

G3 Fieldbus Manifold Assembly

503 Series Valve Manifold Assembly with G3 Electronics and Sub-bus Output

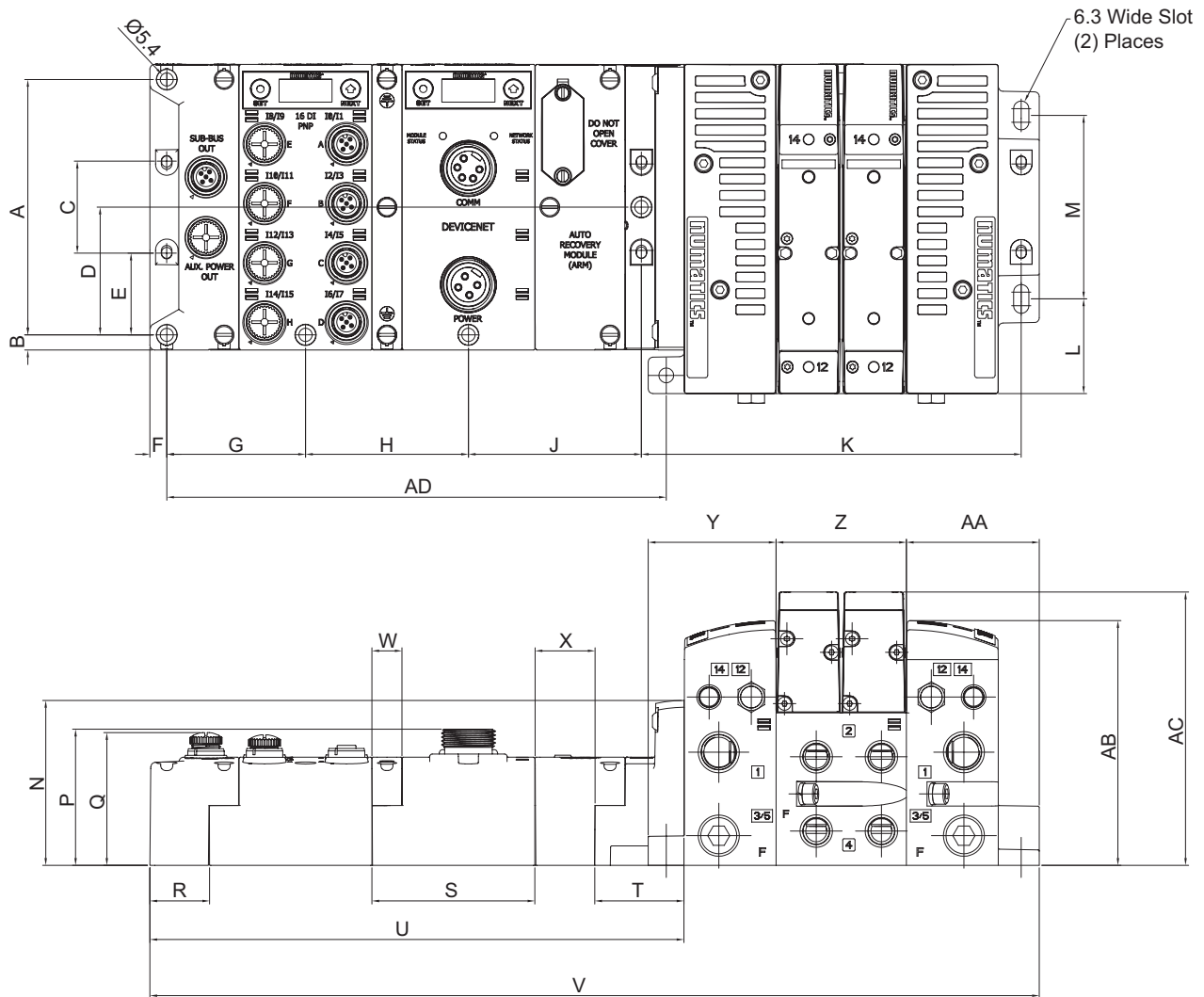

A	B	C	D	E	F	G	H	J	K	L	M	N	P
105.5 (4.154)	6.3 (0.248)	38 (1.5)	52.8 (2.08)	33.8 (1.33)	7 (0.28)	57.5 (2.264)	67.5 (2.66)	71.7 (2.82)	-	39.1 (1.54)	75.8 (2.984)	68.1 (2.68)	56.3 (2.217)
Q	R	S	T	U	V	W	X	Y	Z	AA	AB	AC	AD
54 (2.13)	24.8 (0.98)	67.5 (2.66)	36.9 (1.45)	221.3 (8.713)	368.6 (14.51)	12.5 (0.49)	24.8 (0.976)	53 (2.087)	-	55.1 (2.17)	101.1 (3.98)	112.9 (4.445)	207 (8.2)

NOTE: For valve manifold dimensions refer to valve series product catalogs.

Dimensions: mm (inches)

G3 Fieldbus I/O Assembly

I/O Assembly with G3 Electronics and Sub-bus Input

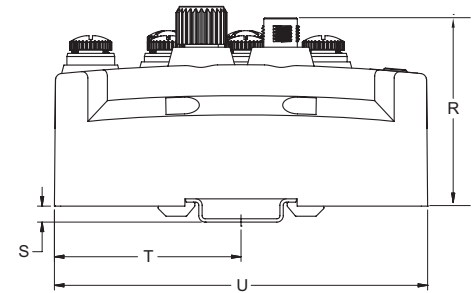
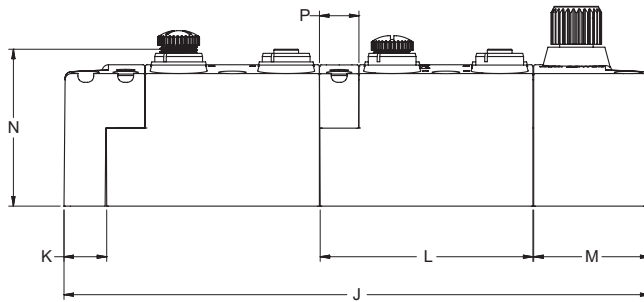
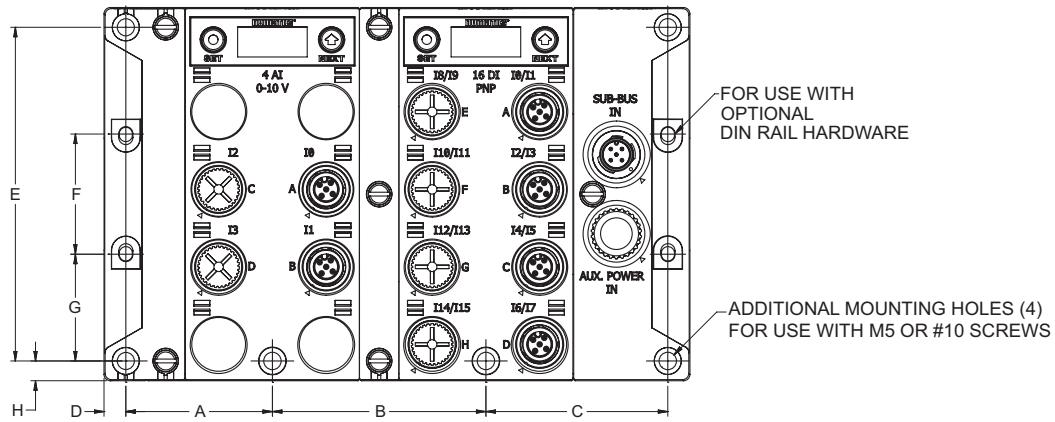

VIEW SHOWN WITH OPTIONAL DIN RAIL HARDWARE AND 35mm DIN RAIL

A	B	C	D	E	F	G	H	J	K	L	M	N	P	R	S	T	U
46.35 (1.82)	67.50 (2.66)	57.50 (2.26)	6.90 (0.27)	105.50 (4.15)	38.00 (1.50)	33.75 (1.33)	6.25 (0.25)	185.25 (7.29)	13.50 (0.53)	67.25 (2.65)	36.75 (1.45)	54.00 (2.13)	12.50 (0.49)	62.50 (2.46)	5.05 (0.20)	59.00 (2.32)	118.00 (4.65)



How To Order: 500 Series Manifold Assembly

K 501 A V 3 D 2 0 0 V A00

Port Type

¹ 8 = NPTF
¹ G = ISO228/1-G
 K = Push-in Fittings

Product Series

501 = 11mm Valve
 502 = 18mm Valve
 503 = 26mm Valve

Revision

A = Initial Release

Product Type

V = Valve Manifold Assembly

Electronics

3 = G3 Fieldbus Electronics
 8 = Sub-bus Valve Manifold w/o I/O

Number of Valve Stations

A = NA/33/65/97	Q = 17/49/81/113
B = 2/34/66/98	R = 18/50/82/114
C = 3/35/67/99	S = 19/51/83/115
D = 4/36/68/100	T = 20/52/84/116
E = NA/37/69/101	U = 21/53/85/117
F = 6/38/70/102	V = 22/54/86/118
G = 7/39/71/103	W = 23/55/87/119
H = 8/40/72/104	X = 24/56/88/120
I = 9/41/73/105	Y = 25/57/89/121
J = 10/42/74/106	Z = 26/58/90/122
K = 11/43/75/107	2 = 27/59/91/123
L = 12/44/76/108	3 = 28/60/92/124
M = 13/45/77/109	4 = 29/61/93/125
N = 14/46/78/110	5 = 30/62/94/126
O = 15/47/79/111	6 = 31/63/95/127
P = 16/48/80/112	7 = 32/64/96/128

Options

A00 = Standard (No Options)
 MUF = Muffler in End Plates
 DRM = DIN Rail Mount
 DWM = DIN Rail with MUF
 14X = External Pilot Supply from Port # 14
 D12 = (14X) External Pilot Supply from Port #14 and (MUF) Muffler in End Plates
 D14 = (14X) External Pilot Supply from Port #14 and (DRM) DIN Rail Mount
 F06 = (14X) External Pilot Supply from Port #14, (MUF) Muffler in End Plates, and (DRM) DIN Rail Mount

End Plate Style

V = Vertical

Second Valve Series

0 = No Second Valve Series
 1 = 501
 2 = 502

Valve Station Adder

0 = No Adder
 1 = 32+
 2 = 64+
 3 = 96+

Port Size

1 = 1/8
 2 = 1/4
 G = 5/16
 3 = 3/8
 4 = 1/2
 H = 8mm
 K = 10mm
 M = 12mm

¹ Port Type 8 & G only available in Port Size 3/8 for 502 & 503 and 1/8 for 501

² 501 not available with 2 stations, 502 and 503 only available with an even number of stations and with up to 80 valve solenoids

³ With 502 11mm (501) valve available, with 503 18mm (502) valve available

⁴ 501 Port Sizes 1/8, 1/4, 5/16, 8mm, 502 and 530 Port Sizes 3/8, 1/2, 10 and 12mm

How to Order: Sub-bus Valve Manifold without I/O or Additional Distribution

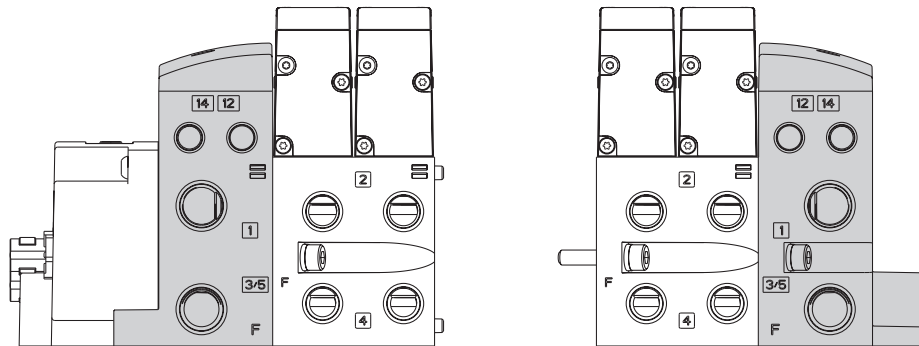

Shaded components are described by the manifold assembly number. The communications module is described by the electronic interface model number designation.

Each valve station is listed in sequential order from left to right when facing the port side of the manifold as shown.

NOTE:

Up to 128 solenoid outputs are available. Either 128 single solenoid valves or 64 double solenoid valves or any combination of singles and doubles not to exceed 128 outputs can be specified.

Example Order - 503 Shown

Assembly Kit	8503AV8H300VMUF
Valve Station #1	R503A2B40MA00F1
Valve Station #2	R503A2B40MA00F1
Mounting #1	8503AMM22MA0010
Valve Station #3	R503A2B40MA00F1
Valve Station #4	R503A2B40MA00F1
Mounting #2	8503AMM22MA0010
Valve Station #5	R503A2B40MA00F1
Valve Station #6	R503A2B40MA00F1
Mounting #3	8503AMM22MA0010
Valve Station #7	R503A2B40MA00F1
Valve Station #8	R503A2B40MA00F1
Mounting #4	8503AMM22MA0010
Electronics	P580AEDS4010A00
	Assembled

How To Order: 2000 and ISO Series Manifold Assembly

A K 3 E D 0 0 0 0 3 L STD

Electrical/Electronic Type & Location
3 = G3 Electronics

*** Valve Series**

- 0 = N/A
- 6 = 2002 - 02/R2
- E = 2005
- G = 2012
- B = 2035
- W = ISO 15407-2 18mm
- X = ISO 15407-2 26mm
- Q = ISO 5599/2 Size 1
- R = ISO 5599/2 Size 2
- S = ISO 5599/2 Size 3

Number of Valve Stations

A = 1	I = 9	Q = 17	Y = 25
B = 2	J = 10	R = 18	Z = 26
C = 3	K = 11	S = 19	2 = 27
D = 4	L = 12	T = 20	3 = 28
E = 5	M = 13	U = 21	4 = 29
F = 6	N = 14	V = 22	5 = 30
G = 7	O = 15	W = 23	6 = 31
H = 8	P = 16	X = 24	7 = 32

Special Options

- STD = Standard
- DRM = DIN Rail Mounting - Not available w/ 2035 and ISO 5599/2
- MUF = Muffler - Not available with ISO 5599/2
- DWM = DIN Rail w/ Muffler - Not available w/ 2035 and ISO 5599/2

End Plate Port Type

- L = Push-in Fitting
- N = NPTF Pressure Ports (NPTF Conduit Ports if applicable)
- G = ISP 228/1-G Tap Pressure Ports (ISO 228/1-G Conduit Ports if applicable)

End Plate Port Size

- 2 = 1/4
- 3 = 3/8
- 4 = 1/2
- 6 = 1
- 8 = 8mm (5/16)
- K = 10mm
- X = Two or more valve groups resulting in different standard end plate port sizes

*For manifold assembly with multiple valve series - consult factory

How To Order

G3 Electronics

G3 EP1 00 R 0 STD

Series
G3 = G3 Electronics

Electronics Protocol

- CC1 = CC-Link IE Field
- CO1 = CANopen
- DL1 = DeviceLogix
- DN1 = DeviceNet
- EC1 = EtherCAT
- ED1 = EtherNet/IP DLR
- EM1 = Ethernet Modbus TCP/IP
- EP1 = EtherNet/IP
- PL1 = Ethernet POWERLINK
- PT1 = PROFIBUS™ DP
- PN1 = PROFINET™
- DS2 = Sub-bus Valve Manifold
- DS3 = Sub-bus I/O Assembly

Number of I/O Modules

00 = 0	09 = 9
01 = 1	10 = 10
02 = 2	11 = 11
03 = 3	12 = 12
04 = 4	13 = 13
05 = 5	14 = 14
06 = 6	15 = 15
07 = 7	16 = 16
08 = 8	

Options

- STD = Standard
- DRM = DIN Rail Mounting
- E23 = Fieldbus Assembly without Valves
- E40 = Auto Recovery Module (ARM)
- G32 = E40 + DRM
- G36 = E28 + E40

Modification

- 0 = Initial Release

Left Mounting

- D = w/ Sub-bus Out
- R = w/ Terminating Resistor

How to Order: Valve Manifold Assemblies w/ G3 Electronics & Discrete I/O

For valve series 2002, 2005, 2012, 2035, ISO 15407-2 & ISO 5599/2 (2005 shown)

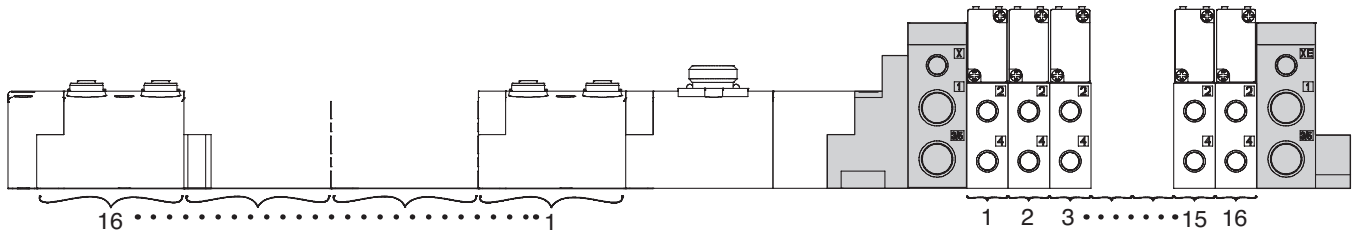

Shaded components are described by the assembly kit (AK) model number (see previous page). The communications module and number of I/O modules are described by the electronic interface (G3) model number designation (see previous page).

Each valve station is listed in sequential order from left to right when facing the port side of the manifold as shown.

Each discrete I/O module is listed in sequential order from RIGHT to LEFT starting from the communication module as shown.

NOTE:

1. A total of 32 solenoid outputs are available. Either 32 single solenoid valves or 16 double solenoid valves or any combination of singles and doubles not to exceed 32 outputs can be specified.
2. For manifold assemblies that exceed 16 solenoids, the assembly MUST be configured so that an even number of solenoids are utilized prior to the station using the ribbon cable feature. The 16th and the 17th solenoids cannot be on the same valve.

Example Order - 2005 Shown

Assembly Kit	AK3EP00003LMUF
Station 1	052BB4Z2ML00061
Station 2	052BB4Z2ML00061
Station 3	052BB4Z2ML00061
Station 4	052BB4Z2ML00061
Station 5	052BB4Z2ML00061
Station 6	052BB4Z2ML00061
Station 7	052BB4Z2ML00061
Station 8	052BB4Z2ML00061
Station 9	052BB4R2ML00061
Station 10	052BB4Z2ML00061
Station 11	052BB4Z2ML00061
Station 12	052BB4Z2ML00061
Station 13	052BB4Z2ML00061
Station 14	052BB4Z2ML00061
Station 15	052BB4Z2ML00061
Station 16	052BB4Z2ML00061
Electronics	G3DN116R0E40
Station 1	240-205
Station 2	240-205
⋮	
Station 15	240-205
Station 16	240-205

How To Order

G3 Electronics

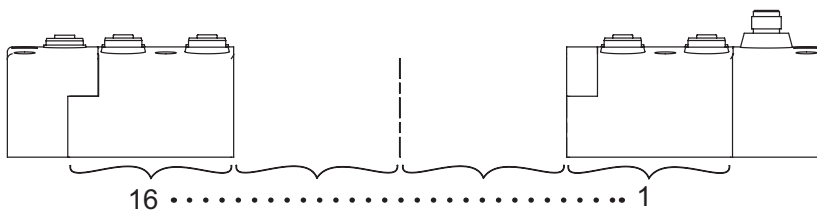

1. Refer to the selection table on the previous page to specify the control electronics and I/O configuration.
2. Each discrete I/O module is listed in sequential order from RIGHT to LEFT as shown.
3. A maximum of 16 I/O modules are supported by a single communication node. Analog I/O & digital I/O (NPN & PNP)

Example Order - I/O Assembly w/ Sub-bus In and Sub-bus Out Modules Shown

Electronics	G3DS316D0STD
Station 1	240-205
Station 2	240-205
⋮	
Station 15	240-205
Station 16	240-205

501 Series – Directional Control Valve Platform Featuring Higher Flow in a Compact Valve Package



Features

- Solenoid air pilot actuated
- Low wattage 0.8 Watt for DC application
- DC solenoids Polarity insensitive with surge suppression
- Plug together circuit boards eliminate internal wiring
- Integral recessed gaskets
- IN Fittings to accommodate various tube sizes
- Simple conversion from internal to external pilot
- IP65 Certified

Sandwich and Manifold Accessories

- Pressure Regulators for supply pressure control at individual valve
- Speed control to control exhaust flow allows for control of actuator extend or retract speed
- Shut off block for individual valve to be isolated from pressure supply during operation and repair
- Mid Station Supply Manifold block allows for multiple pressure zones (with blocking discs) or additional air supply to a manifold





Fieldbus Electronics Compatible

- G3 Fieldbus Electronics
 - Graphic Display for easy commissioning, visual status & diagnostics
 - 128 valve solenoids per manifold
 - Easy distribution of additional manifolds through Sub-bus communication
 - One Node supports up to 16 I/O modules
 - Available with Auto Recovery Module (ARM) which allows configuration information to be saved and reloaded to replacement module automatically
- 580 Fieldbus Electronics
 - Graphic Display for easy commissioning, visual status & diagnostics
 - 128 valve solenoids per manifold

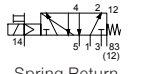

501 PERFORMANCE
& HOW TO ORDER

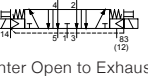
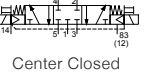
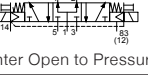
Performance Data

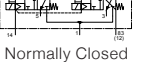
Function Type	Function Code	ISO Symbol Pilot (14) Return (12)	Interface	Rated Flow		Response Time (ms)	Pilot Pressure at 73°F/23°C PSI (bar)		Operating Pressure Port 1 PSI (bar)/inHg (-bar)		 Part Number
				at 90 PSI Cv (l/min (ANR))			min.	max	min.	max	
				1 → 2 1 → 4	2 → 3 4 → 5	Energize/ De-Energize					
Rubber Packed Technology, with Manual Override											
5/2	B1	 Spring Return	Proprietary	0.460 (460)	0.465 (465)	14/29	29 (2)	115 (8)	28 (-0.95)	115 (8)	R501A2B10MA00F1
	BN	 Differential Air Return		0.460 (460)	0.465 (465)	25/21	29 (2)	115 (8)	28 (-0.95)	115 (8)	R501A2BN0MA00F1
	B4	 Solenoid Air Return		0.460 (460)	0.465 (465)	11/11	29 (2)	115 (8)	28 (-0.95)	115 (8)	R501A2B40MA00F1
5/3	B5	 Center Open to Exhaust		0.420 (420)	0.470 (470)	27/12	29 (2)	115 (8)	28 (-0.95)	115 (8)	R501A2B50MA00F1
	B6	 Center Closed		0.460 (460)	0.465 (465)	13/12	29 (2)	115 (8)	28 (-0.95)	115 (8)	R501A2B60MA00F1
	B7	 Center Open to Pressure		0.460 (460)	0.411 (411)	17/38	36 (2.5)	115 (8)	28 (-0.95)	115 (8)	R501A2B70MA00F1
2 x 3/2 NO	BA	 Normally Open		0.450 (450)	0.450 (450)	18/18	0.3 x Operating Pressure + 13 PSI		30 (2)	115 (8)	R501A2BA0MA00F1
2 x 3/2 NC	BD	 Normally Closed		0.460 (460)	0.470 (470)	18/18	0.09 x Operating Pressure + 33.5 PSI		30 (2)	115 (8)	R501A2BD0MA00F1

Construction

Materials in Contact w/Fluid	
Body	Aluminum, E-Coating treatment
Spool	Aluminum or Stainless Steel
Piston	POM
Spring	Steel
Spool Seals	NBR + PUR
Other Seals	NBR + FKM
Other materials	PAM (Polyarylamide) 50% Glass Fiber Reinforced
Valve to Subbase Gasket	NBR
Subbases	Aluminum, E-Coating treatment

Operating Data

All Solenoids Are Continuous Duty Rated	24 VDC
Power (Watts)	0.8
Holding Current (Amps)	0.025
Ambient Temperature Range Min/Max °F (°C)	-14° F (-10° C)/122° F (50° C)

How to Order: Valve

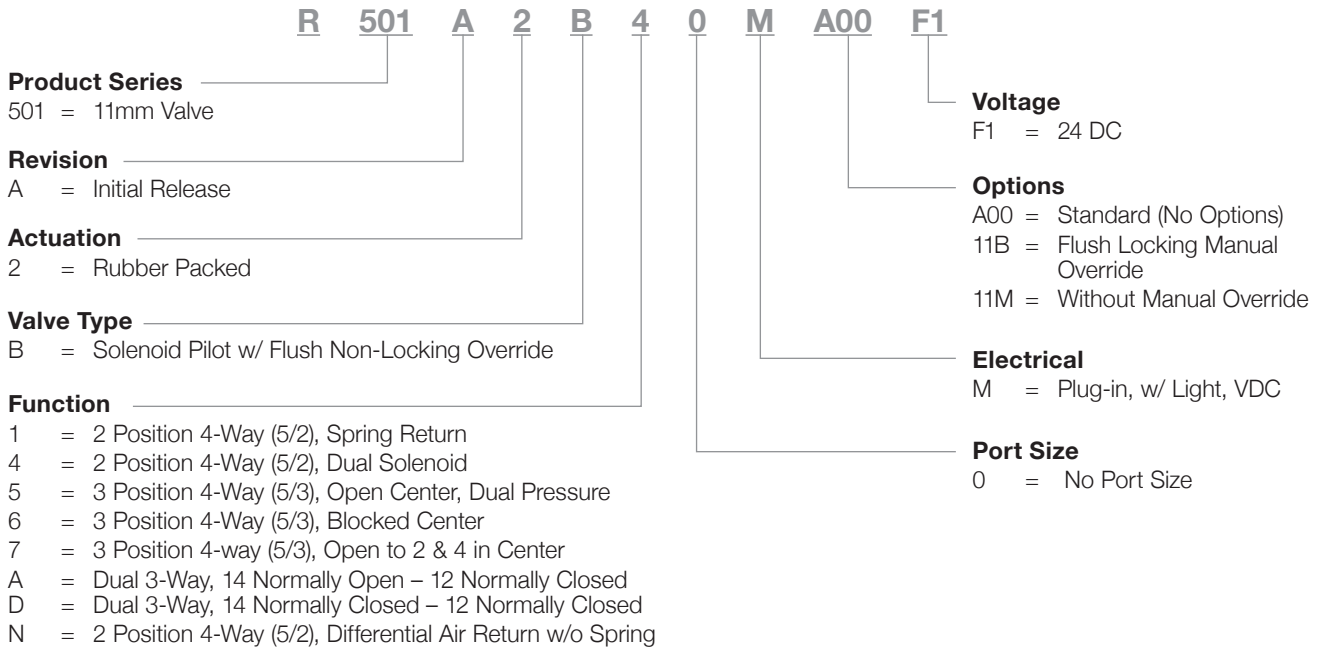

How to Order: Regulator

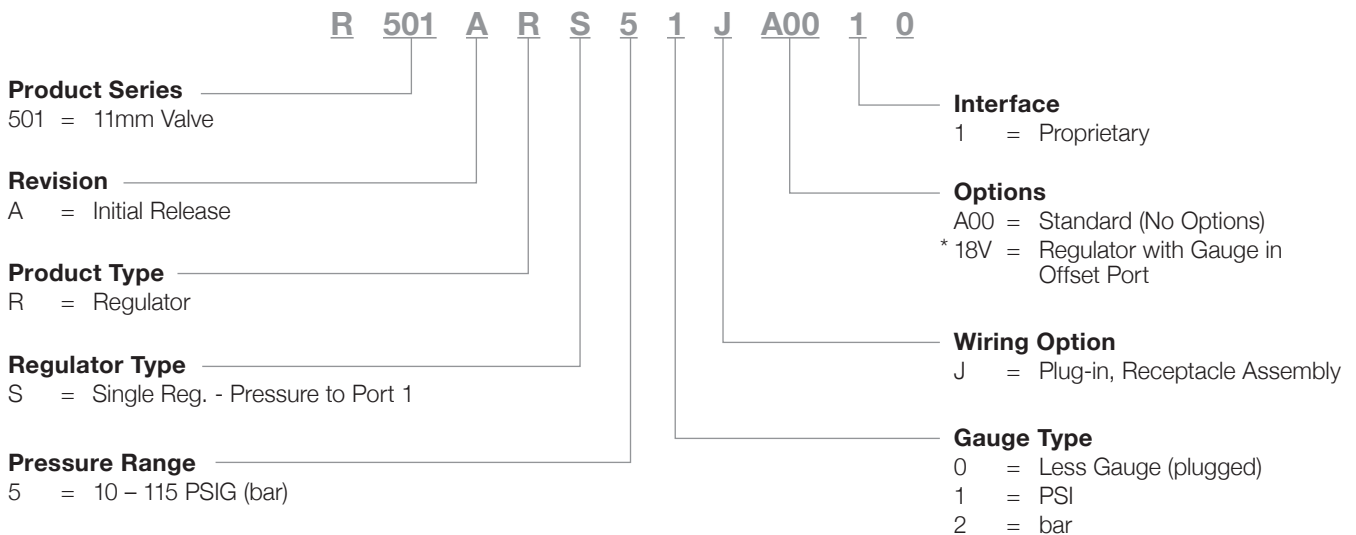

* Regulator gauges must be offset with 18V option on alternating stations to prevent interference.

**502 Series – Directional Control Valve Platform
Featuring Higher Flow in a Compact Valve Package**



ISO 15407-2 (18mm)
ISO 15407-1 (18mm)

Features

- Solenoid air pilot actuated
- Low wattage 1.3 Watt for DC application
- DC solenoids Polarity insensitive with surge suppression
- Plug together circuit boards eliminate internal wiring
- Integral recessed gaskets
- IN Fittings to accommodate various tube sizes
- Simple conversion from internal to external pilot
- IP65 Certified

Sandwich and Manifold Accessories

- Pressure Regulators for supply pressure control at individual valve
- Speed control to control exhaust flow allows for control of actuator extend or retract speed
- Shut off block for individual valve to be isolated from pressure supply during operation and repair
- Mid Station Supply Manifold block allows for multiple pressure zones (with blocking discs) or additional air supply to a manifold

Fieldbus Electronics Compatible

- G3 Fieldbus Electronics
 - Graphic Display for easy commissioning, visual status & diagnostics
 - 80 valve solenoids per manifold
 - Easy distribution of additional manifolds through Sub-Bus communication
 - One Node supports up to 16 I/O modules
 - Available with Auto Recovery Module (ARM) which allows configuration information to be saved and reloaded to replacement module automatically
- 580 Fieldbus Electronics
 - Graphic Display for easy commissioning, visual status & diagnostics
 - 80 valve solenoids per manifold

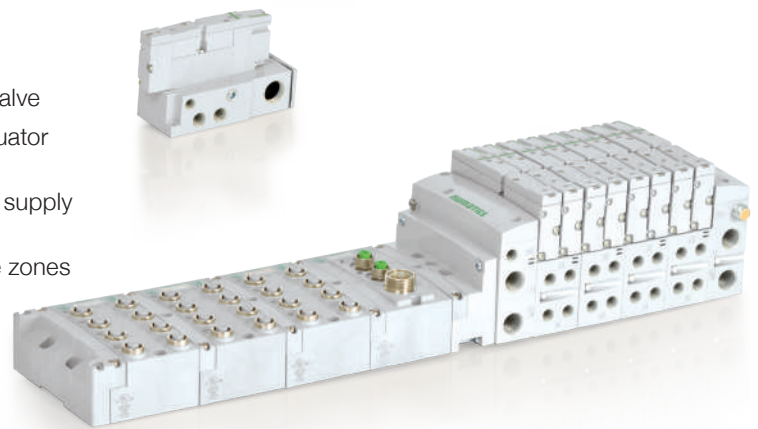

502 PERFORMANCE & HOW TO ORDER

Performance Data

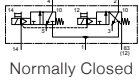
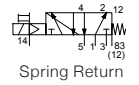
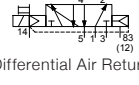
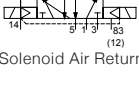
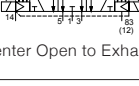
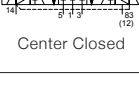
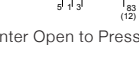
Function Type	Function Code	ISO Symbol Pilot (14) Return (12)	Interface	Rated Flow		Response Time (ms)	Pilot Pressure at 73°F/23°C PSI (bar)		Operating Pressure Port 1 PSI (bar)/inHg (-bar)		Part Number
				at 90 PSI Cv (l/min (ANR))			min.	max	min.	max	
				1 → 2 1 → 4	2 → 3 4 → 5	Energize/ De-Energize					
Rubber Packed Technology, with Manual Override											
2 x 3/2 NC	BD	 Normally Closed	Proprietary	0.650 (650)	0.600 (600)	36/15	58 (4.0)	115 (8)	36* (2)	115 (8)	R502A2BD0MA00F1
			ISO	0.500 (500)	0.440 (440)						
Spool and Sleeve Technology, with Manual Override											
5/2	B1	 Spring Return	Proprietary	0.470 (470)	0.530 (530)	16/49	29 (2)	115 (8)	28 (-0.95)	115 (8)	R502A1B10MA00F1
			ISO	0.410 (410)	0.390 (390)						
	BN	 Differential Air Return	Proprietary	0.470 (470)	0.530 (530)	11/26	22 (1.5)	115 (8)	28 (-0.95)	115 (8)	R502A1BN0MA00F1
			ISO	0.410 (410)	0.390 (390)						
	B4	 Solenoid Air Return	Proprietary	0.470 (470)	0.530 (530)	12/15	29 (2)	115 (8)	28 (-0.95)	115 (8)	R502A1B40MA00F1
			ISO	0.410 (410)	0.390 (390)						
5/3	B5	 Center Open to Exhaust	Proprietary	0.380 (380)	0.500 (500)	23/13	22 (1.5)	115 (8)	28 (-0.95)	115 (8)	R502A1B50MA00F1
			ISO	0.340 (340)	0.350 (350)						
	B6	 Center Closed	Proprietary	0.420 (420)	0.440 (440)	12/12	22 (1.5)	115 (8)	28 (-0.95)	115 (8)	R502A1B60MA00F1
			ISO	0.360 (360)	0.350 (350)						
	B7	 Center Open to Pressure	Proprietary	0.420 (420)	0.430 (430)	13/23	22 (1.5)	115 (8)	28 (-0.95)	115 (8)	R502A1B70MA00F1
			ISO	0.370 (370)	0.350 (350)						

* Minimum pressure with external piloting

Construction

Materials in Contact w/Fluid	
Body	Aluminum, E-Coating treatment
Spool	Aluminum or Stainless Steel
Piston	POM
Spring	Steel
Spool Seals	NBR + PUR
Other Seals	NBR + FKM
Other materials	PAM (Polyarylamide) 50% Glass Fiber Reinforced
Valve to Subbase Gasket	NBR
Subbases	Aluminum, E-Coating treatment

Operating Data

All Solenoids Are Continuous Duty Rated	24 VDC
Power (Watts)	1.3
Holding Current (Amps)	0.054
Ambient Temperature Range Min/Max °F (°C)	-14 °F (-10 °C)/122 °F (50 °C)

How to Order: Valve

R 502 A 1 B 4 0 M A00 F1

Product Series
502 = 18mm Valve

Revision
A = Initial Release

Actuation
1 = Spool and Sleeve
2 = Rubber Packed

Valve Type
B = Solenoid Pilot with Flush Non-Locking Override

Function
1 = 2 Position 4-Way (5/2), Spring Return
4 = 2 Position 4-Way (5/2), Dual Solenoid
5 = 3 Position 4-Way (5/3), Open Center, Dual Pressure
6 = 3 Position 4-Way (5/3), Blocked Center
7 = 3 Position 4-way (5/3), Open to 2 & 4 in Center
D = Dual 3-way, 12 Normally Closed - 14 Normally Closed

Voltage
F1 = 24 DC

Options
A00 = Standard (No Options)
11B = Flush Locking Manual Override
11M = Without Manual Override

Electrical
M = Plug-in, w/Light, VDC
3 N = M12 Connector
Pin 1 = Not Used; Pin 2 = Coil 12;
Pin 3 = Common; Pin 4 = Coil 14

Port Size
0 = No Port Size

¹ Not available with Function D
² Available with Function D only
³ See diagram:

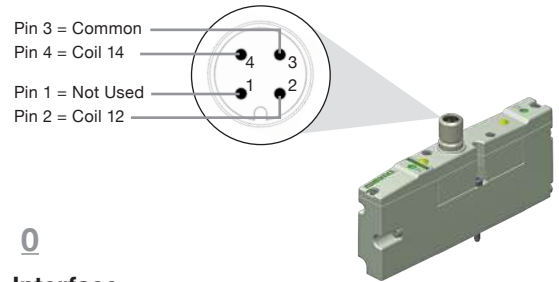

Regulator

R 502 A R S 1 1 J A00 1 0

Product Series
502 = 18mm Valve

Revision
A = Initial Release

Product Type
R = Regulator

Regulator Type
S = Single Reg. - Pressure to Port 1
D = Double Reg. - Pressure to Ports 5 & 3
E = Double Reg. - Pressure to Ports 4 & 2, w/o Valve
T = Double Reg. - Pressure to Ports 1 & 3, 2 Pressure Selector

Pressure Range
1 = 10 - 130 PSIG (0.7 - 9 bar)
3 = 3 - 30 PSIG (0.2 - 2 bar)
4 = 5 - 60 PSIG (0.3 - 4.1 bar)

Interface
1 = Proprietary
2 = ISO 15407-2
3 = ISO 15407-1

Options
A00 = Standard (No Options)
14M = Temperproof Needle Cartridge Assembly or Regulator
16N = Jumper for Supply Pressure to Valve, 14 End
16P = Jumper for Supply Pressure to Valve, 12 End
* 61Y = Regulator with Gauge Extension Fitting

Wiring Option
J = Plug-in, Receptacle Assembly
0 = Non Plug-in

Gauge Type
1 = PSI
2 = bar
8 = with 1/8" NPTF adaptor for external gauge
G = with 1/8" G tap adaptor for external gauge

* Regulator gauges must be offset with 61Y option on alternating stations to prevent interference.

503 Series – Directional Control Valve Platform

Featuring Higher Flow in a Compact Valve Package

Features

- 5 Ported, 2 and 3 position, 4-way, Spool & Sleeve and Rubber Seal, Cv: 1.2 - 1.4
- Solenoid air pilot actuated
- Low wattage 1.7 Watt for DC application
- DC solenoids Polarity insensitive with surge suppression
- Plug together circuit boards eliminate internal wiring
- Integral recessed gaskets
- IN Fittings to accommodate various tube sizes
- Simple conversion from internal to external pilot
- G3 Fieldbus Electronics
- IP65 Certified

Sandwich and Manifold Accessories

- Pressure Regulators for supply pressure control at individual valve
- Speed control to control exhaust flow allows for control of actuator extend or retract speed
- Shut off block for individual valve to be isolated from pressure supply during operation and repair
- Mid Station Supply Manifold block allows for multiple pressure zones (with blocking discs) or additional air supply to a manifold

Fieldbus Electronics Compatible

- G3 Fieldbus Electronics
 - Graphic Display for easy commissioning, visual status & diagnostics
 - 80 valve solenoids per manifold
 - Easy distribution of additional manifolds through Sub-Bus communication
 - One Node supports up to 16 I/O modules
 - Available with Auto Recovery Module (ARM) which allows configuration information to be saved and reloaded to replacement module automatically
- 580 Fieldbus Electronics
 - Graphic Display for easy commissioning, visual status & diagnostics
 - 80 valve solenoids per manifold

Construction

Materials in Contact w/Fluid	
Body	Aluminum, E-Coating treatment
Spool	Aluminum or Stainless Steel
Piston	POM
Spring	Steel
Spool Seals	NBR + PUR
Other Seals	NBR + FKM
Other materials	PAM (Polyarylamide) 50% Glass Fiber Reinforced
Valve to Subbase Gasket	NBR
Subbases	Aluminum, E-Coating treatment







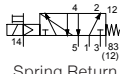

503 PERFORMANCE
& HOW TO ORDER

Operating Data

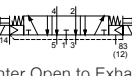
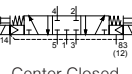
All Solenoids Are Continuous Duty Rated	24 VDC
Power (Watts)	1.7
Holding Current (Amps)	0.071
Ambient Temperature Range Min/Max °F (°C)	-14° F (-10° C)/122° F (50° C)

Performance Data

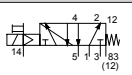
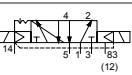
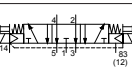
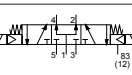
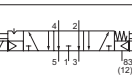
Function Type	Function Code	ISO Symbol Pilot (14) Return (12)	Interface	Rated Flow		Response Time (ms)	Pilot Pressure at 73°F/23°C PSI (bar)		Operating Pressure Port 1 PSI (bar)/inHg (-bar)		 Part Number
				at 90 PSI Cv (l/min (ANR))			min.	max	min.	max	
				1 → 2 1 → 4	2 → 3 4 → 5	Energize/ De-Energize					
Rubber Packed Technology, with Manual Override											
5/2	B1	 Spring Return	Proprietary	1.422 (1400)	1.321 (1300)	20/60	29 (2)	115 (8)	28 (-0.95)	115 (8)	R503A2B10MA00F1
			ISO	1.220 (1200)	1.118 (1100)						
	BN	 Differential Air Return	Proprietary	1.422 (1400)	1.321 (1300)	28/40	44 (3)	115 (8)	28 (-0.95)	115 (8)	R503A2BN0MA00F1
			ISO	1.220 (1200)	1.118 (1100)						
	B4	 Solenoid Air Return	Proprietary	1.422 (1400)	1.321 (1300)	20/20	29 (2)	115 (8)	28 (-0.95)	115 (8)	R503A2B40MA00F1
			ISO	1.220 (1200)	1.118 (1100)						
5/3	B5	 Center Open to Exhaust	Proprietary	0.610 (600)	1.321 (1300)	18/45	44 (3)	115 (8)	28 (-0.95)	115 (8)	R503A2B50MA00F1
			ISO	0.610 (600)	1.118 (1100)						
	B6	 Center Closed	Proprietary	1.422 (1400)	1.321 (1300)	15/20	58 (4)	115 (8)	28 (-0.95)	115 (8)	R503A2B60MA00F1
			ISO	1.220 (1200)	1.118 (1100)						
	B7	 Center Open to Pressure	Proprietary	1.321 (1300)	0.610 (600)	18/45	44 (3)	115 (8)	28 (-0.95)	115 (8)	R503A2B70MA00F1
			ISO	1.118 (1100)	0.610 (600)						
2 x 3/2 NO	BA	 Normally Open	Proprietary	0.965 (950)	0.965 (950)	15/20	51 (3.5)	115 (8)	51* (3.5)	115 (8)	R503A2BA0MA00F1
			ISO	0.915 (900)	0.915 (900)						
2 x 3/2 NC	BD	 Normally Closed	Proprietary	1.016 (1000)	0.813 (800)	15/20	51 (3.5)	115 (8)	51* (3.5)	115 (8)	R503A2BD0MA00F1
			ISO	0.915 (900)	0.813 (800)						
Spool and Sleeve Technology, with Manual Override											
5/2	B1	 Spring Return	Proprietary	1.220 (1200)	1.220 (1200)	20/60	29 (2)	115 (8)	28 (-0.95)	115 (8)	R503A1B10MA00F1
			ISO	1.118 (1100)	1.016 (1000)						
	B4	 Solenoid Air Return	Proprietary	1.220 (1200)	1.220 (1200)	15/15	29 (2)	115 (8)	28 (-0.95)	115 (8)	R503A1B40MA00F1
			ISO	1.118 (1100)	1.016 (1000)						
5/3	B5	 Center Open to Exhaust	Proprietary	1.016 (1000)	1.016 (1000)	20/60	29 (2)	115 (8)	28 (-0.95)	115 (8)	R503A1B50MA00F1
			ISO	0.813 (800)	0.813 (800)						
	B7	 Center Open to Pressure	Proprietary	1.016 (1000)	1.016 (1000)	20/60	29 (2)	115 (8)	28 (-0.95)	115 (8)	R503A1B70MA00F1
			ISO	0.813 (800)	0.813 (800)						
	BT	 Open Center, Spring and Detent	Proprietary	1.016 (1000)	1.016 (1000)	Spring: 20/60 Detent: 15/NA	29 (2)	115 (8)	28 (-0.95)	115 (8)	R503A1BT0MA00F1
			ISO	0.813 (800)	0.813 (800)						

* 51 PSI for a pressure supply (P1) ≤ 109 PSI (if > 109 PSI, Pmin. = P1-58 PSI)

How to Order: Valve

R 503 A 2 B 4 0 M A00 F1

Product Series
503 = 26mm Valve

Revision
A = Initial Release

Valve Type
1 = Spool and Sleeve
2 = Rubber Packed

Actuation
B = Solenoid Pilot w/ Flush Non-Locking Override

Function
1 = 2 Position 4-Way (5/2), Spring Return
4 = 2 Position 4-Way (5/2), Dual Solenoid
5 = 3 Position 4-Way (5/3), Open Center, Dual Pressure
6 = 3 Position 4-Way (5/3), Blocked Center
7 = 3 Position 4-way (5/3), Open to 4 & 2 in Center
A = Dual 3-way (2 x 3/2), 14 Normally Open - 12 Normally Open
D = Dual 3-way (2 x 3/2), 14 Normally Closed - 12 Normally Closed
N = 2 Position 4-Way (5/2), Differential Air Return w/o Spring
S = 5/3 Open Center, Spring and Detent

Voltage
F1 = 24 VDC

Options
A00 = Standard (No Options)
11B = Flush Locking Manual Override
11M = Without Manual Override

Electrical
M = Plug-in, w/ Light, VDC
2 N = M12 Connector
Pin 1 = Not Used; Pin 2 = Coil 12;
Pin 3 = Common; Pin 4 = Coil 14

Port Size
0 = No Port Size

1 Available with Functions 1, 4, 5 & 7
2 See diagram:

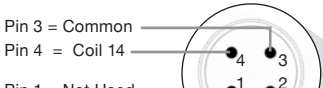

Regulator

R 503 A R S 1 1 J A00 1 0

Product Series
503 = 26mm Valve

Revision
A = Initial Release

Product Type
R = Regulator

Regulator Type
S = Single Reg. - Pressure to Port 1
D = Double Reg. - Pressure to Ports 5 & 3
* E = Double Reg. - Pressure to Ports 4 & 2, w/o Valve
T = Double Reg. - Pressure to Ports 1 & 3, 2 Pressure Selector

Pressure Range
1 = 10 - 130 PSIG (0.7 - 9 bar)
3 = 3 - 30 PSIG (0.2 - 2 bar)
4 = 5 - 60 PSIG (0.3 - 4.1 Plug-in)

Interface
* 0 = No Valve Interface
1 = Proprietary
2 = ISO 15407-2
3 = ISO 15407-1

Options
A00 = Standard (No Options)
16N = Jumper for Supply Pressure to Valve, 14 End
16P = Jumper for Supply Pressure to Valve, 12 End
14M = Tamperproof Needle Cartridge Assembly or Regulator

Wiring Option
J = Plug-in, Receptacle Assembly
* 0 = Non Plug-in

Gauge Type
1 = PSI
2 = bar
8 = with 1/8" NPTF adaptor for external gauge
G = with 1/8" G tap adaptor for external gauge

* For Regulator Type E must select 0 Wiring Option and 0 Interface

2002-R2 & O2 Series Functions

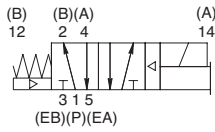

double solenoid air pilot
3 position 4-way
open center

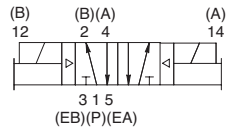

double solenoid air pilot
3 position 4-way
closed center

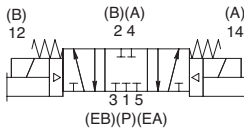
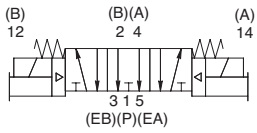

2002-R2 Series Only Functions

double solenoid
air pilot
dual 3-way
"12(B)" & "14(A)" NO

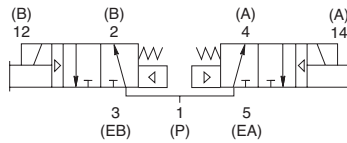

double solenoid
air pilot
dual 3-way
"12(B)" & "14(A)" NC

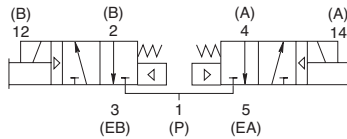

double solenoid
air pilot
2 position dual 3-way
"12(B)" NO, "14(A)" NC

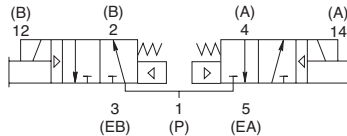

5 Ported, 2 and 3 position, 4-way and dual 3-way,
Packed Spool
Cv: 0.25 (4-way)

0.25 (Dual 3-way) R2 Series
Spool and Sleeve
Cv: 0.20 (4-way) O2 Series

- Solenoid air pilot actuated
- Low wattage coil
- Elimination of internal wiring
- Buna-N seals provide leakproof sealing
- Pusher piston-high spool shifting force
- Adjustable port sizes utilizing interchangeable cartridge fittings



Technical Data

Valve Data	English		Metric	
	R2 Series	O2 Series	R2 Series	O2 Series
Cv	0.25	0.2	0.25	0.2
Flow Capacity	11.5 SCFM @ 80 PSIG upstream pressure to atmosphere	9.2 SCFM @ 80 PSIG upstream pressure to atmosphere	246 NI/m @ 6 bar upstream pressure to 5 bar downstream	197 NI/m @ 6 bar upstream pressure to 5 bar downstream
Operating Pressure Range	28" Hg to 100 PSIG	28" Hg to 150 PSIG	Vacuum to 7 bar	Vacuum to 10 bar
Pilot Pressure Range	35 to 100 PSIG	35 to 100 PSIG	2.5 to 7 bar	2.5 to 7 bar
Temperature Range (Ambient)	-10 °F to 115 °F	-10 °F to 115 °F	-23 °C to 50 °C	-23 °C to 50 °C

Operating Data

All Solenoids are Continuous Duty Rated		24 VDC
Power (Watts)		0.5
Holding Current (Amps)		0.02

Response Time in Seconds	Energize		De-Energize	
	R2 Series	O2 Series	R2 Series	O2 Series
2-Position, Single, Spring Return	0.017	0.014	0.013	0.20
2-Position, Double, Detented	0.010	0.010	N/A	N/A
3-Position, Spring Centered	0.009	0.009	0.022	0.057
Dual 3-way	0.018	N/A	0.010	N/A

How To Order: Valves

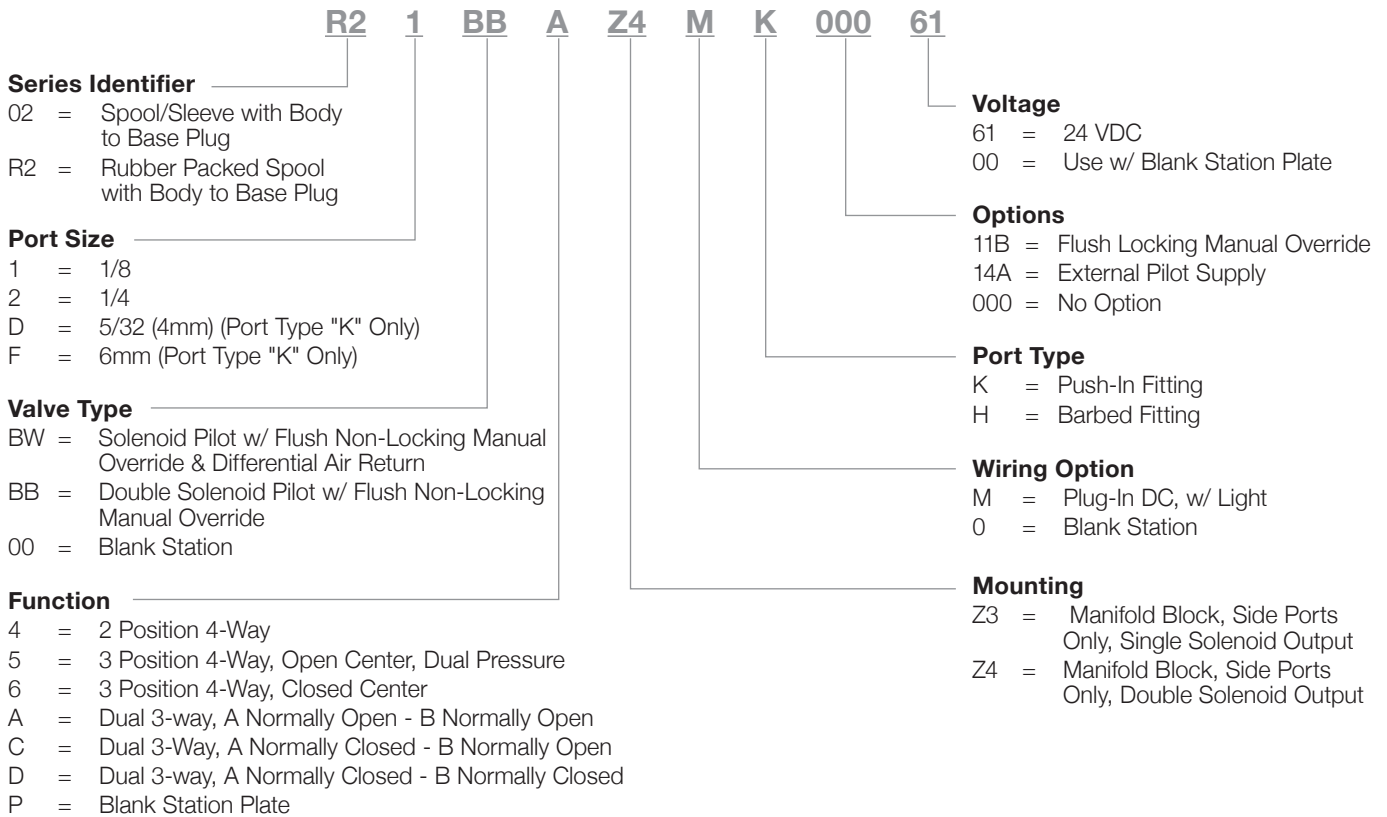

single solenoid air pilot
2 position 4-way

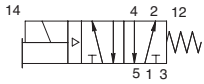

double solenoid air pilot
2 position 4-way

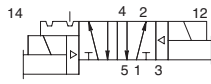

double solenoid air pilot
3 position 4-way
open center

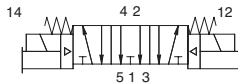

double solenoid air pilot
3 position 4-way
closed center

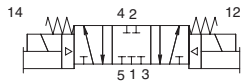

double solenoid air pilot
3 position 4-way
pressure center

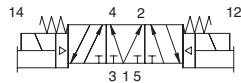

double solenoid
2 position dual 3-way
"14(A)" & "12(B)" NO

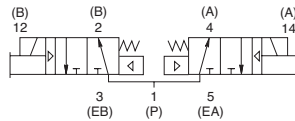

double solenoid
2 position dual 3-way
"14(A)" & "12(B)" NC

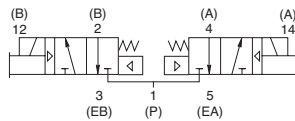

double solenoid
2 position dual 3-way
"14(A)" NC, "12(B)" NO

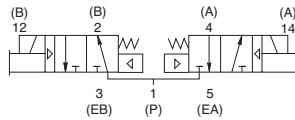

5 Ported, 2 and 3 position, 4-way, Spool & Sleeve
Cv: 0.56

Dual 3-Way Pack Spool
Cv: 0.56

- Solenoid air pilot actuated
- Low wattage coil
- DC solenoids polarity insensitive with spike suppression
- Plug together circuit boards eliminate internal wiring
- Integral recessed gaskets
- Interchangeable Push-In fittings to accommodate various tube sizes
- Simple conversion from internal to external pilot supply
- NEMA 4/IP65



Technical Data

Valve Data	English	Metric
Cv	0.56	0.56
Flow Capacity	26 SCFM @ 80 PSIG upstream pressure to atmosphere	552 NI/m @ 6 bar upstream to 5 bar downstream
Operating Pressure Range	28" Hg Vacuum to 150 PSIG	Vacuum to 10 bar
Operating Pressure Range – 3 Way	22" Hg Vacuum to 100 PSIG	Vacuum to 7 bar
Pilot Pressure Range	26 to 120 PSIG	1.8 to 8.2 bar
Pilot Pressure Range – 3 Way	26 to 100 PSIG	1.8 to 7 bar
Pilot Pressure Vacuum	50 to 100 PSIG	3.5 to 7 bar
Temperature Range (Ambient)	-10 °F to 115 °F	-23 °C to 50 °C

Operating Data

All Solenoids are Continuous Duty Rated	24 VDC
Power (Watts)	1.35
Holding Current (Amps)	0.056

Response Time in Seconds	Energize	De-Energize
2-Position, Single, Spring Return	0.014	0.016
2-Position, Double, Detented	0.013	N/A
3-Position, Spring Centered	0.014	0.016
Dual 3-way	0.014	0.016



How to Order: Valves

051 BB 4 Z6 M N 000 61

Valve Series & Port Size

- 051 = 1/8 (Threaded Only)
- 052 = 1/4 (Push-In Only)
- 05F = 6mm
- 05H = 8mm

Valve Type

- BA = Single Solenoid Pilot (Spring Return) w/ Flush Non-Locking Override
- BB = Double Solenoid Pilot w/ Flush Non-Locking Override
- 00 = Blank Station

Function

- 4 = 2 Position 4-Way
- 5 = 3 Position 4-Way, Open Center
- 6 = 3 Position 4-Way, Closed Center
- 7 = 3 Position, 4-Way Pressure Center
- A = Dual 3-Way, A Normally Open - B Normally Open
- B = Dual 3-Way, Vacuum Service, A Normally Open - B Normally Open
- D = Dual 3-way, A Normally Closed - B Normally Closed
- E = Dual 3-Way, Vacuum Service, A Normally Closed - B Normally Closed
- P = Blank Station Plate

Voltage

- 61 = 24 VDC
- 00 = Use w/ Blank Station Plate

Options

- 11B = Flush Locking Manual Override
- 11M = No Override
- 000 = No Option

Port Type

- L = Push-In Fitting
- N = NPTF (1/8 Only)
- G = G Tap (1/8 Only)

Wiring Option

- M = Plug-In DC, w/ Light
- 0 = Blank Station

Mounting

- Z1 = Manifold Block w/ Side and Bottom Ports, Single Solenoid Internal Circuit Board
- Z2 = Manifold Block w/ Side and Bottom Ports, Double Solenoid Internal Circuit Board
- Z5 = Z1 w/ Speed Control
- Z6 = Z2 w/ Speed Control
- R1 = Z1 w/ Ribbon Cable Connector
- R2 = Z2 w/ Ribbon Cable Connector
- R5 = Z5 w/ Ribbon Cable Connector
- R6 = Z6 w/ Ribbon Cable Connector

Regulators

051 RS 1 Z1 J K 000 00

Valve Series & Port Size

- 051 = 1/8
- 052 = 1/4 (Push-In Only)
- 05F = 6mm
- 05H = 8mm
- * Use for Regulator Unit Only (Mounting = 00)

Regulator Type

- RS = Single Pressure to Port 1 (P)
- RD = Dual Pressure to Ports 3 (EB) & 5 (EA)
- RE = Dual Pressure to Ports 4 (4) & 2 (B)
- RT = 2 Pressure Selector
- * For Metric Gauge replace R with E in 4th digit

Pressure Range

- 1 = 10 – 130 PSIG (0.7 – 9 bar)
- 3 = 3 – 30 PSIG (0.2 – 2 bar)
- 4 = 5 – 60 PSIG (0.5 – 4 bar)

Mounting

- Z0 = Manifold Block w/ Side and Bottom Ports, Transfer board, used w/ RE Regulators
- Z1 = Manifold Block w/ Side and Bottom Ports, Single Solenoid Internal Circuit Board
- Z2 = Manifold Block w/ Side and Bottom Ports, Double Solenoid Internal Circuit Board
- Z5 = Z1 w/ Speed Control
- Z6 = Z2 w/ Speed Control
- R1 = Z1 w/ Ribbon Cable Connector
- R2 = Z2 w/ Ribbon Cable Connector
- R5 = Z5 w/ Ribbon Cable Connector
- R6 = Z6 w/ Ribbon Cable Connector

Options

- 12H = Less Gauge
- 16N = Jumper on 14 (A) End
- 16P = Jumper on 12 (B) End
- 16W = Top Facing Gauge
- 61Y = Extended Gauge
- 63D = 16W + 61Y Extended Top Facing Gauge
- 000 = No Option

Port Type

- K = Push-In
- P = NPTF (1/8 Only)
- Q = G Tap (1/8 Only)

Wiring Option

- J = Plug-In Receptacle Assembly

See NOTE Below



NOTE: Regulator Gauges must be offset on alternating stations to prevent interference (see photo)
 Odd numbered stations will use either standard (no option) or top facing ("16W" option) gauges
 Even numbered stations will use either extended standard ("61Y" option) or extended top facing ("63D" option) gauges

single solenoid air pilot
2 position 4-way

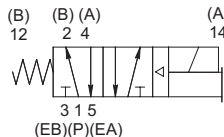

double solenoid air pilot
2 position 4-way

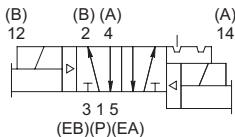

double solenoid air pilot
3 position 4-way
open center

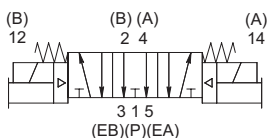

double solenoid air pilot
3 position 4-way
closed center

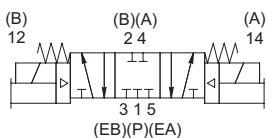

double solenoid air pilot
3 position 4-way
pressure center

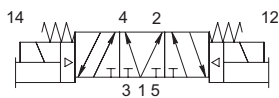

5 Ported, 2 and 3 position, 4-way, Spool & Sleeve
Cv: 1.2

- Solenoid air pilot actuated
- Low wattage coil
- DC solenoids polarity insensitive with spike suppression
- Plug together circuit boards eliminate internal wiring
- Integral recessed gaskets
- Interchangeable Push-In fittings to accommodate various tube sizes
- Simple conversion from internal to external pilot
- NEMA 4/IP65



Technical Data

Valve Data	English	Metric
Cv	1.20	1.20
Flow Capacity	56 SCFM @ 80 PSIG upstream pressure to atmosphere	1180 NI/m @ 6 bar upstream to 5 bar downstream
Operating Pressure Range	28" Hg Vacuum to 150 PSIG	Vacuum to 10 bar
Pilot Pressure Range	26 to 120 PSIG	1.8 to 8.2 bar
Temperature Range (Ambient)	-10 °F to 115 °F	-23 °C to 50 °C

Operating Data

All Solenoids are Continuous Duty Rated	24 VDC
Power (Watts)	2.5
Holding Current (Amps)	0.10

Response Time in Seconds	Energize	De-Energize
2-Position, Single, Spring Return	0.010	0.020
2-Position, Double, Detented	0.010	N/A
3-Position, Spring Centered	0.010	0.020

How to Order

Valves

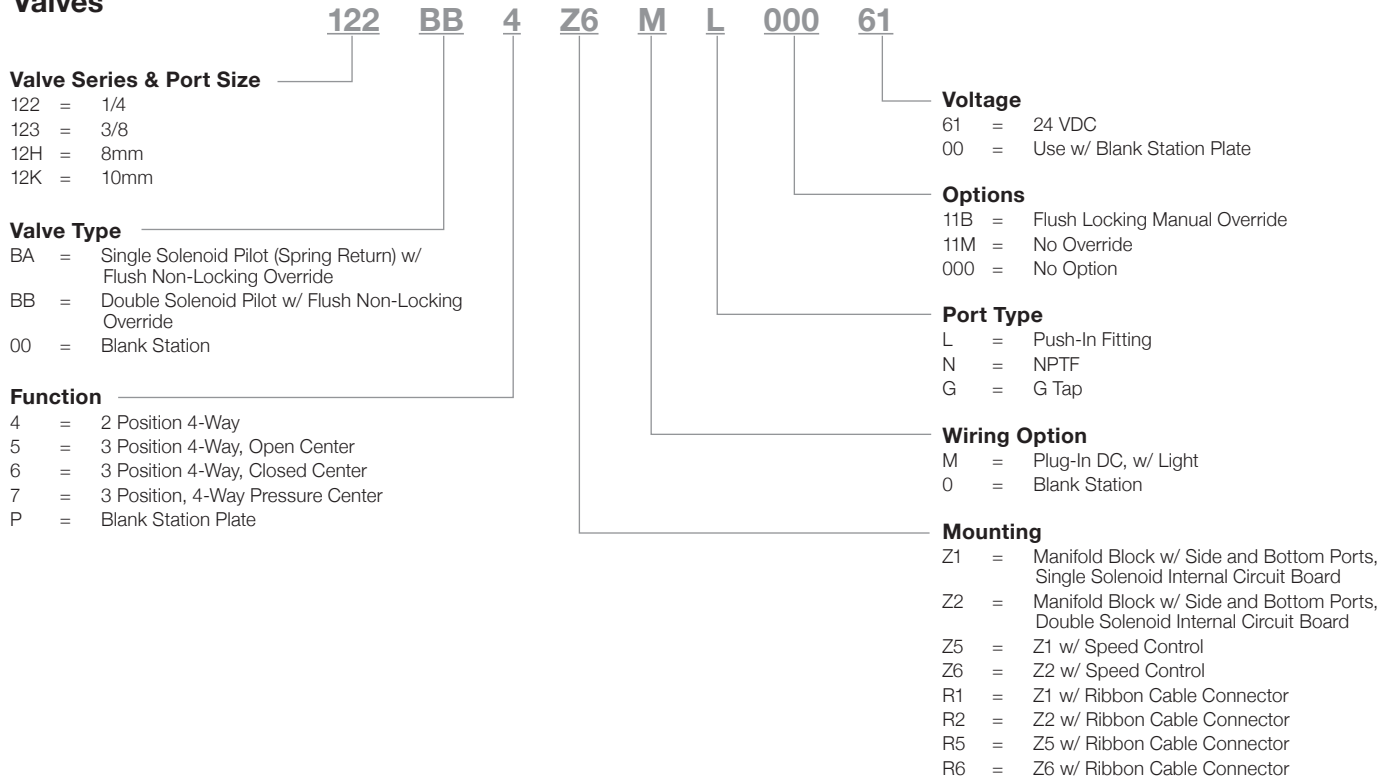

Regulators

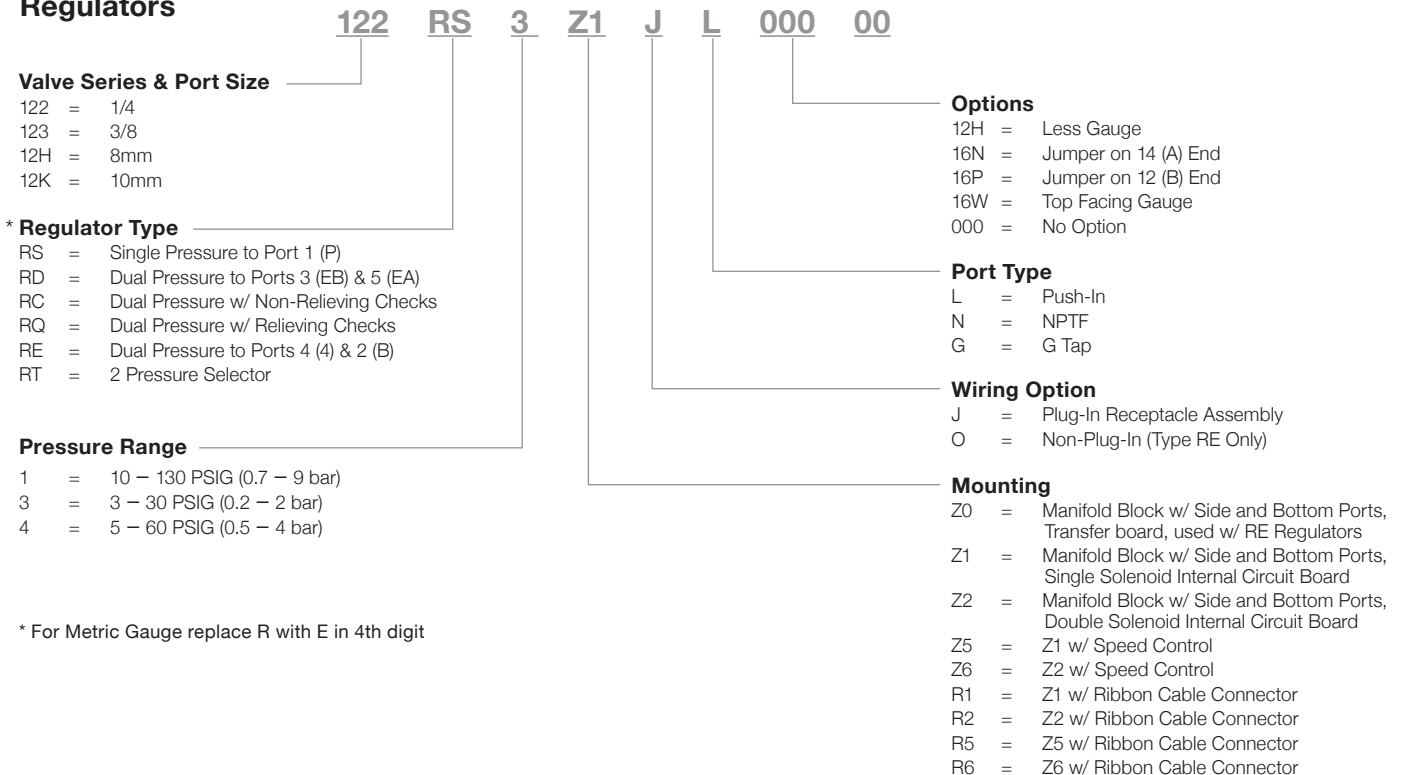

* For Metric Gauge replace R with E in 4th digit

single solenoid air pilot
2 position 4-way

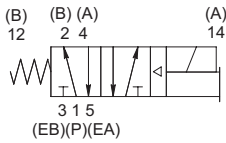

double solenoid air pilot
2 position 4-way

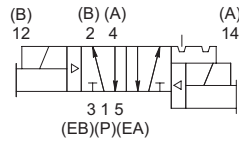

double solenoid air pilot
3 position 4-way
open center

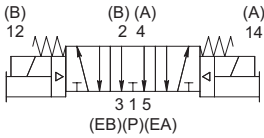

double solenoid air pilot
3 position 4-way
closed center

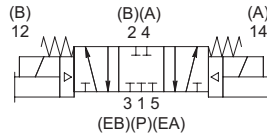

5 Ported, 2 and 3 position, 4-way, Spool & Sleeve
Cv: 3.5

- Solenoid air pilot actuated
- Low wattage coil
- DC solenoids polarity insensitive with spike suppression
- Plug together circuit boards eliminate internal wiring
- Integral recessed gaskets
- Simple conversion from internal to external pilot supply
- Designed to meet NEMA 4/IP65
- Manifold connection allows disassembly at any station



Technical Data

Valve Data	English	Metric
Cv	3.5*	3.5*
Flow Capacity	161 SCFM @ 80 PSIG upstream pressure to atmosphere	3500 NI/m @ 6 bar upstream pressure to 5 bar atmosphere
Operating Pressure Range	28" Hg Vacuum to 145 PSIG	Vacuum to 10 bar
Pilot Pressure Range	26.1 to 120 PSIG	1.8 to 8.2 bar
Temperature Range (Ambient)	-10 °F to 115 °F	-23 °C to 50 °C

* Valve on 1/2 NPTF Sub-Plate

Operating Data

All Solenoids are Continuous Duty Rated	24 VDC
Power (Watts)	2.5
Holding Current (Amps)	0.10

Response Time in Seconds**	Energize	De-Energize
2-Position, Single, Spring Return	0.021	0.067
2-Position, Double, Detented	0.017	N/A
3-Position, Spring Centered	0.021	0.072

** Per ISO 12238 Standard

How to Order: Valves

353 BB 4 Z6 M N 000 61

Valve Series & Port Size
 353 = 3/8
 354 = 1/2

Valve Type
 BA = Single Solenoid Pilot (Spring Return) w/ Flush Non-Locking Override
 BB = Double Solenoid Pilot w/ Flush Non-Locking Override
 00 = Blank Station

Function
 4 = 2 Position 4-Way
 5 = 3 Position 4-Way, Open Center
 6 = 3 Position 4-Way, Closed Center
 P = Blank Station Plate

Voltage
 61 = 24 VDC
 00 = Use w/ Blank Station Plate

Options
 11B = Flush Locking Manual Override
 11M = No Override
 000 = No Option

Port Type
 N = NPTF
 G = G Tap

Wiring Option
 M = Plug-In DC, w/ Light
 0 = Blank Station

Mounting
 Z1 = Manifold Block w/ Side and Bottom Ports, Single Solenoid Internal Circuit Board
 Z2 = Manifold Block w/ Side and Bottom Ports, Double Solenoid Internal Circuit Board
 Z5 = Z1 w/ Speed Control
 Z6 = Z2 w/ Speed Control
 R1 = Z1 w/ Ribbon Cable Connector
 R2 = Z2 w/ Ribbon Cable Connector
 R5 = Z5 w/ Ribbon Cable Connector
 R6 = Z6 w/ Ribbon Cable Connector

Regulators

353 RS 3 Z1 J N 000 00

Valve Series & Port Size
 353 = 3/8
 354 = 1/2

Regulator Type
 RS = Single Pressure to Port 1 (P)
 RD = Dual Pressure to Ports 3 (EB) & 5 (EA)
 RC = Dual Pressure w/ Non-Relieving Checks
 RQ = Dual Pressure w/ Relieving Checks
 RE = Dual Pressure to Ports 4 (A) & 2 (B)
 RT = 2 Pressure Selector
 * For Metric Gauge replace R with E in 4th digit

Pressure Range
 1 = 10 – 130 PSIG (0.7 – 9 bar)
 3 = 3 – 30 PSIG (0.2 – 2 bar)
 4 = 5 – 60 PSIG (0.5 – 4 bar)

Options
 12H = Less Gauge
 16N = Jumper on 14 (A) End
 16P = Jumper on 12 (B) End
 16W = Top Facing Gauge
 000 = No Option

Port Type
 N = NPTF
 G = G Tap

Wiring Option
 J = Plug-In Receptacle Assembly
 O = Non-Plug-In (Type RE Only)

Mounting
 Z0 = Manifold Block w/ Side and Bottom Ports, Transfer board, used w/ RE Regulators
 Z1 = Manifold Block w/ Side and Bottom Ports, Single Solenoid Internal Circuit Board
 Z2 = Manifold Block w/ Side and Bottom Ports, Double Solenoid Internal Circuit Board
 Z5 = Z1 w/ Speed Control
 Z6 = Z2 w/ Speed Control
 R1 = Z1 w/ Ribbon Cable Connector
 R2 = Z2 w/ Ribbon Cable Connector
 R5 = Z5 w/ Rib on Cable Connector
 R6 = Z6 w/ Ribbon Cable Connector

single solenoid air pilot
2 position 4-way

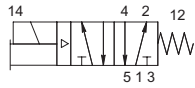

double solenoid air pilot
2 position 4-way

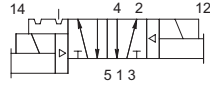

double solenoid air pilot 3 position
4-way open center

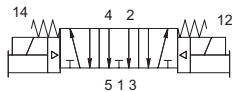

double solenoid air pilot 3 position
4-way closed center

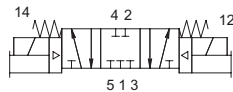

5 Ported, 2 and 3 position, 4-way, Spool & Sleeve
Cv: 0.56

- Solenoid air pilot actuated
- Low wattage coil
- DC solenoids polarity insensitive with spike suppression
- Plug together circuit boards eliminate internal wiring
- Integral recessed gaskets
- Interchangeable Push-In fittings to accommodate various tube sizes
- Simple conversion from internal to external pilot
- NEMA 4/IP65



Technical Data - 18mm

Valve Data	English	Metric
Cv	0.56	0.56
Flow Capacity	26 SCFM @ 80 PSIG upstream pressure to atmosphere	552 NI/m @ 6 bar upstream to 5 bar downstream
Operating Pressure Range	28" Hg Vacuum to 150 PSIG	Vacuum to 10 bar
Pilot Pressure Range	26 to 120 PSIG	1.8 to 8.2 bar
Temperature Range (Ambient)	-10 °F to 115 °F	-23 °C to 50 °C

Operating Data

All Solenoids are Continuous Duty Rated	24 VDC
Power (Watts)	1.35
Holding Current (Amps)	0.056

Response Time in Seconds	Energize	De-Energize
2-Position, Single, Spring Return	0.014	0.016
2-Position, Double, Detented	0.013	N/A
3-Position, Spring Centered	0.014	0.016

How to Order 15407-2 18mm: Valves

I51 BB 4 Z6 M N 000 61

Valve Series & Port Size

- I51 = 1/8 (Threaded Only)
- I52 = 1/4 (Push-In Only)
- I5F = 6mm
- I5H = 8mm

Valve Type

- BA = Single Solenoid Pilot (Spring Return) w/ Flush Non-Locking Override
- BB = Double Solenoid Pilot w/ Flush Non-Locking Override
- 00 = Blank Station

Function

- 4 = 2 Position 4-Way
- 5 = 3 Position 4-Way, Open Center
- 6 = 3 Position 4-Way, Closed Center
- P = Blank Station Plate

Voltage

- 61 = 24 VDC
- 00 = Use w/ Blank Station Plate

Options

- 11B = Flush Locking Manual Override
- 11M = No Override
- 000 = No Option

Port Type

- L = Push-In Fitting
- N = NPTF (1/8 Only) or Valve Unit Only
- G = G Tap (1/8 Only) ISO 228/1-G

Wiring Option

- M = Plug-In DC, w/ Light
- 0 = Blank Station

Mounting

- Z1 = Manifold Block w/ Side and Bottom Ports, Single Solenoid Internal Circuit Board
- Z2 = Manifold Block w/ Side and Bottom Ports, Double Solenoid Internal Circuit Board
- Z5 = Z1 w/ Speed Control
- Z6 = Z2 w/ Speed Control
- R1 = Z1 w/ Ribbon Cable Connector
- R2 = Z2 w/ Ribbon Cable Connector
- R5 = Z5 w/ Ribbon Cable Connector
- R6 = Z6 w/ Ribbon Cable Connector

Regulators

I51 RS 1 Z1 J K 000 00

Valve Series & Port Size

- I51 = 1/8
- I52 = 1/4 (Push-In Only)
- I5F = 6mm
- I5H = 8mm

Regulator Type

- RS = Single Pressure to Port 1 (P)
- RD = Dual Pressure to Ports 3 (EB) & 5 (EA)
- RE = Dual Pressure to Ports 4 (A) & 2 (B)
- RT = 2 Pressure Selector

Pressure Range

- 1 = 10 – 130 PSIG (0.7 – 9 bar)
- 3 = 3 – 30 PSIG (0.2 – 2 bar)
- 4 = 5 – 60 PSIG (0.5 – 4 bar)

Mounting

- Z1 = Manifold Block w/ Side and Bottom Ports, Single Solenoid Internal Circuit Board
- Z2 = Manifold Block w/ Side and Bottom Ports, Double Solenoid Internal Circuit Board
- Z5 = Z1 w/ Speed Control
- Z6 = Z2 w/ Speed Control
- R1 = Z1 w/ Ribbon Cable Connector
- R2 = Z2 w/ Ribbon Cable Connector
- R5 = Z5 w/ Ribbon Cable Connector
- R6 = Z6 w/ Ribbon Cable Connector

Options

- 12H = Less Gauge
- 16N = Jumper on 14 (A) End
- 16P = Jumper on 12 (B) End
- 16W = Top Facing Gauge
- 61Y = Extended Gauge
- 63D = 16W + 61Y Extended Top Facing Gauge
- 000 = No Option

Port Type

- L = Push-In
- N = NPTF (1/8 Only)
- G = G Tap (1/8 Only) ISO 228/1-G

Wiring Option

- J = Plug-In Receptacle Assembly

See NOTE Below



NOTE: Regulator Gauges must be offset on alternating stations to prevent interference (see photo)
 Odd numbered stations will use either standard (no option) or top facing ("16W" option) gauges
 Even numbered stations will use either extended standard ("61Y" option) or extended top facing ("63D" option) gauges

single solenoid air pilot
2 position 4-way

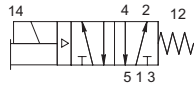

double solenoid air pilot
2 position 4-way

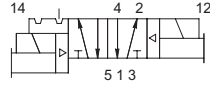

double solenoid air pilot 3 position
4-way open center

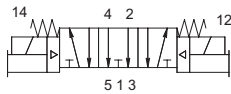

double solenoid air pilot 3 position
4-way closed center

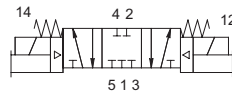

5 Ported, 2 and 3 position, 4-way, Spool & Sleeve
Cv: 1.2

- Solenoid air pilot actuated
- Low wattage coil
- DC solenoids polarity insensitive with spike suppression
- Plug together circuit boards eliminate internal wiring
- Integral recessed gaskets
- Interchangeable Push-In fittings to accommodate various tube sizes
- Simple conversion from internal to external pilot
- Modular plug-together Fieldbus electronics
- NEMA 4/IP65



Technical Data - 26mm

Valve Data	English	Metric
Cv	1.20	1.20
Flow Capacity	56 SCFM @ 80 PSIG upstream pressure to atmosphere	1180 NI/m @ 6 bar upstream to 5 bar downstream
Operating Pressure Range	28" Hg Vacuum to 150 PSIG	Vacuum to 10 bar
Pilot Pressure Range	26 to 120 PSIG	1.8 to 8.2 bar
Temperature Range (Ambient)	-10 °F to 115 °F	-23 °C to 50 °C

Operating Data

All Solenoids are Continuous Duty Rated	24 VDC
Power (Watts)	2.5
Holding Current (Amps)	0.10

Response Time in Seconds	Energize	De-Energize
2-Position, Single, Spring Return	0.010	0.020
2-Position, Double, Detented	0.010	N/A
3-Position, Spring Centered	0.010	0.020

How to Order 15407-2 26mm: Valves

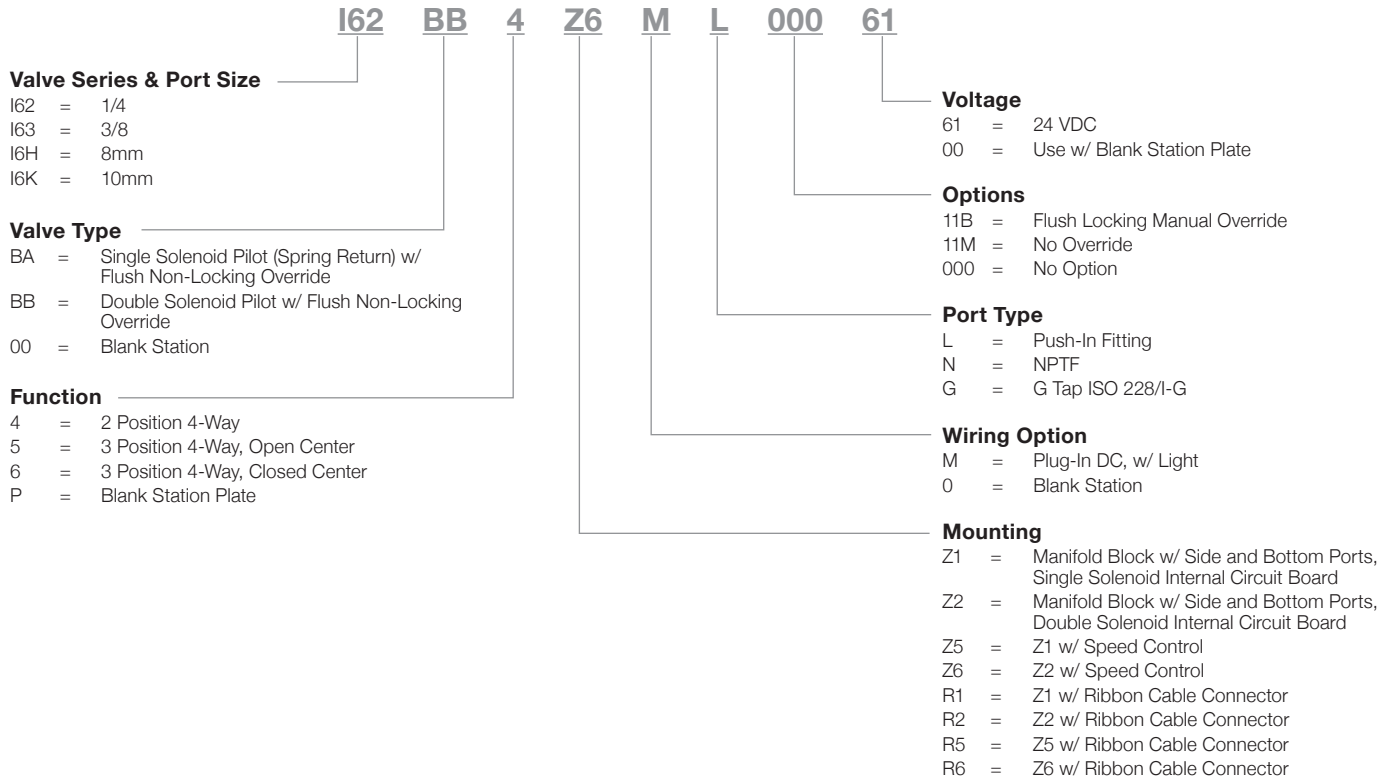

Regulators

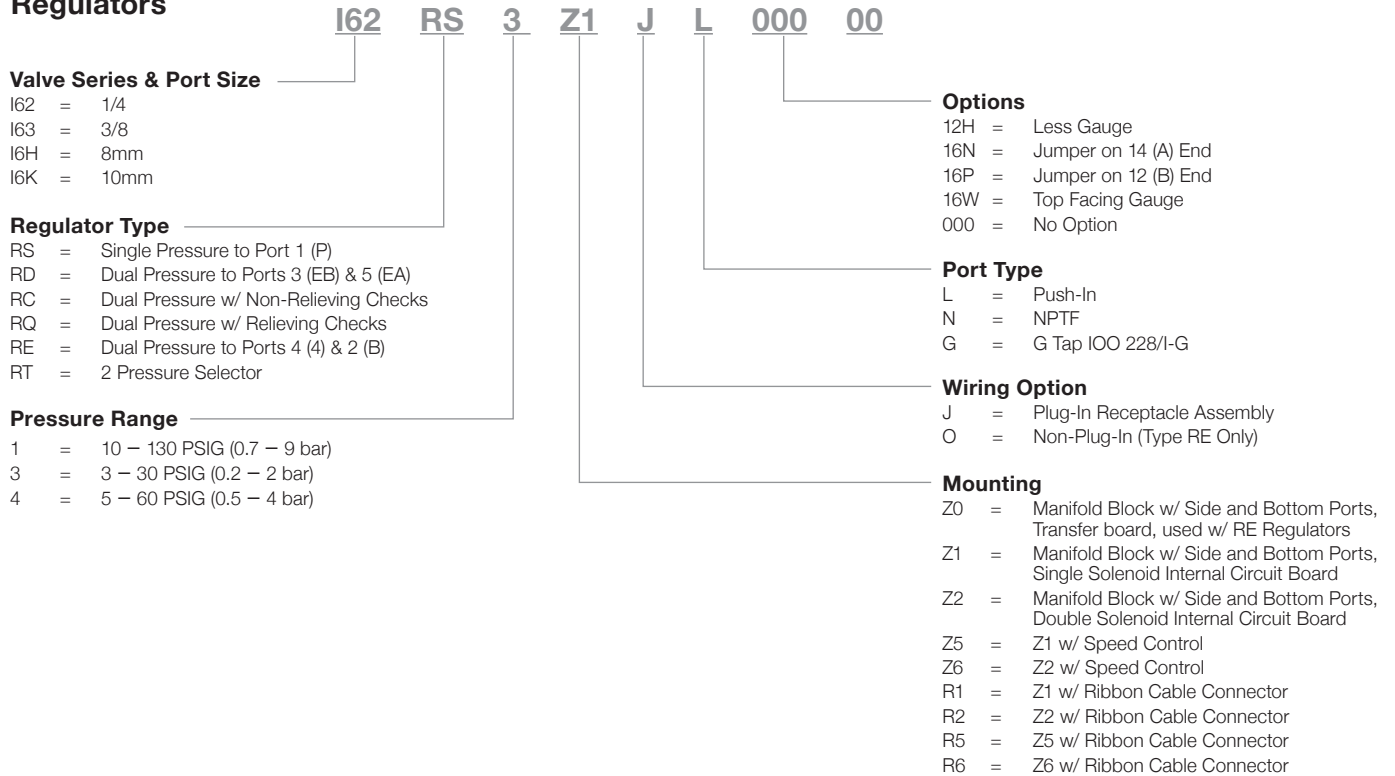

Direct Solenoid Actuated

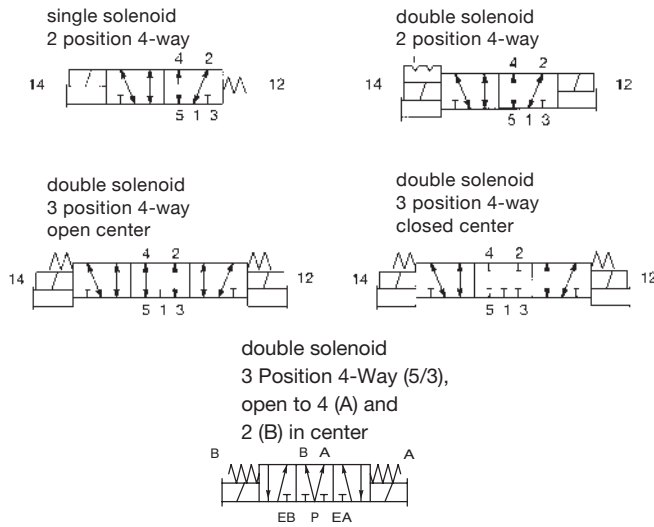

Solenoid Pilot Actuated

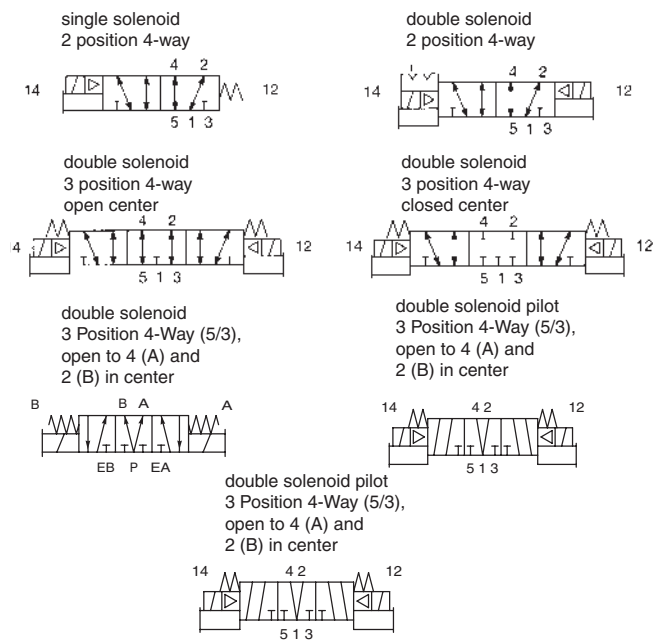

5 Ported, 4-way, 2 and 3 position, Spool & Sleeve,
Cv: 1.2 to 5.3

- Direct and Solenoid Pilot Actuated
- Complies with ISO Standard 5599/2- Sizes 1, 2 & 3
- NEMA 4/IP65



Technical Data

Valve Data		Direct Acting		Solenoid Pilot Actuated	
		English	Metric	English	Metric
Cv	Size 1 Size 2 Size 3	1.2 2 NA	1.2 2 NA	1.3 2.9 5.3	1.3 2.9 5.3
Flow Capacity	Size 1 Size 2 Size 3	55.5 SCFM 101.7 SCFM NA	1181 NI/m 2168 NI/m NA	60.1 SCFM 134.0 SCFM 245.0 SCFM	1280 NI/m 2857 NI/m 5222 NI/m
Main valve operating pressure range - All sizes		80 PSIG upstream pressure to atmosphere	6 bar upstream to 5 bar downstream	80 PSIG upstream pressure to atmosphere	6 bar upstream to 5 bar downstream
Pilot pressure range - All sizes		28" Hg to 232 PSIG	Vacuum to 16 bar	15 to 125 PSIG	1 to 8.6 bar
Temperature Range (Ambient) - All sizes		-10°F to 115°F	-23°C to 50°C	-10°F to 115°F	-23°C to 50°C

Operating Data - All solenoids continuous duty rated

All Solenoids are Continuous Duty Rated	24 VDC Direct Acting		24 VDC Solenoid Pilot	
	Sizes 1 & 2	Size 3	Size 1 & 2	Size 3
Power (Watts) - All Sizes	6.0	NA	4.0	4.0
Holding Current (Amps)	.25	NA	0.016	0.016
In-Rush Current (Amps) - All Sizes	NA	NA	NA	NA

Response Time in Seconds	Direct Acting				Solenoid Pilot Actuated					
	Energize (Sec)		De-Energize (Sec)		Energize (Sec)			De-Energize (Sec)		
	Sizes 1 & 2	Size 3	Sizes 1 & 2	Size 3	Size 1	Size 2	Size 3	Size 1	Size 2	Size 3
2-Position, Single, Spring Return	0.038	NA	0.012	NA	0.013	0.013	0.020	0.036	0.060	0.066
2-Position, Double, Detented	0.012	NA	NA	NA	0.013	0.013	0.020	NA	NA	NA
3-Position, Spring Centered	0.038	NA	NA	NA	0.013	0.013	0.020	0.036	0.060	0.066

How to Order: Valves

I24 BA 4 Z1 M P 000 61

Valve Series & Port Size

- I12 = ISO 5599/2 Size 1 1/4"
- I13 = ISO 5599/2 Size 1 3/8"
- I23 = ISO 5599/2 Size 2 3/8"
- I24 = ISO 5599/2 Size 2 1/2"
- * I34 = ISO 5599/2 Size 3 1/2"
- * I35 = ISO 5599/2 Size 3 3/4"

1st Letter = "14" Actuator

2nd Letter = "12" Actuator

- BA = Single Solenoid Pilot w/ Spring Return
- BB = Double Solenoid
- BW = Solenoid Pilot w/ Differential Air Return
- SA = Direct Solenoid w/ Spring Return
- SS = Double Direct Solenoid
- 00 = Blank Station

Function

- 4 = 2 Position 4-Way
- 5 = 3 Position 4-Way, Open Center
- 6 = 3 Position 4-Way, Closed Center
- 7 = 3 Position 4-Way (5/3), Open to 4 (A) and 2 (B) in Center
- P = Blank Station Plate

Mounting

- Z1 = Manifold Block w/ Side and Bottom Ports, Single Solenoid Internal Circuit Board
- Z2 = Manifold Block w/ Side and Bottom Ports, Double Solenoid Internal Circuit Board
- Z5 = Z1 w/ Speed Control
- Z6 = Z2 w/ Speed Control
- R1 = Z1 w/ Ribbon Cable Connector
- R2 = Z2 w/ Ribbon Cable Connector
- R5 = Z5 w/ Ribbon Cable Connector
- R6 = Z6 w/ Ribbon Cable Connector

Voltage

- 61 = 24 VDC
- 00 = Use w/ Blank Station Plate

Options

- 11B = Flush Locking Manual Override
- 11Z = Extended Locking Manual Override (Direct Acting Only)
- 12A = FKM Seals on Sleeve Assembly
- 12B = Lubricant Free Assembly
- 14C = Internal Pilot Supply from Port 3 (Solenoid Pilot Only)
- 14D = Internal Pilot Supply from Port 5 (Solenoid Pilot Only)
- 14X = External Pilot Supply
- 000 = No Option

Port Type

- 0 = NPTF (Direct Solenoid Valves)
- G = G Tap (Direct Solenoid Valves) (Conforms to ISO Standards 1179-1 and 228-1)
- P = NPTF (Solenoid Pilot Valves)
- Q = G Tap (Solenoid Pilot Valves) (Conforms to ISO Standards 1179-1 and 228-1)

Wiring Option

- M = Plug-In DC, w/ Light
- 0 = Blank Station

* Not available in Direct Operated SA and SS Series

NOTE: Standard for all ISO 5599/2 Solenoid Pilot Valve Series is internal pilot supply from Port 1

Regulators

I24 RS 1 Z1 J P 000 00

Valve Series & Port Size

- I12 = ISO 5599/2 Size 1 1/4"
- I13 = ISO 5599/2 Size 1 3/8"
- I23 = ISO 5599/2 Size 2 3/8"
- I24 = ISO 5599/2 Size 2 1/2"
- I34 = ISO 5599/2 Size 3 1/2"
- I35 = ISO 5599/2 Size 3 3/4"

Regulator Type

- RS = Single Pressure to Port 1 (P)
- * RD = Dual Pressure to Ports 3 (EB) & 5 (EA)
- * RC = Dual Pressure w/ Non-Relieving Checks Air Return (Sizes 2 & 3 Only)
- RQ* = Dual Pressure w/ Relieving Checks
- RE = Dual Pressure, External Outlet

Pressure Range

- 1 = 10 – 130 PSIG (0.7 – 9 bar)
- 3 = 3 – 30 PSIG (0.2 – 2 bar)
- 4 = 5 – 60 PSIG (0.5 – 4 bar)
- 6 = 20 – 250 PSIG (1.4 – 17 bar)

* Solenoid Pilot Valves used with RC, RD & RQ Regulators must have the pilot supply from other than internally from Port 1 (P)

Options

- 16N = Jumper on 14 (A) End
- 16P = Jumper on 12 (B) End
- 000 = No Option

Port Type

- P = NPTF
- Q = G Tap

Wiring Option

- J = Plug-In Receptacle Assembly
- O = Non-Plug-In (Type RE Only)

Mounting

- Z0 = Manifold Block w/ Side and Bottom Ports, Transfer board, used w/ RE Regulators
- Z1 = Manifold Block w/ Side and Bottom Ports, Single Solenoid Internal Circuit Board
- Z2 = Manifold Block w/ Side and Bottom Ports, Double Solenoid Internal Circuit Board
- Z5 = Z1 w/ Speed Control
- Z6 = Z2 w/ Speed Control
- R1 = Z1 w/ Ribbon Cable Connector
- R2 = Z2 w/ Ribbon Cable Connector
- R5 = Z5 w/ Ribbon Cable Connector
- R6 = Z6 w/ Ribbon Cable Connector

7/8" MINI Cables

4 Pin Cables for DeviceNet™, DeviceLogix™, EtherNet/IP™, EtherNet/IP™ DLR, Modbus® TCP/IP, CANopen®, and Sub-bus



7/8" MINI Straight 4 Pin Female Single Ended Cable, Euro Color Code

MC0405MAC00000000 – 5 Meter

MC0410MAC00000000 – 10 Meter



7/8" MINI 90° 4 Pin Female Single Ended Cable, Euro Color Code

MD0405MAC00000000 – 5 Meter

MD0410MAC00000000 – 10 Meter

5 Pin Cables for PROFIBUS™ DP, PROFINET™, POWERLINK®, EtherCAT®, and CC-Link IE Field™



7/8" MINI Straight 5 Pin Female Single Ended Cable, Euro Color Code

MC0505MAG00000000 – 5 Meter

MC0510MAG00000000 – 10 Meter



7/8" MINI 90° 5 Pin Female Single Ended Cable, Euro Color Code

MD0505MAG00000000 – 5 Meter

MD0510MAG00000000 – 10 Meter

7/8" MINI Field Wireable Connectors

4 Pin Connectors for DeviceNet™, DeviceLogix™, EtherNet/IP™, EtherNet/IP™ DLR, Modbus® TCP/IP, CANopen®, and Sub-bus



7/8" MINI Straight 4 Pin Female Field Wireable Connector

MC04F90000000000 – Cable Gland – One size fits all



7/8" MINI 90° 4 Pin Female Field Wireable Connector

MD04F20000000000 – PG 9 Cable Gland

5 Pin Connectors for PROFIBUS™ DP, PROFINET™, POWERLINK®, EtherCAT®, and CC-Link IE Field™



7/8" MINI Straight 5 Pin Female Field Wireable Connector

MC05F90000000000 – Cable Gland – One size fits all



7/8" MINI 90° 5 Pin Female Field Wireable Connector

MD05F20000000000 – PG 9 Cable Gland

M12 to 7/8" MINI Cable
4 Pin Cable for Sub-bus Power



M12 Straight 4 Pin Male to 7/8" MINI 4 Pin Female Extension
TA0401MA0MC0471T – 1 Meter
TA0405MA0MC0471T – 5 Meter
TA0410MA0MC0471T – 10 Meter

M12 Cables
4 Pin Cables for Sub-bus Power



M12 Straight 4 Pin Female Single Ended Cable, Euro Color Code
TC0405MAE0000000 – 5 Meter
TC0410MAE0000000 – 10 Meter



M12 90° 4 Pin Female Single Ended Cable, Euro Color Code
TD0405MAE0000000 – 5 Meter
TD0410MAE0000000 – 10 Meter



M12 Straight 4 Pin Male to Female Cable Extension
TC0401MAETA04000 – 1 Meter
TC0405MAETA04000 – 5 Meter
TC0410MAETA04000 – 10 Meter

M12 Field Wireable Connectors
4 Pin Connectors for Sub-bus Power



M12 Straight 4 Pin Female Field Wireable Connector
TC04F10000000000 – PG 7 Cable Gland
TC04F20000000000 – PG 9 Cable Gland



M12 90° 4 Pin Female Field Wireable Connector
TD04F10000000000 – PG 7 Cable Gland
TD04F20000000000 – PG 9 Cable Gland

Pin Out and Technical Data

M12 Cable - Pin Out/Euro Color Code

(Male View)

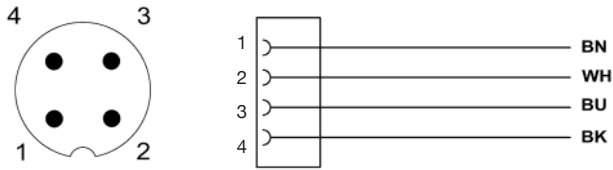

7/8" MINI Cable - Pin Out/Euro Color Code

(Male View)

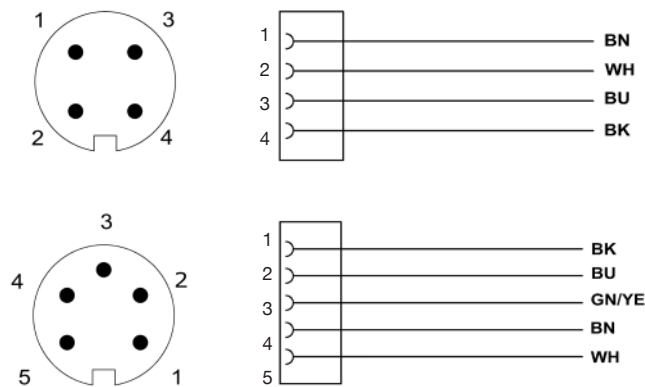

Technical Data	M12	7/8" MINI
Molded Body/Insert	Cable = PVC Field Wireable = Polyamide	Cable = PVC Field Wireable = Polyamide or PBT
Coupling Nut	Nickel Copper Alloy	Black Anodized Aluminum/Die Cast Zinc
Cable Jacket Material	PVC	PVC
Cable O.D.	7.4mm	7.4mm (4 Pin & 5 Pin)
Voltage Rating (Nominal)	250 V Max. @ 105 °C (221 °F)	250 V Max. @ 105 °C (221 °F)
Current Rating	Cables = 4.0 Amps Field Wireable = 4.0 Amps	Cables = 5.5 Amps Field Wireable = 8.0 Amps
Degree of Protection	IP67 (mated)	IP67 (mated)
Operating Temperature	-25 °C to 85 °C (-13 °F to 185 °F)	-40 °C to 85 °C (-40 °F to 185 °F)
Conductor Gauge	Cable = 18 AWG	Cable = 18 AWG
Bend Radius	Cable = 74mm	Cable = 74mm (4 Pin & 5 Pin)
Maximum Wire AWG	Field Wireable = 18 AWG	Field Wireable = 16 AWG
Wire Connection	Field Wireable = Screw Terminal	Field Wireable = Screw Terminal
PG 7 Range	4 – 6mm	N/A
PG 9 Range	6 – 8mm	5 – 13mm -One size fits all
PG 13.5 Range	N/A	5 – 13mm - One size fits all



7/8" MINI Drop Cables

7/8" MINI Straight 5 Pin Female Single Ended Cable - Shielded

MC0505MGD00000000 - 5 Meter
MC0510MGD00000000 - 10 Meter



M12 Drop Cables

M12 Straight 5 Pin Female Single Ended Cable - Shielded

TC0505MGD00000000 - 5 Meter
TC0510MGD00000000 - 10 Meter



7/8" MINI 3 Way "T"

3 Way 7/8" MINI "T"

MC0500000MT05000



Terminating Resistors "TR"

7/8" MINI & M12 Straight 5 Pin Male Terminators

TA05TR0000000000 - M12 Male
MA05TR0000000000 - MINI Male



7/8" MINI Field Wireable Connectors

7/8" MINI Straight 5 Pin Field Wireable Connectors

MC05F90000000000 - Female - Cable Gland - One size fits all
MA05F90000000000 - Male - Cable Gland - One size fits all

MINI Cable - Pin Out/Color Code

(Male View)

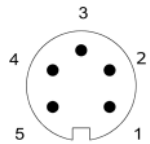

M12 Cable - Pin Out/Color Code

(Male View)

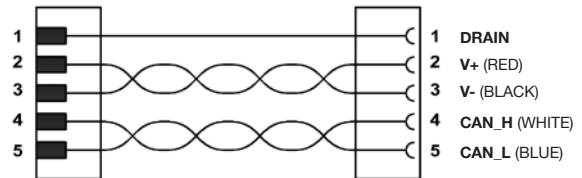
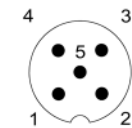

Technical Data	Cable	T & TR	Field Wireable
Molded Body/Insert	PVC	PVC	Body = Glass Filled Polyamide
Coupling Nut	Nickel Plated Brass or Anodized Aluminum	Clear Anodized Aluminum	Black Anodized Aluminum
Cable Jacket Material	PVC	N/A	N/A
Cable O.D.	MINI = 8mm M12 = 8mm	N/A	5 - 13mm - One size fits all
Voltage Rating (Nominal)	150 Volts	T = 300 Volts	600 Volts
Current Rating	MINI = 4.0 Amps MR = 3.0 Amps	T = 8.0 Amps TR = NA	8.0 Amps
Degree of Protection	IP65 (mated)	IP65 (mated)	IP65 (mated)
Operating Temperature	-40 °C to 80 °C (-40 °F to 176 °F)	-40 °C to 105 °C (-40 °F to 221 °F)	-40 °C to 90 °C (-40 °F to 194 °F)
Conductor Gauge	22 AWG Power 24 AWG Signal	N/A	16 - 22 AWG
Bend Radius Minimum	Cable = 72mm	N/A	N/A
Wire Connection	NA	N/A	Screw Terminal



M12 X-Coded Cables

M12 Straight 8 Pin Male Single Ended Cable - Shielded

XA0905MR0000071P – 5 Meter

XA0910MR0000071P – 10 Meter

M12 Straight 8 Pin Male Double Ended Cable - Shielded

XA0905MR0EA0971P – 5 Meter

XA0910MR0EA0971P – 10 Meter

M12 Straight 8 Pin Male to Male RJ45 Cable - Shielded

XA0905MR0VA0971P – 5 Meter

XA0910MR0VA0971P – 10 Meter

M12 X-Coded Field Wireable Connector

M12 Straight 8 Pin Male Field Wireable Connector w/ IDC

XA09F2000000081E – PG 9 Cable Gland

RJ45 Field Wireable Connector

RJ45 Field Wireable Connector w/ IDC

VA09F2000000071N – PG 9 Cable Gland

**M12 X-Coded Cable -
Pin Out/Color Code**

(Male View)

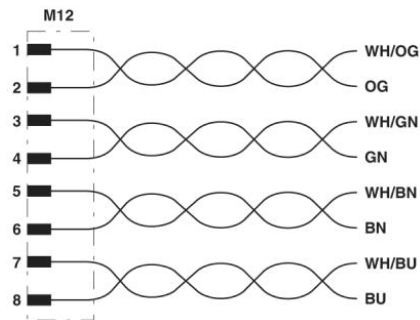
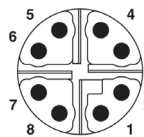

Technical Data	Cable	M12 Field Wireable	RJ45 Field Wireable
Molded Body/Insert	TPU/PE	Nickel Plated Zinc/PP	Housing = PA Carrier = PC
Coupling Nut	Nickel Plated Zinc	Nickel Plated Zinc	NA
Cable Jacket Material	PUR	NA	NA
Cable O.D.	6.4mm	Accepts 4.0 to 8.0mm	Accepts 4.5 to 8.0mm
Voltage Rating (Nominal)	48 Volts	48 Volts	50 Volts
Current Rating	0.5 Amps	0.5 Amps	1.75 Amps
Degree of Protection	IP65 (mated)	IP65 (mated)	IP 65 (mated)
Operating Temperature	-20 °C to 80 °C (-4 °F to 176 °F)	-40 °C to 85 °C (-40 °F to 185 °F)	-40 °C to 70 °C (-40 °F to 158 °F)
Conductor Gauge	26 AWG	26 AWG	26 – 24 AWG
Bend Radius	51.2mm	NA	NA
Wire Connection	NA	IDC	IDC



M12 D-Coded Cables

M12 Straight 4 Pin Male D-Coded Single Ended Cable

- QA0405MT00000000 – 5 Meter
- QA0410MT00000000 – 10 Meter



M12 Straight 4 Pin Male D-Coded Double Ended Cable

- QA0405MT0QA04000 – 5 Meter
- QA0410MT0QA04000 – 10 Meter



M12 Straight 4 Pin Male D-Coded to Male RJ45 Cable

- QA0405MT0VA04000 – 5 Meter
- QA0410MT0VA04000 – 10 Meter



M12 Straight 4 Pin Male D-Coded to RJ45 Female Socket Converter

- QA04D2MK0VC04000 – 0.2 Meter



M12 D-Coded Field Attachable Connectors

M12 Straight 4 Pin Male D-Coded Field Wireable Connector

- QA04F20000000000 – PG 9 Cable Gland – Screw Terminal

M12 Straight 4 Pin Male D-Coded Field Wireable Connector w/ IDC

- QA04F200R000071N – PG 9 Cable Gland – IDC



RJ45 Field Attachable Connector

RJ45 Field Wireable Connector w/ IDC

- VA08F200R000071N – PG 9 Cable Gland (1658435)

M12 D-Coded Cable - Pin Out/Color Code

(Male View)

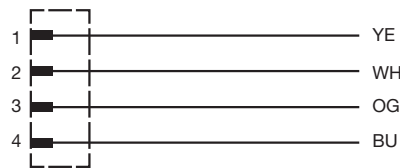
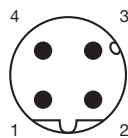

Technical Data	Cable	RJ45 Field Wireable	M12 Field Attachable
Molded Body/Insert	TPU/PE	Housing = PA Carrier = PC	Nickel Plated Zinc/PA 66
Coupling Nut	Nickel Plated Zinc	NA	Nickel Plated Brass
Cable Jacket Material	PVC	NA	NA
Cable O.D.	6.5mm	Accepts 4.5 to 8.0mm	Accepts 4.0 to 8mm
Voltage Rating (Nominal)	250 Volts	NA	60 Volts
Current Rating	4.0 Amps	1.75 Amps	Screw 4.0 Amps IDC 1.75 Amps
Degree of Protection	IP65 (mated), RJ45 – IP20	IP20	IP 65 (mated)
Operating Temperature	-40 °C to 70 °C (-40 °F to 158 °F)	-10 °C to 60 °C (14 °F to 140 °F)	-40 °C to 85 °C (-40 °F to 185 °F)
Conductor Gauge	22 & 24 AWG	22 AWG Solid/Stranded	Screw 24 – 18 AWG IDC 26 – 22 AWG
Bend Radius Minimum	19.5mm (fixed) 45.5mm (Flexible)	NA	NA
Wire Connection	NA	IDC	Screw Terminal, IDC



M12 D-Coded Cables

M12 Straight 4 Pin Male D-Coded Single Ended Cable

QA0405MK00000000 – 5 Meter

QA0410MK00000000 – 10 Meter

M12 Straight 4 Pin Male D-Coded Double Ended Cable

QA0405MK0QA04000 – 5 Meter

QA0410MK0QA04000 – 10 Meter

M12 Straight 4 Pin Male D-Coded to Male RJ45 Cable

QA0405MK0VA04000 – 5 Meter

QA0410MK0VA04000 – 10 Meter

M12 Straight 4 Pin Male D-Coded to RJ45 Female Socket Converter

QA04D2MK0VC04000 – 0.2 Meter

M12 D-Coded Field Wireable Connectors

M12 Straight 4 Pin Male D-Coded Field Wireable Connector

QA04F20000000000 – PG 9 Cable Gland – Screw Terminal

M12 Straight 4 Pin Male D-Coded Field Wireable Connector w/ IDC

QA04F2000000071N – PG 9 Cable Gland – Screw Terminal

RJ45 Field Wireable Connector

RJ45 Field Wireable Connector w/ IDC

VA08F2000000071N – PG 9 Cable Gland

**M12 D-Coded Cable -
Pin Out/Color Code**

(Male View)

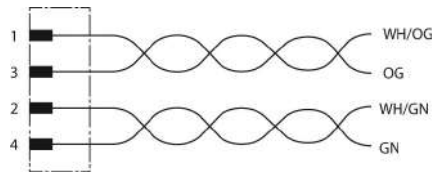
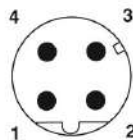

Technical Data	Cable	RJ45 Field Wireable	M12 Field Attachable
Molded Body/Insert	TPU, PA, PA66	Housing = PA Carrier = PC	Body = Nickel Plated Zinc Insert = PA 66
Coupling Nut	Nickel Plated Zinc or Brass	NA	Nickel Plated Brass
Cable Jacket Material	PUR or PVC	NA	NA
Cable O.D.	0.67 to 8.0mm	4.5 to 8.0mm	6.0 to 8.0mm
Voltage Rating (Nominal)	42 Volts	NA	60 Volts
Current Rating	1.5 Amps	1.75 Amps	Screw 4.0 Amps IDC 1.75 Amps
Degree of Protection	IP65 (mated)	IP20	IP 65 (mated)
Operating Temperature	-20 °C to 60 °C (-4 °F to 140 °F)	-20 °C to 70 °C (-4 °F to 158 °F)	-40 °C to 85 °C (-40 °F to 185 °F)
Conductor Gauge	26 & 24 AWG	26 – 22 AWG Solid/Stranded	Screw 24 – 18 AWG IDC 26 – 22 AWG
Bend Radius	40mm	NA	NA
Wire Connection	NA	IDC	IDC, Screw Terminal



M12 D-Coded Cables

M12 Straight 4 Pin Male D-Coded Double Ended Cable
QA0405MS0QA04000 – 5 Meter
QA0410MS0QA04000 – 10 Meter

M12 Straight 4 Pin Male D-Coded to Male RJ45 Cable
QA0405MS0VA04000 – 5 Meter
QA0410MS0VA04000 – 10 Meter

M12 Straight 4 Pin Male D-Coded to RJ45 Female Socket Converter
QA04D2MK0VC04000 – 0.2 Meter

M12 D-Coded Field Attachable Connectors

M12 Straight 4 Pin Male D-Coded Field Wireable Connector
QA04F20000000000 – PG 9 Cable Gland – Screw Terminal

M12 Straight 4 Pin Male D-Coded Field Wireable Connector w/ IDC
QA04F200R000071N – PG 9 Cable Gland – IDC

RJ45 Field Attachable Connectors

RJ45 Field Wireable Connector w/ IDC
VA08F200R000071N – PG 9 Cable Gland

M12 D-Coded Cable & RJ45 Pin Out/Color Code

(Male View)

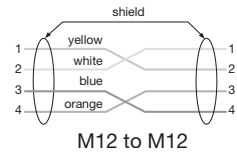
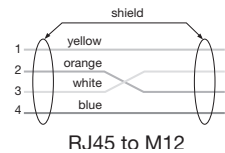
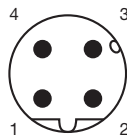

Technical Data	Cable	RJ45 Field Attachable	M12 Field Attachable
Molded Body/Insert	N/A	Housing = PA Carrier = PC	Body = Nickel Plated Zinc Insert = PA 66
Coupling Nut	Nickel Plated Zinc or Brass	N/A	Nickel Plated Brass
Cable Jacket Material	PUR	N/A	N/A
Cable O.D.	6.5mm	Accepts 4.5 to 8.0mm	Accepts 6.0 to 8mm
Voltage Rating (Nominal)	N/A	N/A	60 Volts
Current Rating	N/A	1.75 Amps	Screw 4.0 Amps IDC 1.75 Amps
Degree of Protection	IP65 (mated), RJ45 – IP20	IP20	IP 65 (mated)
Operating Temperature	-25 °C to 60 °C (-13 °F to 140 °F)	-10 °C to 60 °C (14 °F to 140 °F)	-40 °C to 85 °C (-40 °F to 185 °F)
Conductor Gauge	22 AWG	22 AWG Solid/Stranded	Screw 24 – 18 AWG IDC 26-22 AWG
Bend Radius Minimum	45.5mm	N/A	N/A
Wire Connection	N/A	IDC	Screw Terminal, IDC



M12 Reverse Key B-Coded Cables

M12 Straight 5 Pin Male Reverse Key Single Ended Cable - Shielded

RA0505MHP0000000 – 5 Meter
RA0510MHP0000000 – 10 Meter

M12 Straight 5 Pin Female Reverse Key Single Ended Cable - Shielded

RC0505MHP0000000 – 5 Meter
RC0510MHP0000000 – 10 Meter

M12 Straight 5 Pin MALE TO FEMALE Reverse Key EXTENSION CABLE

RC0505MHPRC05000 – 5 Meter
RC0510MHPRC05000 – 10 Meter

M12 Reverse Key B-Coded Field Wireable Connectors

M12 Straight 5 Pin Male Reverse Key Field Wireable Connector

RA05F200P0000000 – PG 9 Cable Gland

M12 Straight 5 Pin Female Reverse Key Field Wireable Connector

RC05F200P0000000 – PG 9 Cable Gland

M12 Reverse Key B-Coded Terminating Resistor

M12 Straight 5 Pin Male Reverse Key Terminating Resistor

RA05TR0000000000 – Male

M12 Reverse Key B-Coded Cable - Pin Out/Color Code

(Male View)

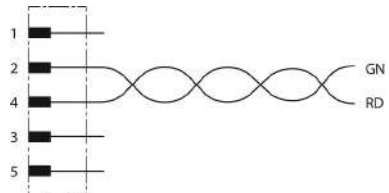
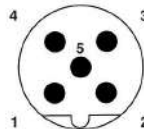

Technical Data	Cable	RJ45 Field Attachable	M12 Field Attachable
Molded Body/Insert	TPU	TR = TPU	Body = Nickel Plated Zinc Insert = PA 66
Coupling Nut	Nickel Plated Zinc	Nickel Plated Zinc or Brass	Nickel Plated Brass
Cable Jacket Material	PUR	N/A	N/A
Cable O.D.	7.4 mm	N/A	8.5 mm Max.
Voltage Rating (Nominal)	250 Volts	60 Volts	60 Volts
Current Rating	4.0 Amps	4.0 Amps	4.0 Amps
Degree of Protection	IP65 (mated)	IP65 (mated)	IP 65 (mated)
Operating Temperature	-20 °C to 80 °C (-4 °F to 176 °F)	-10 °C to 60 °C (14 °F to 140 °F)	-40 °C to 85 °C (-40 °F to 185 °F)
Conductor Gauge	24 AWG	N/A	18 AWG Maximum
Bend Radius	Cable = 78mm	N/A	N/A
Wire Connection	N/A	N/A	Screw Terminal



M12 D-Coded Cables

M12 Straight 4 Pin Male D-Coded Single Ended Cable

- QA0405MR00000000 – 5 Meter
- QA0410MR00000000 – 10 Meter

M12 Straight 4 Pin Male D-Coded Double Ended Cable

- QA0405MR0QA04000 – 5 Meter
- QA0410MR0QA04000 – 10 Meter

M12 Straight 4 Pin Male D-Coded to Male RJ45 Cable

- QA0405MR0VA04000 – 5 Meter
- QA0410MR0VA04000 – 10 Meter

M12 Straight 4 Pin Male D-Coded to RJ45 Female Socket Converter

- QA04D2MK0VC04000 – 0.2 Meter

M12 D-Coded Field Attachable Connectors

M12 Straight 4 Pin Male D-Coded Field Wireable Connector

- QA04F20000000000 – PG 9 Cable Gland – Screw Terminal

M12 Straight 4 Pin Male D-Coded Field Wireable Connector w/ IDC

- QA04F200R000071N – PG 9 Cable Gland – IDC

RJ45 Field Attachable Connectors

RJ45 Field Wireable Connector w/ IDC

- VA08F200R000071N – PG 9 Cable Gland

M12 D-Coded Cable - Pin Out/Color Code

(Male View)

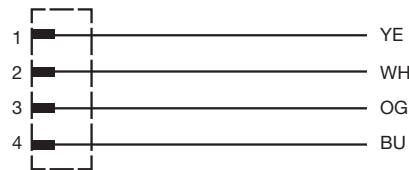
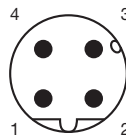

Technical Data	Cable	RJ45 Field Attachable	M12 Field Attachable
Molded Body/Insert	TPU	Housing = PA Carrier = PC	Body = Nickel Plated Zinc Insert = PA 66
Coupling Nut	Nickel Plated Zinc	N/A	Nickel Plated Brass
Cable Jacket Material	PVC	N/A	N/A
Cable O.D.	6.5 to 7.4mm	Accepts 4.5 to 8.0mm	Accepts 6.0 to 8mm
Voltage Rating (Nominal)	250 Volts	N/A	60 Volts
Current Rating	4.0 Amps	1.75 Amps	Screw 4.0 Amps IDC 1.75 Amps
Degree of Protection	IP65 (mated), RJ45 – IP20	IP20	IP 65 (mated)
Operating Temperature	-25 °C to 60 °C (-13 °F to 140 °F)	-10 °C to 60 °C (14 °F to 140 °F)	-40 °C to 85 °C (-40 °F to 185 °F)
Conductor Gauge	22 & 24 AWG	22 AWG Solid/Stranded	Screw 24-18 AWG IDC 26-22 AWG
Bend Radius Minimum	19.5mm (fixed) 45.5mm (Flexible)	N/A	N/A
Wire Connection	N/A	IDC	Screw Terminal, IDC

I/O Cables with SPEEDCON® Connector Technology



M12 Straight 4 Pin Male Single Ended Cable, Euro Color Code

TA04E5MIE000071P – 1.5 Meter

TA0403MIE000071P – 3 Meter

TA0405MIE000071P – 5 Meter



M12 90° 4 Pin Male Single Ended Cable, Euro Color Code

TB04E5MIE000071P – 1.5 Meter

TB0403MIE000071P – 3 Meter

TB0405MIE000071P – 5 Meter



M12 Straight 4 Pin Male to Female Cable Extension

TC04E5MIETA0471P – 1.5 Meter

TC0403MIETA0471P – 3 Meter



M12 Straight 3 Pin Male to M8 3 Pin Straight Female Extension

TC03E5MIEPA0371P – 1.5 Meter

TC0303MIEPA0371P – 3 Meter

I/O Connectors



M12 Straight 4 Pin Male Field Wireable Connector, IDC Connection

TA04F2000000081E – PG 9 Cable Gland w/ SPEEDCON® connector technology



M12 Straight 4 Pin Male Field Wireable Connector, Screw Terminal

TA04F10000000000 – PG 7 Cable Gland

TA04F20000000000 – PG 9 Cable Gland



M12 90° 4 Pin Male Field Wireable Connector, Screw Terminal

TB04F10000000000 – PG 7 Cable Gland

TB04F20000000000 – PG 9 Cable Gland

I/O Splitters



M12 to M12 "Y" Splitter, 21mm Spacing

TA0500000JC05000



M12 to M8 "Y" Splitter

TA0400000KC03000



M12 Cable Splitter, 2 Straight M12 Female Connectors
TA04D3MIEJC04000 – 0.3 Meter
TA04E5MIEJC04000 – 1.5 Meter
TA04O3MIEJC04000 – 3.0 Meter



M12 Cable Splitter, 2 Straight M8 Female Connectors
TA04D3MIEKC03000 – 0.3 Meter
TA04E5MIEKC03000 – 1.5 Meter
TA04O3MIEKC03000 – 3.0 Meter



Wire Stripper Tool
140-1097

I/O Cable Connector Pin Out Diagrams

M12 Cable - Pin Out/Color Code
TA04XXMIE0000000,
TB04XXMIE0000000
(Male View)

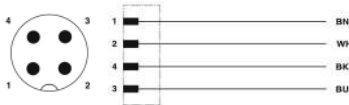

M12 Cable - Pin Out/Color Code
TC03XXMIEPA0371P
(Male to Female View)



M12 Cable - Pin Out/Color Code
TC03XXMIEPA0371P
(Male to Female View)



M12 to M12 "Y" Splitter - Pin Out
TA0500000JC05000
(Male to Female View)

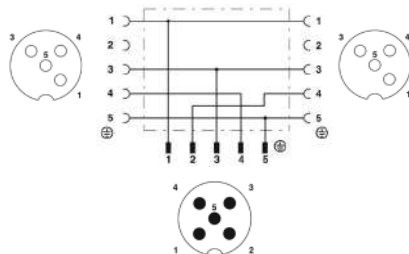

M12 to M8 "Y" Splitter - Pin Out
TA0400000KC03000
(Male to Female View)

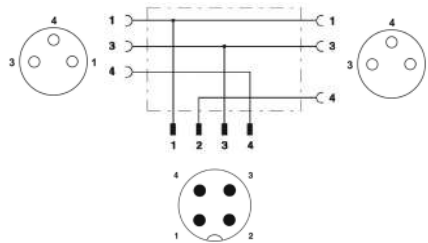

M12 Field Wireable (IDC) - Pin Out
TA04F2000000081E (SPEEDCON®)
(Male View)

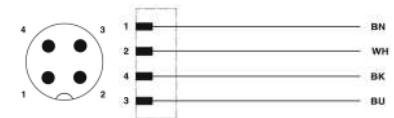

M12 to M12 Cable Splitter - Pin Out
TA04XXMIEJC04000
(Male to Female View)

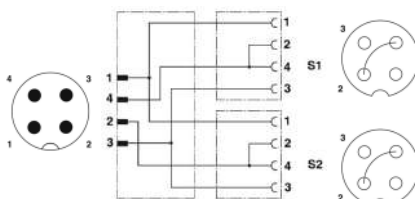

M12 to M8 Cable Splitter - Pin Out
TA04XXMIEKC03000
(Male to Female View)

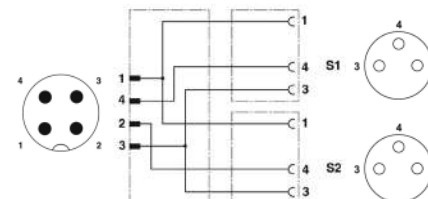

NOTE:
XX denotes allowable length.
See pages 101 & 102.

Cable and Connector Technical Data

Technical Data	M12 Cables	M12/M8 Cables	M12 Connectors
Molded Body/Insert	TPU	TPU	Polyamide (or) PA 66
Coupling Nut	Nickel Plated Zinc	Nickel Plated Zinc	Nickel Plated Zinc
Cable Jacket Material	PUR	PUR	NA
Cable O.D.	4.70mm	4.70mm	PG7 4.0 to 6.0mm PG9 4.0 to 8.0mm
Voltage Rating	250 Volts	60 Volts	50 Volts
Current Rating (Cond.)	4.0 Amps	3.0 Amps	4.0 Amps
Degree of Protection	IP65 (mated)	IP65 (mated)	IP67 (mated)
Operating Temperature	-25 °C to 80 °C (-13 °F to 176 °F) (fixed instl.)	-25 °C to 80 °C (-13 °F to 176 °F) (fixed instl.)	-25 °C to 80 °C (-13 °F to 176 °F)
Conductor Gauge	22 AWG	22 AWG	22 AWG Min. 18 AWG Max.
Bend Radius	47mm	47mm	NA

Technical Data	I/O "Y" Splitter	I/O Cable Splitter
Molded Body/Insert	TPU	TPU
Coupling Nut	Nickel Plated Zinc	Nickel Plated Zinc
Cable Jacket Material	NA	PUR
Cable O.D.	NA	4.40mm
Voltage Rating	60 Volts	60 Volts
Current Rating (Cond.)	3.0 Amps	3.0 Amps
Degree of Protection	IP67 (mated)	IP67 (mated)
Operating Temperature	-25 °C to 90 °C (-13 °F to 194 °F)	-25 °C to 80 °C (-13 °F to 176 °F)
Conductor Gauge	NA	22 AWG or 24 AWG
Bend Radius	NA	44mm

Technical Data	Wire Stripper
Use with	PVC Insulation
Stripping Range	28 AWG to 10 AWG
Cutting Range (Flexible)	10 AWG
Cutting Range (Rigid)	12 AWG



M23 19 Pin Cables

M23 19 Pin Female Single Ended Cable

CC1905MI00000000 – 5 Meter
CC1910MI00000000 – 10 Meter

M23 19 Pin Male Single Ended Cable

CE1905MI00000000 – 5 Meter
CE1910MI00000000 – 10 Meter

M23 19 Pin Female to Male Double Ended Cable

CC1902MIOCE19000 – 2 Meter
CC1905MIOCE19000 – 5 Meter
CC1910MIOCE19000 – 10 Meter

M23 19 Pin Connectors

M23 19 Pin Female Field Wireable Connector, Solder Cup

CC19000000000000 – PG 13.5 Cable Gland
--

M23 19 Pin Cable -
Pin Out/Color Code

(Male View)

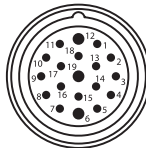

(Female View)

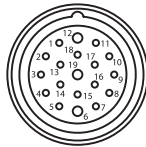

Conductor	Cable	Conductor	Cable
Pin 1	White	Pin 11	Gray/Pink
Pin 2	Brown	Pin 12	Green/Yellow
Pin 3	Green	Pin 13	White/Green
Pin 4	Yellow	Pin 14	Brown/Green
Pin 5	Gray	Pin 15	White/Yellow
Pin 6	Pink	Pin 16	Yellow/Brown
Pin 7	Blue	Pin 17	White/Gray
Pin 8	Red	Pin 18	Gray/Brown
Pin 9	Black	Pin 19	Red/Blue
Pin 10	Purple		

Technical Data	Cable	Connector
Molded Body/Insert	PA66	PBT
Coupling Nut	Gadolinium-Zinc Plated Brass	Gadolinium-Zinc Plated Brass/ Nickel Plated Brass
Cable Jacket Material	PUR/PVC	N/A
Cable O.D.	10.5mm	Accepts 10.0 to 12.0mm
Voltage Rating (Nominal)	150 Volts	150 Volts
Current Rating	8.0 Amps	8.0 Amps
Degree of Protection	IP65 (mated)	IP65 (mated)
Operating Temperature	-40 °C to 80 °C (-40 °F to 176 °F)	-20 °C to 80 °C (-4 °F to 176 °F)
Conductor Gauge	18 & 20 AWG	18 AWG
Bend Radius Minimum	78.75mm	N/A
Wire Connection	N/A	Solder Cup

Sub-bus Cables



M12 Straight 5 Pin Male to Female Sub-bus Cable - Shielded
TA0501MGDTC0571P – 1 Meter
TA0505MGDTC0571P – 5 Meter
TA0510MGDTC0571P – 10 Meter



M12 Straight 5 Pin Female Field Wireable Connector, Spring Cage
TC05F2000000071V – PG9 Cable Gland



M12 Straight 5 Pin Male Field Wireable Connector, Spring Cage
TA05F2000000071V – PG9 Cable Gland



M12 90° 5 Pin Female Field Wireable Connector, Spring Cage
TD05F2000000071V – PG9 Cable Gland



M12 90° 5 Pin Male Field Wireable Connector, Spring Cage
TB05F2000000071V – PG9 Cable Gland



Bulk Sub-bus Cable*
000550MGD0005000 – 50 Meter Length
0005A0MGD0005000 – 100 Meter Length

* NOTE: Length of field wired cables should not exceed the maximum length of 30 meters for total Sub-bus communications link. See appropriate technical manual for Sub-bus length requirements. The cable assemblies and Bulk cable are the only approved cables for the G3 Sub-bus link. See technical document TDG3SBWD1-0EN for proper installation and wiring of field wireable connectors.

Technical Data

Technical Data	Cable	Connectors	Bulk Cable
Molded Body / Insert	TPU	Zinc - Nickel Plated	N/A
Coupling Nut	Zinc - Nickel Plated	Brass - Nickel Plated	N/A
Cable Jacket Material	PUR	N/A	Gray RAL 7001
Cable O.D.	6.70mm	N/A	6.70mm
Voltage Rating (Nominal)	60 Volts	60 Volts	60 Volts
Current Rating	4.0 Amps	4.0 Amps	4.0 Amps
Degree of Protection	IP65 (mated)	IP65 (mated)	IP65 (terminated)
Operating Temperature	-40 °C to 80 °C (-40 °F to 176 °F)	-40 °C to 80 °C (-40 °F to 176 °F)	-20 °C to 75 °C (-4 °F to 167 °F)
Conductor Gauge	24 AWG Signal 22 AWG Power	26 – 20 AWG	24 AWG Signal 22 AWG Power
Bend Radius	67mm	N/A	67mm
No. of Bending Cycles	5 Million	N/A	5 Million

Example Sub-bus Layout and Cabling (DeviceNet™/CANopen® Network)

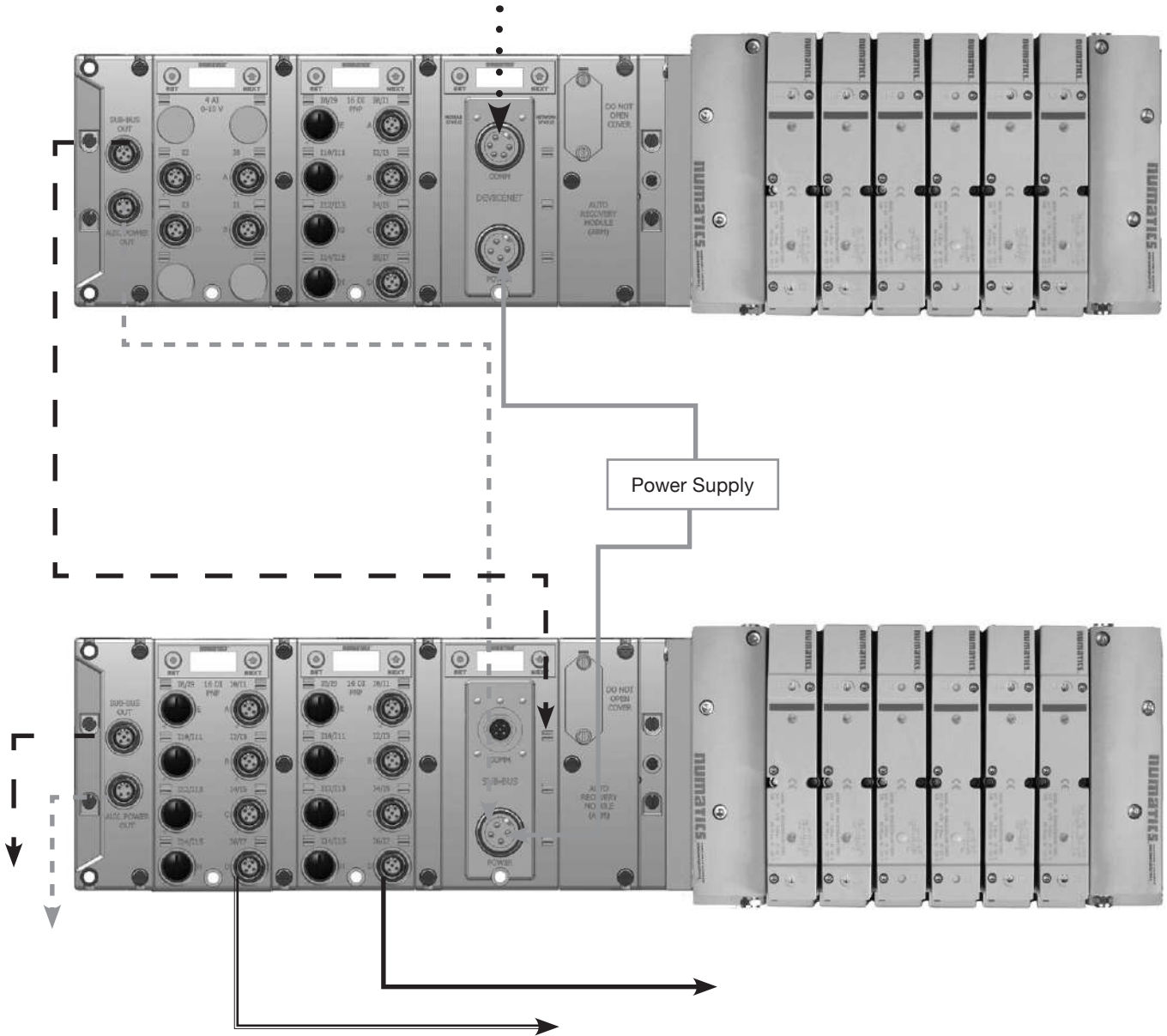

Cable	Description	Example Cable Part #	Page
—————	Power Cable	MC0405MAC0000000	97
- - - - -	Alternate Sub-bus Power Option	TA0401MA0MC0471T	98
.....	DeviceNet™/CANopen® Communication Cable	MC0505MGD0000000	100
—————	I/O Field Wireable Connector	TA04F2000000081E	107
—————	I/O Connector with Molded Cable	TA0405MIE000071P	107
- - - - -	Sub-bus Cable	TA0501MGDTC0571P	111

580 Fieldbus - Electronics Made Easy!

Innovative Graphic Display is used for easy commissioning, visual status & diagnostics.

Commissioning Capabilities

- Set network address (including IP & Subnet mask for Ethernet)
- Set baud rate
- Set brightness
- Set factory defaults

Visual Diagnostics

- Shorted and open load detection
- Shorted sensor/cable detection
- Low & missing power detection
- Self-test activation
- Log of network errors

580 Fieldbus Communications Electronics

Why use Numatics Fieldbus communications electronics?

Modular Reality...

- No internal wiring simplifies assembly
- Power connector allows output power to be removed while inputs and communications are left active
- IP65 protection
- Up to 128 valve solenoids per manifold
- Direct Connection to Emerson DeltaV™ with Electronic Marshalling platform via the 580 CHARM Node
- 500 Series valve compatibility

Supported Protocols

- | | |
|--------------------|-----------------------|
| • CANopen® | • Ethernet POWERLINK® |
| • DeviceNet™ | • IO-Link®* |
| • EtherCAT® | • PROFIBUS™ DP |
| • EtherNet/IP™ | • PROFINET™ |
| • EtherNet/IP™ DLR | |

* IO-Link® is a communication network that requires an IO-Link® Master with a higher level fieldbus or Ethernet communication protocol.



Graphic Display for configuration & diagnostics



EtherNet/IP and DeviceNet are trademarks of ODVA.
 Ethernet POWERLINK is a registered trademark of Bernecker + Rainer Industrie – Elektronik Ges.m.b.H.
 CANopen is a registered Community trademark of CAN in Automation e.V.
 PROFIBUS and PROFINET are trademarks and IO-Link is a registered trademark of Profibus Nutzerorganisation e.V.
 EtherCAT is a registered trademark of Beckhoff Automation GmbH.

CANopen®

CANopen® is an open protocol based on Controller Area Network (CAN). It was designed for motion-oriented machine control networks but has migrated to various industrial applications. CAN in Automation (CIA) is the international users' and manufacturers' organization that develops and supports CAN-based protocols.

Numatics' 580 nodes for CANopen® have an integrated graphic display.

More information about CANopen® and the CIA can be found at: www.can-cia.org.



Description	Replacement Part Number
CANopen® communications module (node)	P580AECO1010A00

Technical Data

Electrical Data	Voltage	Current
Node Power	24 VDC +/- 10%	0.007 Amps
Bus Power	11 – 25 VDC	0.05 Amps
Valves	24 VDC +/- 10%	4 Amps Maximum
Power Connector	A-Coded 4 Pin M12 (Male)	
Communication Connector	A-Coded 5 Pin M12 (Male)	
LEDs	Module Status and Network Status	

Operating Data	
Temperature Range (ambient)	-23 °C to 46 °C (-10 °F to 115 °F)
Humidity	95% relative humidity, non-condensing
Vibration/Shock	IEC 60068-2-27, IEC60068-2-6
Moisture Protection	IP65

Configuration Data	
Graphic Display	Display used for setting Node Address, Baud Rate, Fault/Idle Actions, and all other system settings
Maximum Valve Solenoid Outputs	32

Network Data	
Supported Baud Rates	125K Baud, 250K Baud, 500K Baud, 1M Baud
Bus Connector	Single key 5 Pin M12 (male)
Diagnostics	Power, short, open load conditions are monitored
Special Features	Fail-safe device settings

Weight	
CANopen® Communications Module	320g/11.3 oz

DeviceNet™

DeviceNet™ is an open bus fieldbus communication system developed by Allen-Bradley based on Controller Area Network (CAN) technology. The governing body for DeviceNet™ is the Open DeviceNet™ Vendors Association (ODVA). The ODVA controls the DeviceNet™ specification and oversees product conformance testing.

Numatics' 580 nodes for DeviceNet™ have an integrated graphic display.

They have been tested and approved for conformance by the ODVA.

More information about DeviceNet™ and the ODVA can be obtained from the following website: www.odva.org



Description	Replacement Part Number
DeviceNet™ Communications Module (node)	P580AEDN1010A00

Technical Data

Electrical Data	Voltage	Current
Node Power	24 VDC +/- 10%	0.05 Amps
Bus Power	11 – 25 VDC	0.05 Amps
Valves	24 VDC +/- 10%	4 Amps Maximum
Power Connector	A-Coded 4 Pin M12 (Male)	
Communication Connector	A-Coded 5 Pin M12 (Male)	
LEDs	Module Status and Network Status	

Operating Data	
Temperature Range (ambient)	-23 °C to 46 °C (-10 °F to 115 °F)
Humidity	95% relative humidity, non-condensing
Vibration/Shock	IEC 60068-2-27, IEC60068-2-6
Moisture Protection	IP65

Configuration Data	
Graphic Display	Display used for setting Node Address, Baud Rate, Fault/Idle Actions, and all other system settings
Maximum Valve-Solenoid Outputs	32

Network Data	
Supported Baud Rates	125K Baud, 250K Baud, 500K Baud, with Auto-Baud detection
Supported Connection Type	Polled, Cyclic, Change of State (COS) and combination Message Capability
Bus Connector	Single key 5 Pin M12 (male)
Diagnostics	Power, short, open load conditions are monitored
Special Features	Supports Auto-Device Replacement (ADR) and fail-safe device settings

Weight	
DeviceNet™ Communications Module	320g/11.3 oz

EtherCAT®

EtherCAT® is an open ethernet based fieldbus protocol developed by Beckhoff. EtherCAT® sets new standards for real-time performance and topology flexibility with short data update/cycle times and low communication jitter.

Numatics' 580 EtherCAT® node has an integrated graphic display for simplified commissioning and diagnostics.

The 580 nodes for EtherCAT® have been designed and tested to conform with EtherCAT® specifications set forth by the ETG.

More information regarding EtherCAT® can be obtained from the following website: www.ethercat.org



Description	Replacement Part Number
EtherCAT® Communications Module (node)	P580AEEC1010A00

Technical Data

Electrical Data	Voltage	Current
Node Power	24 VDC +/- 10%	0.11 Amps
Valves	24 VDC +/- 10%	4 Amps Maximum
Power Connector	Single key 5 Pin M12 (male)	
Communication Connector	Two D-Coded 4 Pin M12 (female)	
LEDs	Error/Run	

Operating Data	
Temperature Range	-23 °C to 46 °C (-10 °F to 115 °F)
Humidity	95% relative humidity, non-condensing
Vibration/Shock	IEC 60068-2-27, IEC 60068-2-6
Moisture	IP65

Configuration Data	
Graphic Display	Display used for Subnet Mask, Fault/Idle Actions, and all other system settings
Maximum Valve Solenoid Outputs	128 for 501 and 80 for 502/503

Network Data	
Supported Baud Rates	10 Mbit/100 Mbit
Bus Connector	Two D-Coded 4 Pin M12 (female)
Diagnostics	Power, short, open load conditions and module health and configuration are monitored
Special Features	Integrated web server, fail-safe device settings

Weight	
EtherCAT® Communications Module	332g/11.7 oz

EtherNet/IP™

Ethernet used throughout the world to network millions of PCs has now evolved into a viable industrial network. Ethernet is an open architecture high-level communication network that meets the demands of today's industrial applications requiring high-speed (10/100 Mbit/s), high-throughput and flexibility. Additionally, Ethernet technology can integrate an on-board Web server, which can make the node readily accessible to any standard Web browser for configuration, testing and even retrieval of technical documentation.

Numatics' 580 nodes for Ethernet have an integrated graphic display.

The 580 EtherNet/IP™ nodes have been tested and approved for conformance by the ODVA.

More information about EtherNet/IP™ and the ODVA can be obtained from the following website:
Open Device Vendors Association (ODVA) www.odva.org



Description	Replacement Part Number
Ethernet/IP™ Communications Module (node)	P580AEEP1010A00

Technical Data

Electrical Data	Voltage	Current
Node Power	24 VDC +/- 10%	0.05 Amps
Valves	24 VDC +/- 10%	4 Amps Maximum
Power Connector	A-Coded 4 Pin M12 (male)	
Communication Connector	D-Coded 4 Pin M12 (female)	
LEDs	Module Status, Network Status and Activity/Link	

Operating Data	
Temperature Range (ambient)	-23 °C to 46 °C (-10 °F to 115 °F)
Humidity	95% relative humidity, non-condensing
Vibration/Shock	IEC 60068-2-27, IEC60068-2-6
Moisture Protection	IP65

Configuration Data	
Graphic Display	Display used for setting IP Address, Subnet mask, Fault/Idle Actions, DHCP/BootP and all other system settings
Maximum Valve-Solenoid Outputs	32

Network Data	
Supported Baud Rates	10 Mbit/100 Mbit
Bus Connector	D-Coded 4 Pin M12 (female)
Diagnostics	Power, short, open load conditions
Special Features	Integrated web server, fail-safe device settings, HTTP, FTP, and UNICAST (for EtherNet/IP)

Weight	
Ethernet/IP™ Communications Module	320g/11.3 oz

EtherNet/IP™ DLR

EtherNet/IP™ used throughout the world to network millions of PCs has now evolved into a viable industry network. EtherNet/IP™ is an open architecture high-level communication network that meets the demands of today's industrial applications requiring high-speed (10/100 Mbit/s), high-throughput and flexibility. Additionally, EtherNet/IP™ technology can integrate an on-board Web server, which can make the node readily accessible to any standard Web browser for configuration, testing and even retrieval of technical documentation.

Numatics' 580 EtherNet/IP™ DLR (Device Level Ring) node with integrated display, has an embedded switch which allows the unit to be used in simplified networks with linear topology configurations (daisy chain). This technology alleviates the need for an external Ethernet switch device in a single subnet configuration. Additionally, the DLR compatibility allows the node to be used in a fault tolerant "ring" network, when using appropriate EtherNet/IP™ DLR scanners. DLR configuration allows communication recovery from a single point failure on the network ring (e.g. failed network connection or cable).

The 580 EtherNet/IP™ nodes have been tested and approved for conformance by the ODVA.

More information about EtherNet/IP and the ODVA can be obtained from the following website: www.odva.org



Description	Replacement Part Number
EtherNet/IP™ DLR Communications Module (node)	P580AEED1010A00

Technical Data

Electrical Data	Voltage	Current
Node Power	24 VDC +/- 10%	0.09 Amps
Valves	24 VDC +/- 10%	4 Amps Maximum
Power Connector	A-Coded 4 Pin M12 (male)	
Communication Connector	Two D-Coded 4 Pin M12 (female)	
LEDs	Module Status, Network Status and Activity/Link	

Operating Data	
Temperature Range	-23 °C to 46 °C (-10 °F to 115 °F)
Humidity	95% relative humidity, non-condensing
Vibration/Shock	IEC 60068-2-27, IEC 60068-2-6
Moisture	IP65

Configuration Data	
Graphic Display	Display used for setting IP address, Subnet Mask, Fault/Idle Actions, and all other system settings
Maximum Valve Solenoid Outputs	128 for 501 and 80 for 502/503

Network Data	
Supported Baud Rates	10 Mbit/100 Mbit
Bus Connector	Two D-Coded 4 Pin M12 (female)
Diagnostics	Power, short, open load conditions and module health and configuration are monitored
Special Features	Embedded two port switch, Device Level Ring (DLR) compatibility, Linear network topology, fail-safe device settings, integrated web server, HTTP, TFTP, UNICAST

Weight	
EtherNet/IP™ DLR Communications Module	337g/11.9 oz

Ethernet POWERLINK®

Ethernet POWERLINK® is an open fieldbus protocol designed by B&R for communication between automation control systems and the device level.

Numatics' 580 nodes for Ethernet POWERLINK® have an integrated graphic display.

The 580 Ethernet POWERLINK® nodes have been designed and tested to conform to the Ethernet POWERLINK® specifications available at EPSG group (Ethernet Powerlink Standardization Group). The certification process ensures interoperability for all Ethernet POWERLINK® devices and compatibility with B&R systems.

More information regarding Ethernet POWERLINK® can be obtained from the following website: www.ethernet-powerlink.org

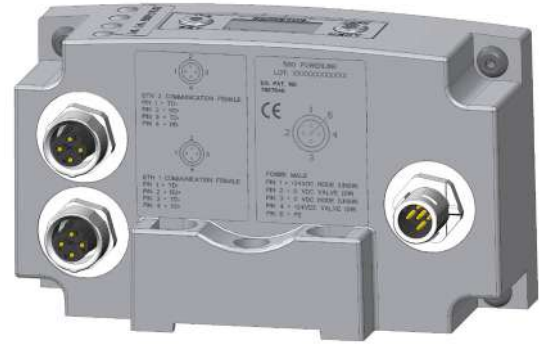

Description	Replacement Part Number
POWERLINK® Communications Module (node)	P580AEPL1010A00

Technical Data

Electrical Data	Voltage	Current
Node Power	24 VDC +/- 10%	0.09 Amps
Valves	24 VDC +/- 10%	4 Amps Maximum
Power Connector	Single Key 5 Pin M12 (male)	
Communication Connector	Two D-Coded 4 Pin M12 (female)	
LEDs	Error, Status and Activity/Link	

Operating Data	
Temperature Range (ambient)	-23 °C to 46 °C (-10 °F to 115 °F)
Humidity	95% relative humidity, non-condensing
Vibration/Shock	IEC 60068-2-27, IEC60068-2-6
Moisture	IP65

Configuration Data	
Graphic Display	Display used for setting IP address, Subnet Mask, Fault/Idle Actions, and all other system settings
Maximum Valve Solenoid Outputs	128 for 501 and 80 for 502/503

Network Data	
Supported Baud Rates	10 Mbit/100 Mbit
Bus Connector	Two D-Coded 4 Pin M12 (female)
Diagnostics	Power, short, open load conditions and module health and configuration are monitored
Special Features	Integrated web server and fail-safe device settings

Weight	
POWERLINK® Communications Module	328g/11.6 oz

IO-Link® (Class A & Class B)

IO-Link® is a globally standardized IO technology (IEC 61131-9) developed primarily for communication with smart sensors and actuators that can also be used with valves and other field devices. IO-Link® is used to individually link field devices and resides below the I/O level. An IO-Link® Master with a higher level fieldbus or Ethernet communication protocol is required. The IO-Link Consortium, which is a technical committee within PROFIBUS™ & PROFINET™ International (PI), oversees and manages IO-Link® specifications.

Numatics' IO-Link® communications node offers both event based as well as standard I/O mapped diagnostics, requires minimal commissioning, and is compatible with distributed modular I/O. Supports both Class A (4 Pin) and Class B (5 Pin with isolated ground) communication port types.

More information regarding IO-Link® can be obtained from the following website: www.io-link.com



Description	Replacement Part Number
IO-Link® Class A (4 Pin) Communications Module (node)	P580AELM1010A00
IO-Link® Class B (5 Pin) Communications Module (node)	P580AELM2010A00

Technical Data

Electrical Data	Voltage	Current
Node Power	24 VDC +/- 10%	0.020 Amps
Valves	24 VDC +/- 10%	4 Amps Maximum
Power and Communication Connector	Class A: A-Coded 4 Pin M12 (male)/Class B: A-Coded 5 Pin M12 with isolated ground (male)	
LEDs	Valve Power, Node Power and Communication	

Operating Data	
Temperature Range (ambient)	-23 °C to 46 °C (-10 °F to 115 °F)
Humidity	95% Relative Humidity, Non-condensing
Vibration/Shock	IEC 60068-2-27, IEC 60068-2-6
Moisture	IP65

Configuration Data	
Maximum Valve Solenoid Outputs	32

Network Data	
Supported Baud Rates	38.4K
Diagnostics	Power, short, open load conditions with both standard I/O mapped diagnostics and event based diagnostics
Special Features	Fail-safe device settings

Weight	
IO-Link® Communications Module	Class A: 298g/10.5oz, Class B: 303g/10.7oz

PROFIBUS™ DP

PROFIBUS™ DP is a vendor-independent, open fieldbus protocol designed for communication between automation control systems and distributed I/O at the device level.

Numatics' 580 nodes for PROFIBUS™ DP have an integrated graphic display.

The 580 nodes for PROFIBUS™ DP have been designed and tested to conform to the PROFIBUS™ standard EN50170. Certification has been done by the PROFIBUS™ Interface Center (PIC) according to the guidelines determined by the PROFIBUS™ Trade Organization (PTO). The certification process ensures interoperability for all PROFIBUS™ devices.

More information regarding PROFIBUS™ can be obtained from the following website: www.profibus.com



Description	Replacement Part Number
PROFIBUS™ DP Communications Module (node)	P580AEPT1010A00

Technical Data

Electrical Data	Voltage	Current
Node Power	24 VDC +/- 10%	0.08 Amps
Valves	24 VDC +/- 10%	4 Amps Maximum
Power Connector	A-Coded 5 Pin M12 (male)	
Communication Connector	Single reverse key (B-Coded) 5 Pin M12 (1 male and 1 female)	
LEDs	Module Status and Network Status	

Operating Data	
Temperature Range (ambient)	-23 °C to 46 °C (-10 °F to 115 °F)
Humidity	95% relative humidity, non-condensing
Vibration/Shock	IEC 60068-2-27, IEC60068-2-6
Moisture Protection	IP65

Configuration Data	
Graphic Display	Display used for setting Node Address, Fault/Idle Actions, and all other system settings
Maximum Valve-Solenoid Outputs	128 for 501 and 80 for 502/503

Network Data	
Supported Baud Rates	Auto-Baud (From 9.6k to 12m Baud)
Bus Connector	Single reverse key (B-Coded) 5 Pin M12 (1 male and 1 female)
Diagnostics	Power, short, open load conditions and module health are monitored

Weight	
PROFIBUS™ DP Communications Module	326g/11.5 oz

PROFINET™

PROFINET™ is the innovative open standard for Industrial Ethernet, development by Siemens and the Profibus™ User Organization (PNO). PROFINET™ complies to IEC 61158 and IEC 61784 standards. PROFINET™ products are certified by the PNO user organization, guaranteeing worldwide compatibility.

Numatics' 580 nodes for PROFINET™ IO (PROFINET™ RT) have an integrated graphic display.

PROFINET™ is based on Ethernet and uses TCP/IP and IT standards and complements them with specific protocols and mechanisms to achieve Real Time performance.

More information regarding PROFINET™ can be obtained from the following website: www.profibus.com



Description	Replacement Part Number
PROFINET™ Communications Module (node)	P580AEPN1010A00

Technical Data

Electrical Data	Voltage	Current
Node Power	24 VDC +/- 10%	0.11 Amps
Valves	24 VDC +/- 10%	4 Amps Maximum
Power Connector	A-Coded 5 Pin M12 (male)	
Communication Connector	Two D-Coded 4 Pin M12 (female)	
LEDs	System Fault, Bus Fault and Activity Link	

Operating Data	
Temperature Range (ambient)	-23 °C to 46 °C (-10 °F to 115 °F)
Humidity	95% relative humidity, non-condensing
Vibration/Shock	IEC 60068-2-27, IEC60068-2-6
Moisture Protection	IP65

Configuration Data	
Graphic Display	Display used for setting IP Address, Subnet Mask, Fault/Idle Actions, and all other system settings
Maximum Valve-Solenoid Outputs	128 for 501 and 80 for 502/503

Network Data	
Supported Baud Rates	10 Mbit/100 Mbit
Bus Connector	Two D-Coded 4 Pin M12 (Female)
Diagnostics	Power, short, open load conditions and module health and configuration are monitored
Special Features	Integrated web server, Integrated 2 port switch, fail-safe device settings

Weight	
PROFINET™ Communications Module	335g/11.8 oz

580 CHARM Node

The 580 CHARM node provides direct connectivity of pneumatic manifolds to DeltaV with Electronic Marshalling. The node connects directly to the CHARM I/O baseplate via 2 cables which attach to CHARM column extender. The cables provide redundant communication and power to the pneumatic manifold and allow the 580 CHARM node to be directly controlled by DeltaV Explorer. The 580 CHARM node configures the same as a DO CHARM.



Description	Replacement Part Number
580 CHARM Module (node)	P580AECH1010A00

Technical Data

Electrical Data	Voltage	Current
Bus Power	6.3 V	100 mA
Valve Power	24 V	1.07 Amps
Power and Bus Connector	A-Coded 5 Pin M12 Male	
LEDs	Module Status and Network Status	

Operating Data	
Temperature Range	-23 °C to 46 °C (-10 °F to 115 °F)
Humidity	95% Relative Humidity, Non-condensing
Vibration/Shock	IEC 60068-2-27, IEC 60068-2-6
Moisture	IP65

Configuration Data	
Graphic Display	Display used for setting CHARM address and other system settings
Maximum Valve Solenoid Outputs	48 for 501/502/503

Network Data	
Power and Bus Connector	A-Coded 5 Pin M12 Male
Diagnostics	Power, short, open load conditions are monitored

Weight	
CHARM Communications Module	320g/11.3 oz

580 CHARM Power and Communication Cables and Accessories	Replacement Part Number
1.5 Meter Cables with M12 and Sub-D Connectors	P599AF519387001
0.5 Meter Cables with M12 and Sub-D Connectors	P599AF519387002
Valve Power Isolator	P599AF516881001

NOTE: Cables are not included with node and must be ordered separately.

Dimensions: mm (inches)

580 Fieldbus Manifold Assembly

503 Series Valve Manifold Assembly with 580 Electronics

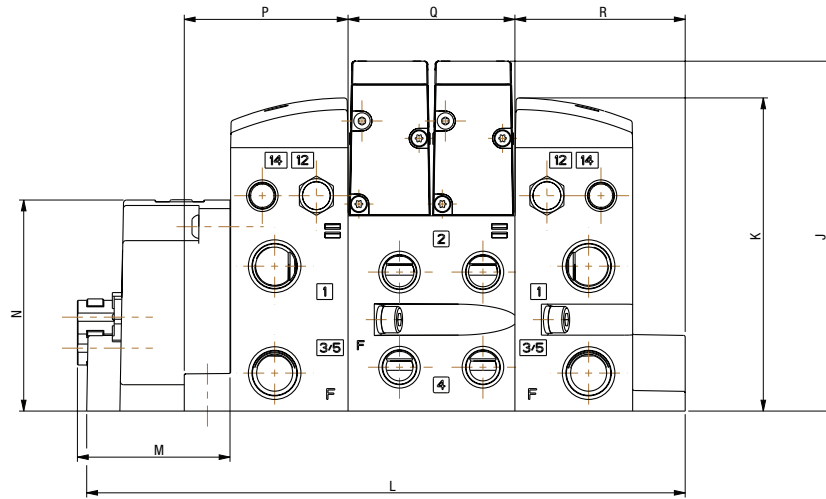
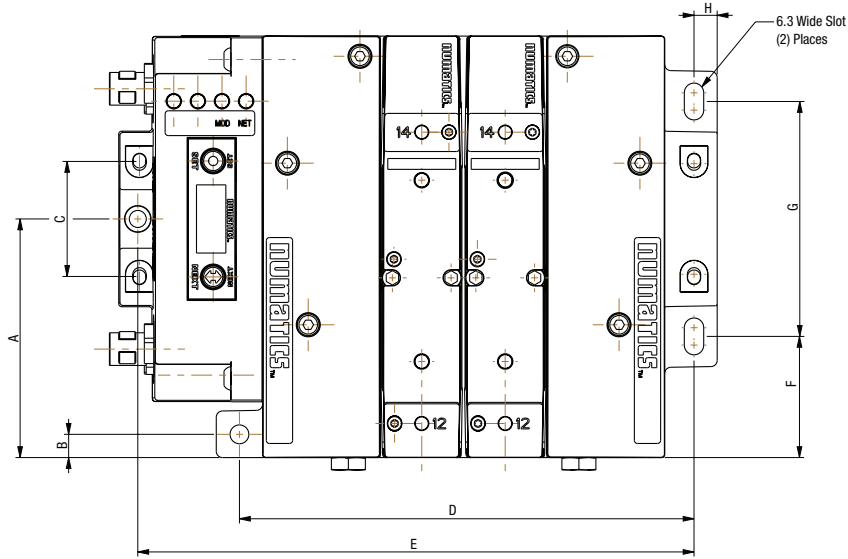

A	B	C	D	E	F	G	H	J	K	L	M	N	P	Q	R
77 (3.032)	7.5 (0.295)	38 (1.5)	147.1 (5.79)	180 (7.087)	39.1 (1.539)	75.8 (2.984)	7.5 (0.295)	113 (4.449)	101 (3.976)	194 (7.638)	49.4 (1.945)	68.1 (2.681)	53 (2.087)	54 (2.13)	55.1 (2.169)

* For valve manifold dimensions refer to Valve Series product catalogs

How to Order: Manifold Assembly

K 501 A V 8 D 2 0 0 V A00

Port Type

- ¹ 8 = NPTF
- ¹ G = ISO 228/1-G
- K = Push-In Fittings

Product Series

- 501 = 11mm Valve
- 502 = 18mm Valve
- 503 = 22mm Valve

Revision

- A = Initial Release

Product Type

- V = Valve Manifold Assembly

Electronics

- 8 = 580 Fieldbus Electronics
- D = CHARMs Electronics

² Number of Valve Stations

- | | |
|------------------|------------------|
| A = NA/33/65/97 | Q = 17/49/81/113 |
| B = 2/34/66/98 | R = 18/50/82/114 |
| C = 3/35/67/99 | S = 19/51/83/115 |
| D = 4/36/68/100 | T = 20/52/84/116 |
| E = NA/37/69/101 | U = 21/53/85/117 |
| F = 6/38/70/102 | V = 22/54/86/118 |
| G = 7/39/71/103 | W = 23/55/87/119 |
| H = 8/40/72/104 | X = 24/56/88/120 |
| I = 9/41/73/105 | Y = 25/57/89/121 |
| J = 10/42/74/106 | Z = 26/58/90/122 |
| K = 11/43/75/107 | 2 = 27/59/91/123 |
| L = 12/44/76/108 | 3 = 28/60/92/124 |
| M = 13/45/77/109 | 4 = 29/61/93/125 |
| N = 14/46/78/110 | 5 = 30/62/94/126 |
| O = 15/47/79/111 | 6 = 31/63/95/127 |
| P = 16/48/80/112 | 7 = 32/64/96/128 |

Options

- A00 = Standard (No Options)
- MUF = Muffler in End Plates
- DRM = DIN Rail Mount
- DWM = DIN Rail with (MUF) Muffler in End Plates
- 14X = External Pilot Supply from Port #14
- D12 = (14X) External Pilot Supply from Port #14 and (MUF) Muffler in End Plates
- D14 = (14X) External Pilot Supply from Port #14 and (DRM) DIN Rail Mount
- F06 = (14X) External Pilot Supply from Port #14, (MUF) Muffler in End Plates, and (DRM) DIN Rail Mount

End Plate Style

- V = Vertical

³ Second Valve Series

- 0 = No Second Valve Series
- 1 = 501
- 2 = 502

Valve Station Adder

- 0 = No Adder
- 1 = 32+
- 2 = 64+
- 3 = 96+

⁴ Port Size

- 1 = 1/8
- 2 = 1/4
- G = 5/16
- 3 = 3/8
- 4 = 1/2
- H = 8mm
- K = 10mm
- M = 12mm

¹ Port Type 8 & G only available in Port Size 3/8 for 502 & 503 and 1/8 for 501

² 501 not available with 2 stations, 502 and 503 only available with an even number of stations and with up to 80 valve solenoids

³ With 502 11mm (501) valve available, with 503 18mm (502) valve available

⁴ 501 Port Sizes 1/8, 1/4, 5/16, 8mm, 502 and 530 Port Sizes 3/8, 1/2, 10 and 12mm

How to Order

Electronics

P 580 A E DN1 0 1 0 A00

Product Series

- 580 = 580 Series Electronics

Revision

- A = Initial Release

Product Type

- E = Electronics

Options

- A00 = Standard (No Options)
- DRM = DIN Rail Mount

Connector Type

- 1 = M12 Connector

Protocol

- CO1 = CANopen
- DN1 = DeviceNet
- EC1 = EtherCAT
- EP1 = EtherNet/IP
- PN1 = PROFINET™
- PT1 = PROFIBUS™ DP
- PL1 = Ethernet POWERLINK
- LM1 = IO-Link Class A (4 Pin)
- LM2 = IO-Link Class B (5 Pin)
- CH1 = CHARM



Ordering Valve Manifold Assemblies with 580 Electronics
For Valve Series

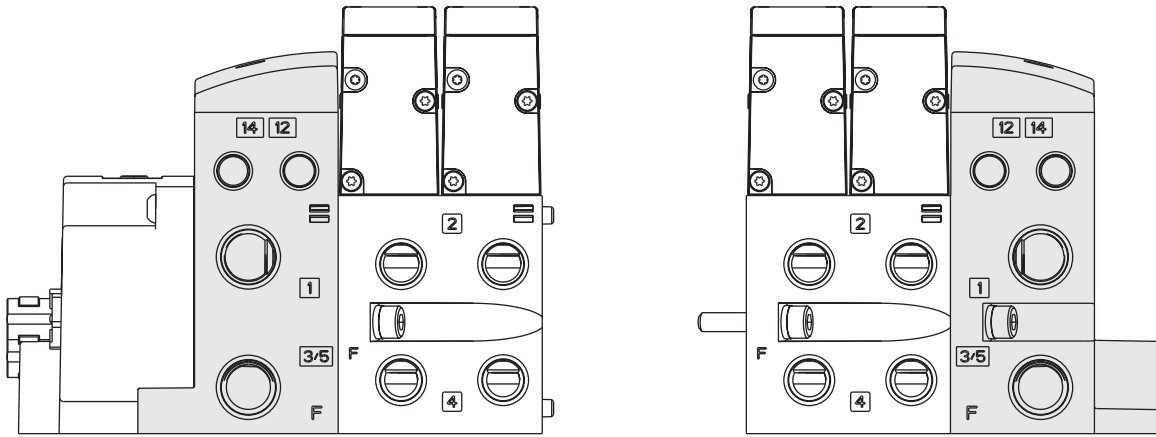

Shaded components are described by the manifold assembly number (see previous page). The communications module is described by the electronic interface model number designation (see previous page).

Each valve station is listed in sequential order from left to right when facing the port side of the manifold as shown.

NOTE:

Up to 128 solenoid outputs are available. Either 128 single solenoid valves or 64 double solenoid valves or any combination of singles and doubles not to exceed 128 outputs can be specified.

Example Order - 503 Shown

Assembly Kit	8503AV8H300VMUF
Valve Station #1	R503A2B40MA00F1
Valve Station #2	R503A2B40MA00F1
Mounting #1	8503AMM22MA0010
Valve Station #3	R503A2B40MA00F1
Valve Station #4	R503A2B40MA00F1
Mounting #2	8503AMM22MA0010
Valve Station #5	R503A2B40MA00F1
Valve Station #6	R503A2B40MA00F1
Mounting #3	8503AMM22MA0010
Valve Station #7	R503A2B40MA00F1
Valve Station #8	R503A2B40MA00F1
Mounting #4	8503AMM22MA0010
Electronics	P580AEDN1010A00
	Assembled

M12 A-Coded Cables



M12 Straight 4 Pin Female Single Ended Cable, Euro Color Code

TC0405MAE0000000 – 5 Meter
TC0410MAE0000000 – 10 Meter

M12 Straight 5 Pin Female Single Ended Cable, Euro Color Code

TC0505MAE0000000 – 5 Meter
TC0510MAE0000000 – 10 Meter

M12 90° 4 Pin Female Single Ended Cable, Euro Color Code

TD0405MAE0000000 – 5 Meter
TD0410MAE0000000 – 10 Meter

M12 90° 5 Pin Female Single Ended Cable, Euro Color Code

TD0505MAE0000000 – 5 Meter
TD0510MAE0000000 – 10 Meter

M12 A-Coded Field Wireable Connectors



M12 Straight 4 Pin Female Field Wireable Connector

TC04F10000000000 – PG 7 Cable Gland
TC04F20000000000 – PG 9 Cable Gland

M12 Straight 5 Pin Female Field Wireable Connector

TC05F10000000000 – PG 7 Cable Gland
TC05F20000000000 – PG 9 Cable Gland

M12 90° 4 Pin Female Field Wireable Connector

TD04F10000000000 – PG 7 Cable Gland
TD04F20000000000 – PG 9 Cable Gland

M 12 90° 5 Pin Female Field Wireable Connector

TD05F10000000000 – PG 7 Cable Gland
TD05F20000000000 – PG 9 Cable Gland

Technical Data	Cable	Field Wireable	Pin Out/Color Code
Molded Body/Insert	PVC/Polyamide	Polyamide	<p>Female View</p>
Coupling Nut	Nickel Copper Alloy		
Cable Jacket Material	PVC	NA	
Cable O.D.	7.4mm	NA	
Voltage Rating	125 V Max. @ 105° C		
Current Rating	4.0 Amps		
Degree of Protection	IP65 (mated)		
Operating Temperature	-25° C to 85° C		
Conductor Gauge	18 AWG	NA	
Bend Radius	74mm	NA	
Maximum Wire AWG	NA	18 AWG	
Wire Connection	NA	Screw Terminal	
PG 7 Range	NA	4 – 6mm	
PG 9 Range	NA	6 – 8mm	

M12 A-Coded Cables



M12 Straight 5 Pin Female Single Ended Cable - Shielded
TC0505MGD0000000 – 5 Meter
TC0510MGD0000000 – 10 Meter



M12 90° 5 Pin Female Single Ended Cable - Shielded
TD0505MGD0000000 – 5 Meter
TD0510MGD0000000 – 10 Meter



3 Way M12 "T"
TC0500000TT05000 – M12

M12 A-Coded Field Wireable Connectors



M12 90° 5 Pin Female Field Wireable Connector – Spring Cage
TD05F2000000071V – PG 9 Cable Gland



M12 Straight 5 Pin Female Field Wireable Connector – Spring Cage
TC05F2000000071V – PG 9 Cable Gland

Technical Data	Cable	M12 Field Wireable	"T"	Pin Out/Color Code
Molded Body/Insert	PVC/Polyamide	Nickel Plated Zinc/TPU	TPU/TPU GF	<p>Female View</p> <p>Pin 1=Shield Pin 2= V+ Pin 3= V- Pin 4= CAN_H Pin 5= CAN_L</p>
Coupling Nut	Nickel Plated Brass	Nickel Plated Brass	Nickel Plated Zinc	
Cable Jacket Material	PVC	NA	NA	
Cable O.D.	7mm	4.0 – 8mm	NA	
Voltage Rating	300 Volts	60 Volts	60 Volts	
Current Rating	4.0 Amps	4.0 Amps	4.0 Amps	
Degree of Protection	IP65 (mated)	IP 65 (mated)	IP 65 (mated)	
Operating Temperature	-40° C to 80° C	-40° C to 85° C	-25° C to 90° C	
Conductor Gauge	24 AWG (power & data)	26 – 20 AWG	NA	
Minimum Bend Radius	74mm	NA	NA	
Wire Connection	NA	Spring Cage	NA	

M12 D-Coded Cables



M12 Straight 4 Pin Male D-Coded Single Ended Cable
QA0405MT00000000 – 5 Meter
QA0410MT00000000 – 10 Meter

M12 90° 4 Pin Male D-Coded Single Ended Cable
QB0405MT00000000 – 5 Meter
QB0410MT00000000 – 10 Meter

M12 Straight 4 Pin Male D-Coded Double Ended Cable
QA0405MT0QA04000 – 5 Meter
QA0410MT0QA04000 – 10 Meter

M12 Straight 4 Pin Male D-Coded to Male RJ45 Cable
QA0405MT0VA04000 – 5 Meter
QA0410MT0VA04000 – 10 Meter

M12 Straight 4 Pin Male D-Coded to RJ45 Female Socket Converter
QA04D2MK0VC04000 – 0.2 Meter

M12 D-Coded Field Wireable Connectors



M12 90° 4 Pin Male D-Coded Field Wireable Connector w/ IDC
QB04F200R000071N – PG 9 Cable Gland – IDC

M12 Straight 4 Pin Male D-Coded Field Wireable Connector w/ IDC
QA04F200R000071N – PG 9 Cable Gland – IDC

Technical Data	Cable	M12 Field Wireable	Pin Out/Color Code
Molded Body/Insert	PVC/PE	Nickel Plated Zinc/PA 66	<p>Male View</p> <p>1 YE 2 WH 3 OG 4 BU</p>
Coupling Nut	Nickel Plated Zinc	Nickel Plated Brass	
Cable Jacket Material	PUR	NA	
Cable O.D.	6.5mm	8.0mm	
Voltage Rating (Nominal)	300 Volts	60 Volts	
Current Rating	2.0 Amps	1.75 Amps	
Degree of Protection	IP65 (mated)	IP65 (mated)	
Operating Temperature	-5° C to 50° C	-40° C to 85° C	
Conductor Gauge	22 AWG	26 – 22 AWG	
Bend Radius	46mm	NA	
Wire Connection	NA	IDC	

M12 D-Coded Cables



M12 Straight 4 Pin Male D-Coded Single Ended Cable
QA0405MK00000000 – 5 Meter
QA0410MK00000000 – 10 Meter

M12 Straight 4 Pin Male D-Coded to Male RJ45 Cable
QA0405MK0VA04000 – 5 Meter
QA0410MK0VA04000 – 10 Meter

M12 90° 4 Pin Male D-Coded Single Ended Cable
QB0405MK00000000 – 5 Meter
QB0410MK00000000 – 10 Meter

M12 Straight 4 Pin Male D-Coded to RJ45 Female Socket Converter
QA04D2MK0VCO4000 – 0.2 Meter

M12 D-Coded Field Wireable Connectors



M12 90° 4 Pin Male D-Coded Field Wireable Connector w/ IDC
QB04F200000071N – PG 9 Cable Gland – IDC

M12 Straight 4 Pin Male D-Coded Field Wireable Connector w/ IDC
QA04F200000071N – PG 9 Cable Gland – IDC

Technical Data	Cable	M12 Field Wireable	Pin Out/Color Code
Molded Body/Insert	PUR/Polyamide	Nickel Plated Zinc/PA 66	<p>Male View</p>
Coupling Nut	Nickel Plated Brass	Nickel Plated Brass	
Cable Jacket Material	PUR	NA	
Cable O.D.	5.6mm	4.0 – 8mm	
Voltage Rating (Nominal)	300 Volts	60 Volts	
Current Rating	2.0 Amps	1.75 Amps	
Degree of Protection	IP65 (mated)	IP 65 (mated)	
Operating Temperature	-40° C to 75° C	-40° C to 85° C	
Conductor Gauge	24 AWG	IDC 26 – 22 AWG	
Bend Radius	61mm	NA	
Wire Connection	NA	IDC	

M12 Class A & B Compatible Cables*



M12 Straight 5 Pin Female Single Ended Cable - Unshielded
TC0505MIE000071P – 5 Meter
TC0510MIE000071P – 10 Meter



M12 Straight 5 Pin Female to Male Double Ended Cable - Unshielded
TC0505MIETA0571P – 5 Meter
TC0510MIETA0571P – 10 Meter



M12 90° 5 Pin Female Single Ended Cable - Unshielded
TD0505MIE000071P – 5 Meter
TD0510MIE000071P – 10 Meter



M12 90° 5 Pin Female to Male Double Ended Cable - Unshielded
TD0505MIETA0571P – 5 Meter
TD0510MIETA0571P – 10 Meter

* See page 107 for M12 4 Pin cables if the selected IO-Link® Master does not accept 5 Pin cables. Maximum IO-Link® cable length is 20m.

M12 Class A & B Compatible Field Wireable Connectors*



M12 Straight 5 Pin Male Field Wireable Connector – Screw Terminal
TA05F10000000000 – PG 7 Cable Gland



M12 90° 5 Pin Male Field Wireable Connector – Screw Terminal
TB05F100000000000 – PG 7 Cable Gland

* See page 107 for M12 4 Pin field wireable connectors if the selected IO-Link® Master does not accept 5 Pin field wireable connectors. Maximum IO-Link® cable length is 20m.

Technical Data	Cable	M12 Field Wireable	Pin Out/Color Code
Molded Body/Insert	TPU	Polyamide	<p>Female View</p> <p>1 ———— BN 2 ———— WH 4 ———— BK 3 ———— BU 5 ———— GN/YE</p>
Coupling Nut	Nickel Plated Zinc	Nickel Plated Zinc	
Cable Jacket Material	PUR	NA	
Cable O.D.	5mm	Accepts 3.0 – 6.5mm	
Voltage Rating	60 Volts	125 Volts	
Current Rating	4.0 Amps	4.0 Amps	
Degree of Protection	IP65 (mated)	IP65 (mated)	
Operating Temperature	-25° C to 90° C (-13° F to 194° F)	-20° C to 100° C (-4° F to 212° F)	
Conductor Gauge	22 AWG	18 – 24 AWG	
Minimum Bend Radius	50mm	NA	
Wire Connection	NA	Screw Terminal	

M12 B-Coded (Reverse Key) Cables



M12 Straight 5 Pin Male & Female Single Ended Cables
RA0505MHP0000000 – 5 Meter – MALE
RA0510MHP0000000 – 10 Meter – MALE
RC0505MHP0000000 – 5 Meter – FEMALE
RC0510MHP0000000 – 10 Meter – FEMALE

M12 Straight 5 Pin Male – to – Female Double Ended Cables
RC0505MHPRA05000 – 5 Meter
RC0510MHPRA05000 – 10 Meter

M12 90° 5 Pin Male & Female Single Ended Cable
RB0505MHP0000000 – 5 Meter – MALE
RB0510MHP0000000 – 10 Meter – MALE
RD0505MHP0000000 – 5 Meter – FEMALE
RD0510MHP0000000 – 10 Meter – FEMALE

M12 B-Coded (Reverse Key) Field Wireable Connectors



M12 90° 5 Pin Male & Female Field Wireable Connector w/ IDC
RB05F200P000071V – PG9 Cable Gland – IDC MALE
RD05F200P000071V – PG9 Cable Gland – IDC FEMALE

M12 Straight 5 Pin Male & Female Field Wireable Connector
RA05F200P0000000 – PG7 Cable Gland – MALE
RC05F200P0000000 – PG7 Cable Gland – FEMALE

M12 Straight 5 Pin Terminating Resistor
RA05TR0000000000 – MALE

M12 Bus "T"
RA050000PRT05000

Technical Data	Cable	Field Wireable	"T"	Pin Out/Color Code
Molded Body	PUR	Nickel Plated Zinc/Brass	Aluminum	<p>Male View</p>
Insert	Polyamide	TPU/PVC	Nylon	
Coupling Nut	Nickel Plated Brass	Nickel Plated Brass/Stainless Steel	Nickel Plated Brass	
Cable Jacket Material	PVC	NA	NA	
Cable O.D.	8.5mm	4.0 – 8.0mm/3.0 – 6.5mm	NA	
Voltage Rating	300 Volts	60 Volts	250 Volts	
Current Rating	4.0 Amps	4.0 Amps	4.0 Amps	
Degree of Protection	IP65 (mated)	IP65 (mated)	IP65 (mated)	
Operating Temperature	-40° C to 80° C	-40° C to 85° C	-40° C to 80° C	
Conductor Gauge	22 AWG	26 – 20 AWG/24 – 18 AWG	NA	
Minimum Bend Radius	74mm	NA	NA	
Wire Connection	NA	IDC/Screw Terminal	NA	

M12 D-Coded Cables



M12 Straight 4 Pin Male D-Coded Single Ended Cable
QA0405MR00000000 – 5 Meter
QA0410MR00000000 – 10 Meter

M12 90° 4 Pin Male D-Coded Single Ended Cable
QB0405MR00000000 – 5 Meter
QB0410MR00000000 – 10 Meter

M12 Straight 4 Pin Male D-Coded Double Ended Cable
QA0405MR0QA04000 – 5 Meter
QA0410MR0QA04000 – 10 Meter

M12 Straight 4 Pin Male D-Coded to Male RJ45 Cable
QA0405MR0VA04000 – 5 Meter
QA0410MR0VA04000 – 10 Meter

M12 Straight 4 Pin Male D-Coded to RJ45 Female Socket Converter
QA04D2MK0VC04000 – 0.2 Meter

M12 D-Coded Field Wireable Connectors



M12 90° 4 Pin Male D-Coded Field Wireable Connector w/ IDC
QB04F200R000071N – PG 9 Cable Gland – IDC

M12 Straight 4 Pin Male D-Coded Field Wireable Connector w/ IDC
QA04F200R000071N – PG 9 Cable Gland – IDC

Technical Data	Cable	M12 Field Wireable	Pin Out/Color Code
Molded Body/Insert	PUR/PUR or PE	Nickel Plated Zinc/PA 66	<p>Male View</p> <p>1 — YE 2 — WH 3 — OG 4 — BU</p>
Coupling Nut	Nickel Plated Zinc and Brass	Nickel Plated Brass	
Cable Jacket Material	PVC	NA	
Cable O.D.	6.5mm/74mm	4.0 – 8.0mm	
Voltage Rating (Nominal)	42 Volts	60 Volts	
Current Rating	1.5 Amps	1.75 Amps	
Degree of Protection	IP65 (mated)	IP65 (mated)	
Operating Temperature	-25° C to 60°	-40° C to 85° C	
Conductor Gauge	24 & 22 AWG	26 – 22 AWG	
Bend Radius	19.5mm	NA	
Wire Connection	NA	IDC	



Global Contacts

Australia	(61) 2-9-451-7077	France	(33) 2-37-24-42-24	Netherlands	(31) 33-277-7911
Brazil	(55) 11-4208-1700	Germany	(49) 7237-9960	Singapore	(65) 6556-1100
Canada	(1) 519-758-2700	India	(91) 44-39197300	South Korea	(82) 2-3483-1570
China	(86) 21-3395-0000	Italy	(39) 02-356931	Spain	(34) 942-87-6100
Czech Republic	(420) 235-090-061	Japan	(81) 798-65-6361	United Kingdom	(44) 1695-713600
Dubai - UAE	(971) 4 811 8200	Mexico	(52) 55-5809-5640		