



G118-0002

ULTRA SLIMPAK® G118-0002

DC Powered RTD Input Limit Alarm

Provides Relay Contact Closures
at a Preset RTD/Resistance Input Level



- Programmable HI or LO, Failsafe or Non-failsafe
- Field Configurable Ranges for Platinum, Nickel and Copper RTDs
- Ultra Slim Housing for High Density Installations

- LED Trip and Input Indicators
- Flexible Power Supply Accepts 9 to 30 VDC
- ASIC Technology for Enhanced Reliability
- RoHS Compliant

Description

The Ultra SlimPak G118 is a DIN rail mount, RTD input limit alarm with dual setpoints and two contact closure outputs. The field configurable input and alarm functions offer flexible setpoint capability. There are up to eight temperature ranges available for each RTD type to ensure accuracy and maximize setpoint resolution.

The G118 is configurable as a single or dual setpoint alarm, with HI or LO trips and failsafe or non-failsafe operation. Also included are adjustable deadbands (0.25 to 5% of full scale input) for each setpoint and a flexible DC power supply which accepts any voltage between 9 and 30VDC.

Diagnostic LEDs

The G118 is equipped with three front panel LEDs. The dual function green LED is labeled INPUT and indicates line power and input signal status. Active DC power is indicated by an illuminated LED. If this LED is off, check DC power and the wiring connection. If the input signal is more than 110% of the full scale range, the LED will flash at 8 Hz. Below 0%, it flashes at 4 Hz. Two red LEDs indicate the relay state for each setpoint. An illuminated red LED indicates the tripped condition.

Output

The G118 is equipped with two SPDT (form C) relays, rated at 120VAC or 28VDC at 5 Amperes. Each of these relays is independently controlled by the field configurable setpoint and deadband.

Operation

The field configurable G118 limit alarm setpoints can be configured for HI or LO, failsafe or non-failsafe operation. Each of the setpoints has a respective HI or LO deadband. In a tripped condition, the setpoint is exceeded and the appropriate red LED will illuminate. The trip will reset only when the process falls below the HI deadband or rises above the LO deadband (see Figure 1). For proper deadband operation the HI setpoint must always be set above the LO setpoint. In failsafe operation, the relay is energized when the process is below the HI setpoint or above the LO setpoint (opposite for non-failsafe). In the failsafe mode, a power failure results in an alarm state output.

Dynamic Deadband

Circuitry in the G118 prevents false trips by repeatedly sampling the input. The input must remain beyond the setpoint for 100 milliseconds, uninterrupted, to qualify as a valid trip condition. Likewise, the input must fall outside the deadband and remain there for 100 milliseconds to return the alarm to an untripped condition. This results in a “dynamic deadband” (based on time) in addition to the normal deadband.

Configuration

Unless otherwise specified, the factory presets the Model G118 as follows:

- Input: Platinum (100 Ohm)
- Range: 0 to 250°C
- Output: Dual, SPDT
- Trip: A:HI, B:LO
- Failsafe: No
- Deadband: A, B: 1.0%

The DC power input accepts any DC source between 9 and 30V; typically a 12V or 24VDC source is used (see Accessories).

For other I/O ranges, refer to Tables 1 through 3 and reconfigure switches SW1 and SW2 for the desired input type, range and function.

WARNING: Do not change switch settings with power applied. Severe damage will result!

1. With DC power off, position input switches 1 through 6 on “SW2” for RTD type (Table 1).
2. Set position 1 through 4 of input range switch “SW1” for the desired RTD type and input temperature range (Table 3).
3. Set position 5 and 6 of input range switch “SW1” to ON for a HI trip setpoint or OFF for a LO trip setpoint (Figure 4).
4. Set position 7 of input range switch “SW1” to ON for non-failsafe operation or OFF for failsafe operation (e.g. alarm trips upon power failure).

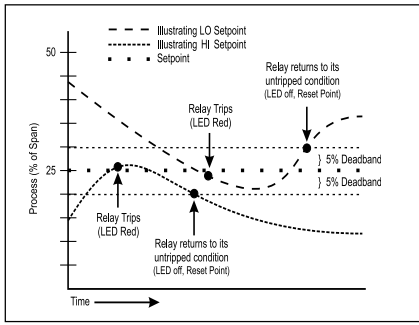

Figure 1: Limit alarm operation and effect of deadband.

Calibration

1. After configuring the DIP switches, connect the input to a calibrated RTD source or a resistance decade box and apply power.

Note: To maximize thermal stability, final calibration should be performed in the operating installation, allowing approximately 1 to 2 hours for warm up and thermal equilibrium of the system.

2. Setpoint Calibration: Before adjusting the setpoint, adjust the deadband pot to its minimum (fully counterclockwise). With the desired trip RTD resistance input applied, adjust the setpoint pot until the relay trips. For HI trip calibration, start with the setpoint pot above the desired trip (fully clockwise). For LO trip calibration, start with the setpoint pot below the desired trip (fully counterclockwise).

3. Deadband Calibration: Set the deadband pot to its minimum (fully counterclockwise). Adjust the setpoint pot to the desired trip. Adjust the RTD resistance input until the relay trips. Readjust the deadband pots to 5% (fully clockwise). Set th RTD resistance input to the desired deadband position. Slowly adjust deadband (counterclockwise) until the relay untrips.

Table 1: G118 RTD Type Settings

RTD Type	Selector SW2					
	1	2	3	4	5	6
Cu 10	■				■	■
Pt 100, Cu 100				■		
Pt 500, NiFe 604		■	■			
Pt 1000		■				
Ni 120				■		

Key: ■ = 1 = ON or Closed

Table 2: G118 Trip Settings

Function	Selector SW1		
	5	6	7
Trip B HI	■		
Trip A HI		■	
Non-Failsafe			■

Key: ■ = 1 = ON or Closed

Relay Protection & EMI Suppression

When switching inductive loads, maximum relay life and transient EMI suppression is achieved using external protection (see Figures 2 and 3). Place all protection devices directly across the load and minimize all lead lengths. For AC inductive loads, place a properly rated MOV across the load in parallel with a series RC snubber. Use a 0.01 to 0.1uF pulse film capacitor (foil polypropylene recommended) of sufficient voltage, and a 47 ohm, 1/2W carbon resistor. For DC inductive loads, place a diode across the load (PRV > DC supply, 1N4006 recommended) with (+) to cathode and (-) to anode (the RC snubber is an optional enhancement).

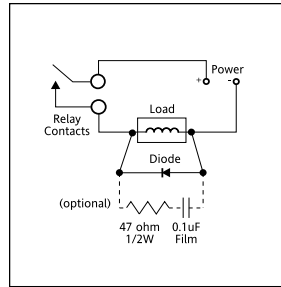

Figure 2: DC Inductive Loads

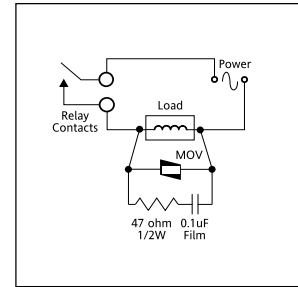

Figure 3: AC Inductive Loads

Table 3: G118 Range Settings

RTD Input Range	Selector SW1				Resistance (Ohms)
	1	2	3	4	
Pt100, 500, 1000 (alpha = 0.00385)					
0 to 50 _i C (32 to 122 _i F)	■	■	■	■	*Pt100 100 to 119.4
-50 to 50 _i C (-58 to 122 _i F)	■	■			
0 to 100 _i C (32 to 212 _i F)			■	■	100 to 138.5
-100 to 100 _i C (-148 to 212 _i F)			■		60.2 to 138.5
0 to 250 _i C (32 to 482 _i F)	■	■	■		100 to 194.1
-200 to 250 _i C (-328 to 482 _i F)	■	■	■		18.5 to 194.1
0 to 550 _i C (32 to 1022 _i F)	■	■	■		100 to 297.4
0 to 850 _i C (32 to 1562 _i F)	■	■	■		100 to 390.3
Cu10					
25 to 70 _i C (77 to 158 _i F)	■	■	■		Cu10 10.0 to 11.74
-30 to 70 _i C (-22 to 158 _i F)	■	■			7.876 to 11.74
25 to 120 _i C (77 to 248 _i F)			■	■	10.0 to 13.67
-70 to 120 _i C (-94 to 248 _i F)			■		6.318 to 13.67
25 to 260 _i C (77 to 500 _i F)	■	■	■		10.0 to 19.116
-200 to 260 _i C (-328 to 500 _i F)	■	■	■		1.058 to 19.116
Cu100					
25 to 75 _i C (77 to 167 _i F)	■	■	■		Cu100 100 to 115.5
-25 to 75 _i C (-13 to 167 _i F)	■	■	■		80.7 to 115.5
25 to 150 _i C (77 to 302 _i F)	■		■		100 to 148.3
-100 to 150 _i C (-148 to 302 _i F)	■		■		51.3 to 148.3
25 to 260 _i C (77 to 500 _i F)	■	■	■		100 to 191.2
-200 to 260 _i C (-328 to 500 _i F)	■	■	■		10.6 to 191.2
Ni120					
-30 to 30 _i C (-22 to 86 _i F)	■	■	■		Ni120 99.4 to 142.1
-80 to 30 _i C (-112 to 86 _i F)		■	■		66.6 to 142.1
-30 to 100 _i C (-22 to 212 _i F)	■	■	■		99.4 to 200.6
-30 to 200 _i C (-22 to 392 _i F)	■	■	■		99.4 to 303.5
-30 to 320 _i C (-22 to 608 _i F)	■	■	■		99.4 to 471.2
NiFe604					
-40 to 0 _i C (-40 to 32 _i F)	■	■	■		NiFe604 499.1 to 604.0
-40 to 50 _i C (-40 to 122 _i F)	■	■	■		499.1 to 751.8
-200 to 50 _i C (-328 to 122 _i F)	■	■			245.3 to 751.8
-200 to 100 _i C (-328 to 212 _i F)	■	■			245.3 to 917.3
-200 to 240 _i C (-328 to 464 _i F)	■	■			245.3 to 1475.6

Key: ■ = 1 = ON or Closed

*Resistance values for Pt500 and Pt1000 are 5 and 10 times the resistance

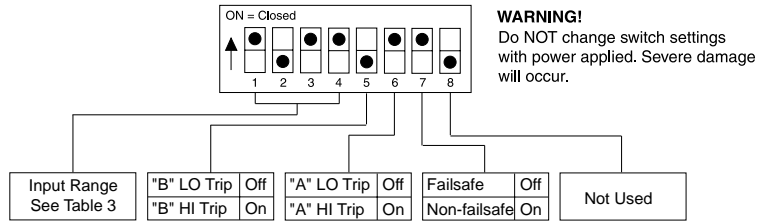

Figure 4: G118 Input Range/Function Selection (SW1) Factory Default Settings

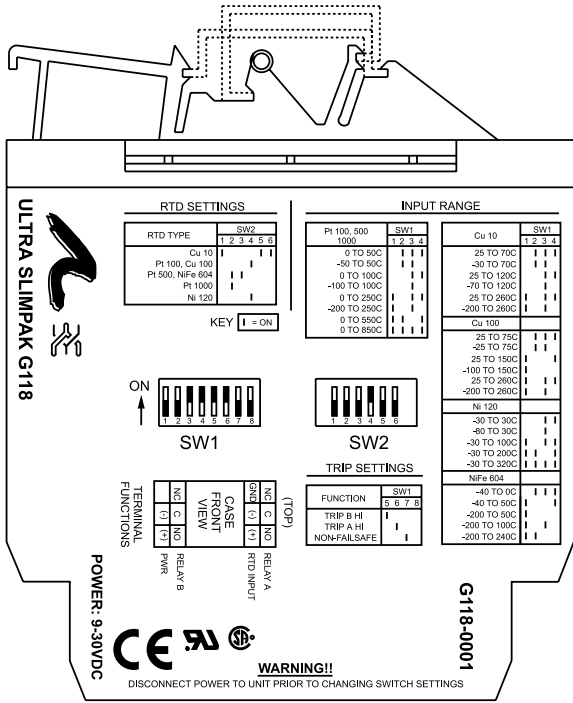

Figure 5: G118 Factory Cal; 0-250°C (Pt 100), A-HI/B-LO, Non-Failsafe

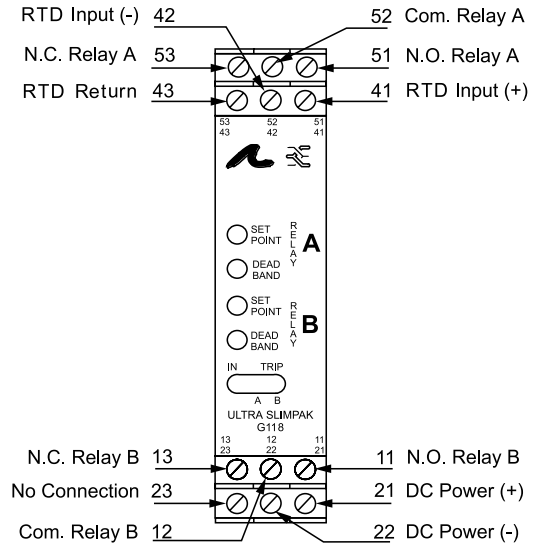

Figure 6: Terminal Wiring Diagram for G118

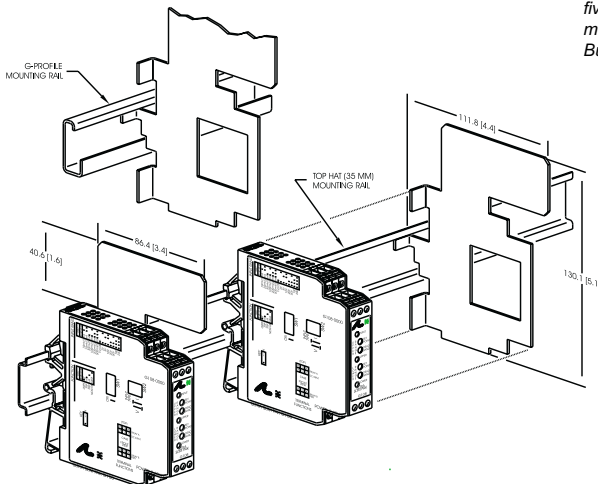

Figure 7: Mounting Multiple Modules

Note: All Ultra SlimPak modules are designed to operate in ambient temperatures from 0 to 55°C when mounted on a horizontal DIN rail. If five or more modules are mounted on a vertical rail, circulating air model HS01 Heat Sink is recommended. Refer to HS01 Technical Bulletin (#721-0549-00) or contact the factory for assistance.

Specifications

Inputs

Sensors:
Pt100, Pt500, Pt1000 (0.00385Ohms/Ohm/°C);
Cu10, Cu100; Ni120, NiFe604
Sensor Connection: 3-wire.
Input Ranges: See table 1.

Excitation Current (Max)

<2mA for Pt100, Pt500, Pt1000, Ni120,
Cu100 or NiFe604
<10mA for Cu10

Leadwire Resistance

40% of base sensor resistance or 100 Ohms
(whichever is less), maximum per lead.

Leadwire Effect

Less than 1% of selected span over entire
leadwire resistance range.

Input Protection

Normal Mode: Withstands ±5VDC.
Common Mode (Input to Gnd): 1800VDC, max.

LED Indicators

Input Range (Green):
>110% input: 8Hz flash;
>-10% input: 4Hz flash
Setpoint (Red):
Tripped: Solid red;
Safe: Off

Limit Differentials (Deadbands)

0.25% to 5% of span

Response Time

Dynamic Deadband:
Relay status will change when proper
setpoint/ process condition exists for
100msec.
Normal Mode (analog filtering):
<250mSec, (10-90%)

Setpoints

Effectivity:
Setpoints are adjustable over 100% of
the selected input span
Repeatability (constant temp.):
±0.2% of full scale

Stability

Line Voltage: ±0.01%/%, max.
Temperature: ±0.05% of full scale/°C, max.

Common Mode Rejection

DC to 60Hz: 120dB
>60Hz: 100dB

Isolation

1800VDC between contacts, input & power

EMC Compliance (CE Mark)

EMC: EN61326-1:2013
Safety: EN61010-2:2013

Humidity (Non-Condensing)

Operating: 15 to 95% @45°C
Soak: 90% for 24 hours @65°C

Temperature Range

Operating: -15 to 55°C (5 to 131°F)
Storage: -25 to 75°C (-13 to 158°F)

Power

Consumption: 1.5W typical, 2.5W max.
Supply Range: 9 to 30VDC, inverter isolated

Relay Contacts

2 SPDT (2 form C) Relays, 1 Relay per
setpoint
Current Rating (resistive)
120VAC: 5A; 240VAC: 2A; 28VDC: 5A
Material: Gold flash over silver alloy
Electrical Life: 10⁵ operations at rated load
*Note: External relay protection is required
for use with inductive loads (see Figures 2 & 3).*
Mechanical Life: 10⁷ operations

Weight

0.56lbs.

Agency Approvals

CSA certified per standard C22.2, No. 0-M91
and 142-M1987 (File No. LR42272)
UL recognized per standard UL508
(File No.E99775)
CE Conformance per EMC directive 2004/
108/EC and Low Voltage directive 2006/
95/EC.
RoHS Compliant

Ordering Information

Models & Accessories

Specify:

1. Model: **G118-0002**
2. Accessories: (see Accessories)
3. Optional Custom Factory Calibration; specify **C620** with desired input and output range.

Accessories

SlimPak "G" series modules will mount on standard TS32 (model MD02) or TS35 (model MD03) DIN rail. In addition, the following accessories are available:

HS01	Heat Sink
MD03	TS35 x 7.5 DIN Rail
WV905	24VDC Power Supply (0.5 Amp)
H910	24VDC Power Supply (1Amp)
H915	24VDC Power Supply (2.3 Amp)
MB03	End Bracket for MD03
C664	I/O Descriptive Tags

Dimensions

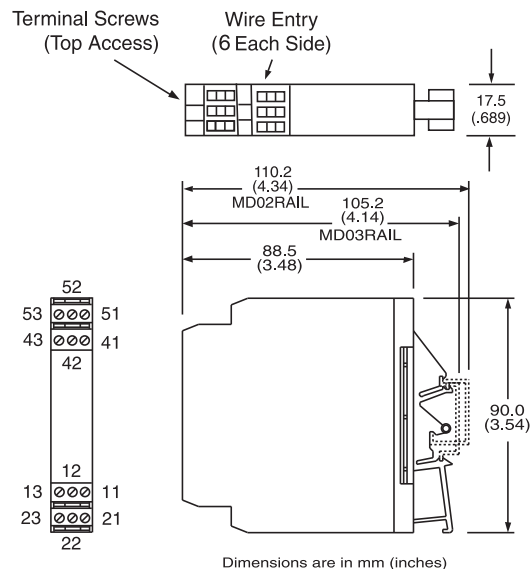

Eurotherm.

by Schneider Electric

Schneider Electric Systems USA, Inc.

44621 Guilford Drive, Suite 100

Ashburn, VA 20147

703-724-7300

info@eurotherm.com or www.eurotherm.com/actionio

Factory Assistance

For additional information on calibration, operation and installation contact our Technical Services Group:

703-724-7314

actionsupport@eurotherm.com

721-0651-00-H 09/06 Copyright© Eurotherm, Inc 2006