



FLOWSIC150 Carflow

EXHAUST GAS VOLUME FLOW MEASUREMENT FOR VEHICLE AND ENGINE TEST BENCHES UP TO 600 °C

Ultrasonic gas flow measuring instruments

SICK
Sensor Intelligence.

EXHAUST GAS VOLUME FLOW MEASUREMENT IN REAL TIME WITH THE FLOWSIC150 CARFLOW

The identification of pollutants in combustion exhaust gases from engines is an important part of the acquisition of an operating license for a vehicle. Pollutant emissions can be continuously measured and limit values upheld through the use of reliable emission flow measurement technology. This creates high demands on the measurement technology. In addition to reliability and accuracy, the resistance to temperature and absence of feedback play important roles. With the FLOWSIC150 Carflow gas flow measuring instrument from SICK, pollutant emissions can be identified directly in undiluted exhaust gas and without influencing the engine characteristics. Furthermore, the real time measurement of the exhaust gas makes it possible to optimize the performance of combustion engines. The FLOWSIC150 Carflow was developed together with leading automobile manufacturers and unites the advantages of modern ultrasonic technology with an innovative sensor solution. The measurement technology is based on more than 30 years of experience in ultrasonic technology at SICK and boasts above-average performance.



Real time exhaust gas measurement

Flow measurement is done directly and without feedback in undiluted exhaust gas. Changing gas compositions do not have an influence on the measurement result of the ultrasonic measurement. The measured values can be calculated with the results of a real time gas analysis and the time curve of the pollutant quantities can be identified. Representative pollutant emissions corresponding to the bag results from CVS systems on chassis dynamometers result from the accumulation of the measured values.

This process can be applied on engine test benches to determine discrete pollutant curves, therefore creating a valuable base of data for the development and optimization of engines.

High-precision multi-path measurement

Measurement is done in parallel on four measurement paths, and the individual measured values are weighted and used in the device-internal calculation. The FLOWSIC150 Carflow delivers precise measurement results even if the flow profiles are faulty, which can be caused by flow from the exhaust pipe which is not always ideal.

Each individual device is calibrated on a certified SICK test bench in accordance with Measuring Instruments Directive 2004/22 / EC, or calibrated for individual installation conditions on request.

Advanced diagnostics

An automated control cycle checks the device function periodically, while the integrated self-diagnosis continuously monitors all important function parameters. In the event of impermissible deviations that could affect the measurement result, a warning message is generated so that maintenance can be planned in time. This allows component wear to be detected early on. It also allows functional impairment or failure of the measurement function to be prevented.

Integrated volume flow measurement

The FLOWSIC150 Carflow features a function for automated standardization of the exhaust gas volume flow. A pressure and temperature measurement system is therefore integrated in the device.

The temperature is measured directly in the measurement cell with two temperature sensors offset in the flow cross-section. This reduces the influence of temperature stratification and increases the measurement accuracy.

Using the exhaust gas volume flow corrected to standard conditions, the emission densities known under standard conditions are used to calculate mass-related emissions.

High measurement accuracy and modern signal evaluation

To reliably capture the dynamics of the exhaust flow and to achieve very high measurement accuracy under all conditions, 50 time-of-flight measurements are taken per second on each of the 4 measuring paths. This guarantees a solid base of data for signal evaluation without extending the response time of the device. The individual ultrasonic signals are sampled by the electronics in the MHz range, where a reliable transit time determination is achieved in the ± 5 ns range. This accuracy is particularly critical in the range of low flow velocities, e.g. when idling the engine, because the physical measuring effect is very small here. In addition, the adaptive path compensation prevents faulty measurements on individual paths in the event of dynamic flow conditions and also ensures interruption-free measurement even with strongly pulsating exhaust gas.

Mobile design

The FLOWSIC150 Carflow is available as a mobile dynamometer wagon in a compact design and is ideally suited to flexible exhaust gas flow measurement on exhaust gas and chassis dynamometer test benches.

Different process connections are available for device connection. The integrated function enables individual adjustment of the connection height of the exhaust gas line in the inflow and outflow.

PRODUCT OVERVIEW

The FLOWSIC150 Carflow is available in two different versions, which differ when it comes to the process connection and measuring range.



FLWSIC150 Carflow version for 2.5 inch connection

- Measuring range 0 to 180 l/s (0 to 650 m³/h)
- Suitable for exhaust gas temperatures up to 600 °C
- Process connection possible via various connections: Kamlok coupling, Marman flange, E-Line flange, Tri-Clamp or process flange



FLWSIC150 Carflow version for 4 inch connection

- Measuring range 0 to 500 l/s (0 to 1,800 m³/h)
- Suitable for exhaust gas temperatures up to 600 °C
- Process connection possible via various connections: Kamlok coupling, Marman flange, E-Line flange, Tri-Clamp or process flange

SOPAS ET configuration software

The SOPAS ET software is the operating program for the FLOWSIC150 Carflow measurement system and stands for

SICK
Open
Portal for
Applications and
Systems

The program is a standard user interface for different SICK device solutions devices from the field of emission measurement technology (e.g. for volume flow measurement, dust measurement, gas analysis). This uniform basis permits comprehensive support for all implemented technologies, for both old and new devices.

SOPAS ET offers:

- Quick and easy connection setup to the device
- Parameterization, configuration and diagnostics for the FLOWSIC150 Carflow
- Download and upload of configuration files and parameter sets
- Simple project and device handling
- Communication via various fieldbuses
- Firmware updates

LEADING ULTRASONIC TECHNOLOGY FOR DEMANDING EXHAUST MEASUREMENT

Integrated thermal and exhaust gas conditioning depending on the flow situation

The FLOWSIC150 Carflow works with an innovative exhaust gas flow conditioning process to optimize the properties of the measurement technology. This compensates for faults in the flow range of the measurement, thereby increasing measurement accuracy. Based on experience, ideal inlet conditions are often difficult to achieve when installing the measuring instrument due to the confined spaces. In addition, variable flow pattern controls lead to different flow profiles. From the user's perspective, the immunity of the device to flow perturbation is therefore of great importance, as this means that the flow speed can be measured regardless of the specific flow conditions. Copper plates in the preheating section of the device cause flow rectification due to their location and support the occurrence of a flow profile that is as rotationally symmetrical as possible, with minimum pressure loss. They are welded to the heated pipe wall, whereby heat transfer is optimized for the inflowing exhaust gas. To keep the temperature gradients between the pipe wall and exhaust gas as small as possible and to prevent condensation, the entire measuring distance of the device is heated throughout. This solution ensures uniform temperature control of the exhaust gas over the entire pipe cross-section, with the result that the temperature measurement and subsequent normalization of the volume flow are carried out with very high accuracy.



Flow rectifier with star-shaped copper plates (shown in brown)

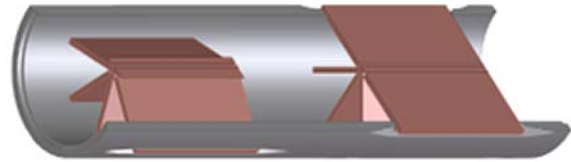

Flow rectifier cut open

Innovative multi-path sensor design with internal cooling for use in exhaust gas temperatures of up to 600 °C

Exhaust gas volume flow measurement with the FLOWSIC150 Carflow is done in parallel on several measuring paths, therefore covering a large part of the flow profile.

The ultrasonic sensors used in the FLOWSIC150 Carflow work with an innovative, patented cooling system which enables permanent application of the device at exhaust gas temperatures of up to 600 °C. The cooling air supply is integrated into the device; cooling air cannot penetrate into the measuring medium. An emergency voltage supply maintains the cooling system in the event of power failure to protect the sensors from overheating.

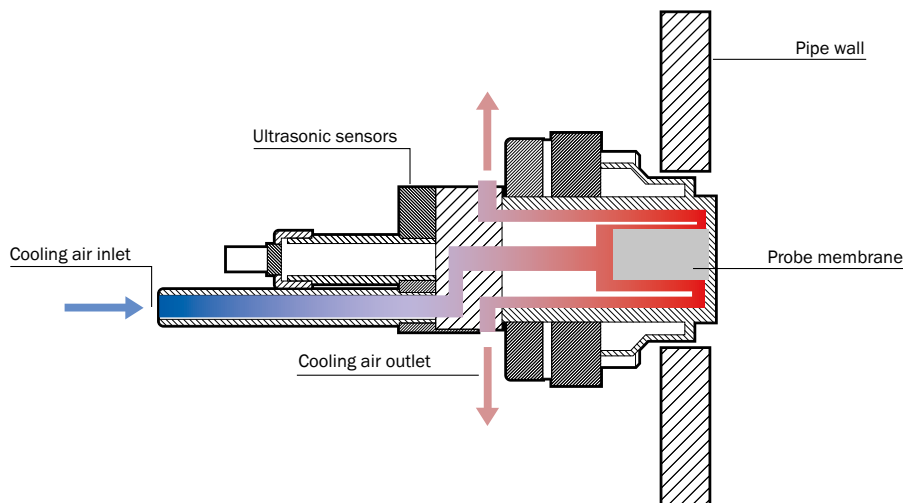

Schematic diagram of sensor cooling

SERVICE AND ACCESSORIES

Factory calibration

In order to achieve the best possible measurement accuracy, each individual device is flow-calibrated by the manufacturer. To achieve this, the manufacturer uses a certified test bench in accordance with Measuring Instruments Directive 2004/22 / EC. Calibration is done on the basis of the Reynolds number. For this purpose, the FLOWSIC150 Carflow is installed in the test bench in series connection to a calibrated ultrasonic gas flow meter with eight measuring paths. By testing, the remaining variance of the values from the measuring instrument and reference counter is determined as an error curve and recorded above the Reynolds number. Subsequently, a correction of the deviation is made by a suitable polynomial, whose coefficients can be configured as parameters in the measuring instrument. The correction factor multiplied by the measured area velocity results in the corrected gas velocity value.



FLWSIC150 Carflow factory calibration

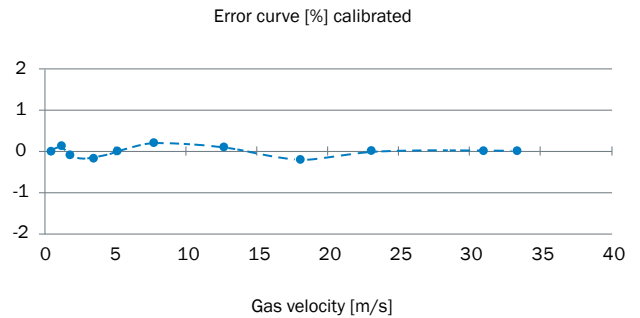

Calibration curve and zero point stability

Flexible process connections

FLWSIC150 Carflow can be connected to the exhaust gas lines of the vehicle or engine test bench via various connection elements. The following connections are available:

- Kamlok quick coupling
- Marman flange
- E-Line flange
- Tri-Clamp
- Process flange according to DIN EN 1092-1 or ANSI B15.5

Heatable measurement gas lines can be connected and controlled by the device to minimize the condensation effects in the inflow and outflow area. The FLOWSIC150 Carflow is equipped with two additional heating controllers for this reason.



FLWSIC150 Carflow: Connection example

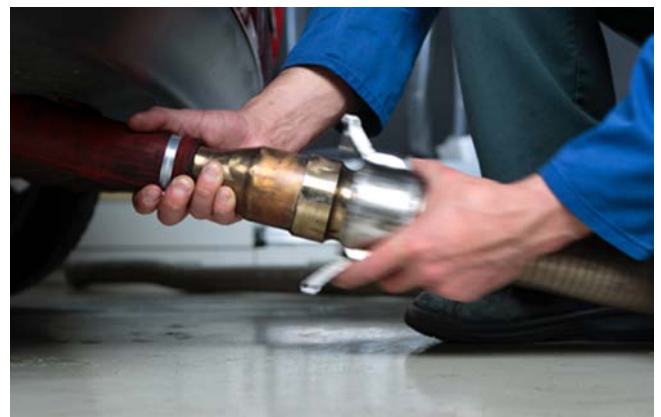

Example for connection to test vehicle

Connection with male thread
(2.5" or 4")

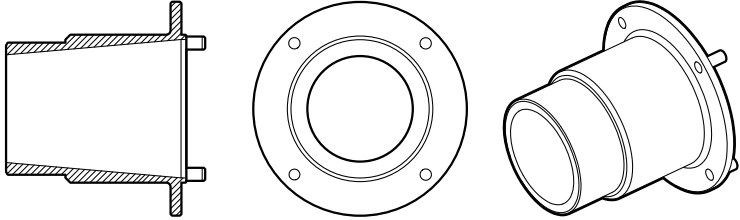

Kamlok (2.5" or 4")

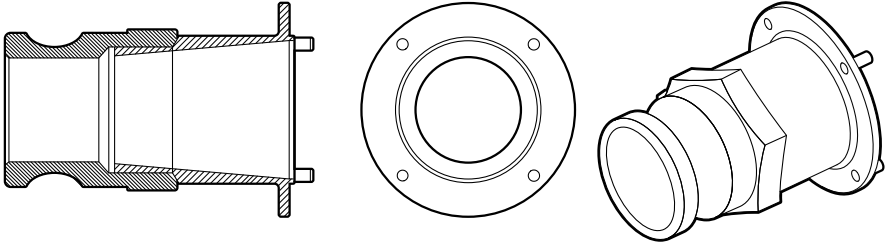

Marman (2.5" or 4")

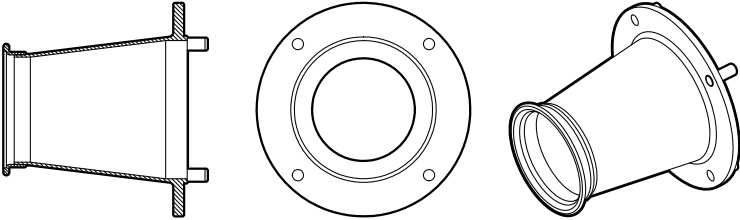

E-Line (2.5" or 4")

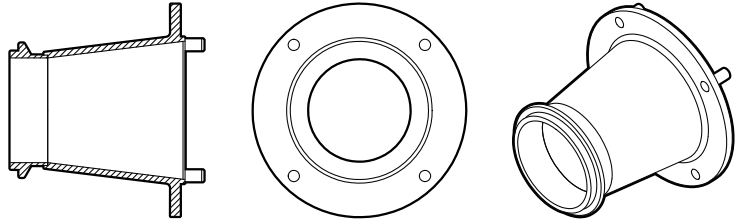

Tri-Clamp (2.5" or 4")

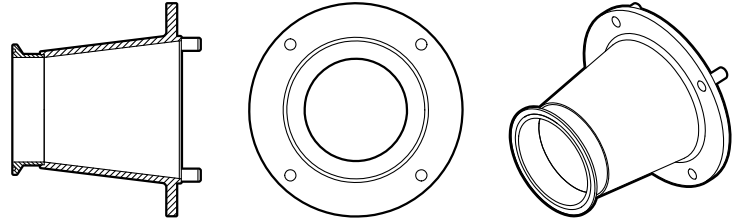

Process flange

- DIN EN 1092-1 (DN65 or DN100)
- ANSI B16.5#150 (4")

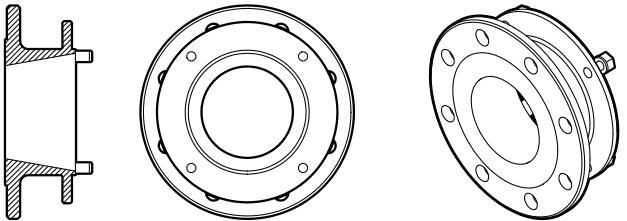

EXHAUST GAS VOLUME FLOW MEASUREMENT FOR VEHICLE AND ENGINE TEST BENCHES UP TO 600 °C

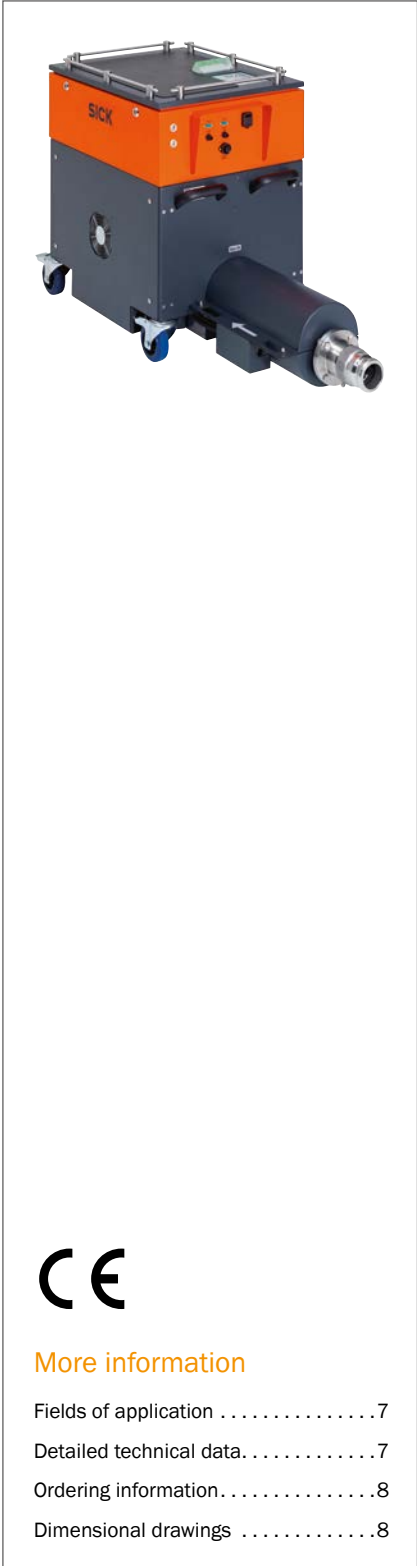

Product description

The FLOWSIC150 Carflow offers first-class performance in combination with a compact design. The combination of modern sensor technology and powerful electronics enables exceptional measurement accuracy at exhaust gas temperatures up to 600. The ultrasonic measurement principle does not generate any pressure loss, has no moving parts, and does not depend on

pressure, temperature and gas composition, therefore enabling reliable and maintenance-free operation. Due to the direct measurement of the undiluted exhaust gas, the FLOWSIC150 Carflow is easy to install, largely non-reactive, and ideally suited for flexible exhaust gas measurement on vehicle and engine test benches.

At a glance

- Real time ultrasonic exhaust gas flow measurement
- Independent of pressure, temperature and gas composition
- Excellent measurement accuracy
- Use at exhaust gas temperatures up to 600 °C
- Direct measurement in undiluted exhaust gas
- Heated measuring distance
- Minimal exhaust gas back pressure
- Small storage space, mobile, flexible

Your benefits

- High measured data quality thanks to high measurement accuracy
- Reliable flow measurement even under minimal flow and during idling
- Reliable operation thanks to high exhaust gas temperature design
- Versatile concept – ideal for use on existing test benches
- Low cost of investment thanks to mobile application with various test benches
- Convenient installation without feedback on engine characteristics and exhaust gas analysis systems
- Extended operating time through patented sensor cooling
- Low operating costs thanks to minimal maintenance requirements



More information

Fields of application7
 Detailed technical data7
 Ordering information8
 Dimensional drawings8

→ www.sick.com/FLWSIC150 Carflow

For more information, simply visit the above link to obtain direct access to technical data, CAD design models, operating instructions, software, application examples, and much more.



Fields of application

- Exhaust gas flow measurement in automotive industry research and development
- Real-time exhaust gas flow measurement for vehicle and engine test benches
- Determination of modal emissions characteristics in combination with standard exhaust gas analyzers
- Proportional regulation of sampling in a bag-mini-diluter (BMD) emissions measurement system

Detailed technical data

The precise device specifications and product performance data may vary and are dependent on the respective application and customer specifications.

FLAWSIC150 Carflow system

Measurands	Gas velocity, operational volume flow, volume flow s.c., gas temperature, gas pressure, speed of sound
Number of measuring paths	4
Measurement principle	Ultrasonic transit time difference measurement
Measuring ranges	Operational volume flow (2.5" connection) 0 l/s ... + 180 l/s / 0 m ³ /h ... 650 m ³ /h Operational volume flow (4" connection) 0 l/s ... + 500 l/s / 0 m ³ /h ... 1,800 m ³ /h Gas pressure 700 hPa ... + 1,300 hPa
Accuracy	± 0.5% ¹⁾ of the measured value (in the range of 0.05 Q _{max} ... Q _{max})
Diagnostic functions	Self-test and fault diagnosis
Gas temperature	≤ +600 °C
Operating pressure	700 hPa ... 1,300 hPa
Ambient temperature	-10 °C ... +40 °C
Ambient pressure	Atmospheric
Ambient humidity	5% ... 95% relative humidity
Electrical safety	CE
Analog outputs	2 outputs: 0/2/4 ... 20 mA, 750 Ω For standard volume flow and absolute pressure, freely scalable
Interfaces	Ethernet (virtual COM port) RS-232 (AK protocol) USB (service interface)
Bus protocol	AK protocol
Display	4-line LC display Status LEDs: "Operational", "Maintenance" and "Fault"
Operation	Via LC display or SOPAS ET software
Performed by	2.5" version 4" version
Dimensions (W x H x D)	495 mm x 715 mm x 1,060 mm (2.5" version) 495 mm x 715 mm x 1,180 mm (4" version)
Weight	Connection 2.5" ≤ 95 kg Connection 4" ≤ 140 kg
Mounting	Optional connection pieces: - Male thread type G in accordance with ISO 228/1 (e.g. for Kamlok quick-release coupling) - E-Line, Marman, Tri-Clamp, Kamlok quick-release couplings - Flange DIN EN 1092-1 or ANSI B16.5

Electrical connection	Voltage	90 V AC ... 125 V AC / 190 V AC ... 250 V AC
	Frequency	50 Hz / 60 Hz
	Power consumption	Without external heat line: $\leq 1,700$ W Max. permissible output of external heating lines at 190 ... 250 V AC: $\leq 1,600$ W Max. permissible output of external heating lines at 90 ... 125 V AC: $\leq 1,000$ W
Integrated components	Integrated pressure and temperature measurement	
Optional measurement gas line	Nominal width 2.5" and 4" heated, with temperature sensor Pt100 Nominal width 2.5" and 4", not heated	

¹⁾ For fully developed flow profiles

Ordering information

Our regional sales organization will be glad to advise you on which device configuration is best for you.

Dimensional drawings (dimensions in mm)

FLAWSIC150 Carflow

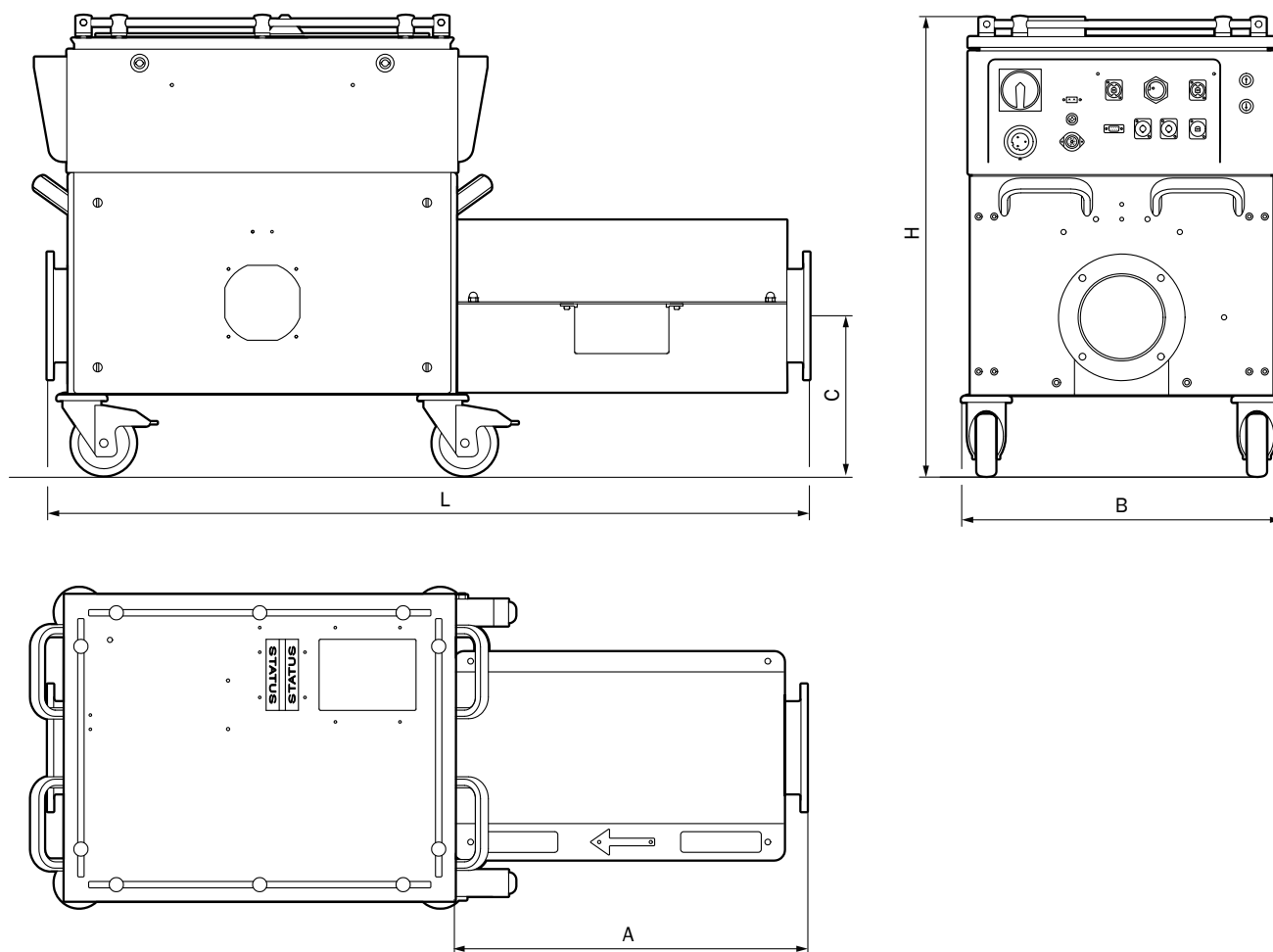

FLAWSIC150 Carflow	A	B	C	L	H
2.5 inch	425	495	130	1,060	715
4.0 inch	550	495	250	1,180	715

REGISTER NOW AT WWW.SICK.COM AND ENJOY THE FOLLOWING BENEFITS





- ✔ View net price and individual discount for each product.
- ✔ Simple ordering and delivery tracking.
- ✔ Overview of all quotes and orders.
- ✔ Create, save and share personalized wish lists.
- ✔ Direct ordering: place large orders quickly.
- ✔ View status of all quotes and orders. Notification by e-mail in the event of status changes.
- ✔ Simple reuse of previous orders.
- ✔ Convenient export of quotes and orders in the right format for your systems.



SERVICES FOR MACHINES AND SYSTEMS: SICK LifeTime Services

The sophisticated and versatile LifeTime Services perfectly complement SICK’s comprehensive product range. Services range from product-independent consulting to traditional product services.



- 
Consulting and design
 Secure and professional
- 
Product and system support
 Reliable, fast, and on-site
- 
Verification and optimization
 Safe and regularly tested
- 
Upgrade and retrofits
 Simple, safe, and economical
- 
Training and education
 Practical, focused, and professional

SICK AT A GLANCE

SICK is a leading manufacturer of intelligent sensors and sensor solutions for industrial applications. With more than 9,700 employees and over 50 subsidiaries and equity investments as well as numerous agencies worldwide, SICK is always close to its customers. A unique range of products and services creates the perfect basis for controlling processes securely and efficiently, protecting individuals from accidents, and preventing damage to the environment.

SICK has extensive experience in various industries and understands their processes and requirements. With intelligent sensors, SICK delivers exactly what the customers need. In application centers in Europe, Asia, and North America, system solutions are tested and optimized in accordance with customer specifications. All this makes SICK a reliable supplier and development partner.

Comprehensive services round out the offering: SICK LifeTime Services provide support throughout the machine life cycle and ensure safety and productivity.

That is “Sensor Intelligence.”

Worldwide presence:

Australia, Austria, Belgium, Brazil, Canada, Chile, China, Czech Republic, Denmark, Finland, France, Germany, Great Britain, Hungary, Hong Kong, India, Israel, Italy, Japan, Malaysia, Mexico, Netherlands, New Zealand, Norway, Poland, Romania, Russia, Singapore, Slovakia, Slovenia, South Africa, South Korea, Spain, Sweden, Switzerland, Taiwan, Thailand, Turkey, United Arab Emirates, USA, Vietnam.

Detailed addresses and further locations → www.sick.com