

Features

- Rugged design, built to withstand steam, superheated water, and corrosive fluids
- Available in normally closed and normally open constructions
- High-performance, maintenance-free stuffing box that is resistant to thermal shock
- Anti-water hammer design
- Pressure can be applied to any port as needed by the process
- Visual position indicator standard
- Ideal for use on tire presses and industrial autoclaves

Construction

Operator: Nickel plated aluminum

Valve Parts in Contact with Fluids	
Valve body and plug	304 Stainless Steel
Stuffing box housing	304 Stainless Steel
Stem	316L Stainless Steel
Disc	304 Stainless Steel
Stuffing box packing	PTFE Chevron
Disc seal	Bronze PTFE
Valve body seal	Graphite
Wiper seal	TFE/P

Specifications

Fluid: Steam, superheated water, corrosive fluids

Fluid Temperature Range: 14°F to 482°F (-10°C to 250°C)

Ambient Temperature Range: -13°F to 356°F (-25°C to 180°C)

Maximum Viscosity: 23,500 SSU

Options

For other pipe connections, alternate pilot valves and construction options, please consult factory

Pilot Valve

8356 Series

- In-line mount
 - 1/8" or 1/4" NPT
 - Brass or Stainless Steel
- (see 8356 catalog page for specifications)

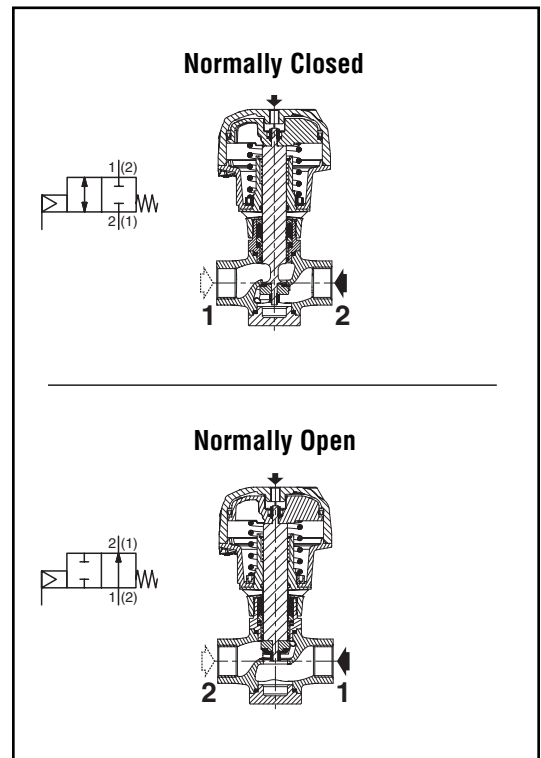

SPECIAL SERVICE VALVES

Installation

Valve can be mounted in any position

Specifications (English units)

Pipe Size (in)	Cv Flow		Operating Pressure Differential (psi)		Stainless Steel	Air Pilot Pressure (psi)		Const. Ref.	Approx. Shipping Weight (lbs.)
	Ports 1 - 2	Ports 2 - 1	Min.	Max. ①		Min.	Max.		
80mm Operator									
Normally Closed									
1/2	5.0	5.8	0	580	8298A001	②	145	1	4.0
Normally Open									
1/2	4.0	4.0	0	580	8298A007	③	145	1	4.0
100mm Operator									
Normally Closed									
3/4	8.9	9.7	0	580	8298A002	②	145	2	7.5
1	12	13	0	580	8298A003	②	145	3	9.3
Normally Open									
3/4	8.3	8.1	0	580	8298A008	③	145	2	7.7
1	12	12	0	580	8298A009	③	145	3	9.1
150mm Operator									
Normally Closed									
1 1/4	20	20	0	580	8298A004	②	145	4	21
1 1/2	32	32	0	580	8298A005	②	145	5	27
Normally Open									
1 1/4	20	17	0	580	8298A010	③	145	4	21
1 1/2	32	32	0	580	8298A011	③	145	5	27
200mm Operator									
Normally Closed									
2	66	66	0	580	8298A006	②	145	6	53
Normally Open									
2	61	61	0	580	8298A012	③	145	6	49

① 580 psi within the specified fluid temperature limits, see Diagram 1

② Minimum pilot pressure for Normally Closed varies with differential pressure. See Chart A.

③ Minimum pilot pressure for Normally Open varies with differential pressure. See Chart B.

SPECIAL SERVICE VALVES

Diagram 1

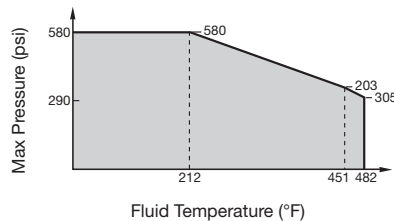

Chart A

Minimum Pilot Pressure Normally Closed

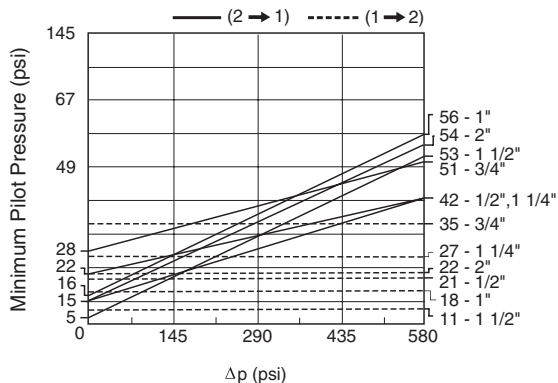
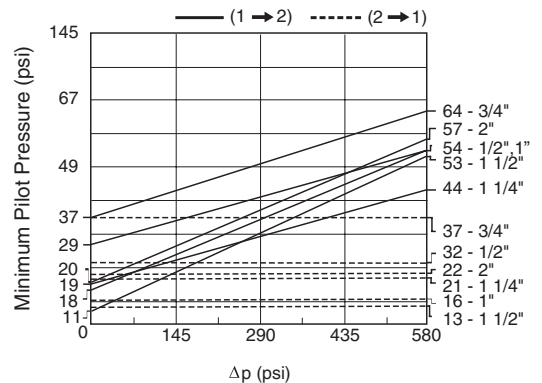

Chart B

Minimum Pilot Pressure Normally Open



Specifications (Metric units)

Pipe Size (mm)	Kv Flow Factor (m³/h)		Operating Pressure Differential (bar)		Stainless Steel	Air Pilot Pressure (bar)		Const. Ref.	Approx. Shipping Weight (kgs)
	Ports 1 - 2	Ports 2 - 1	Min	Max. ①		Min.	Max.		
80mm Operator									
Normally Closed									
15	4.3	5.0	0	40	8298A001	②	10	1	1.8
Normally Open									
15	3.5	3.5	0	40	8298A007	③	10	1	1.8
100mm Operator									
Normally Closed									
20	7.7	8.4	0	40	8298A002	②	10	2	3.4
25	11	12	0	40	8298A003	②	10	3	4.2
Normally Open									
20	7.2	7.0	0	40	8298A008	③	10	2	3.5
25	11	11	0	40	8298A009	③	10	3	4.1
150mm Operator									
Normally Closed									
32	18	18	0	40	8298A004	②	10	4	9.3
40	28	28	0	40	8298A005	②	10	5	12
Normally Open									
32	18	15	0	40	8298A010	③	10	4	9.3
40	28	28	0	40	8298A011	③	10	5	12
200mm Operator									
Normally Closed									
50	57	57	0	40	8298A006	②	10	6	24
Normally Open									
50	53	53	0	40	8298A012	③	10	6	22

① 40 bar within the specified fluid temperature limits, see Diagram 1
 ② Minimum pilot pressure for Normally Closed varies with differential pressure. See Chart A.
 ③ Minimum pilot pressure for Normally Open varies with differential pressure. See Chart B.

Diagram 1

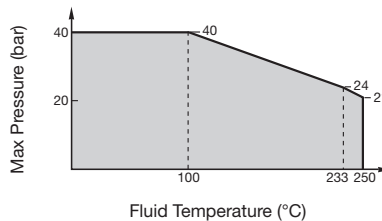

Chart A

Minimum Pilot Pressure
Normally Closed

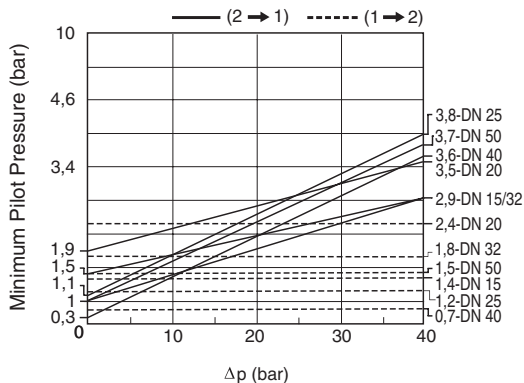
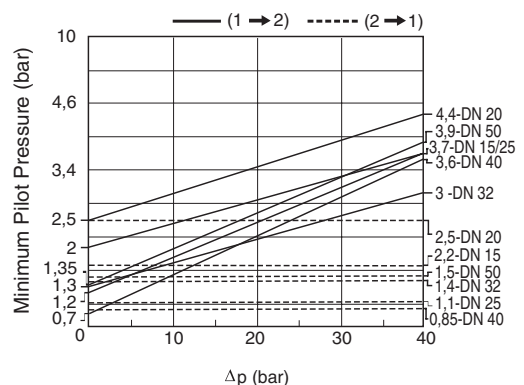

Chart B

Minimum Pilot Pressure
Normally Open



Dimensions inches (mm)

Const. Ref		ØAA	ØA	ØB	C	D	E	G	ØH	ØP	Q
1	in	1/2	0.59	4.3	7.2	6.0	3.3	NPT 1/8	1.3	3.7	1.3
	mm	15	15	110	184	152	85		33	95	33
2	in	3/4	0.79	5.2	8.3	6.7	4.3	NPT 1/8	1.6	4.6	1.5
	mm	20	20	133	210	171	110		40	117	39
3	in	1	0.98	5.2	8.9	7.1	4.7	NPT 1/8	1.8	4.6	1.8
	mm	25	25	133	225	181	120		46	117	45
4	in	1 1/4	1.3	7.5	11	9.3	5.7	NPT 1/4	2.2	6.8	2.2
	mm	32	32	191	291	237	145		57	173	54
5	in	1 1/2	1.6	7.5	13	10	5.9	NPT 1/4	2.6	1.8	2.6
	mm	40	40	191	326	259	150		65	173	67
6	in	2	2.0	9.7	16	13	7.5	NPT 1/4	3.0	9.1	3.2
	mm	50	50	247	409	329	190		75	230	81

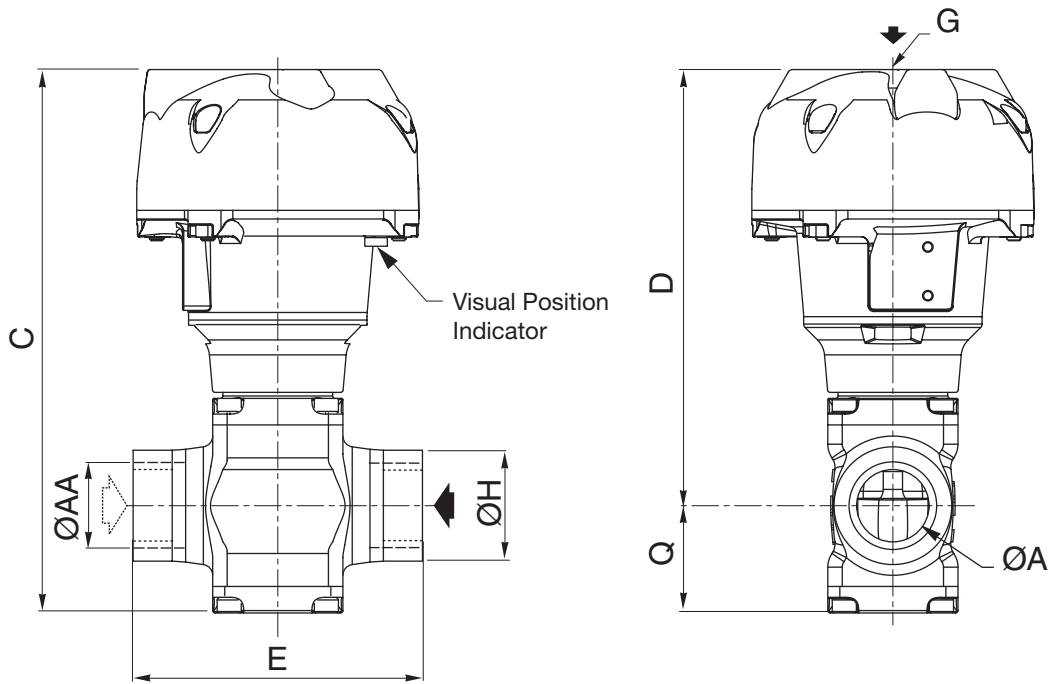

Top down view

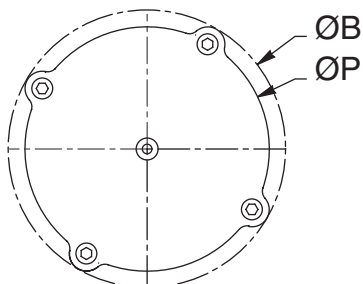

Catalog Number	Spare Parts Kit
8298A001	C140311
8298A002	C140313
8298A003	C140315
8298A004	C140317
8298A005	C140319
8298A006	C140321
8298A007	C140312
8298A008	C140314
8298A009	C140316
8298A010	C140318
8298A011	C140320
8298A012	C140322

SPECIAL SERVICE VALVES