

Profiler™ 2

SHORT RANGE DISTANCE SENSOR





Copyright protection!

This work is copyright-protected. The rights founded by this shall remain with company SICK AG. Reproduction of the work or parts of this work shall only be permissible within the limits of the legal provisions of copyright law. Changes and abbreviations of this work are prohibited without the express written agreement of SICK AG.

Table of contents

1	Introduction.....	8
1.1	Warranty.....	8
2	Safety Precautions.....	9
2.1	Safety Precaution Symbols.....	9
2.2	Mandatory Precautions.....	9
2.3	Precautions for Laser Use.....	10
2.3.1	Installation Precautions.....	10
2.4	Warning Labels.....	11
3	Information Before Use.....	12
3.1	General Description.....	12
3.2	Package Contents.....	13
3.2.1	Included Items.....	13
3.2.2	Options.....	13
3.3	Names and Functions of Parts.....	14
3.3.1	Sensor.....	14
3.3.2	Laser Emission and Measurement Ranges.....	15
3.3.3	Cable Wire Colors and Roles.....	16
3.4	Installation.....	17
3.4.1	Notes for installation.....	17
3.4.2	Installing the Sensor.....	17
4	Setup and Measurement Procedures.....	18
4.1	Before Using the Profiler 2.....	18
4.1.1	Procedure for Using the Sensor.....	18
4.1.2	Setup and Measurement Process.....	19
4.2	Quick Setup.....	20
4.2.1	Basic Measurement Settings.....	20
4.2.2	Return to Main Menu/Measurement Screen.....	21
4.2.3	Initialize Settings.....	22
5	Operating the Sensor.....	23
5.1	Sensor Screen.....	23
5.1.1	Details of the Screen.....	23
5.1.2	Screen Types and Switching Between Screens.....	24
5.1.3	Key Lock Function.....	25
5.2	Main Screen.....	25

5.2.1	Main.....	25
5.2.2	Input/Trigger	26
5.2.3	Storage	27
5.2.4	Other.....	30
5.3	Setting.....	32
5.3.1	Camera.....	32
5.3.2	Profile.....	35
5.3.3	Area.....	38
5.4	Graph/Calc.....	40
5.4.1	Graph Items (Area 1 to area 4).....	41
5.4.2	Calc Items (Calculation 1 and calculation 2)	42
5.5	Output.....	43
5.5.1	Output Items (OUT1 to OUT3)	44
5.5.2	Output Items (OUTA)	45
6	PR02-Navigator Setup Software.....	47
6.1	Setup Software Requirements.....	47
6.1.1	Operating Environment.....	47
6.2	Software Setup	48
6.2.1	Installing the Driver.....	48
6.2.2	Install the Software.....	49
6.2.3	Settings for High-speed Communication	50
6.3	PR02-Navigator Screen and Operating	51
6.3.1	Start PR02-Navigator.....	51
6.3.2	Main Screen (Measurement Screen)	51
6.3.3	Common Setup	53
6.3.4	How to Change Settings	54
6.4	Setup Procedure	55
6.4.1	Connecting to the Sensor Head.....	55
6.4.2	Input/Trigger Settings.....	56
6.4.3	Camera Settings	57
6.4.4	Profile Settings.....	59
6.4.5	Area Settings.....	61
6.4.6	Calculation Settings.....	63
6.4.7	Output Settings	64
6.5	Storage Function.....	65

6.5.1	Storage Settings.....	65
6.5.2	Data storage.....	66
6.5.3	Profile storage.....	67
7	Functions.....	69
7.1	Settings Lists and Factory Settings.....	69
7.2	Input/Trigger Settings.....	74
7.2.1	IN1/IN2/IN3/IN4.....	74
7.2.2	Reset/Inner hold/Inner trig.....	74
7.2.3	Input polar, Inp filter.....	75
7.2.4	Trig action.....	75
7.2.5	Offset target.....	75
7.3	Storage Settings.....	76
7.3.1	Storage.....	76
7.3.2	Start cond.....	76
7.3.3	Intermittent.....	77
7.3.4	Repeat.....	77
7.4	Camera Settings.....	78
7.4.1	Camera Mode.....	78
	Operation of the camera mode.....	80
	Mandatory settings when using HDR.....	82
7.4.2	Image Brightness (Shutter Time and Gain).....	83
7.4.3	Camera Range.....	84
7.4.4	Received Light Waveform and Measurements.....	85
7.5	Profile Settings.....	86
7.5.1	Profile Extraction Settings.....	86
7.5.2	Save Master.....	89
7.5.3	Profile Correction.....	90
7.6	Area Settings.....	95
7.6.1	Measurement Areas.....	95
7.6.2	Measurement functions.....	96
7.7	Calculation Settings.....	100
7.7.1	Average.....	100
7.7.2	Hold.....	100
7.7.3	Span.....	101
7.7.4	Calculation Formulas.....	101

7.8	Output Settings.....	102
7.8.1	Out target	102
7.8.2	Thresholds and Output.....	102
7.8.3	Out action	104
7.8.4	Offset/Offset Value	105
7.8.5	Analog Output Range.....	107
7.9	Common Settings	108
7.9.1	Banks.....	108
7.9.2	Baud rate.....	108
7.9.3	Axis dir	109
7.9.4	On Timing	109
7.9.5	Lang/言語	109
7.9.6	Screen Saver	110
7.9.7	Brightness	110
7.9.8	Initialize	110
7.9.9	Version.....	110
8	Serial Communication	111
8.1	Communication Specifications	111
8.1.1	Communication Specifications	111
8.1.2	Timing Chart During Communication	111
8.1.3	Command Format.....	112
8.2	How to Acquire Measured Values.....	113
8.2.1	Commands for Acquiring Measured Values.....	113
8.2.2	Communication Command Examples	113
8.3	How to Acquire Profiles.....	114
8.3.1	Commands for Acquiring Profile Data	114
8.3.2	How to Acquire Profile Data.....	114
8.4	Storage Data Acquisition Method.....	116
8.4.1	Commands for Acquiring Storage Data	116
8.4.2	How to Acquire Storage Data	117
8.5	Setting Acquisition and Change Commands	119
8.5.1	Communication Command Examples	119
8.5.2	Writing Settings to EEPROM.....	120
8.5.3	Camera Settings	120
8.5.4	Profile Settings.....	122

8.5.5	Area Settings.....	123
8.5.6	Calculation Settings.....	125
8.5.7	Output Settings.....	127
8.5.8	Input Settings.....	130
8.5.9	Storage Settings.....	131
8.5.10	Other Settings.....	133
9	Specifications.....	134
9.1	Specifications.....	134
9.2	Connection diagram.....	135
9.2.1	Input Circuit Diagram.....	135
9.3	Dimensions.....	136
9.4	Timing Charts.....	137
9.4.1	Measurement.....	137
9.4.2	I/O.....	139

1 Introduction

Before using this product, confirm that the product you have received is the product that you requested.

- Read this manual thoroughly, and then keep this manual at hand so that it can be used whenever necessary.
- If you lose this manual or if you have any questions regarding the contents contained herein, contact our distributor from whom you purchased the product or download PDF from www.sick.com.
- Trademarks and registered trademarks appearing in this manual are the property of their respective owners.
- The copyright of this manual is owned by SICK AG. All the contents contained herein are protected by copyright law. Unauthorized copying of this manual is strictly prohibited.

1.1 Warranty

SICK AG products have undergone strict inspections. However, should your product malfunction, confirm the symptoms of the malfunction, and then contact our distributor from whom you purchased the product.

- The warranty period of this product is 1 year from the time of purchase.
- If a malfunction occurs attributable to the manufacturer, the product will be replaced free of charge (a replacement will be sent).

However, the following cases are not covered by the warranty.

1. Malfunction caused by improper handling or usage.
2. Malfunction caused by something other than this product.
3. Malfunction caused by unapproved modifications or repairs.
4. Malfunction caused by a natural disaster.

The warranty described here is limited to the delivered product. SICK AG accepts no responsibility for any subsequent damages caused by a product malfunction.

2 Safety Precautions

Read this manual carefully to ensure safe and correct use of this product. This manual contains safety precautions that are designed to protect your health and property as well as the health and property of any other users of this product. Follow the installation and operating procedures described in this manual, and do not use this product in any manner not described herein.

2.1 Safety Precaution Symbols



WARNING

Indicates that incorrect use may lead to a hazardous situation resulting in injury or death.



CAUTION

Indicates that incorrect use may lead to a hazardous situation resulting in injury or property damage.

2.2 Mandatory Precautions



WARNING

- Do not look directly at the laser beam or intentionally shine the laser beam in another person's eyes. Doing so may cause eye damage.
 - This product cannot be used as protective equipment for the purpose of protecting the human body.
 - Disassembling or modifying this product may cause injury, fire, or electric shock.
 - If you detect smoke or a strange odor during operation, stop operating the product, and then stop the power supply. If repairs are necessary, inform the distributor that you purchased the product from.
 - Use the product with the voltage indicated in the specifications.
 - Do not touch the product or its cable with wet hands. Doing so may lead to electric shock.
 - Do not perform wiring while the power supply is on.
-

2.3 Precautions for Laser Use

**WARNING!**

- This product emits a Class 2 (II) visible laser beam that is compliant with JIS/IEC/FDA laser safety standards.
 - A Class 2 (II) warning and explanation label is affixed to the sides of this product.
 - If you install this product in a piece of machinery that will then be exported to the United States, you first need the approval of the American Food and Drug Administration (FDA).
 - If you install this product in your own equipment, clearly indicate to the end user that this is a laser product and provide explanations that ensure correct handling of the product.
-

2.3.1 Installation Precautions

**WARNING!**

- Installing this product in a location with any of the following conditions may lead to fire, electric shock, or malfunction:
 - High humidity
 - High temperatures caused by direct sunlight, etc.
 - Very dusty
 - Poor ventilation
 - High static electricity
 - Corrosive or flammable gas is present
 - Product is exposed to liquids such as water, oil, and chemicals
 - Product is directly subjected to vibration or shock
 - Leave the power supply off during wiring.
-

**CAUTION**

- Avoid wiring in parallel with or in the same piping as high-voltage wires or power lines. Doing so may lead to malfunctions caused by noise. Also, shorten the power supply and signal wires as much as possible.
 - Be careful to avoid damaging the cables by pulling on or applying unnecessary force on them.
-

2.4 Warning Labels

This section explains the contents and affixing position of the warning label used on this product.

A laser beam is used in the location where this warning label is affixed. Looking directly at the laser beam may lead to loss of eyesight. Be sure to follow the precautions shown below.

1. Do not look at the laser beam.
2. Do not remove the protective cover.
3. All individuals other than the proper operator must not approach the product.

EN/IEC 60825-1:2014

Laser radiation – Do not look into the laser beam – Laser class 2 (EN/IEC 60825-1:2014)

Complies with 21CFR1040.10 and 1040.11 except for deviations pursuant to laser notice No. 50, date June 24, 2007

Identical laser class for issue EN/IEC 60825-1:2007

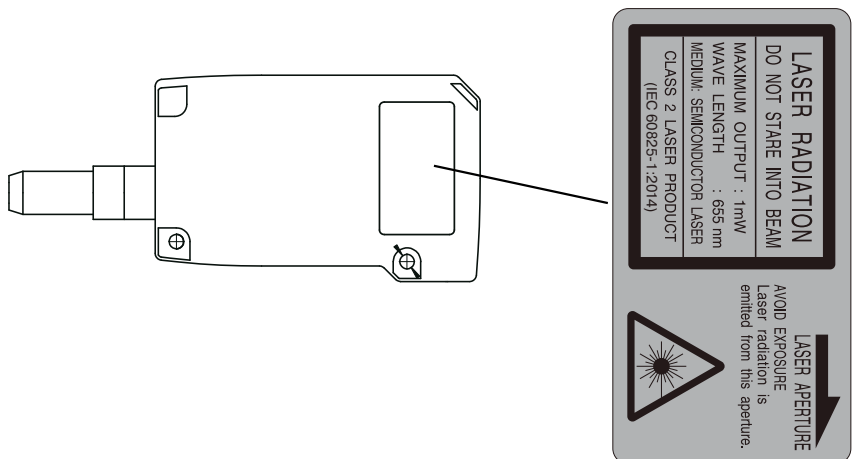
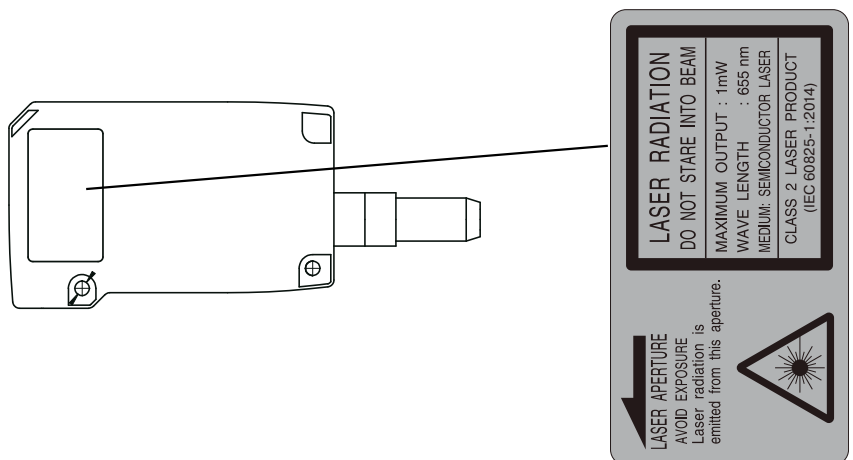

3 Information Before Use

3.1 General Description

The Profiler 2 is a high-precision profile measurement sensor. The characteristics of this product are shown below.

- This product achieves high-precision measurement by emitting a band-shaped laser beam and using a light-plane-intersecting method that triangulates the reflected light.
- Settings can be configured, measurements can be performed, and output can be generated from the sensor. No amplifier unit or other auxiliary devices are necessary.
- Various settings can be set from the sensor or from the dedicated setup software (PRO2-navigator).
- It is possible to measure 4 areas with a single measurement. For each area, there are 13 types of measurement functions to select from.
- There are 4 camera modes available. This enables you to select the optimum settings to match the environment of the production line to be measured and the state of the target object.

With the light-plane-intersecting method, the reflected light from the emitted band-shaped laser beam is received by the light receiving element (CMOS), and the profile is then measured from the resulting image data. With the light-plane-intersecting method, two processes are used to determine the height and position.

- Triangulation: To determine the height, this process obtains the received light waveform (the waveform of the reflected light) for each vertical line of the image.
- Projection transformation: To determine the horizontal position, this process mathematically calculates the actual position from the image data.

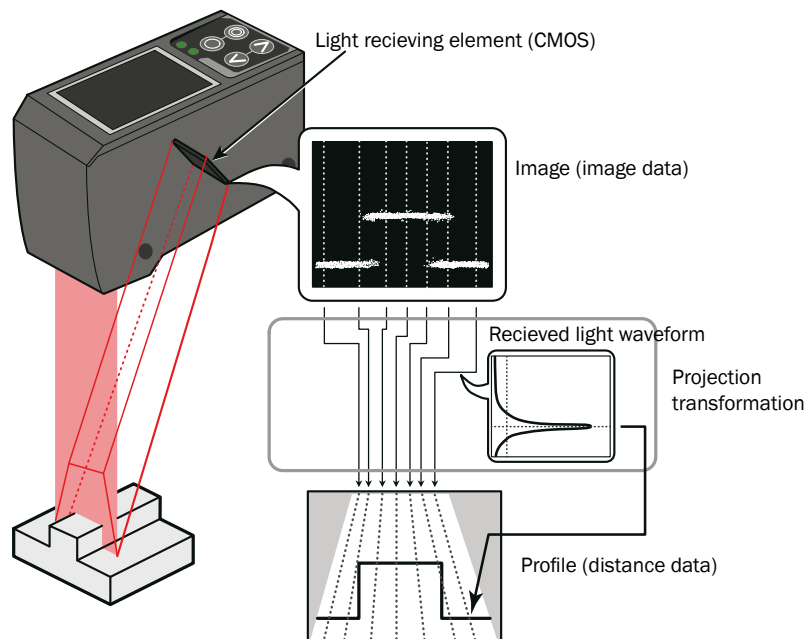

Figure: Schematic diagram of Profiler 2 series measurement

3.2 Package Contents

3.2.1 Included Items

Before using this product, confirm that the following items are contained in the package:

- Sensor
- Mounting screws, M4 × 50 mm (2 pieces)
- Quickstart
- Setup software PRO2-navigator and User manual (USB flash drive)
- Laser warning labels (2 pieces)

3.2.2 Options

Prepare the following options as necessary.

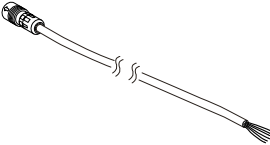
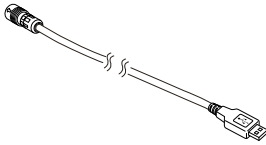
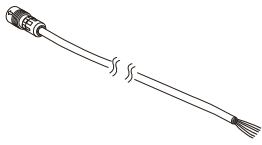
Main cable	Communication cable (USB)	Communication cable (discrete wire)
		
6053017, STL-OH12-G02M (2 m)	6053020, DSL-DH06-G1M8 (1.8 m)	6053021, DOL-SH06-G02M (2 m)
6053018, STL-OH12-G05M (5 m)		6053196, DOL-SH06-G05M (5 m)
6053019, STL-OH12-G10M (10 m)		6053197, DOL-SH06-G10M (10 m)

Information Before Use

3.3 Names and Functions of Parts

3.3.1 Sensor

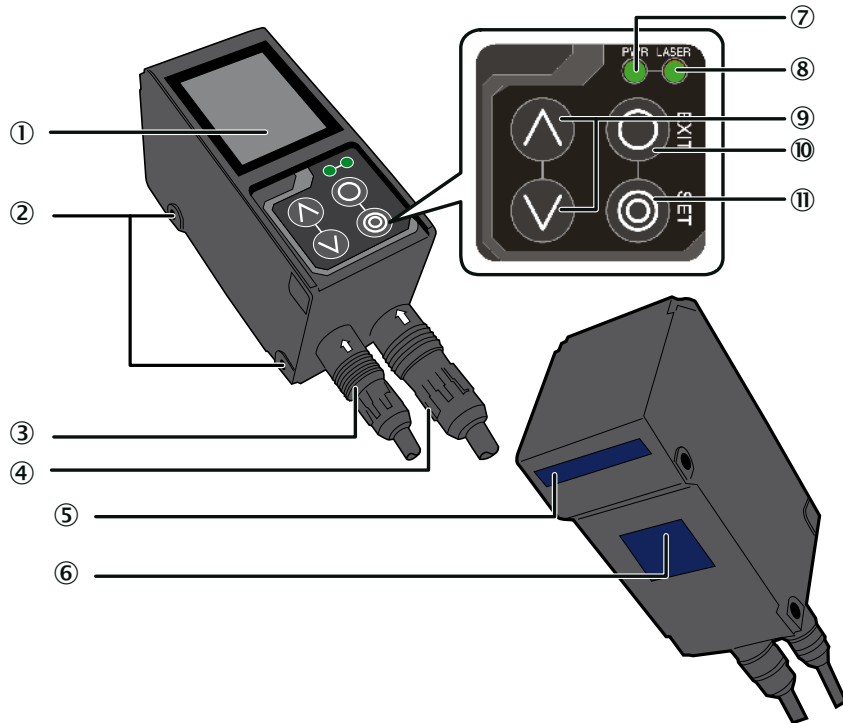

Number	Name	Function
①	LCD display	This part displays measured results and setting screens.
②	Mounting holes	Screws are inserted into these holes to fix the sensor in place. (Diameter: 4.2 mm)
③	Connector for communication cable	Insert a communication cable into this connector to connect the PC and the sensor.
④	Female connector, HRS, 12-pin cable	Insert the main cable for power, I/O, and analog output into this connector.
⑤	Sender area, z-axis	The laser beam is emitted from this window.
⑥	Field of view, x-axis	The reflected laser light is enters this window.
⑦	LED Indicator for power on (green)	This indicator lights when the power is on.
⑧	LED Indicator for Laser on (green)	This indicator lights during laser emission.
⑨	Cursor keys	Use these keys to select setting items.
⑩	EXIT button	Press this button to cancel setting details. Hold down this button (> 1 s) to switch to the main menu.
⑪	SET button	Press this button to confirm setting details.



WARNING

When using the sensor, never look into the laser exposure window ⑤. Looking directly at the laser beam may lead to loss of eyesight.



WARNING

Put the rubber cap on the connector which is not used to protect from dust and water.



Note!

When using the sensor, do not cover the Sender area ⑤ or the Field of view ⑥.

3.3.2 Laser Emission and Measurement Ranges

The sending and receiving area of this product are shown below.

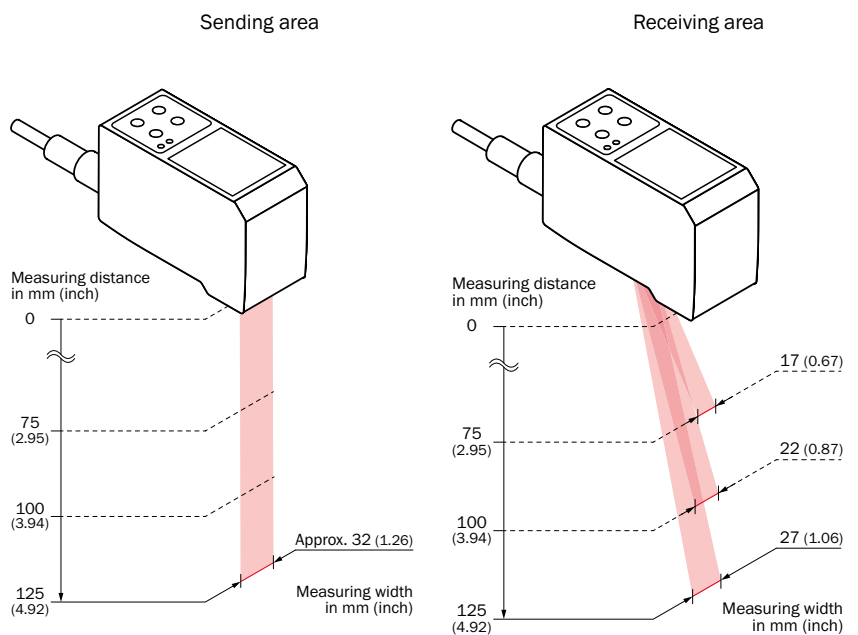

3.3.3 Cable Wire Colors and Roles

This section explains the colors of the wires and the roles of the Profiler 2 cables.

Main cable

This cable is used to supply power to the Profiler 2 and for I/O connections.

Color	Input or output	Description
Purple	Input	Bank 1/reset
Orange	Input	Bank 2/hold
Gray (narrow)	Input	Bank 3/trigger
White	Input	Offset/stop laser emission
Gray (coaxial core)	Output	Analog output (4 to 20 mA)
Gray (coaxial shield)	—	Analog GND
Green	—	Ground GND
Yellow	Output	OUT1
Black	Output	OUT2
Red	Output	OUT3
Blue	—	Power supply GND
Brown	—	12 to 24 V input

RS-485 cable

This cable is used for RS-485 communication between the Profiler 2 and a PLC or similar device.

Color	Input or output	Description
Orange	—	+A
Yellow	—	-A
Black	—	GND
Red	—	(N.C.)
Brown	—	(N.C.)
Green	—	(N.C.)

Reference: For the I/O circuit diagram, see “9.2 Connection diagram.”

3.4 Installation

3.4.1 Notes for installation

When you install this product, ensure that there is sufficient space around the product in order to prevent overheating.

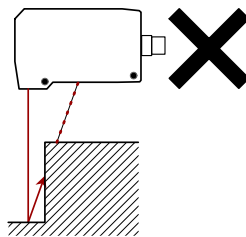
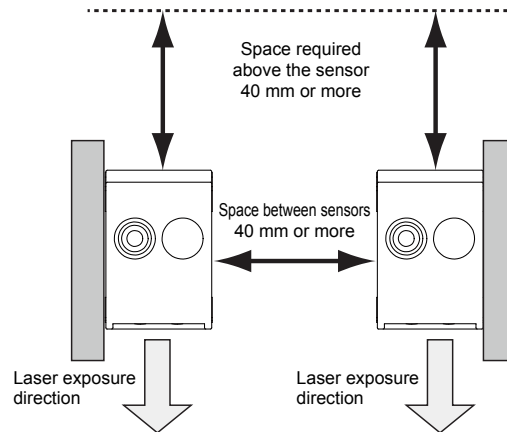

The Profiler 2 performs measurements by emitting a parallel laser beam and receiving the reflected light.

During measurement, ensure that the laser beam and reflected light is not blocked by the target object.

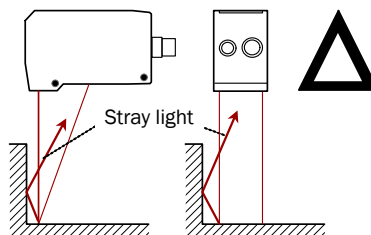

Before using the product, check that stray light, which is reflected by a wall or by highly reflective objects, does not have an effect on the measurements.

3.4.2 Installing the Sensor

1. Insert the included mounting screws (two M4 × 50 mm screws) into the mounting holes to temporarily affix the sensor to a location that is roughly in the desired location.
2. Measure the distance between the sensor and the detection target object. Please make sure the measuring object is within the measuring area.
3. Adjust the sensor position on the basis of the measurement result, and then use the included nuts and washers to fix the screws in place.

4 Setup and Measurement Procedures

4.1 Before Using the Profiler 2

4.1.1 Procedure for Using the Sensor

Before you use the Profiler 2, install and setup the sensor according to the procedure shown below.

1. Installation and light axis adjustment

Install the sensor such that you can perform accurate measurements of the measurement target.

Reference: For details on the installation of the sensor, see "3.4 Installation."

2. Wiring

Connect the cables.

3. Settings

Configure the settings related to measurement. You can use one of the following methods to configure the settings.

1. Sensor
 - Configure all the settings from the Profiler 2.
2. PRO2-Navigator
 - Use the dedicated PRO2-Navigator setup software to intuitively view and change all the settings.
3. Serial communication
 - Use RS-485 communication to view and change all the settings of the Profiler 2.

4. Measurement

Perform measurements.

With the Profiler 2, measurement results can be output using one of the following methods.

1. Judgment output (control output)
 - The Profiler 2 is equipped with three judgment outputs (control outputs).
2. Analog current output (4 to 20 mA)
3. Serial communication (RS-485 communication)
4. PRO2-Navigator (monitor display of measured values)

Tips: • *Serial communication or PRO2-Navigator is required to output and check stored data.*

4.1.2 Setup and Measurement Process

The Profiler 2 performs measurements according to the following flow. Settings are also performed for each of these items.

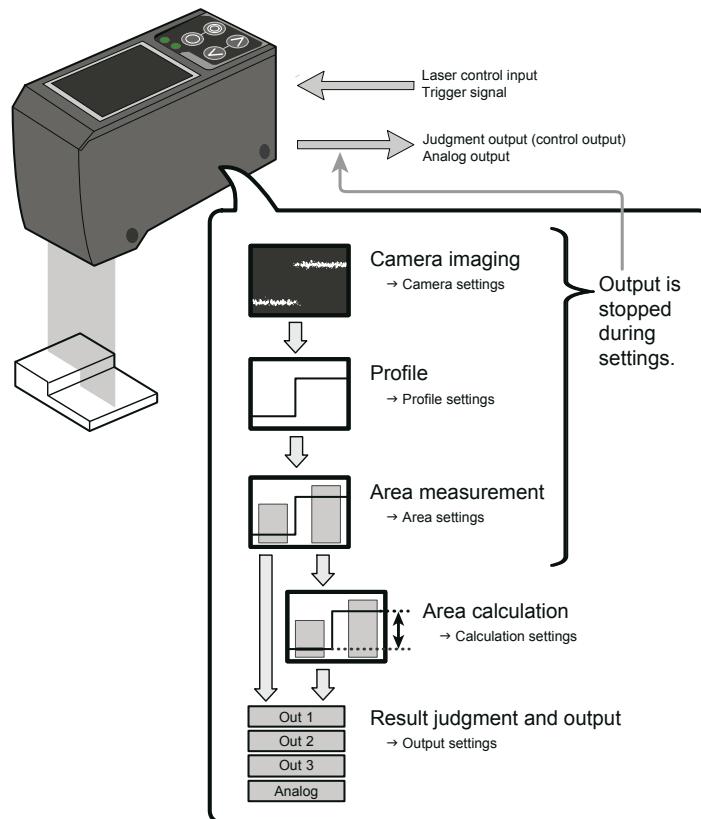

1. Trigger
 - Images are captured when the set conditions are met.
2. Camera
 - An image is captured based to the settings.
3. Profile acquisition
 - The profile (the sectional profile made by the reflected laser light) is acquired from the image.
4. Area measurement
 - The specified position within the profile is measured.
5. Area calculation
 - If necessary, the measured result of the area is calculated. e. g. Area 1 – Area 2 = Calc 1)
6. Result judgment and output
 - The measured result is compared against the threshold, and then the judgment result is output.

Tips: • With the Profiler 2, you can save settings related to measurements in "banks." Up to eight banks can be saved.

Reference: For details on banks, see "7.9.1 Banks."

4.2 Quick Setup

4.2.1 Basic Measurement Settings

You can take basic measurements simply by setting the following three items. Configure the settings from the sensor or from the PRO2-Navigator setup software.

- Shutter time
- Area
- Output conditions

Reference: For the actual screens and for information on the operations, see the following pages.

Configuring settings from the sensor → “5.3 Setting.”

Using PRO2-Navigator → “6.3 PRO2-Navigator Screen and Operating.”

1. Set the shutter time

Position the measurement target, and then perform automatic adjustment. The optimum shutter time will be set.

2. Set the area

Use the area setting to specify what part you will measure and how that part will be measured.

1. Measurement area
 - Set what part within the measurement range will be measured. The set area must intersect the profile (the sectional waveform).
2. Measurement function
 - Set the measurement function. You can select from functions such as height and width.

Reference: For details on the area settings, see “7.6 Area Settings.”

3. Set the output conditions



Configure the settings related to the output of the measured results. First, specify the judgment and output target area.

- Output target
Select the target area (area 1 to area 4 and calculation 1 and calculation 2).
1. Measurement output
The product judges whether the measurement is a pass or a fail, and then outputs the result.
 - Upper limit/lower limit
 2. Analog current output (4 to 20 mA)
 - 4 mA/20 mA
Set the lower and upper limits of the analog output range.

4.2.2 Return to Main Menu/Measurement Screen

When you have finished configuring settings or when you are not sure what menu you are currently on, you can follow the procedures below to return to the main menu (the measurement screen).

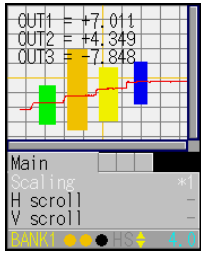
Related page





	Screen image	Operation
Sensor screen		Hold down the  "EXIT" button. * For the "In/Trig" and "Other" tab, you need to select the tab, and then hold down the "SET" button to return to the main menu.
Setup software		Click "Back to Measure."

Setup and Measurement Procedures

4.2.3 Initialize Settings

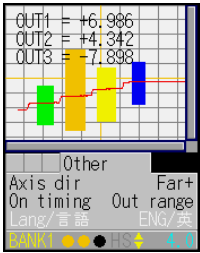
This section describes how to initialize settings.
You can initialize one bank at a time or all banks at the same time.

Related page

	Screen image	Operation
Sensor screen		<p>To initialize settings, on the “Other” tab, display the “Initialize” menu, select “Bank” or “All,” and then press the  “SET” button.</p> <p>When the confirmation screen displays the message “Reset to factory initial value.,” press the  “SET” button again to execute initialization.</p>
Setup software		<p>On the measurement screen, click “Common Setup.” The Common Setup screen displays. Click the target that you want to initialize, and click “Bank Clear.” A confirmation dialog displays. Click “Yes” to execute initialization.</p>

Tips: • If you select “All” on the initialization menu, the Profiler 2 will restart.

5 Operating the Sensor

5.1 Sensor Screen

5.1.1 Details of the Screen

This section explains the details of the screen display.

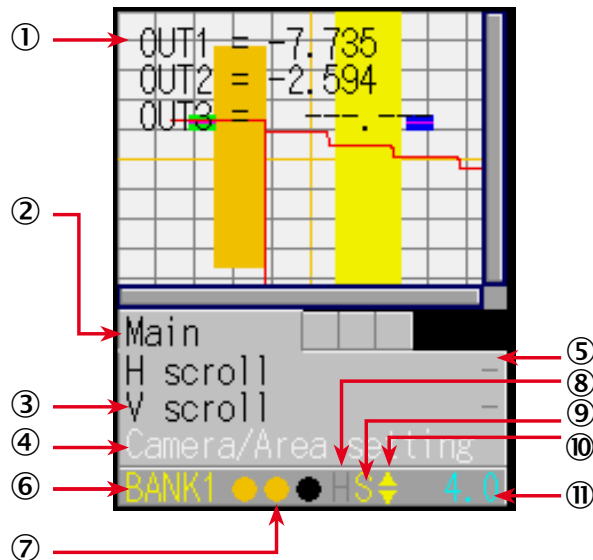

Number	Display item	Description	Operation
①	Main screen	The camera screen, profile waveform, and set area are displayed here.	—
②	Tab	The menu categories are displayed here. You can also select this part.	Move the cursor to the tab, and then press the "SET" button to switch between the tabs in order. When not selected: Black When selected: Blue
③	Setting menu	The setting menu is displayed here. Three settings are displayed at one time.	—
④	Setting menu (selected)	When a setting is selected, the color changes.	When selected: White When setting the parameter: Yellow
⑤	Parameter	The parameters for the settings are displayed here.	When item selected: White When setting the parameter: Yellow
⑥	Bank number	The current bank number is displayed here.	—
⑦	Output	The control output statuses are displayed here in the order – from the left – control output 1, control output 2, control output 3.	When output is off: Black When output is on: Orange
⑧	Hold input	When the input is being held, an "H" is displayed here.	When input is being held: "H" displayed in yellow
⑨	Storage function	The storage function operation status is displayed here.	Trigger standby: Green Storing: Yellow
⑩	Cursor/Key Lock	A cursor that indicates the direction that the screen can move in is displayed here or a "L" that indicates the activated key lock.	When the screen can move up: ▲ When the screen can move down: ▼ When the screen can move up and down: ▲▼ When the keys are locked: L
⑪	Sampling period	The sampling period is displayed here. The unit is "ms."	—

Operating the Sensor

5.1.2 Screen Types and Switching Between Screens

This section explains the types of screens and how to switch between the screens.

The following screens are available on the Profiler 2.

You can switch between screens by selecting the screen on the main screen or by pressing the **SET** button with the tab selected.

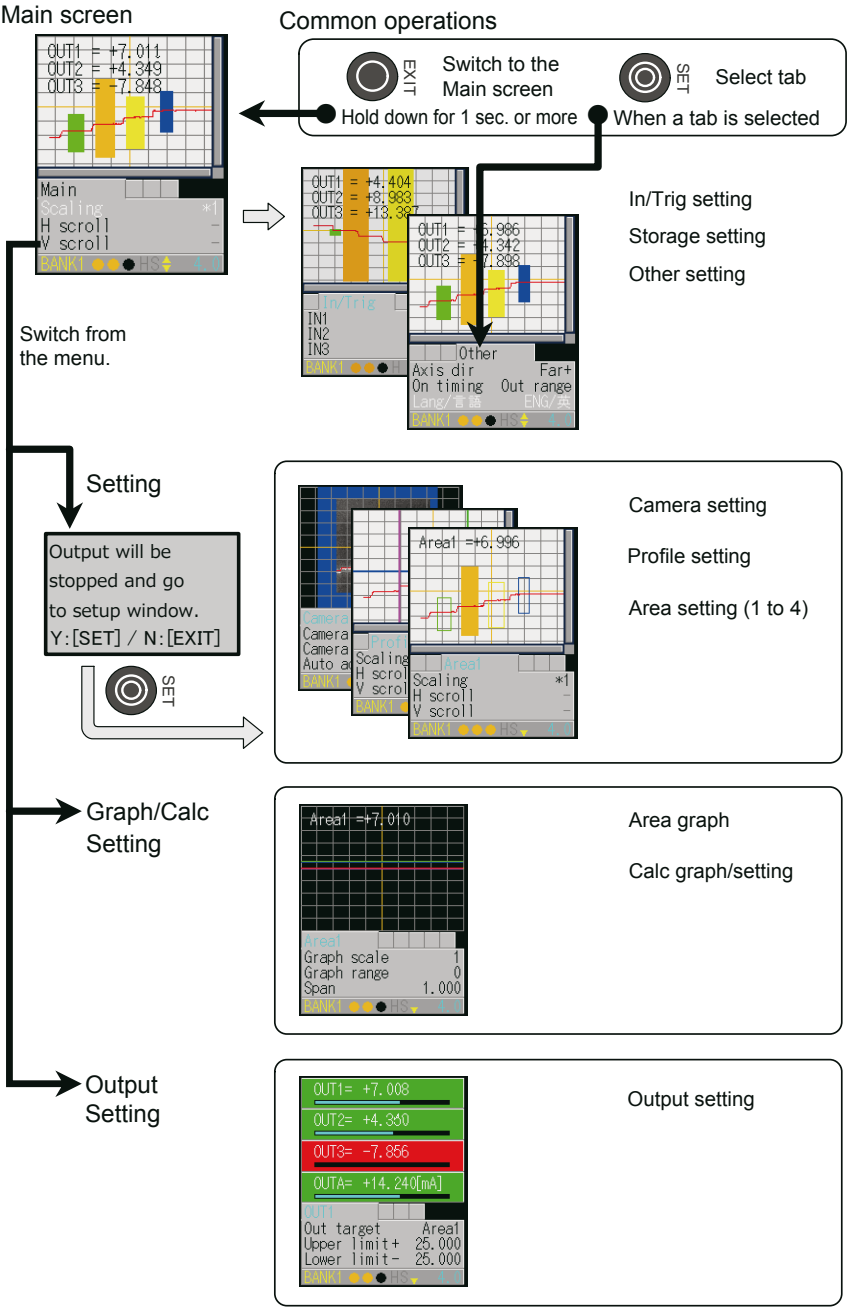

Also, if you hold down the **EXIT** button on any screen, you will return to the main screen. (Excluding the “Input/Trigger” and “Other” screens.)



5.1.3 Key Lock Function

Key Lock is available to prevent miss-operation. It can be activated or released by pressing buttons.

- Activate Key Lock

Hold down the  "EXIT" button and the  "Down Cursor" button at a time for 3 seconds.

While keys are locked, the cursor shows as "L".



- Operation while Key Lock is activated

When any keys are pressed while Key Lock is activated, following message will be shown.

"KEY LOCK You can not operate without unlock"

Setting through communication I/F is available while Key Lock is activated.

- Release Key Lock

Hold down the  "EXIT" button and the  "Down Cursor" button at a time for 3 seconds.

While keys are released, the cursor shows as "▲" or "▼"..

5.2 Main Screen

This section explains the items that can be selected on the main screen and the operations of these items.

Table items marked in the following table with "Y"(= Yes) in the "Bank" column can be set for each bank. In the same manner, items that have an "N" (= No) for their bank are shared between all banks.

5.2.1 Main

If you hold down the  "EXIT" button on any screen, you will return to this screen.

(Excluding the "Input/Trigger" and "Other" screens.)

You can switch to each other screen from this screen.

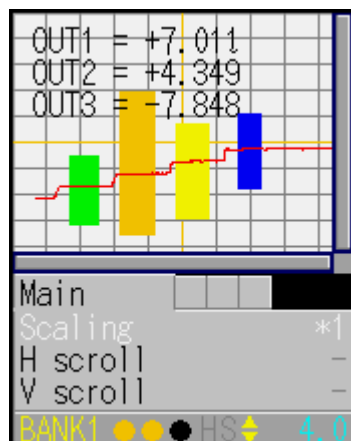

Setting item	Bank	Setting value/ default value	General description
Scaling	Y		Expand or shrink the display range.
		*1	Display at 100% size. The whole range will be displayed.
		*2	Display at 200% size.
		*4	Display at 400% size.
		*8	Display at 800% size.
		*16	Display at 1600% size.
	*32	Display at 3200% size.	
H scroll	Y	—	Move the display position horizontally.
V scroll	Y	—	Move the display position vertically.
Camera/ Area setting	—		Switch to the setting screen.
Graph/ Calc setting	—		Switch to the calculation setting screen. The measured result will be displayed as a graph.
Output	—		Switch to the output display/setting screen.

5.2.2 Input/Trigger

Set the operation of the input terminals and of the camera start trigger.

Setting item	Bank	Setting value/ default value	General description
IN1	N		Set the behavior of external input terminal IN1.
		BANK1	IN1 is used as the first bit for switching banks.
		Reset	IN1 is used as the reset input terminal.
IN2	N		Set the behavior of external input terminal IN2.
		BANK2	IN2 is used as the second bit for switching banks.
		Hold	IN2 is used as the hold input terminal.
IN3	N		Set the behavior of external input terminal IN3.
		BANK3	IN3 is used as the third bit for switching banks.
		Trigger	IN3 is used as the trigger input terminal.
IN4	N		Set the behavior of external input terminal IN4.
		Offset	IN4 is used as offset input.
		LaserOFF	IN4 is used as the laser emission stop input.
Reset	—		Execute the reset operation.
		Wait...	This is displayed when the reset operation is being executed.

Setting item	Bank	Setting value/ default value	General description
Inner hold	—		Each time that the SET button is pressed, the hold function will be turned on or off. The condition to enable this function is: IN2: BANK2.
		OFF	
		ON	
Inner trig	—		Each time that the SET button is pressed, the trigger will be turned on or off. The condition to enable this function is: IN3: BANK3.
		N.O.	The trigger turns on when input is applied.
		N.C.	The trigger turns off when input is applied.
Input polar	N		Set the operation polarity of the external input terminals.
		N.O.	The trigger turns on when input is applied.
		N.C.	The trigger turns off when input is applied.
Trig action	Y		Set the measurement operation to perform when trigger input is received.
		Cont	Measurements will be performed continuously.
		1shot	One measurement will be performed when trigger input is received.
		Count	When the predetermined number of trigger inputs are received, one measurement will be performed see Trig count.
Trig count	Y		Set the count to use when “Trig action” is set to “Count.” The condition to enable this function is: Trig action: Count.
		1 to 4095 [1]	[Unit: Number of times]
Inp filter	N		Set the external input filter time to prevent chattering.
		5 to 1275 [5]	[Unit: µs] * You can set this value in steps of 5 µs.
Trig delay	Y		Set the delay time between the trigger meeting the camera conditions and the camera actually taking images.
		5 to 20475 [5]	[Unit: µs] * You can set this value in steps of 5 µs.
Offset target	N		Select the target on which to execute the offset. The condition to enable this function is: IN4: Offset.
		Indivi	Depending on the input time, the offset will be executed on or cleared from OUT1, OUT2, or OUT3 or on all of these.
		All	The offset will be executed on or cleared from all of OUT1, OUT2, and OUT3.
		OUT1	The offset will be executed on or cleared from OUT1.
		OUT2	The offset will be executed on or cleared from OUT2.
		OUT3	The offset will be executed on or cleared from OUT3.

5.2.3 Storage

Configure the settings related to the storage function.

Serial communication or PRO2-navigator is required to check stored data.

Operating the Sensor

Setting item	Bank	Setting value/ default value	General description
Storage	N		Select data for storage.
		OFF	Storage not performed.
		Measure	Stores measurement values.
		Profile	Stores profile and measurement values.
No.of Data	N		Set the number of data saved starting from the start position.
		1 to 65535 [1000]	The upper limit is 8000 when storing a profile.
Start cond	N		Used to select storage start conditions.
		Continue	Storage always executed.
		Hold in	Starts storage operation on a Hold start of the external input terminal.
		Measure	Storage starts from the point that the specified measurement target becomes measurable.
		Alarm	Storage starts from the instant that the specified measurement target becomes not measurable.
		UP limit	Storage starts from the point that the specified measurement target exceeds the threshold.
		LOW limit	Storage starts from the point that the specified measurement target falls below the threshold.
Start pos	N		Set the storage start position for the trigger.
		-10000 to +10000 [0]	[Unit: Number of samplings] Using 0 as reference, a negative value indicates a previous position (pre-trigger) while a positive value indicates a subsequent position (delay trigger). When the storage target is profile, the value can be set in a range of -2000 to +2000.
Start target	N		Used to select the target of the storage start condition. The condition to enable this function is: Start cond: Measure, Alarm, UP limit, or LOW limit
		Area1	Storage starts based on an area 1 value.
		Area2	Storage starts based on an area 2 value.
		Area3	Storage starts based on an area 3 value.
		Area4	Storage starts based on an area 4 value.
		Calc1	Storage starts based on a calculation 1 value.
		Calc2	Storage starts based on a calculation 2 value.
Threshold	N		Set the threshold when "UP limit" or "LOW limit" is selected for "Start cond". The condition to enable this function is: Start cond: UP limit, LOW limit
		-999.999 to +999.999 [0]	
Intermit- tent	N		Data storage interval. All data is stored when the setting value is "0".
		0 to 8191 [10]	[Unit: Number of samplings]

Setting item	Bank	Setting value/ <u>default value</u>	General description
Repeat	N		Set the behavior when the number of storage data items reaches the upper limit.
		ON	Returns to the top and updates data, overwriting with the new data.
		OFF	Storage stops at the point that the upper limit value is reached. The storage target automatically changes to "OFF".
		Pause	When the storage start condition is met, storage starts up to the limit and hold until the start condition is met and so on. Once after storing up to the limit, it overwrite with new data.

Reference: For details on the camera settings, see "7.3 Storage Settings."

Operating the Sensor

5.2.4 Other

Setting item	Bank	Setting value/ default value	General description
Bank switch	N		Select how to change between banks.
		In/Para	Sensor operations or the input terminals will be used to change between banks.
		Comm	Communication (including PRO2-Navigator) will be used to change between banks.
Bank	N		Change the bank. The display details vary depending on the settings of the input terminals. The bank is determined by the details of this setting and the status of the input terminals. The condition to enable this function is: Bank switch: In/Para.
		Input terminal settings	IN1: BANK1 IN2: BANK2 IN3: BANK3
		—	You cannot switch the bank from the sensor.
		Input terminal settings	Reset IN2: BANK2 IN3: BANK3
		1, 3, 5, 7	The bank is changed to number 1, 3, 5, or 7.
		2, 4, 6, 8	The bank is changed to number 2, 4, 6, or 8.
		Input terminal settings	IN1: Reset IN2: Hold IN3: BANK3
		1, 5	The bank is changed to number 1 or 5.
		2, 6	The bank is changed to number 2 or 6.
		3, 7	The bank is changed to number 3 or 7.
		4, 8	The bank is changed to number 4 or 8.
		Input terminal settings	IN1: BANK1 IN2: BANK2 IN3: Trigger
		1, 2, 3, 4	The bank is changed to number 1, 2, 3, or 4.
		5, 6, 7, 8	The bank is changed to number 5, 6, 7, or 8.
		Input terminal settings	IN1: Reset IN2: BANK2 IN3: Trigger
		1, 3	The bank is changed to number 1 or 3.
		2, 4	The bank is changed to number 2 or 4.
		5, 7	The bank is changed to number 5 or 7.
		6, 8	The bank is changed to number 6 or 8.
		Input terminal settings	IN1: BANK1 IN2: Hold IN3: Trigger
		1, 2	The bank is changed to number 1 or 2.
		3, 4	The bank is changed to number 3 or 4.

Setting item	Bank	Setting value/ default value	General description
		5, 6	The bank is changed to number 5 or 6.
		7, 8	The bank is changed to number 7 or 8.
		Input terminal settings	IN1: Reset IN2: Hold IN3: Trigger
		<u>1</u>	The bank is changed to number 1.
		2	The bank is changed to number 2.
		3	The bank is changed to number 3.
		4	The bank is changed to number 4.
		5	The bank is changed to number 5.
		6	The bank is changed to number 6.
		7	The bank is changed to number 7.
8	The bank is changed to number 8.		
Baud rate	N	Select the communication baud rate.	
		9.6K	9,600 bps
		19.2K	19,200 bps
		38.4K	38,400 bps
		57.6K	57,600 bps
		115K	115,000 bps
		230K	230,000 bps
		460K	460,000 bps
		921K	921,000 bps
		<u>2.0M</u>	2.0 Mbps
		4.0M	4.0 Mbps
Axis dir	N	Set the increase/decrease direction of the measured value height with the measurement center set as 0 mm.	
		Near+	Set the side close to the head as positive (+).
		<u>Far+</u>	Set the side far from the head as positive (+).
On Timing	N	Set either within range or outside of range (as specified by the thresholds) as output judgment criteria.	
		<u>Out range</u>	Output turns on when the value is outside the range specified by the threshold.
		In range	Output turns on when the value is within the range specified by the threshold.
Lang/言語	N	Select the screen's display language.	
		JPN/日	Information will be displayed in Japanese.
		<u>ENG/英</u>	Information will be displayed in English.

Operating the Sensor

Setting item	Bank	Setting value/ default value	General description
Screen-saver	N	Select the behavior of the display after 30 seconds without any operation.	
		Dark	Make the display backlight dark.
		LCD Off	Turns OFF the display backlight. While the display backlight is OFF, the communication speed will get faster.
Brightness	N	0 to 15 [15]	Adjust the screen's brightness.
Initialize	—	Initialize the setting values to their factory default values.	
		All	Initialize the setting values of all banks and the common settings. When you execute this operation, the sensor will automatically restart.
		Bank	Initialize the setting values of the currently selected bank.
Version	—	Display the version of the sensor. (This information is only displayed.)	

5.3 Setting

This section explains the setting items on the setting screen. The setting screen has three sets of settings: "Camera," "Profile," and "Area." While the setting screen is displayed, judgment output (control output) is stopped and out-of-range analog current output is generated (approximately 24 mA). Table items marked with "Y" in the "Bank" column can be set for each bank. In the same manner, items that have an "N" for their bank are shared between all banks.

5.3.1 Camera

Use the camera settings to configure camera (sampling) conditions such as the camera mode, the camera area, and the exposure condition in order to match the measurement target and environment.

Camera screen

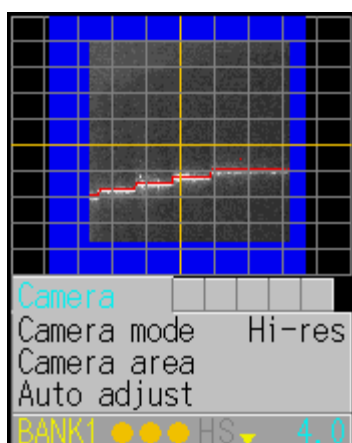

Camera items

You can use the camera settings to configure the following items.

Setting item	Bank	Setting value/ default value	General description
Camera mode	Y	Select the camera mode.	
		Hi-res	All of the pixels will be used by the camera. Image acquisition time: 5 ms (with the maximum image area)
		Hi-spd	Image capture time is reduced to 1/4 of the time in Hi-res mode. Resolution is reduced by half in both the horizontal and vertical directions. Image capture time: 1.25 ms (maximum image area)
		HDR	Screens captured by the camera at two different shutter speeds will be combined. This enables stable measurements of parts that are highly reflective or that are minimally reflective.
		NR	This function eliminates noise by capturing an image with the laser on and another image with the laser off, and then determining the differences between the images.
Camera range	Y	Sets the camera range. The narrower the range, the shorter the imaging time and the sampling period become.	
		— [Entire area]	
Auto adjust	—	Performs an automatic adjustment to set the shutter time to the optimum value. Before you perform the automatic adjustment, set the actual measurement target in place, and do not move the target during the adjustment. When you execute automatic adjustment, "Camera mode" will automatically change to "Hi-res."	
		Wait...	Displays while automatic adjustment is being executed.
Gain	Y	Specify the light reception gain. The larger the number, the higher the gain.	
		1.00	Minimum gain
		1.14	
		1.33	
		1.60	
		2.00	
		2.29	
		2.67	
		3.20	
		4.00	
		5.33	
8.00	Maximum gain		
Shutter	Y	Set the shutter time.	
		5 to 10235 [500]	[Unit: μs] * You can set this value in steps of 5 μs.
HDR shutter	Y	The condition to enable this function is: Camera mode: HDR. Sets the shutter speed to use when "Camera mode" is set to "HDR." This must be set to a value that is greater than the "Shutter" setting value (so that the shutter time is longer). When you set "Camera mode" to "HDR," this is set to a value that is (shutter time × 4).	
		5 to 10235 [1000]	[Unit: μs] * You can set this value in steps of 5 μs.

Operating the Sensor

Setting item	Bank	Setting value/ default value	General description
Threshold	Y	Set the threshold (lower limit) of the light amount at which an alarm is triggered * Normally you do not have to change this setting.	
		0 to 255 [32]	[Unit: Received light amount]
Reject level	Y	Set the ratio to exclude when performing calculations from the received light waveform. * Normally you do not have to change this setting.	
		0 to 127 [16]	[No unit: (n + 1)/128]

Reference: For details on the camera settings, see "7.3 Storage Settings."

5.3.2 Profile

Use the profile settings to configure the conditions for extracting profiles from the camera images. Also, when using the profile position, height, and tilt correction, set correction conditions.

Profile screen

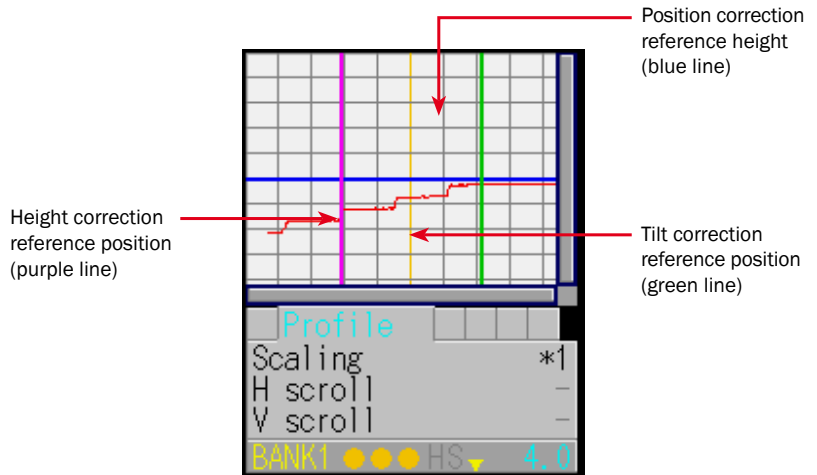

Profile items

You can use the profile settings to configure the following items.

Setting item	Bank	Setting value/ default value	General description
Scaling	Y	Expand or shrink the display range.	
		*1	Display at 100% size. The whole range will be displayed.
		*2	Display at 200% size.
		*4	Display at 400% size.
		*8	Display at 800% size.
		*16	Display at 1600% size.
		*32	Display at 3200% size.
H scroll	Y	—	Move the display position horizontally. When the display range is at 100% size, you cannot move the display position.
V scroll	Y	Wait...	Move the display position vertically. When the display range is at 100% size, you cannot move the display position.
Target	Y	Select the measurement target.	
		Normal	The standard setting to perform measurements.
		Gap	Select this setting when the target has large level differences. The level difference edge precision will be improved.
		Semi-trans	Use this setting when you are measuring resin or other semi-transparent objects.

Operating the Sensor

Setting item	Bank	Setting value/ default value	General description
Alarm limit	Y		Set the number of values (measured values to the right) to maintain when an alarm occurs. When you specify this setting, the specified number of values immediately before the alarm (to the right) will be maintained. If alarms occur repeatedly such that the set number of values is exceeded, an alarm (measured value 7FFF) is triggered.
		0 to 14/HOLD [6]	[Unit: Number of values] * HOLD: Alarm state is not entered.
Smoothing	Y		This function averages the profile in the horizontal (X-axis) direction to make the waveform smoother. [Unit: Number of measurements]
		1	Averaging will not be performed.
		2	
		4	
		8	
		16	
		32	
		64	
128			
Correct method	Y		Select the correction method. To use this function, you have to perform master image registration. Also, when you change this setting, you have to update the master image.
		:	Correction will not be performed.
		→	Position correction will be performed on the basis of the left side.
		←	Position correction will be performed on the basis of the right side.
		↑→	Height correction will be performed, and then position correction (left side) will be performed.
		↑←	Height correction will be performed, and then position correction (right side) will be performed.
H correct	Y		The position of the area at the specified height will be corrected by the difference between the master image and the measured profile. To use this function, you have to perform master image registration. Also, when you change this setting, you have to update the master image.
		-28000 to +28000 [0]	[Unit: X coordinate] * You can set this value in steps of 2.
V correct	Y		The height of the area at the specified position will be corrected by the difference between the master image and the measured profile. To use this function, you have to perform master image registration. Also, when you change this setting, you have to update the master image. The condition to enable this function is: Correct method: ↑→, ↑←, or ↑.
		-15000 to +14998 [-6500]	[Unit: Y coordinate] * You can set this value in steps of 2.
Tilt correct	Y		The profile tilt will be corrected so that the two specified points become level with each other.
		ON/ OFF	—

Setting item	Bank	Setting value/ default value	General description
Tilt cor pos	Y		Set the reference position of the second point to use in tilt correction. The reference position of the first point is the "H correct" reference position. To use this function, you have to perform master image registration. Also, when you change this setting, you have to update the master image. The condition to enable this function is: Tilt correct: ON.
		-14998 to +15000 [0]	[Unit: X coordinate] * You can set this value in steps of 2.
Save master	—		Register the current profile as the master image.
		Wait...	This is displayed when the profile is being registered as the master image.

Reference: For details on the profile settings, see "7.5 Profile Settings."

Operating the Sensor

5.3.3 Area

To switch to the Area screen, select the tab in measurement mode, and then press the  "SET" button.

Area screen

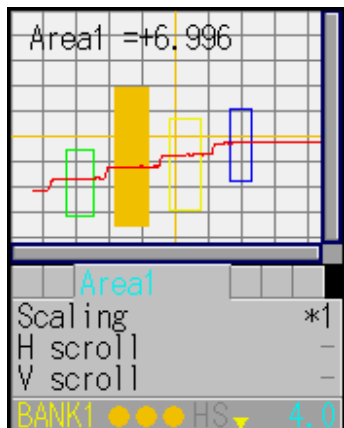

Area items

You can use the area settings to configure the following items.

Setting item	Bank	Setting value/ default value	General description
Scaling	Y		Expand or shrink the display range.
		*1	Display at 100% size. The whole range will be displayed.
		*2	Display at 200% size.
		*4	Display at 400% size.
		*8	Display at 800% size.
		*16	Display at 1600% size.
		*32	Display at 3200% size.
H scroll	Y	—	Move the display position horizontally. When the display range is at 100% size, you cannot move the display position.
V scroll	Y	—	Move the display position vertically. When the display range is at 100% size, you cannot move the display position.
Coverage	Y	—	Set the range of the area.
Meas func	Y		Select the measurement function of the area. The unit is [mm] unless stated otherwise.
		Average	The average of the measured values within the area will be output.
		P height	The largest measured value within the area will be output.
		B height	The smallest measured value within the area will be output.
		Width	The width of the profile that crosses the center of the area will be output.
		P pos	The position of the largest measured value within the area will be output.
B pos	The position of the smallest measured value within the area will be output.		

Setting item	Bank	Setting value/ default value	General description
		Edge pos	The position at which the profile crosses the center of the area will be output.
		EdgeCount	The number of times that the profile crosses the center of the area will be output. [Unit: Number of times]
		Tilt	A straight line approximating the profile will be determined, and then the tilt of this line will be measured. [Unit: Degrees (°)] * Slope rising to the right will be treated as positive.
		Size	The mathematical area of the section bounded by the profile and the area will be determined. [Unit: mm ²]
		Length	The line length of the profile will be determined.
		Diameter	A circle approximating the profile will be determined, and then the diameter of this circle will be output.
		Inflect	The position of the point which is inflecting most will be output.
Edge dir H	Y		Set the direction in which edges will be detected during the “Edge pos” measurement. The condition to enable this function is: Meas func: Edge pos.
		←	Positions will be detected from the right side.
		→	Positions will be detected from the left side.
Direction	Y		Set the direction in which to perform measurements during the “Size” and “Diameter” measurements. The condition to enable this function is: Meas func: Size or Diameter.
		↑	The mathematical area will be measured from the lower side of the area up. Diameter measurements will be made with the top part of the circle as convex.
		↓	The mathematical area will be measured from the top side of the area down. Diameter measurements will be made with the lower part of the circle as convex.
Inflect threshold	Y		Set the threshold value. When detecting inflecting point, it outputs when the inflection reaches to this value. The condition to enable this function is: Meas func: Inflect
		↓-255 ~ +255 [+3]	The polarity means direction of the inflection.
Correction	Y		Select whether to use the set position and height correction with this area.
		OFF	The position and height correction will not be used.
		ON	The position and height correction will be used.

Reference: For details on the area settings, see “7.6 Area Settings.”

5.4 Graph/Calc

The measured results of each area are displayed as a graph. You can also set calculation functions for adding or subtracting area measured results.

You can set up to two calculation formulas in the format **(calculation target 1) (operator) (calculation target 2)**.

Example: If calculation target 1 is “area 1,” calculation target 2 is “area 2,” and the operator is “+,” the calculation formula will be: **(area 1) + (area 2)**.

Table items marked with “Y” in the “Bank” column can be set for each bank. In the same manner, items that have an “N” for their bank are shared between all banks.

Graph/Calc screen

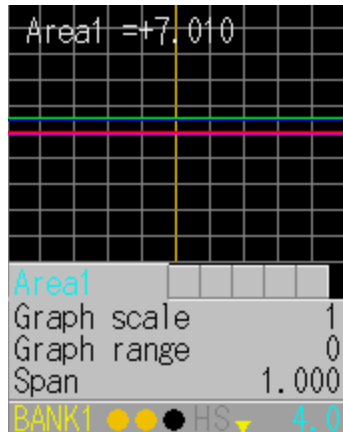

Reference: See “7.7 Calculation Settings.”

5.4.1 Graph Items (Area 1 to area 4)

You can use the graph display settings to configure the following items.

Setting item	Bank	Setting value/ default value	General description
Graph scale	Y	Expand or shrink the display time axis (the horizontal axis).	
		1 to 6 [1]	
Graph range	Y	Expand or shrink the measured value display range (the vertical axis).	
		0 to 6 [0]	
Span	Y	Set a span (multiplier) on the measured values.	
		0.001 to 1.999 [1.000]	
Average	Y	Set the number of times over which to perform the moving average of the measured values.	
		1 to 1023 [32]	[Unit: Number of times]
Hold	Y	Select the measured result hold operation.	
		None	The measured result will be output as-is. (Hold input will be ignored.)
		Sample	The measured value during hold input will be output.
		Peak	The maximum value during the hold input period will be output.
		Bottom	The minimum value during the hold input period will be output.

Reference: For details on the graph display settings, see "7.7 Calculation Settings."

Operating the Sensor

5.4.2 Calc Items (Calculation 1 and calculation 2)

You can use the area calculation settings to configure the following items.

Setting item	Bank	Setting value/ default value	General description
Graph scale	Y	Expand or shrink the display time axis (the horizontal axis).	
		1 to 6 [1]	
Graph range	Y	Expand or shrink the measured value display range (the vertical axis).	
		0 to 6 [0]	
Span	Y	Set a span (multiplier) on the measured values.	
		0.001 to 1.999 [1.000]	
Hold	Y	Select the measured result hold operation.	
		None	The measured result will be output as-is. (Hold input will be ignored.)
		Sample	The measured value during hold input will be output.
		Peak	The maximum value during the hold input period will be output.
		Bottom	The minimum value during the hold input period will be output.
Calc target1	Y	Select the area for calculation target 1.	
		Area1	
		Area2	
		Area3	
		Area4	
Operator	Y	Select the operator of the calculation formula.	
		±	Calculation target 1 + calculation target 2
		-	Calculation target 1 - calculation target 2
Calc target2	Y	Select the area for calculation target 2.	
		Area1	
		Area2	
		Area3	
		Area4	

Reference: For details on the graph display settings, see “7.7 Calculation Settings.”

5.5 Output

Use the output display to view the current output status and to set the judgment and analog outputs.
Table items marked with “Y” in the “Bank” column can be set for each bank. In the same manner, items that have an “N” for their bank are shared between all banks.

Output screen

When within the range specified by the thresholds: Green
When outside the range specified by the thresholds: Red

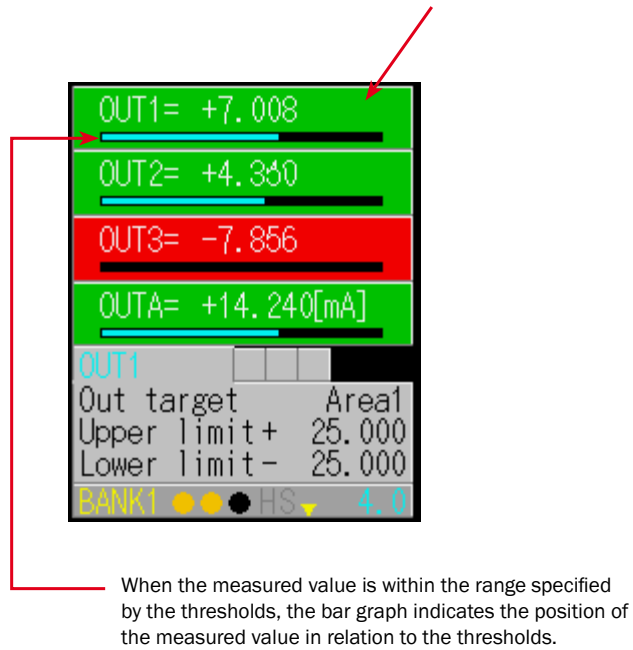

When the measured value is within the range specified by the thresholds, the bar graph indicates the position of the measured value in relation to the thresholds.

- Tips:*
- The background colors of the output screen indicate the judgment results corresponding to the current measured results.
 - The output display in the lower part of the screen indicates the current output status, so the background color and the output color may not match.

5.5.1 Output Items (OUT1 to OUT3)

When the OUT1, OUT2, or OUT3 tab is selected, you can use the output display settings to configure the following items.

Setting item	Bank	Setting value/ default value	General description
Out target	Y	Select the area or calculation to set as the output target.	
		Area1	The measured result of area 1 will be output.
		Area2	The measured result of area 2 will be output.
		Area3	The measured result of area 3 will be output.
		Area4	The measured result of area 4 will be output.
		Calc1	The result of calculation 1 will be output.
		Calc2	The result of calculation 2 will be output.
Upper limit	Y	Set the upper limit of control output.	
		-32.766 to +32.767 [+25.000]	* The unit varies depending on the measurement function. * The displayed value includes the "Offset value" setting.
Lower limit	Y	Set the lower limit of control output.	
		-32.767 to +32.766 [-25.000]	* The unit varies depending on the measurement function. * The displayed value includes the "Offset value" setting.
Out action	Y	Select the operation to perform during output.	
		Normal	The normal on/off output will be performed.
		1shot	Each time that output is turned on, one-shot output will be performed.
		OnDelay	When the output is turned on, output will be performed after a delay elapses.
		Ready	When trigger input is possible, output will be performed.
		Strobe	When the measured value is updated, one-shot output will be performed.
		1shot2	When the measurement result exceeds the upper limit or lower limit, the output will be turned on. Output turns off (open state) in the trigger standby state.
Out polar	Y	Select the polarity to use for output.	
		N.O.	When the measurement result exceeds the upper limit or lower limit, the output will be turned on. Output turns off (open state) in the trigger standby state.
		N.C.	When the measurement result is within the range defined by the upper limit and lower limit, the output will be turned on. Output turns on (closed state) in the trigger standby state.
Output time	Y	Set the output time. The condition to enable this function is: Out action: 1shot, OnDelay, or Strobe.	
		0.1 to 204.7 [0.1]	[Unit: ms] * You can set this value in steps of 0.1 ms.

Setting item	Bank	Setting value/ default value	General description
Offset value	Y	Set an offset value (value to be added) to the output result display. When the external input "Offset" setting is set to "ON," this offset value will be displayed.	
		-32.767 to +32.767 [0.00]	* The unit varies depending on the measurement function. * You can set this value in steps that are 10 times the value of the minimum display digit.
Hysteresis	Y	To prevent chattering, set the amount that the value can fall below (or exceed) the threshold before the output state changes from the state outside the range specified by the thresholds.	
		0 / 4 / 8 / 16 / 32 / 50 / 75 / 100 / 150 / 200 / 300 / 500 / 750 / 1000 / 1500 / 2000 [0]	* The unit varies depending on the measurement function.
Offset	Y	A value will be added to or subtracted from the measured value so that the display value equals the "Offset value" setting. For example, if the offset value is "0," the display will be "0" when the offset operation is performed. When measurement is not possible, offset input will be ignored.	
		OFF	The offset will be cleared.
		ON	The offset operation will be performed.

Reference: For details on the output display settings, see "7.8 Output Settings."

5.5.2 Output Items (OUTA)

When the OUTA tab is selected, you can use the output display settings to configure the following items.

Setting item	Bank	Setting value/ default value	General description
Out target	Y	Select the area or calculation to set as the output target.	
		Area1	The measured result of area 1 will be output.
		Area2	The measured result of area 2 will be output.
		Area3	The measured result of area 3 will be output.
		Area4	The measured result of area 4 will be output.
		Calc1	The result of calculation 1 will be output.
		Calc2	The result of calculation 2 will be output.
20mA	Y	Set the upper limit of analog output.	
		-31.767 to +32.767 [+25.000]	* The unit varies depending on the measurement function.
4mA	Y	Set the lower limit of analog output.	
		-32.767 to +31.767 [-25.000]	* The unit varies depending on the measurement function.

Tips: • Set the “20mA” and “4mA” input values so that they meet the following conditions.

- If the following conditions are not met, analog output will not be performed correctly.
 - The “20mA” input value must be greater than the “4mA” input value.
 - The difference between the “20mA” and “4mA” input values must be 1.000 or more.

Reference: For details on the output display settings, see “7.8 Output Settings.”

6 PR02-Navigator Setup Software

6.1 Setup Software Requirements

6.1.1 Operating Environment

The operating environment for this software is shown below.

Item	Details
Computer	A computer running Windows®
Base OS	Microsoft® Windows XP® Microsoft® Windows 7®
Memory	512 MB or more
Hard disk	100 MB or more

PRO2-Navigator Setup Software

6.2 Software Setup

6.2.1 Installing the Driver

This section explains the device driver installation procedure.

- Tips:**
- Before performing the installation, exit all other applications that are running on Windows®
 - Log in as a user with Administrator rights before installation.

1. Insert the setup software user's manual USB flash drive.
2. Double-click the USB flash drive icon to open it.
3. Start the driver installation. Double-click "CDM v2.xx.xx WHQL Certified.exe." The "FTDChip CDM Drivers" screen displays.

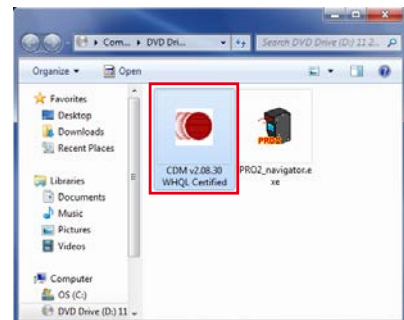

4. Open the "Device Driver Installation Wizard."
Click [Extract].

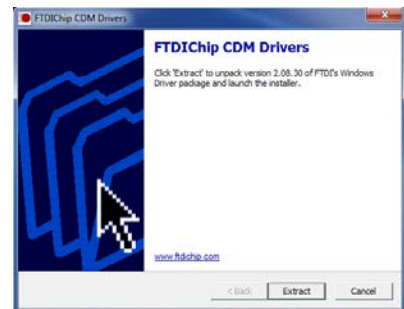

5. Proceed with the driver installation.
Click [Next].

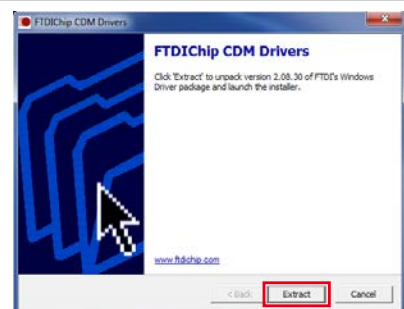

6. Complete the driver installation.
Click [Finish].
This completes the driver installation.

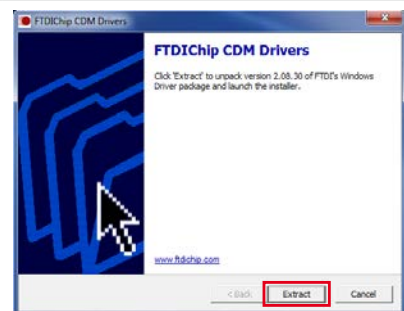

6.2.2 Install the Software

This section explains the setup software installation procedure.

1. Insert the setup software user's manual USB flash drive.
2. Double-click the USB flash drive icon to open it.
3. Create a folder on your computer to save the PRO2-Navigator setup software.
4. Copy the "PRO2_navigator.exe" file to the folder you created.

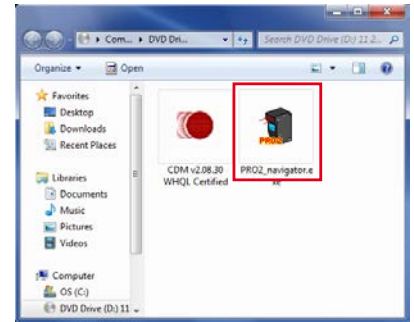

5. Start the setup software.
Double-click the copied "PRO2_navigator.exe" file.
Setup software PRO2-Navigator starts.

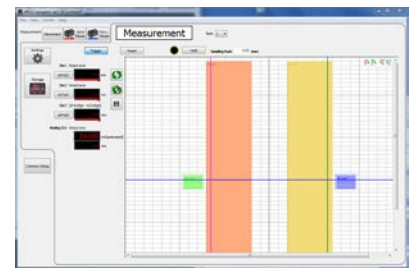

6. Exit the setup software.
After setup software PRO2-Navigator has started normally,
on the "File" menu, click "eXit" or click the close button in the
upper-right corner of the screen to exit the program.

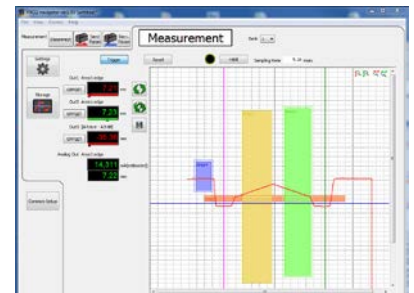

6.2.3 Settings for High-speed Communication

To enable high-speed communication with the PRO2, we recommend that you configure the settings of the communications port. Change the “Latency Timer” setting to 1. Please refer to the operation instructions of your Base OS. However this setting will increase load on the computer during communication. If operation becomes unstable, return the settings to their previous values.

Uninstallation Procedure

Tips:

- Exit the setup software before uninstalling.

-
- Delete the entire folder where the “PRO2-Navigator” install file is saved.
-

6.3 PRO2-Navigator Screen and Operating

6.3.1 Start PRO2-Navigator





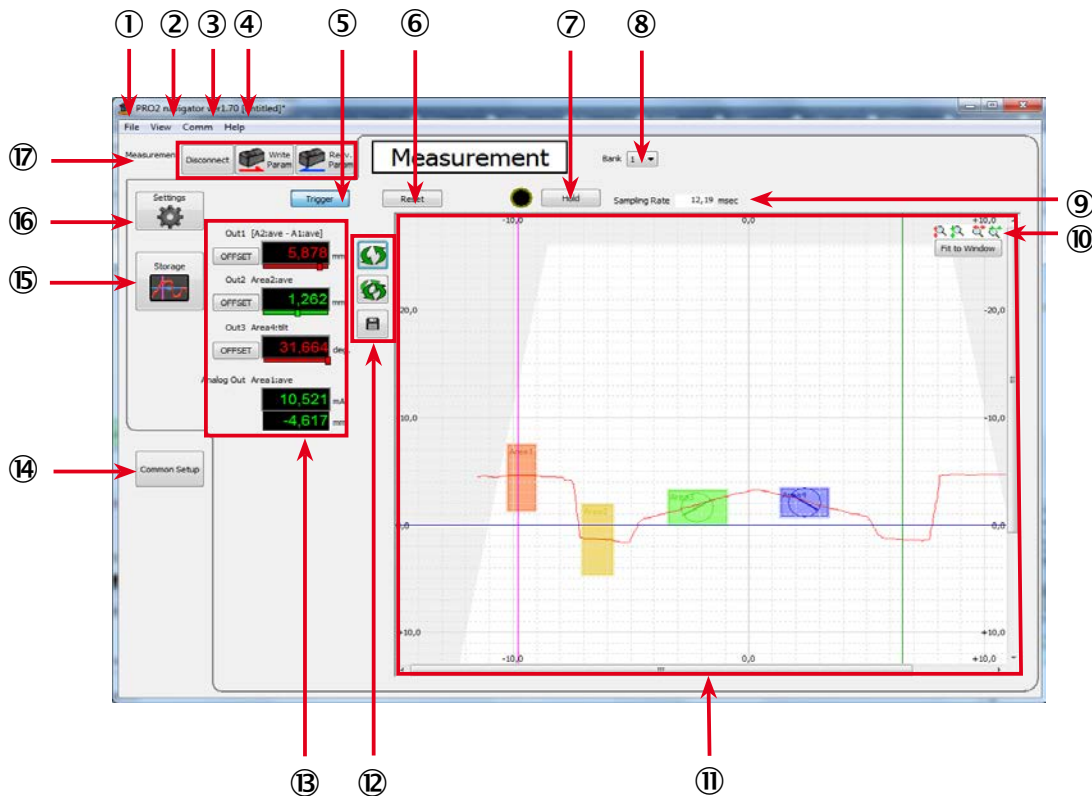

Double-click the icon to start the program.

6.3.2 Main Screen (Measurement Screen)

This section explains the details of the main screen (measurement screen).



Number	Display item	Description	Operation
①	File	Display the File menu.	<ul style="list-style-type: none"> New: Creates a new settings file. Open: Displays the "Open File" dialog box, to open an existing file. Save: Displays the "Save As" dialog box, to save the current settings to a file. eXit: Exit PRO2-Navigator.
②	View	Display the View menu.	<ul style="list-style-type: none"> Measure: Displays the measurement screen. Settings: Displays the "Inputs/Trigger," "Camera," "Profile," "Area," "Operation," or "Outputs" setting screen. Common Settings: Displays the common screen.

Number	Display item	Description	Operation
③	Comm	Display the Comm menu.	<ul style="list-style-type: none"> • Send Param Sends communication settings to the sensor head. • Receive Param Receives communication settings from the sensor head. • Connect Connect to the sensor head. • Disconnect Disconnect from the sensor head.
④	Help	Display the Help menu.	<ul style="list-style-type: none"> • About 'PRO2-Navigator' Display the software version information.
⑤	Trigger	Turn trigger operation on or off.	Click to switch the trigger between on and off.
⑥	Reset	Reset the measured value.	Click to reset.
⑦	Hold	Turn the hold operation on or off.	Each click of the button switches the hold operation between on and off. On/off status is indicated by the lit status of the icon.
⑧	Bank	Switch the bank.	Select the bank number from "1" to "8." When you change this setting, "Bank switch" automatically changes to "Comm."
⑨	Sampling period	Display the sampling period.	—
⑩	Scaling	Expand or shrink the display area.	 Expand the display area in the vertical direction.  Shrink the display area in the vertical direction.  Expand the display area in the horizontal direction.  Shrink the display area in the horizontal direction.
⑪	Display area	Display the profile.	—
⑫	Command buttons	Set the Measurement screen.	 Update: Update the profile display once.  Continuous update: Continuously update the profile display.  Save: Save the displayed profile data to a .csv file
⑬	Output display	Display status of "Out1," "Out2," "Out3," and "Analog Out".	OFFSET Execute the offset on or clear the offset from the target output.
⑭	Common Setup	Display the Common Setup screen.	
⑮	Storage	Display the storage function setup and execution screen.	
⑯	Settings	Display the Measurement Setup screen.	
⑰	Connect, Disconnect, Send Param, and Recv. Param	Connect or disconnect the sensor head and the computer.	Click to connect the sensor head and the computer. If the connection fails, a confirmation dialog box will display, and you will be switched to the Common Setup screen. When a connection is established, the "Disconnect," "Send Param," and "Recv. Param" buttons display.

6.3.3 Common Setup

This section explains the details of the common setup screen.

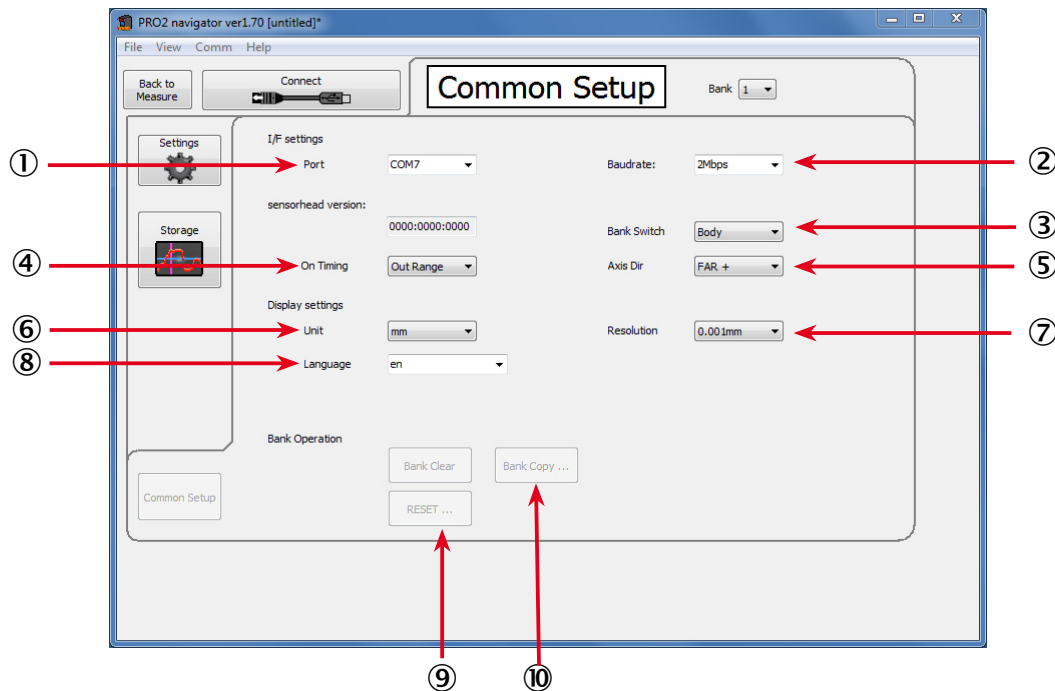

Number	Display item	Description	Operation
①	Port	Set the port to use for communication between the sensor head and the computer.	Select from the list the port to use for communication. The ports that are currently connected to the computer are displayed automatically.
②	Baudrate	Set the communication baud rate.	Select from "9600bps," "19.2kbps," "38.4kbps," "57.6kbps," "115kbps," "230kbps," "460kbps," "921kbps," "2Mbps," and "4Mbps." (The default value of the sensor is "2Mbps.")
③	Bank Switch	Select how to switch between banks.	Select the bank switch method from "Body" and "Comm." If you use "PRO2-Navigator." to switch the bank, this setting will automatically be changed to "Comm."
④	On Timing	Set the output behavior.	Select the output ON/OFF behavior for "Out Range" or "In Range". Detailed explanations are at [7.8.1 Out target.].
⑤	Axis Dir	Set the direction in z-axis to increase and decrease the height direction value.	Select which side's values to use as positive with the measurement center used as the center.
⑥	Unit	Set the measured result display unit.	Select the display unit from "mm" and "µm."
⑦	Resolution	Set the number of digits of the measured result to display.	Select from "1mm," "0.1mm," "0.01mm," and "0.001mm."
⑧	Language	Set the display language of "PRO2-Navigator."	Select the display language of "PRO2-Navigator." You can select from "en" (English), "cn" (Chinese Simplified), "ko" (Korean) and "ja" (Japanese). (Even if you change this setting, the sensor display will not be changed.)

PRO2-Navigator Setup Software

Number	Display item	Description	Operation
⑨	Reset	Click this button to initialize the settings.	<p>“Bank Clear:” Click this button to initialize the settings of the current bank.</p> <p>“Reset:” Click this button to return all the settings to their factory default values. When you execute this operation, the sensor will restart, so communication will be disconnected.</p>
⑩	Bank Copy	Click this button to copy the details of the selected bank.	Click this button to copy the bank settings to a different bank. When you click this button, a setup menu for selecting the copy source and copy target will be displayed.

6.3.4 How to Change Settings

Writing settings

Setting changes are immediately applied to operation, but the changed details are cleared when the power is turned off. You can confirm the changed settings by clicking “Send Param” in the upper left of the screen.

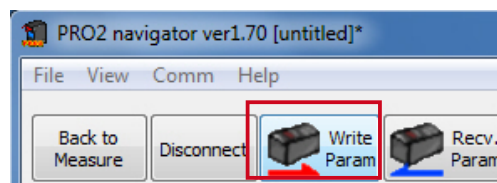

Alternatively, you can confirm the settings when configuring measurement settings by clicking “Send PARAM” in the bottom right of the “Outputs” setup screen.

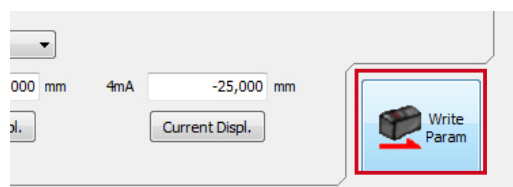

If you attempt to exit the software without first confirming the settings, a confirmation dialog box will be displayed.

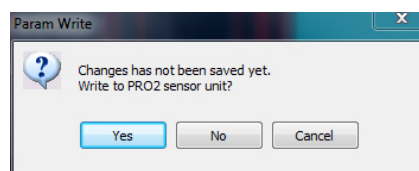

6.4 Setup Procedure

6.4.1 Connecting to the Sensor Head

When the sensor head and computer are connected, click “Connect” to connect to the sensor head and automatically update the measured value.

If the connection fails, the message “Failed to connect to Profiler 2 unit.” will be displayed. When you close the message, the common setup screen will be displayed.

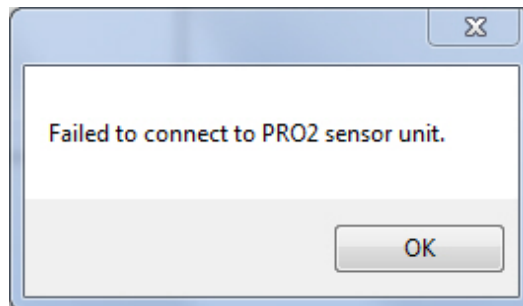

Select the port that is connected to the sensor head and the communication speed, and then click “Connect” again.

After you have established a connection between the sensor head and the computer, configure the measurement settings with the sensor head. Click “Settings” to switch to the “Input/Trigger” screen. Click the tabs on the left side of the screen in the order shown to set each item.

Reference: For details on the measurement settings, see the following sections.

- *6.4.2 Input/Trigger Settings*
- *6.4.3 Camera Settings*
- *6.4.4 Profile Settings*
- *6.4.5 Area Settings*
- *6.4.6 Calculation Settings*
- *6.4.7 Output Settings*

6.4.2 Input/Trigger Settings

This section explains the details of the camera setup screen.

Reference: For details on the input/trigger settings, see “7.2 Input/Trigger Settings.”

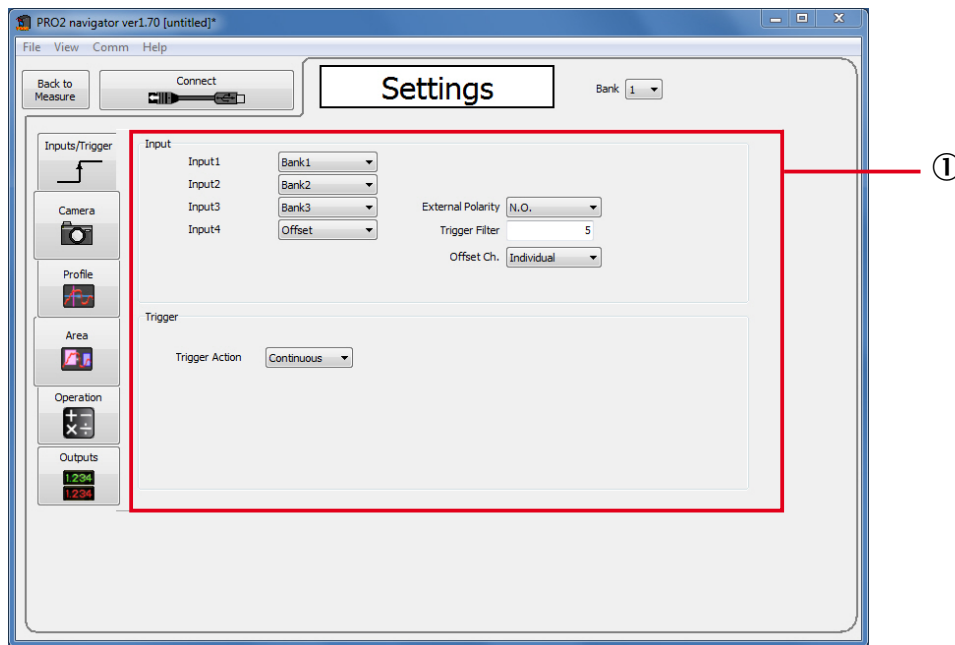





Number	Display item	Description	Operation
①	Input/trigger settings	Configure various settings related to input and triggers.	For each item, select a value from the list or type the value. Items with required input will display based on the settings.

6.4.3 Camera Settings

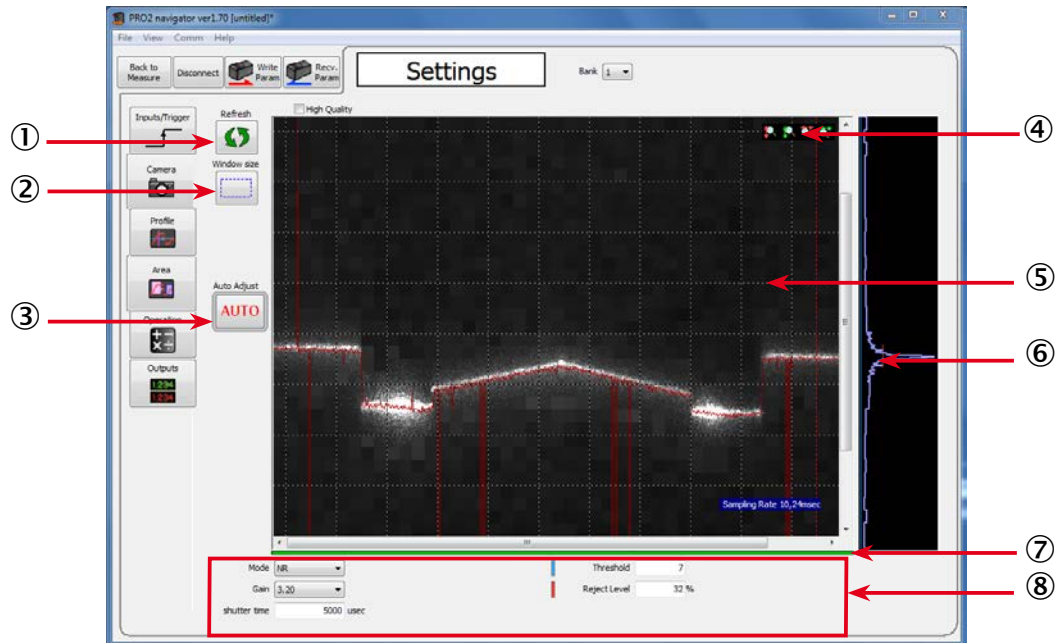
This section explains the details of the camera setup screen.

Reference: For details on the input/trigger settings, see “7.4 Camera Settings.”



Number	Display item	Description	Operation
①	Refresh/Stop	Updates the display area details to the latest status.	When you click Refresh button, the latest camera image is acquired. (If the communication speed is slow, it may take time to acquire the image.) When the STOP button is pressed while the process is on going, the process will be stopped.
②	Window Size	Specifies the camera range. Narrow the range to reduce the time required to capture the image.	When you click this button, a white, square frame indicating the range will be drawn on the camera image ⑥. Adjust the range using the mouse by dragging the sides and corners of the frame.
③	Auto Adjust	Automatically sets the Hi-res or NR mode to the optimum value.	Click this button to automatically set the shutter time. <ul style="list-style-type: none"> • Before automatic adjustment, set the actual measurement target in place and do not move the target during adjustment. (If “Trigger Mode” is set to any value other than “Continuous,” apply the trigger.) • “Hi-res” and “NR-Mode”, “Gain”, “shutter time”, “Threshold” and “Reject Level” will be adjusted automatically by pressing “Auto adjust” button.
④	Scaling	Expand or shrink the display area.	 Expand the display area in the vertical direction.  Shrink the display area in the vertical direction.  Expand the display area in the horizontal direction.  Shrink the display area in the horizontal direction.
⑤	Camera image	Displays the camera image captured when “Refresh” was clicked.	The camera image is displayed here.

Number	Display item	Description	Operation
⑥	Received light waveform	Displays the received light waveform at the position specified on the camera image.	View the received light waveform (dispersion of the amount of received light in the height direction) at a specific position (indicated by the dotted red line) by clicking that position on the camera image. <ul style="list-style-type: none"> • Red: Threshold • Blue: Reject Level
⑦	Image acquisition progress	Shows the progress of image acquisition when "Refresh" is performed.	When "Refresh" is performed, a green bar shows the progress of image acquisition. Image acquisition is complete and the image is updated when the bar reaches the right end.
⑧	Camera settings	Displays the camera settings.	Displays the camera settings. Displays "HDR Shutter" when "Mode" is set to "HDR."

6.4.4 Profile Settings

This section explains the details of the profile setup screen.



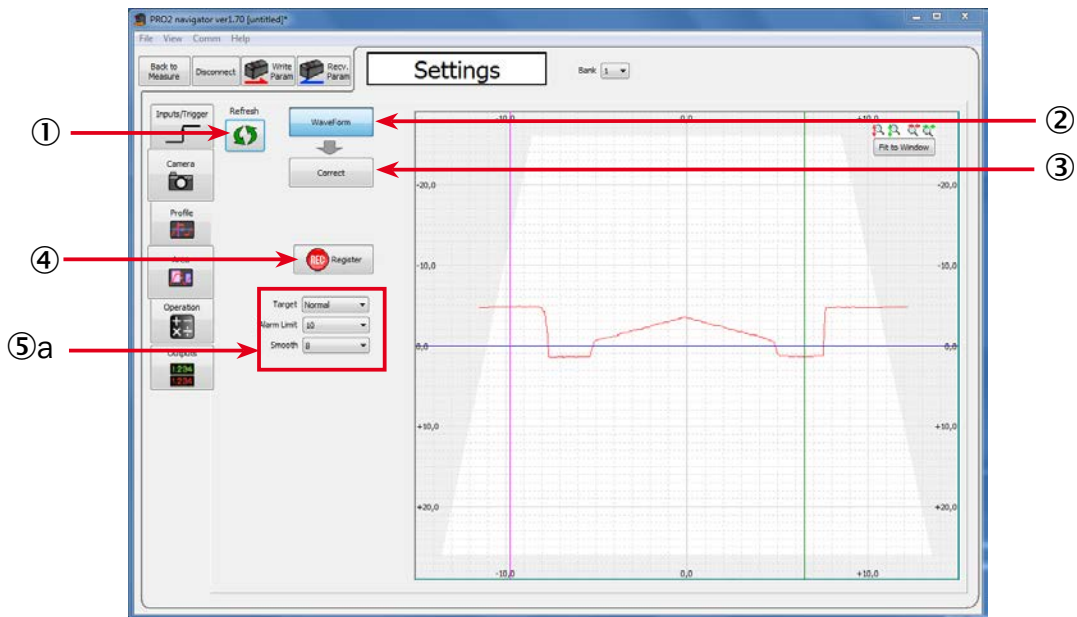

Reference: For details on the profile settings, see “7.5 Profile Settings.”

Setting the waveform extraction

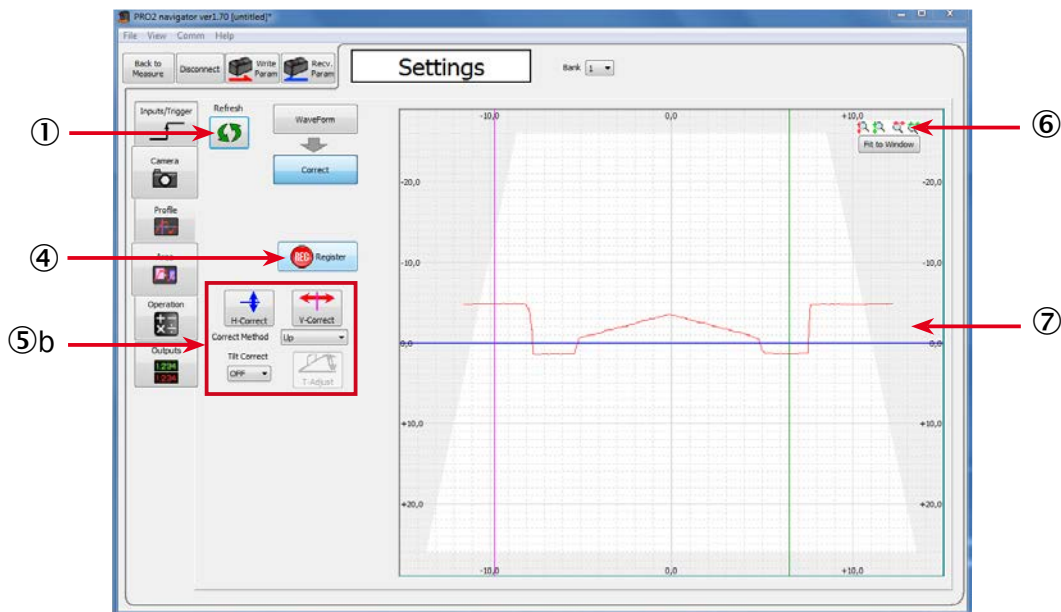

Setting the origin and tilt correction



Number	Display item	Description	Operation
①	Refresh	Updates the profile.	Click this button to update the screen to the latest profile.
②	Waveform	Sets the parameters related to waveform extraction.	Click this button to display the parameters related to waveform extraction ⑤a.
③	Area	Sets the parameters related to position correction, height correction, and tilt correction.	Click this button to display the parameters related to position correction, height correction, and tilt correction ⑤b.
④	Register	Registers the profile as the master image.	Click this button to acquire a new profile and register as the master image. You must register a new master image when you change the correction settings.
⑤a	Profile Settings	Target, alarm limit and smoothing	For details please refer to chapter "7.4.1 Camera Mode."
⑤b	Profile Correction Settings	Position correction, height correction and tilt correction	For details please refer to chapter "7.4.3 Camera Range."
⑥	Scaling	Expand or shrink the display area.	 Expand the display area in the vertical direction.  Shrink the display area in the vertical direction.  Expand the display area in the horizontal direction.  Shrink the display area in the horizontal direction.





Number	Display item	Description	Operation
⑦	Display area	Displays the profile.	Displays the acquired profile. Also, set the reference position and height for each correction. To configure settings, click the button for the correction details whose reference you want to change on the "Area" screen. In this case, you can change the reference position or height of the correction by dragging the corresponding correction to adjust it. You must register the master image again when you change the correction position or height.

6.4.5 Area Settings

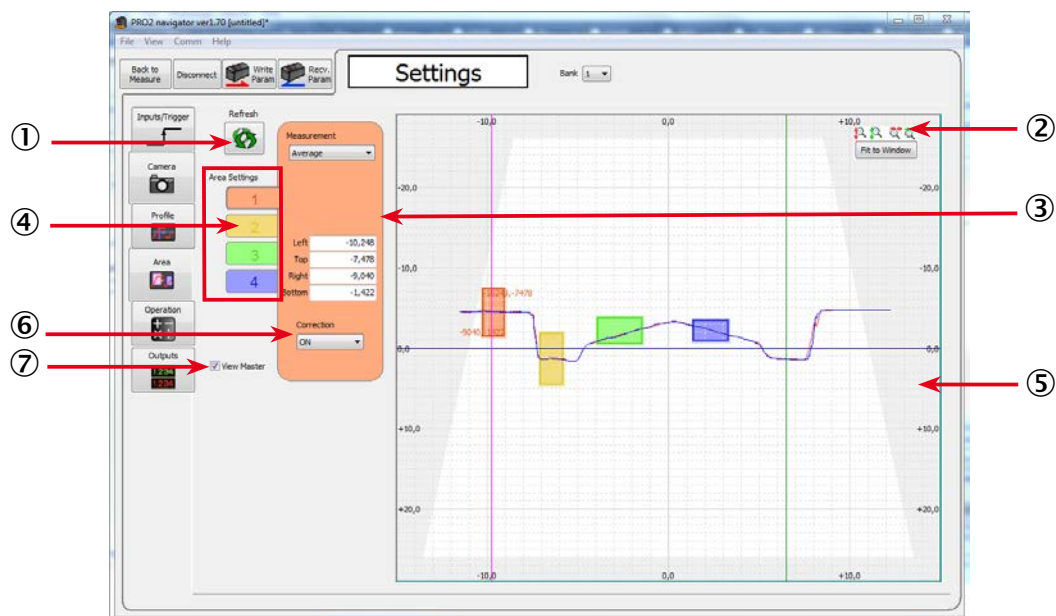
This section explains the details of the area setup screen.

Reference: For details on the area settings, see "7.6 Area Settings."



Number	Display item	Description	Operation
①	Refresh	Click this button to perform continuous updating of the profile.	When you click this button, continuous updating of the profile will start.
②	Scaling	Expand or shrink the display area.	 Expand the display area in the vertical direction.  Shrink the display area in the vertical direction.  Expand the display area in the horizontal direction.  Shrink the display area in the horizontal direction.
③	Measurement	Sets the measurement function of the selected area.	Select the measurement function from the list. Detailed items may be displayed according to the selected function.

PR02-Navigator Setup Software





Number	Display item	Description	Operation
④	Area Settings	Select the area to set.	To select the area that you want to set, click its button.
⑤	Display area	Displays the profile. You can configure areas by dragging them.	Drag the areas to configure them. Expand and shrink areas by dragging their corners and move areas by dragging them (click in the area and then drag it). Click a different area to set that area as the target.
⑥	Correction	Define if you apply correction on this area or not.	<ul style="list-style-type: none"> • OFF The position and height correction will not be used. • ON The position and height correction will be used.
⑦	View master	Define if you want to see the registered master profile or not.	By selecting the check box, the registered profile will be shown in Blue color.

6.4.6 Calculation Settings

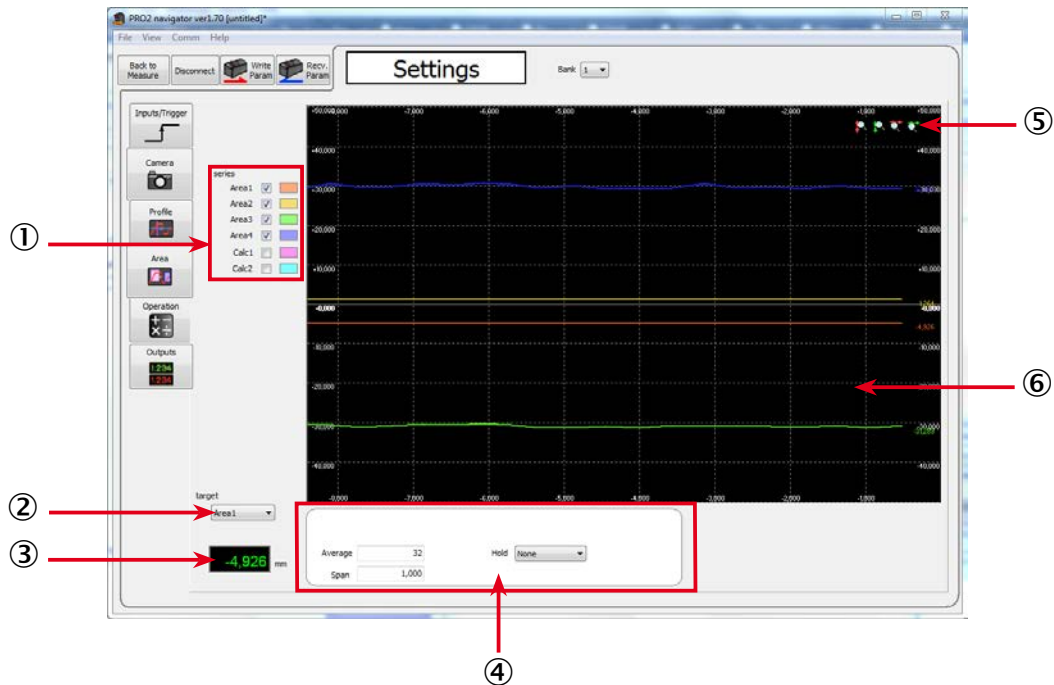
This section explains the details of the calculation setup screen.

Reference: For details on the calculation settings, see “7.7 Calculation Settings.”



Number	Display item	Description	Operation
①	series	Selects the waveform display targets.	The measured values of the areas whose check boxes you select will be displayed on the graph.
②	target	Selects the setting target.	Select the setting target from “Area1,” “Area2,” “Area3,” “Area4,” “Calc1,” and “Calc2.” The details that you can set vary depending on whether the target is an area or a calculation.
③	Measured result	Displays the measured result of the current setting target.	
④	Parameter display area	Displays the settings.	Displays the settings based on the selected details. If you selected “Calc1” or “Calc2” with “target” ②, set the details of the calculation.
⑤	Scaling	Expand or shrink the measured result graph.	 Expand the display area in the vertical direction.  Shrink the display area in the vertical direction.  Expand the display area in the horizontal direction.  Shrink the display area in the horizontal direction.
⑥	Measured result graph	Displays the measured results as a graph.	—

PRO2-Navigator Setup Software

6.4.7 Output Settings

This section explains the details of the output setup screen.

Reference: For details on the output settings, see “7.8 Output Settings.”

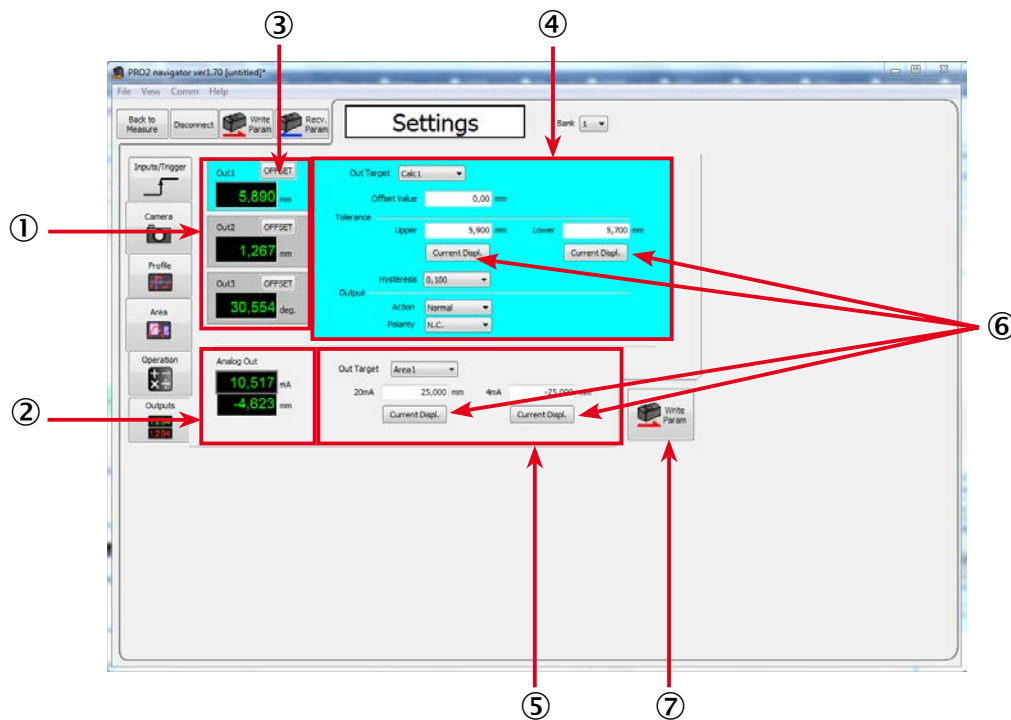

Number	Display item	Description	Operation
①	Output values	Displays the measured results of outputs 1, 2, and 3.	Displays the measured results of the target outputs. Click an output to display its detailed settings ③. The currently selected output is displayed in light blue.
②	Analog Out	Displays the current value of analog output.	Displays the measured result of the analog current output . Displays the analog output current and measured value.
③	OFFSET	Executes the offset on/clear from the specified output (output 1, 2, or 3).	Execute the offset to set the current measured value to the value set with “Offset.” (Example: If “Offset” is set to “0.000,” the current value will become “0.”)
④	Detailed output settings	Displays the detailed output settings of the target.	Displays the detailed settings of the output selected with ①. You can change settings by selecting and typing values.
⑤	Detailed analog output settings	Configure the detailed analog output settings.	Displays the setting values in the input boxes.
⑥	Current Display	Enters the current measured value into the specified item.	Click to enter the current measured value in the target item.
⑦	Send PARAM	Click to finish setting the measurement.	Click to write the setting details to the Profiler 2. (The same operation is performed as when you click “Send Param” in the upper left of the screen.)

6.5 Storage Function

This section explains the screen that you use to access the storage function.

For details on the storage function and storage settings, see “7.3 Storage Settings,”

6.5.1 Storage Settings

This section explains the details of the storage setup screen.

Storage settings are shared between "data storage" and "profile storage."

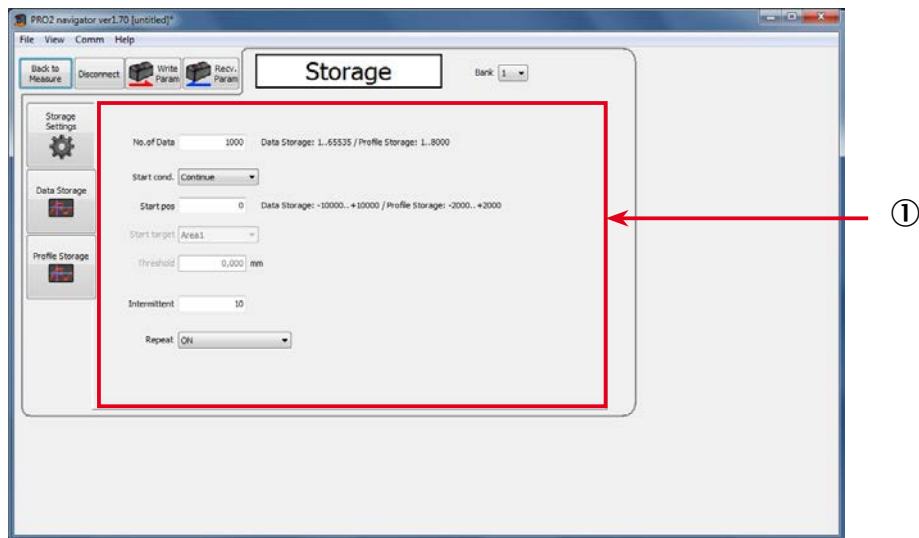





Number	Display item	Description	Operation
①	Storage settings	Configure storage settings.	You can enter different required items according to the setting item.

PRO2-Navigator Setup Software

6.5.2 Data storage

This section explains the details of the data storage screen.



Number	Display item	Description	Operation
①	Start/Stop	Start/stop the storage operation.	Click "Start" to start the storage operation from the beginning. (The saved storage data will be discarded.) The current number of items in storage is displayed under the button.
②	Get	Display the stored data in PRO2-Navigator.	Acquire the stored data from the Profiler 2 main unit and display it in PRO2-Navigator.
③	Save/Read	Save/read storage data.	Save: Save the displayed data to a .csv file. Read: Read saved data. Auto Save: Select this check box to save the result each time that the storage operation is performed.
④	Cursor	Check the measured value at a location on the graph.	Check the measured value and the time from the start at a location on the graph. You can specify up to two cursors, and the difference between the two cursors is calculated automatically.
⑤	Cursor position	Specify the position to acquire the value from.	You can adjust the cursor positions by dragging "A" and "B."
⑥	Graph display	The read data is displayed as a graph.	 Expand the display area in the vertical direction.  Shrink the display area in the vertical direction.  Expand the display area in the horizontal direction.  Shrink the display area in the horizontal direction.



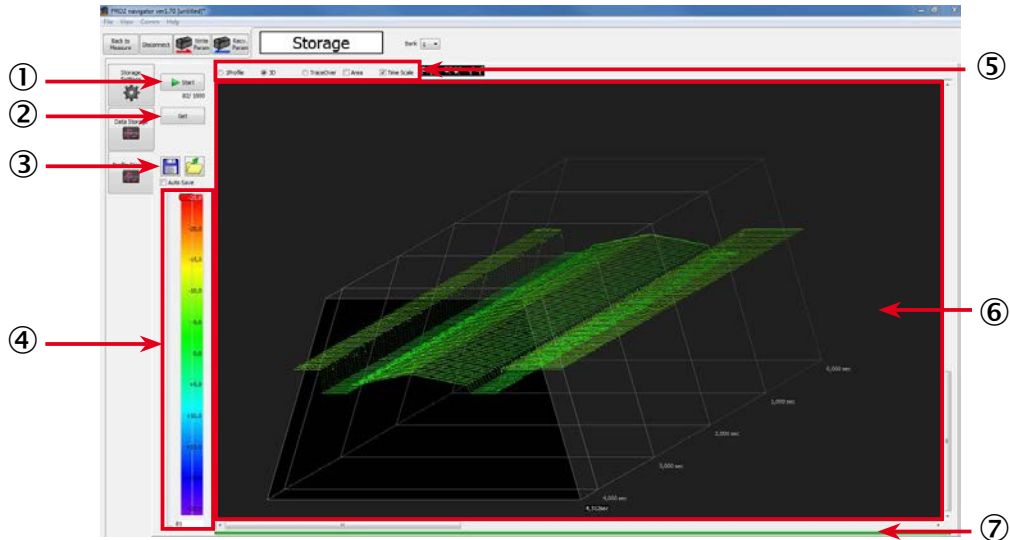

6.5.3 Profile storage

This section explains the details of the profile storage screen. When you switch to the profile storage screen, the data in data storage is discarded.



Number	Display item	Description	Operation
①	Start/Stop	Start/stop the storage operation.	Click "Start" to start the storage operation from the beginning. (The saved storage data will be discarded.) The current number of items in storage is displayed under the button.
②	Get	Display the stored data in PRO2-Navigator.	Acquire the stored data from the Profiler 2 main unit and display it in PRO2-Navigator.
③	Save/Read	Save/read storage data.	Save: Save the displayed data to a .csv file. Read: Read saved data. Auto Save: Select this check box to save the stored profile data automatically after it's stopped.
④	Cursor	The display position of the profile is displayed here.	The color of the profile can be changed by color slide bar depends on the depth measured. Move this slider to change the display range.
⑤	Graph display method	Select the profile display method.	1Profile: Only one profile will be displayed. 3D: Profiles will be shifted to be displayed in a 3D manner. TraceOver: Profiles will be overlaid in the same position. Area: Select this check box to display the position of the area.

PR02-Navigator Setup Software

Number	Display item	Description	Operation
⑥	Graph display	The read data is displayed as a graph.	 Expand the display area in the vertical direction.  Shrink the display area in the vertical direction.  Expand the display area in the horizontal direction.  Shrink the display area in the horizontal direction.
⑦	Progress bar	Displays the progress of data acquisition.	<p>This displays the progress when a profile is being acquired.</p> <p>When the green bar reaches the right side, the acquisition is finished, and the display is updated.</p>

7 Functions

7.1 Settings Lists and Factory Settings

This section contains lists of settings and the corresponding factory settings.

The tables are categorized according to the sensor tabs.

Table items marked with “Y” in the “Bank” column can be set for each bank. Items that have an “N” for their bank are shared between all banks.

Input/Trigger

Item	Bank	Options or setting range	Default value	Reference page
IN1	N	BANK1, Reset	BANK1	[7.2 Input/Trigger Settings]
IN2	N	BANK2, Hold	BANK2	
IN3	N	BANK3, Trigger	BANK3	
IN4	N	Offset, LaserOFF	Offset	
Reset	-	The following measured values will be cleared. <ul style="list-style-type: none"> • The current measured value • The held value 	-	
Inner hold	-	OFF, ON	OFF	
Inner trig	-	OFF, ON	ON	
Input polar	N	N.O., N.C.	N.O.	
Trig action	Y	Cont, 1shot, Count	Cont	
Trig count	Y	1 to 4095 [number of times]	1	
Inp filter	N	5 to 1275 [µs] * In steps of 5 µs	5	
Trig delay	Y	5 to 20475 [µs] * In steps of 5 µs	5	
Offset target	N	Indivi, All, OUT1, OUT2, OUT3	Indivi	

Storage

Item	Bank	Options or setting range	Default value	Reference page
Storage	N	OFF, Measure, Profile	Measure	[7.3 Storage Settings]
No.of Data	N	1 to 65535	1000	
Start cond	N	Continue, Hold in, Measure, Alarm, UP limit, LOW limit	Continue	
Start pos	N	-10000 to +10000	0	
Start target	-	Area1, Area2, Area3, Area4, Calc1, Calc2	Area 1	
Threshold	N	-999.999 to +999.999	0	
Intermittent	N	0 to 8191	10	
Repeat	N	ON, OFF, Pause	ON	

Functions

Other

Item	Bank	Options or setting range	Default value	Reference page
Bank switch	N	In/Para, Comm	In/Para	[7.9 Common Settings]
Bank	N	1, 2, 3, 4, 5, 6, 7, 8	1	
Baud rate	N	9.6K, 19.2K, 38.4K, 57.6K, 115K, 230K, 460K, 921K, 2.0M, 4.0M	2.0M	
Axis dir	N	Near+, Far+	Far+	
On Timing	N	Out range/In range	Out range	
Lang/言語	N	JPN/日, ENG/英	ENG/英	
Brightness	N	0 to 15	15	
Screen Saver	N	Dark/LCD OFF	Dark	
Initialize	-	All, Bank	All	
Ver.	-	The version of the sensor (display only)	-	

Camera

Item	Bank	Options or setting range	Default value	Reference page
Camera mode	Y	Hi-res, Hi-spd, HDR, NR	Hi-res	[7.3 Storage Settings]
Camera area	Y	(Set the area.)	(Entire area)	
Auto adjust	-			
Gain	Y	1.00 to 8.00	1.00	
Shutter	Y	5 to 10235 [μ s] * In steps of 5 μ s	500	
HDR shutter	Y	5 to 10235 [μ s] * In steps of 5 μ s	1000	
Threshold	Y	0 to 255	12	
Reject level	Y	0 to 127	32	

Profile

Item	Bank	Options or setting range	Default value	Reference page
Scaling	Y	*1, *2, *4, *8, *16, *32	*1	[7.5 Profile Settings]
H scroll	Y	(Move the profile horizontally.)	—	
V scroll	Y	(Move the profile vertically.)	—	
Target	Y	Normal, Gap, Semi-trans	Normal	
Alarm limit	Y	0 to 14, HOLD [number of values]	6	
Smoothing	Y	1, 2, 4, 8, 16, 32, 64, 128 [number of measurements]	8	
Correct method	Y	—, →, ←, ↑→, ↑←, ↑	—	
H correct	Y	-28000 to +28000	+0	
V correct	Y	-15000 to +14998	-6500	
Tilt correct	Y	OFF, ON	OFF	
Tilt cor pos	Y	-14998 to +15000	0	
Save master	—	— (Register the latest profile as the master image in the current bank.)	—	

Area

These items are set for each area. You can set up to four areas.

Item	Bank	Options or setting range	Default value	Reference page
Scaling	Y	*1, *2, *4, *8, *16, *32	*1	[7.6 Area Settings]
H scroll	Y	(Move the profile horizontally.)	—	
V scroll	Y	(Move the profile vertically.)	—	
Coverage	Y	(Set the position of the area.)	—	
Meas func	Y	Average, P height, B height, Width, P pos, B pos, Edge pos, EdgeCount, Tilt, Size, Length, Diameter, Infect	(This varies depending on the bank.)	
Edge dir H	Y	←, →	←	
Direction	Y	↑, ↓	↑	
Infect Threshold	Y	-255~ +255	+3	
Correction	Y	OFF, ON	OFF	

Functions

Graph You can configure settings related to the display method of the graph of each area.

Item	Bank	Options or setting range	Default value	Reference page
Graph scale	Y	1 to 6	1	[7.7 Calculation Settings]
Graph range	Y	0 to 6	0	
Span	Y	0.001 to 1.999 [multiplier]	1.000	
Average	Y	1 to 1023 [number of times]	32	
Hold	Y	None, Sample, Peak, Bottom	None	

Calc You can perform calculations between areas.
You can set up to two area calculations.

Item	Bank	Options or setting range	Default value	Reference page
Graph scale	Y	1 to 6	1	[7.7 Calculation Settings]
Graph range	Y	0 to 6	0	
Span	Y	0.001 to 1.999 [multiplier]	1.000	
Hold	Y	None, Sample, Peak, Bottom	None	
Calc target1	Y	Area1, Area2, Area3, Area4	Area1	
Operator	Y	+, -	+	
Calc target2	Y	Area1, Area2, Area3, Area4	Area2	

Output (OUT1 to OUT3) You can configure settings related to the output display.

Item	Bank	Options or setting range	Default value	Reference page
Out target	Y	Area1, Area2, Area3, Area4, Calc1, Calc2	Area1	[7.8 Output Settings]
Upper limit	Y	-32.766 to +32.767	+25.000	
Lower limit	Y	-32.767 to +32.766	-25.000	
Out action	Y	Normal, 1shot, OnDelay, Ready, Strobe, 1shot2	Normal	
Out polar	Y	N.O., N.C.	N.C.	
Output time	Y	0.1 to +204.7 [ms]	0.1	
Offset value	Y	-32.767 to +32.767	0.000	
Hysteresis	Y	0.000 to 2.000	0.000	
Offset	Y	OFF, ON	OFF	

Output (OUTA)

You can configure settings related to analog output.

Item	Bank	Options or setting range	Default value	Reference page
Out target	Y	Area1, Area2, Area3, Area4, Calc1, Calc2	Area1	[7.8 Output Settings]
20mA	Y	-31.767 to +32.767	+25.000	
4mA	Y	-32.767 to +31.767	-25.000	

7.2 Input/Trigger Settings

7.2.1 IN1/IN2/IN3/IN4

Set the operation of the external input terminals. The available selections vary depending on the terminal. IN1, IN2, and IN3 are used as bits 1 to 3 of a binary number that is used to switch the bank. Use the sensor menu to switch the functions of terminals that are not used in bank switching.
(“7.9.1 Banks.” on page 90)

IN1	<ul style="list-style-type: none"> • BANK1: IN1 will be used as the first bit for switching banks. • Reset: IN1 will be used as the reset input terminal.
IN2	<ul style="list-style-type: none"> • BANK2: IN2 will be used as the second bit for switching banks. • Hold: IN2 will be used as the hold input terminal. The set hold operation will be performed for the areas and calculations whose hold settings have been set to “Sample,” “Peak,” or “Bottom” in the Graph/Calc setting (“Calculation settings” in PRO2-Navigator).
IN3	<ul style="list-style-type: none"> • BANK3: IN3 will be used as the third bit for switching banks. • Trigger: IN3 will be used as the trigger input terminal.
IN4	<ul style="list-style-type: none"> • Offset: IN4 will be used as offset input. • LaserOFF: IN4 will be used as the laser emission stop input. Input is used to stop laser emission and measurement.

7.2.2 Reset/Inner hold/Inner trig

Reset	<p>The reset operation is executed from the sensor or from PRO2-Navigator. When you apply the reset input, the following values will be cleared.</p> <ul style="list-style-type: none"> • The current measured value • The measured values up to the current point in time (when the moving average has been set) • The held value • Storage data <p>Also, when a reset input is applied, the output will enter trigger input stand-by state until the measured value is obtained.</p>
Inner hold	<p>Hold is turned on or off from the sensor or from PRO2-Navigator. This is only valid when IN2 is set to “BANK2.”</p>
Inner trig	<p>The trigger is turned on or off from the sensor or from PRO2-Navigator. This is only valid when IN3 is set to “BANK3.”</p>

7.2.3 Input polar, Inp filter

Input polar	<ul style="list-style-type: none"> • N.O.: When input is received through an input terminal, the input terminal turns on. • N.C.: When input is received through an input terminal, the input terminal turns off.
Inp filter	Set the external input filter time to prevent chattering. Set this value in steps of 5 μ s.

7.2.4 Trig action

The Profiler 2 performs a measurement each time that the trigger conditions are met. Set the action of this trigger.

Cont	Imaging and measurements are performed continuously while the trigger is on.
1shot	One measurement is performed when the trigger turns on.
Count	When the trigger has turned on the number of times specified by "Trig count," one measurement is performed. By using an encoder as the trigger, you can perform measurements once per fixed distance.
Trig count	Specifies the number of triggers to use when "Count" is selected for "Trig action."
Trig delay	Sets the delay time between the trigger meeting the camera conditions and the camera actually taking images. Set this value in steps of 5 μ s.

7.2.5 Offset target

Select the target on which to execute the offset when IN4 is set to "Offset."

• Indivi:	You can use the input time to select the target on which to execute the offset.
• All:	The offset is executed on all the outputs.
• OUT1 to OUT3:	The offset is executed on the specified output.

7.3 Storage Settings

The storage function stores measurement results and profile data to the Profiler 2.

Stored data can be output via PRO2-Navigator or RS-485 communication. The "Graph/Calc setting" screen of the Profiler 2 can be used to display stored measured values as a graph.

7.3.1 Storage

Used to select storage contents.

- OFF: Storage function not used.
- Measure: Stores areas 1 to 4 and calculations 1 and 2 measured values.
- Profile: Stores profile data and measured values.

No.of Data

Specifies the number of data stored.

The upper limit for storage data depends on the storage target.

- Measured values: Maximum value 65535
- Profile: Maximum value 8000

7.3.2 Start cond

Specifies conditions for starting the storage operation.

- Continue: Storage operation is always performed.
- Hold in: Storage starts when hold input is performed.
- Measure: Storage starts from the instant that the specified area becomes measurable.
- Alarm: Storage starts from the instant that the specified area becomes not measurable.
- UP limit: Storage starts when the measured value of the specified area exceeds the set threshold.
- LOW limit: Storage starts when the measured value of the specified area falls below the set threshold.

Start pos

Specifies by how much the storage start point should be shifted from the point where the start condition is satisfied.

The unit is number of samplings.

- Positive value: Delays by the specified sampling amount and then starts storage. (Trigger delay)
- 0: Starts storage the instant the condition is satisfied.
- Negative value: Backs up by the specified sampling amount and then starts storage. (Pre-trigger)

Start target

When "Start cond" is "Measure", "Alarm", "UP limit", or "LOW limit", this setting selects which area should be the reference of the start condition. Select from Area1 to 4, or Calc1 or 2.

Threshold

When "Start cond" is "UP limit" or "LOW limit", this setting specifies the threshold to be used as the start condition reference.

7.3.3 Intermittent

Specifies the sampled measurement results and profile storage interval.

0: Stores all acquired data.

1: Repeatedly stores and discards data with each measurement.

The thinning setting affects the storage function only.

Analog output, judgment output, etc. are updated for each sampling.

7.3.4 Repeat

Specifies behavior when the specified number of data items is stored.

ON: Returns to the beginning and overwrites the currently stored data.

OFF: Storage is stopped when the preset number of data items is reached. The storage target automatically changes to OFF.

Pause: When the start condition is fulfilled, storage is proceeded automatically up to the preset number of data items and stops. After that, when the start condition is fulfilled again, it starts storage again from the point it stopped previously. When it reached at upper limit of the storage data, it returns to the beginning and overwrites the currently stored data same as when this setting is "ON".

- Tips:*
- When the area/calculation hold setting is set to other than "None", the calculated storage value will be different from the displayed value.
 - Example: Measured value and storage value operation when the hold setting is "Peak"

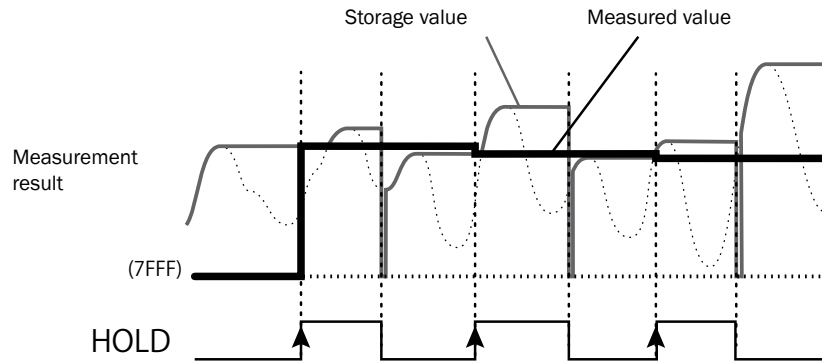

7.4 Camera Settings

7.4.1 Camera Mode

Select the camera mode. For "Hi-res" mode and "Hi-spd" mode, one measurement is performed for each image. For "HDR" mode and "NR" mode, two images are taken by the camera for each trigger, and then one measurement is performed for these two images.

- Tips:*
- After the camera mode is changed, measurements are not performed for the first two triggers.

Camera mode: "Hi-res"

All pixels will be used by the camera to take a high resolution image. Normally use this mode.

Camera mode: "Hi-spd"

Pixels will be averaged in sets of four. Image capture time will be 1/4 but resolution will be half in both the horizontal and vertical directions.

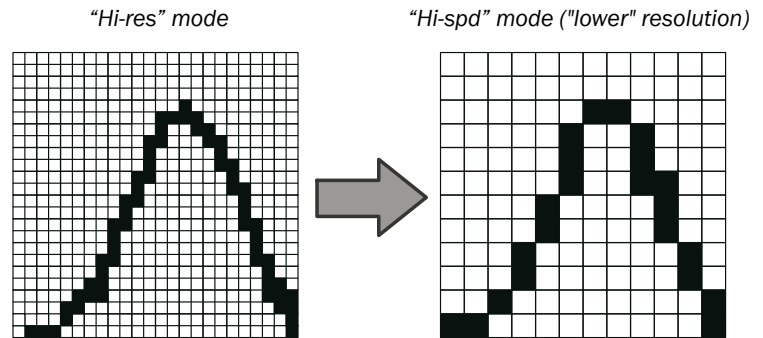

Figure: Difference in resolution attributable to the camera mode (example)

Camera mode: “HDR”

In “HDR” (High Dynamic Range) mode, screens captured by the camera at two different shutter speeds are combined. This makes it possible to perform stable measurements of parts that are highly reflective or that are minimally reflective.

Use this mode when you cannot capture images with a single shutter speed such as for metallic surfaces on circuit boards, very uneven surfaces, or when the surface exhibits large color or profile differences.

- Tips:
- Because two images are taken for each measurement, this mode has a long sampling period.
 - When measuring workpieces that move at a high speed, the HDR image combination may not be performed appropriately.

Functions

Operation of the camera mode

1. Workpieces where HDR is effective

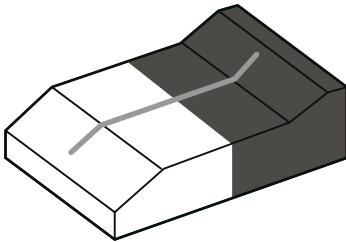

Use this mode when measuring workpieces that have parts whose reflective status vary greatly. The following example uses a workpiece that has a white and a black part, as shown in the figure to the right. To measure this workpiece, it is necessary to acquire a profile like that shown below.



Image example

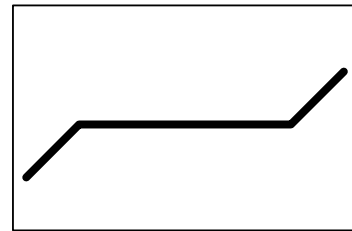

Profile example

2. Problems with the “Hi-res” camera mode

In “Hi-res” mode, if the shutter speed is increased (made shorter), the reflected light from the black part is insufficient to perform the measurement. If the shutter speed is decreased (made longer), the reflected light from the white part is saturated, leading to poor precision.

Fast shutter speed



Image

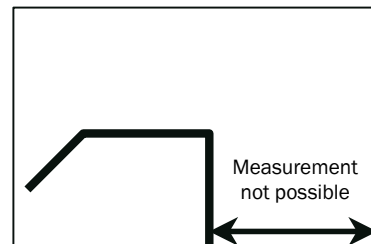

Profile

Slow shutter speed

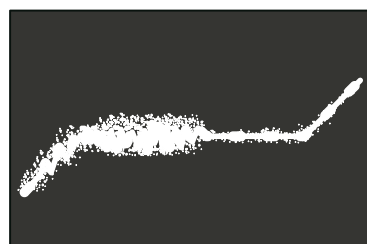

Image

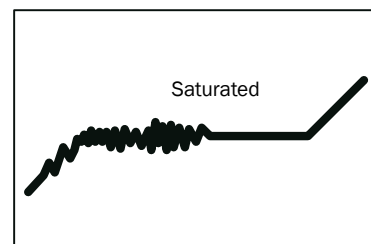

Profile

3. Operation in “HDR” camera mode

In “HDR” mode, the brightness from images captured at fast shutter speeds is amplified. The amplification rate is determined by the ratio of the shutter speeds of the two images.

(Example: If the shutter speeds are 1000 μ s and 4000 μ s, the amplification rate will be $4000/1000 = \times 4$.)

During amplification, areas where the light level is low will be eliminated in advance as noise. (The part marked with the “X” in the following figure.)

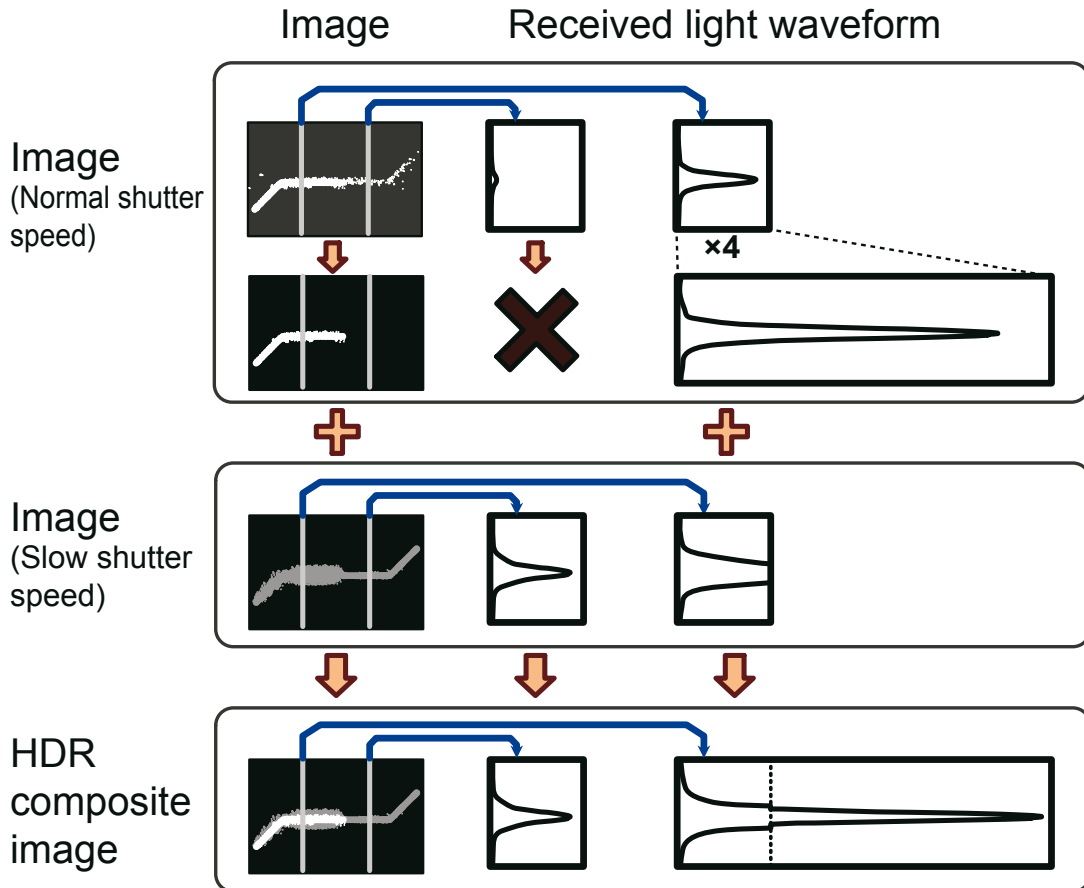

Adding the two images together makes it possible to measure any part of the resultant image with the appropriate amount of light.

Functions

Mandatory settings when using HDR

HDR shutter

In addition to the normal shutter, set the speed of the shutter that will be used to take the image with the slow shutter time. This must be set to a value that is longer than the normal shutter speed. When you select “HDR” mode, this is automatically set to a value that is four times the shutter time.

Camera mode: “NR”

In “NR” (Noise Reduction) camera mode, two images are taken: one when the laser is on and one when the laser is off. Measurement is performed on the difference of these two images. Because the image taken when the laser is off can be canceled, this function is effective in situations where light other than that from the laser – such as noise – has an effect on the measurement. Also, the noise generated during imaging with a high gain can also be canceled.

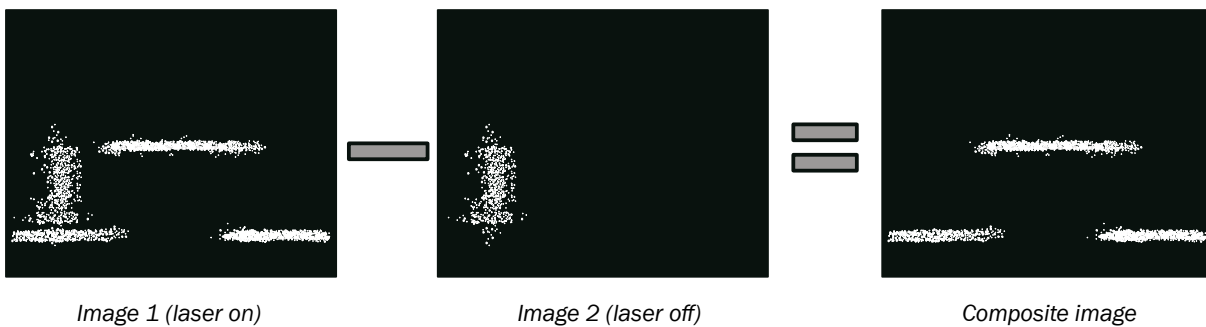

Figure: Example of “NR” mode operation

- Tips:
- Because two images are taken for each measurement, this mode has a long sampling period.
 - When measuring workpieces that move at a high speed, the NR image combination may not perform appropriately.

7.4.2 Image Brightness (Shutter Time and Gain)

Use shutter time and gain to adjust the camera screen brightness.
With "Auto adjust", the shutter speed will be adjusted to the optimum value.

Shutter

Set the camera shutter time. Set this value in steps of 5 μ s.
The longer the shutter time, the brighter the images that can be taken.
However, the images may be blurred for workpieces moving at high speeds.

Gain

Set the camera gain.
The larger the value, the higher the gain, which makes it possible to perform measurements even with small amounts of reflected light.
If you increase the gain too much, there will be lots of noise, which may lead to unstable measurements.

Auto adjust

Optimize capturing condition automatically that matches with currently set work piece.
Set the work piece to measure at the adequate position and execute "Auto adjust".
Don't move the work piece while "Auto adjust" is proceeded.
When external trigger is used, check the profile is captured as you expected for around 20 to 50 times, depends on the condition, to make sure.

- Tips:
- "Hi-res" and "NR-Mode", "Gain", "shutter time", "Threshold" and "Reject Level" will be adjusted automatically by pressing "Auto adjust" button.
 - When you do not use automatic adjustment, set the shutter speed and the gain, and then adjust these settings so that the appropriate received light waveform is generated. If the amount of light is insufficient (the center waveform) or is too large (the lower-right waveform), it will be difficult to perform accurate measurements. Adjust the shutter speed and the gain until the received light waveform becomes like the one shown below in the lower-left.

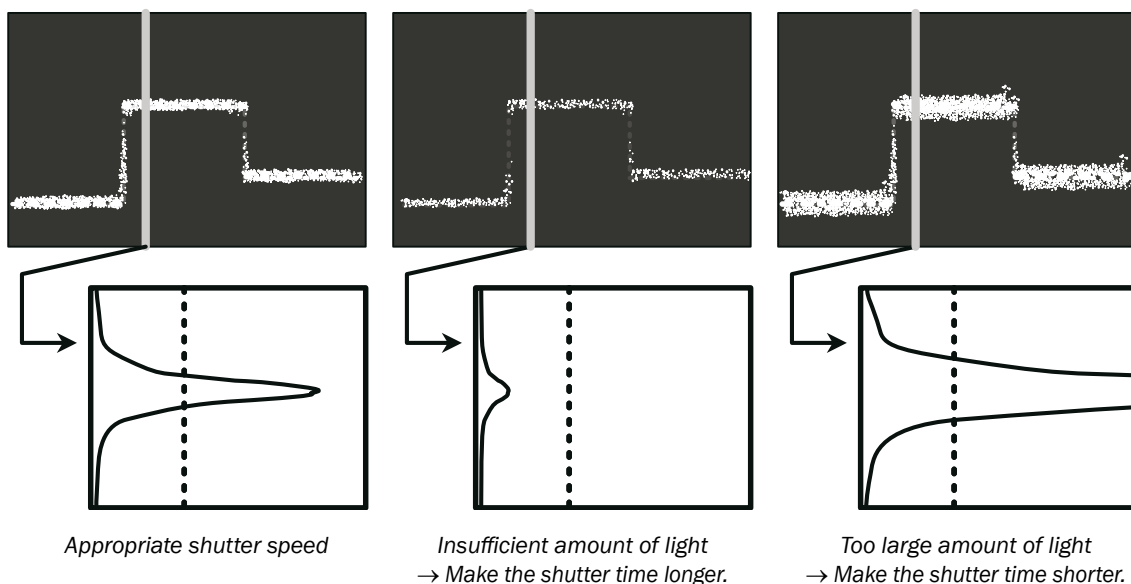

7.4.3 Camera Range

Set the camera Range.

The narrower you set the camera range, the shorter the imaging time and the sampling period become.

The default value is the entire camera range. (Sampling period: 5 ms)

Purpose of narrowing the camera range

Narrowing the camera range has advantages such as those shown below.

(a) Shortening of the measurement time

When you narrow the camera range, the sampling period will be shortened by a corresponding amount.

This makes it possible to perform measurements on production lines that move at faster speeds.

(b) Noise prevention

Depending on the workpiece profile and the environment, measurements may be unstable due to the presence of noise and diffuse-reflected light. Setting the camera area just to the measurement range can prevent the influence of these elements on the measured results.

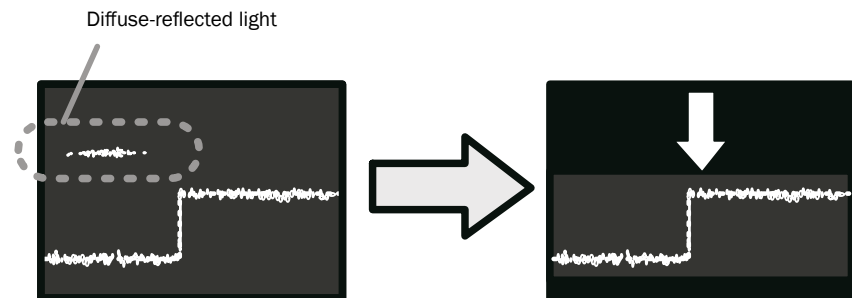

Figure: Example of noise prevention implemented by narrowing the camera area

7.4.4 Received Light Waveform and Measurements

The heights of all the parts where the laser strikes the target are measured from the waveform. The waveform is a vertical graph of the reflected light of the laser.

The following two settings are related to the recognition of the received light waveform. Normally you do not have to change these settings.

Threshold

If the amount of light of a part of the received light waveform is less than or equal to this setting value, that part of the waveform triggers alarm (no measured value).

The unit is the received light amount (in 256 levels).

If you specify a value that is too high, the number of areas where measurement is not possible will increase.

If you specify a value that is too low, noise components will also be measured, which may lead to unstable measurements.

[1] The peak of the received light waveform is greater than or equal to the light amount threshold.

[2] The peak of the received light waveform is less than the light amount threshold.

Light amount threshold

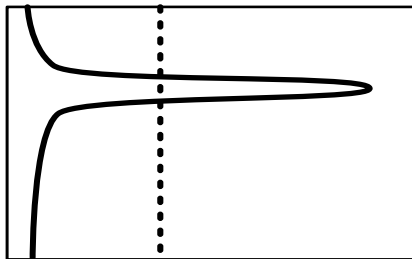

Measurement is possible.

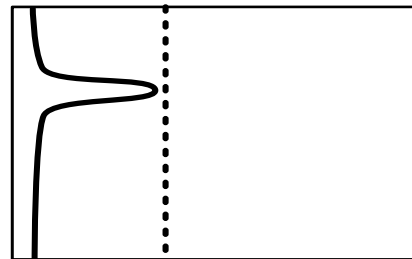

Alarm

Functions

Reject level

Sets the range to measure when measuring the peak position of the received light waveform.

Use the reject level to specify what the lower percentage of the received light waveform to ignore during calculations.

If you specify a value that is too high, the measured value may be unstable due to the surface status.

If you specify a value that is too low, diffuse-reflected light and noise will be measured, which may lead to unstable measured values.

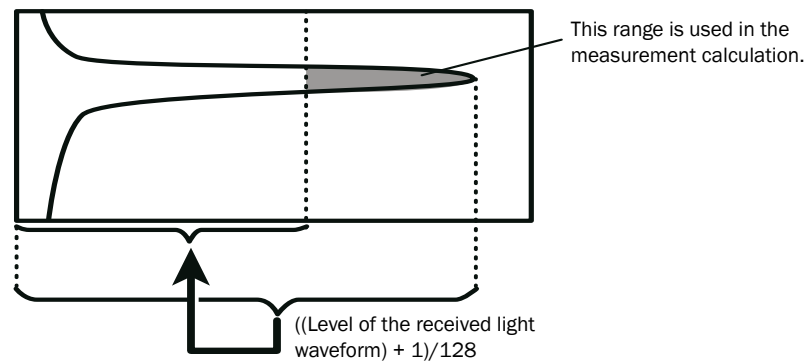

Figure: Determining the area to use in calculations

7.5 Profile Settings

7.5.1 Profile Extraction Settings

Reject level

Sets the range to measure when measuring the peak position of the received light waveform.

Use the reject level to specify what the lower percentage of the received light waveform to ignore during calculations.

If you specify a value that is too high, the measured value may be unstable due to the surface status.

If you specify a value that is too low, diffuse-reflected light and noise will be measured, which may lead to unstable measured values.

Target

Select the measurement target from “Normal,” “Gap,” and “Semi-trans.” “Normal” is standard.

Use this setting to specify what parts of the received light waveform to use as measurement data.

a) Normal

Reject level

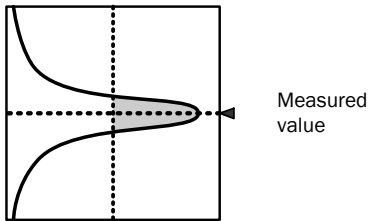

The peak position of the received light waveform will be measured. The center is measured, excluding the data from the point where the amount of light is largest to the reject level.

b) Gap

Reject level (difference)

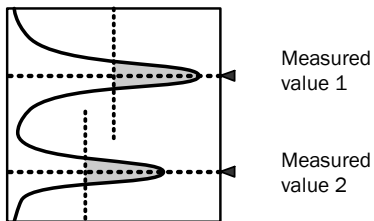

Level differences that have sudden height changes will be measured. The measurement method is the same as the "Normal" setting, but two measured values are output from one received light waveform.

Tips: The difference in measured results for level differences with the "Normal" and "Gap" settings is shown below. With the "Normal" setting, level difference cannot be measured accurately. This can be improved by using the "Gap" setting as shown in the picture below:

[Operation difference for a profile that has level differences]

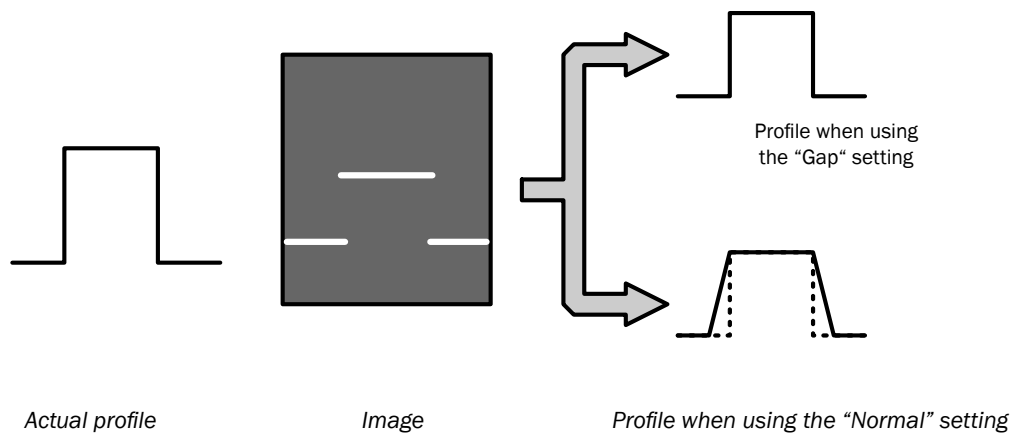

Functions

c) Semi-trans

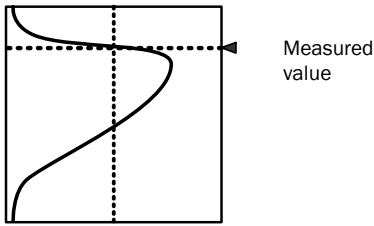

Use this setting when measuring semi-transparent objects such as resin or erasers where the light enters the workpiece and causes internal reflections.

With semi-transparent workpieces, the waveform profile is not stable, so the "Reject level" setting is ignored, and the center is calculated from the entire waveform.

Tips: • Compared to other modes, the measured result precision is low.

Alarm limit

Set the behavior in case of an alarm (part where there is no measurement data).

When you specify the alarm limit, the specified number of profile values to the right will be maintained.

If alarms occur repeatedly such that the specified number of values is exceeded, an alarm (value outside of measurement range) occurs.

If you set "Alarm limit" to "HOLD," alarm state is not entered.

In the following figures, alarms are indicated with an "X," and thick lines are used to indicate the parts in which the immediately preceding values are maintained.

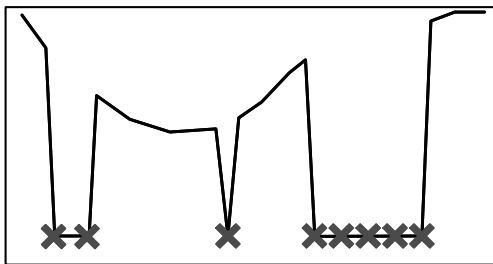

Alarm limit: 0

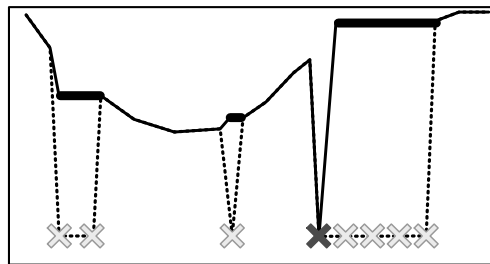

Alarm limit: 4

Figure: Profile change caused by the "Alarm limit" setting

Smoothing

Performs averaging within the profile. Specify a setting of “1” to disable averaging.
 When you specify a setting of “2” or higher, the measured values to the right – including the measured value at that position – will be averaged the number of times specified by the averaging count.
 If the target data causes an alarm, the corresponding value will not be included in the averaging.

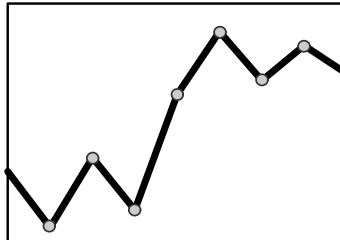

Smoothing: 1 time (no averaging)

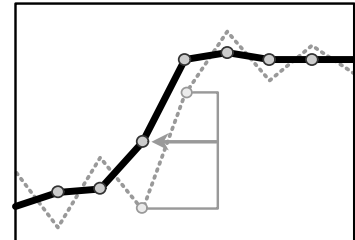

Smoothing: 2 times (solid line)

Figure: Profile difference caused by the “Smoothing” setting

7.5.2 Save Master

Register the acquired profile as the master image.
 The correction functions and comparisons with measured details are set with the registered master image as the reference.
 You can save one master image for each bank.

- Tips:*
- When you change the reference coordinates for the height, position, or tilt correction and when you change the correction procedure, you have to register the master image again. If you do not register the master image, the correction functions will not operate correctly.

7.5.3 Profile Correction

When the target's position is shifted during measurement, you can correct the position and height of the area.

With the Profiler 2, you can correct the height, position, and tilt.

Do not use the correction functions when absolute positions are necessary such as for web guide control.

Tips:

- If the correction causes a part of that area to exit the settable range, measurement will not be possible.

[Reference] Measurement and setting ranges

(): Measurable area (with the maximum camera area)

[]: Settable area

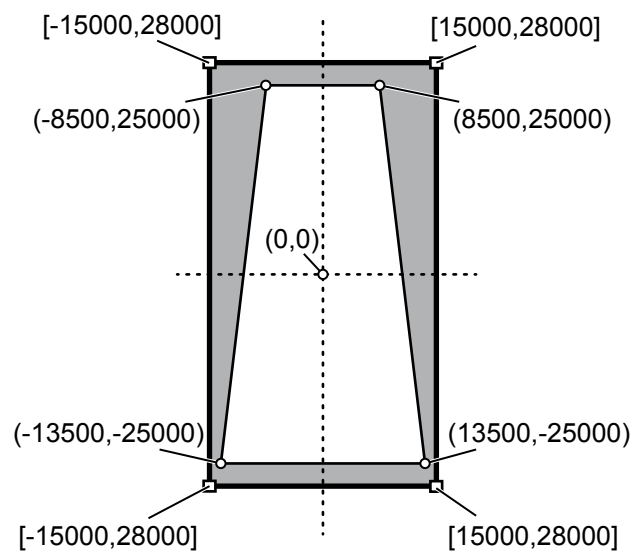

- You can set one height correction, position correction, and tilt correction for each bank.
- You can switch between using height correction and position correction for each area.
- When you are using tilt correction, you cannot set it to ON or OFF for each area.

H correct

Sets the threshold. If the profile exceeds the threshold, the waveform will be moved horizontally to the reference position.

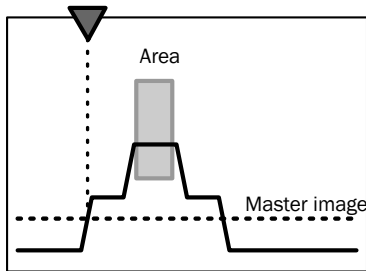

1. Set the reference height.

Set the reference height, corresponding to the master image, where correction will be performed.

The position farthest to the right or left that crosses this height will be the correction reference position. (In the figure to the right, the reference is the left position.)

Set the reference to a height that will definitely be crossed by the master image and by the profile during measurement.

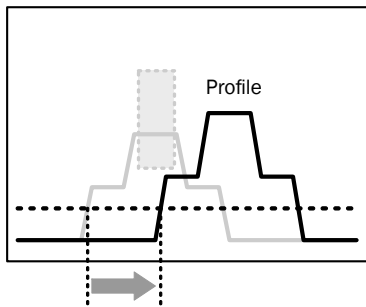

2. Perform measurements.

Measure the points on the measured profile that have exceeded the threshold.

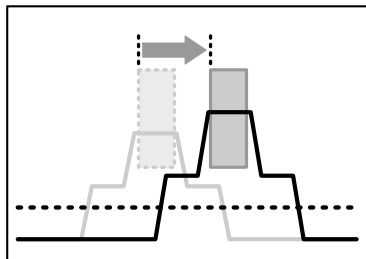

3. Perform corrections.

The area will be moved by just the amount that the measured waveform and master image positions are shifted.

- Tips:*
- If you specify a height for which there is no measured data in the master image, the position correction is not performed.
 - If there is no measured data at the specified height during measurement, measurement is performed without correction.
 - Perform position correction for convex profiles like those described above. Position correction may not operate correctly for concave surfaces.
 - For level differences, whether the correction will be performed appropriately varies depending on the correction direction.

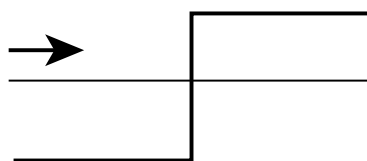

○: The correction can be performed appropriately.

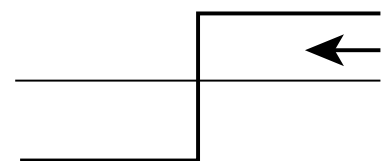

×: The correction may not be performed appropriately.

Functions

V correct

Sets the reference position. The height is adjusted so that it is equal to the height of this position.

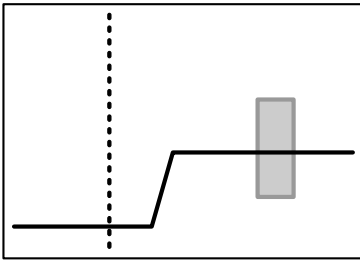

1. Set the reference position.

Set the reference position, corresponding to the master image, at which correction will be performed. The height will be corrected so that it becomes the same as that of the measured value at this position.

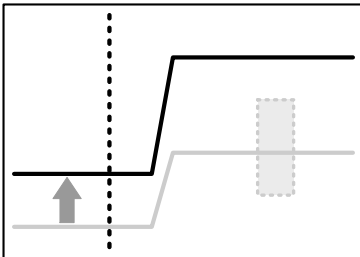

2. Perform measurements.

Measure the height at the reference position on the measured profile.

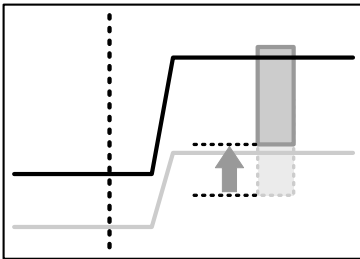

3. Perform corrections.

The area will be corrected by the amount of the height difference between the master image and the measured profile.

- Tips:
- If you specify a position at which an alarm occurs on the master profile, the height correction is not performed.
 - If an alarm occurs at the specified position during measurement, measurement is performed without correction.

Correct method

Sets whether to use position and height corrections and the order to use these corrections in.

- -: Correction will not be performed.
- →: Position correction (left side) will be performed.
- ←: Position correction (right side) will be performed.
- ↑→: Height correction will be performed, and then position correction (left side) will be performed.
- ↑←: Height correction will be performed, and then position correction (right side) will be performed.
- ↑: Height correction will be performed.

The actual correction operation behaves as shown below.
The "↑→" correction operation is explained here.

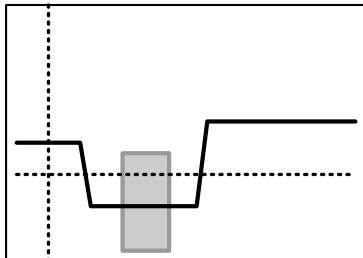

1. Set the reference position and height.

Set the reference position and height, corresponding to the master image, at which correction will be performed.

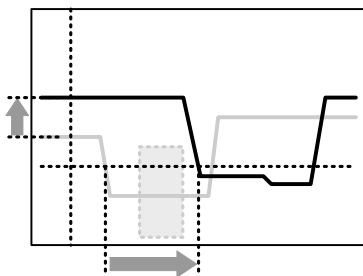

2. Perform measurements, and then detect the height and position correction amounts.

Detect the height and position correction amounts from the master image and the measured profile.

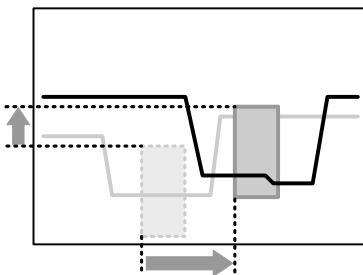

3. Correct and measure the area.

Move the area according to the correction, and then measure the area.

Functions

Tilt method

Corrects the installation tilt and the tilt of the measurement target object. The profile tilt will be corrected so that the height correction reference position and the tilt correction reference position become level with each other. If an alarm occurs in either of the reference positions, the tilt correction will not be performed. In master image registration, the profile after tilt correction is performed is registered. In tilt correction, the shape of the profile is corrected. The area position is not corrected.

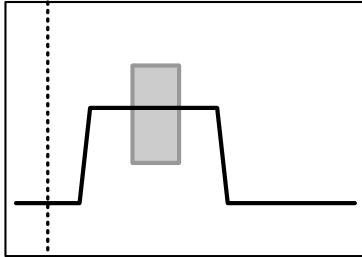

1. Set the height correction reference position.

This reference position is also used in tilt correction. (The dotted line is the height correction reference position.)

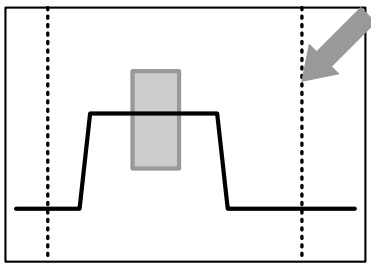

2. Set the tilt correction reference position.

Set the reference position to the same height as the height correction reference position. (The dotted line indicated by the arrow is the tilt correction reference position.)

Before Correction

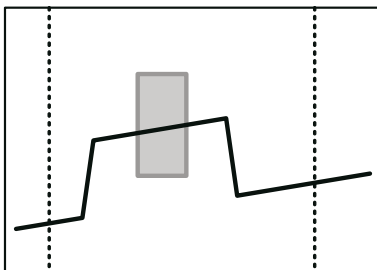

3. The correction is performed so that the two reference position heights become the same.

The tilt correction is performed so that the two reference position heights become the same.

After Correction

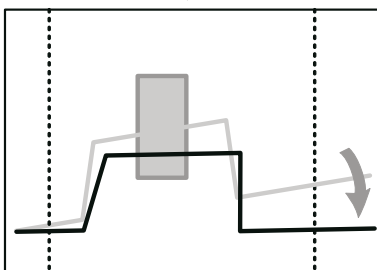

7.6 Area Settings

The Profiler 2 sets “areas” within the measurement range, and then performs measurements on these areas. You can specify up to four areas.

7.6.1 Measurement Areas

Sets the positions and sizes of the areas within the camera area. Areas are rectangles. You can also specify areas so that they overlap.

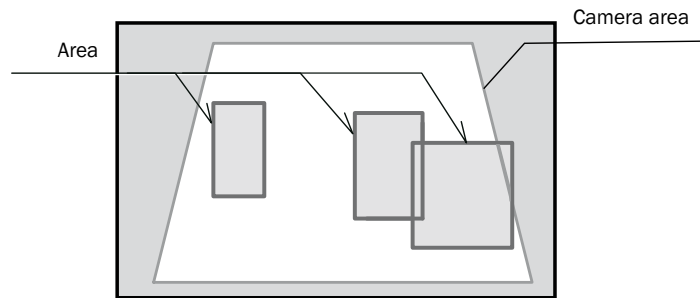

Figure: Example of area settings

If the profile does not pass through the area, the measured result will become "----- (measurement not possible)". Set the area so that measurement is possible.

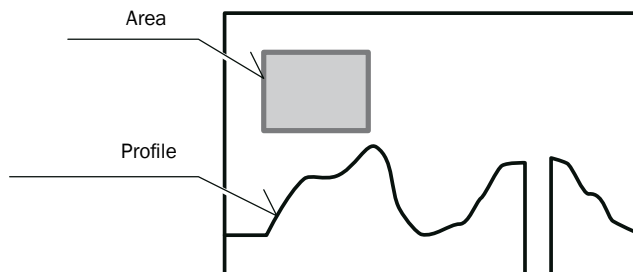
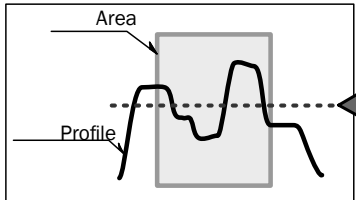

Figure: Profile and area that result in measurement not being possible

7.6.2 Measurement functions

Specifies the measurement functions for the areas.
You must configure different settings depending on the measurement function.



Average

The average of the measured values within the area are output.

- Tips:*
- Parts where an alarm occurs will not be used in the calculation of the average value.
 - For locations where the measured value is larger or smaller than the area, the measured values will not be used in the calculation of the average value.

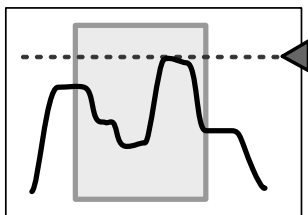

P height

The largest measured value within the area is output.

- Tips:*
- Parts where an alarm occurs will be ignored.
 - Within the range of the area, if there are measured values that are larger than the area, the peak height value will be the upper limit of the area.
 - The peak is determined by comparing the sizes of the measured values, so when "Axis dir" is set to "Far+," the peak will be in relation to the lower part of the screen.

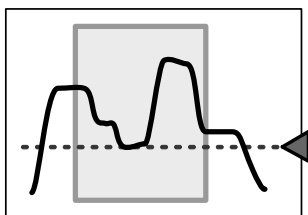

B height

The smallest measured value within the area is output.

- Tips:*
- Parts where an alarm occurs will be ignored.
 - Within the range of the area, if there are measured values that are smaller than the area, the bottom height value will be the lower limit of the area.
 - The bottom is determined by comparing the sizes of the measured values, so when "Axis dir" is set to "Far+," the bottom will be in relation to the upper part of the screen.

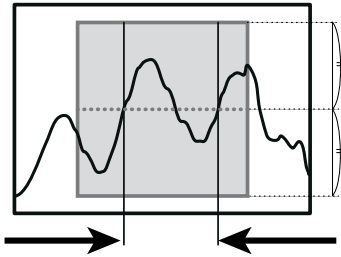

Width

The largest distance from the rightmost point to the leftmost point that cross the center of the area's height is output.
Use this function when you want to find the widths of protrusions and gaps.

Tips:

- The points that are detected by the width function are the positions that are detected by "Edge pos."

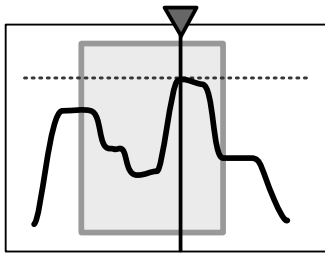

P pos

The position of the highest measured value within the area is output.

Tips:

- If there is an alarm within the area, the measured result will indicate that measurement is not possible.
- Within the range of the area, if there are measured values that are larger than the area, the measured result will indicate that measurement is not possible.
- If there are multiple positions that are all the maximum value, the leftmost position will be output.
- The peak is determined by comparing the sizes of the measured values, so when "Axis dir" is set to "Far+," the peak will be in relation to the lower part of the screen.

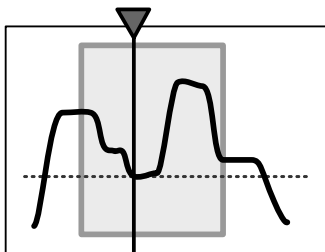

B pos

The position of the smallest measured value within the area is output.

Tips:

- If there is an alarm within the area, the measured result will indicate that measurement is not possible.
- Within the range of the area, if there are measured values that are smaller than the area, the measured result will indicate that measurement is not possible.
- If there are multiple positions that are all the minimum value, the leftmost position will be output.
- The bottom is determined by comparing the sizes of the measured values, so when "Axis dir" is set to "Far+," the bottom will be in relation to the upper part of the screen.

Functions

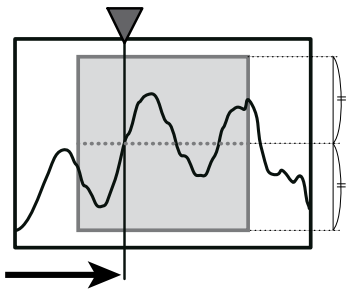

Edge pos

The rightmost point or the leftmost point that crosses the center of the area's height is output.

- Detection direction

Specify the direction from which to detect edges.

The figure to the right shows the detection result when detection from the left is specified.

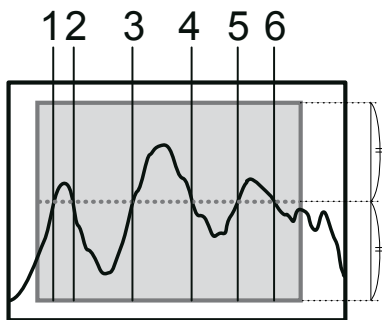

EdgeCount

The number of times that the profile crosses the center of the area's height will be counted.

Tilt

A straight line approximating the profile within the area is determined, and then the tilt of this straight line is measured.

The unit of the output value is degrees ($^{\circ}$).

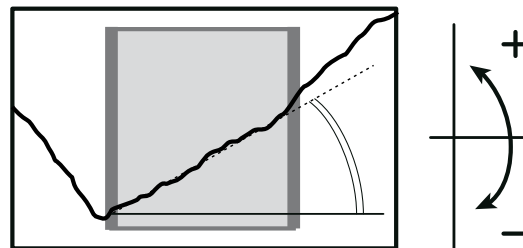

- Tips:**
- If there is data for which measurement is not possible within the area, the measured result will indicate that measurement is not possible.
 - In order to perform the tilt measurement, the profile must cross the left and right sides of the area (the thick-bordered frame). If the profile does not cross both sides, the measured result will indicate that measurement is not possible.
 - To measure the angle, you have to use the "Calc" function. ([7.7 Calculation Settings])

Size

The mathematical area of the section bounded by the profile and the specified height within the area is determined.

The unit of the output value is mathematical area (mm^2).

- **Direction**
Select the direction in which to perform the mathematical area measurement from “↑” (from the lower side of the area up) and “↓” (from the upper side of the area down) in relation to the specified height. The measurement areas for each of these settings are shown below. (The arrows indicate the set mathematical area directions and the shaded-in parts indicate the measurement areas.)

Tips: • Mathematical area measurement results have up to three decimal places. The fourth decimal place is zero (0).

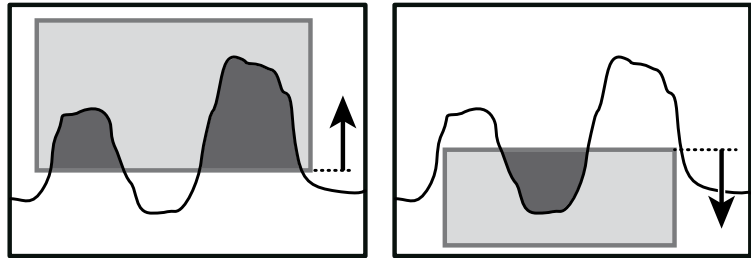

Length

The line length of the profile within the area is determined. The unit of the output value is length (mm).

Tips: • Because the line length is the same for the same profile, this function can be used to perform profile judgment.

Diameter

An approximate circle is determined from the measured values within the area, and then the diameter of this circle is output. The unit of the output value is length (mm).

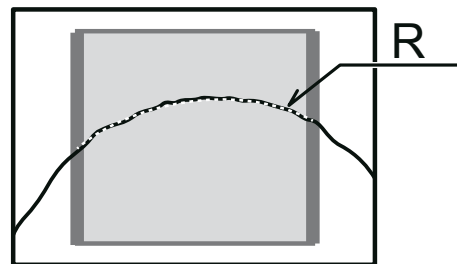

- **Direction**
Select the direction in which to perform the measurement from “↑” (from the lower side of the area up) and “↓” (from the upper side of the area down). Indicate the convex direction of the arc to measure.

- Tips:*
- In order to perform the diameter measurement, the profile must cross the left and right sides of the area (the thick-bordered frame). If the profile does not cross both sides, the measured result will indicate that measurement is not possible.
 - You can perform a more precise measurement by ensuring that the top of the arc is positioned in the center of the area and by measuring over a wide range.

Inflect

When the curvature of the point of the profile meets or exceeds the level set, output its position. When it can't detect the point meets the level, output result shows "—".

- Tips:*
- Inflection graph is not available.

7.7 Calculation Settings

Sets the processing to perform in relation to the measured values of each area.

7.7.1 Average

Averaging is performed the number of times specified over the measured results of the areas.

The more times specified for processing, the more stable the result, but the response speed is slower.

[Setting target:] Areas 1 to 4

- Tips:*
- If you have used "Smoothing" as described in "7.5.1 Profile Extraction Settings," the response speed will not be changed.

7.7.2 Hold

You can use hold mode to acquire the maximum or minimum value in the specified length of time.

By detecting the maximum or minimum value while the workpiece passes by, you can easily check for problems such as the occurrence of abnormal values.

[Setting target:] Areas 1 to 4 and calculations 1 and 2

None

The hold operation is not performed. (Hold input will be ignored.)

Sample

The measured values during the hold input period are maintained.

Peak

The maximum value during the hold input period is output.

Bottom

The minimum value during the hold input period is output.

Reference: For details on the operation, see "9.4 Timing Charts."

7.7.3 Span

Multiply the measured values of the area by the specified value.
Use this function to correct the installation tilt and in similar situations.
[Setting target:] Areas 1 to 4 and calculations 1 and 2

7.7.4 Calculation Formulas

You can perform calculations with the measured results of multiple areas.
Set up to two calculation formulas. The calculation formulas are defined as shown below. Select from the following values for the calculation targets and for the operator.

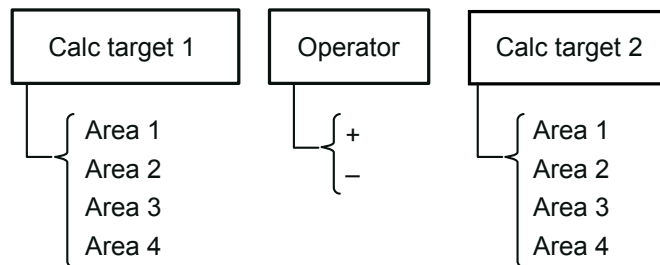

[Setting target:] Calculations 1 and 2

Calc target1 and Calc target2

Select the targets to use in the calculation. Select from areas 1 to 4.

Operator

Select the operator to place between the areas.

Actual calculation example

To perform measurements such as level difference measurements and angle measurements, use the calculation settings.

To perform a level difference measurement, measure the heights of the upper and lower surfaces of the level difference, and then subtract one height from the other.

■ Area settings

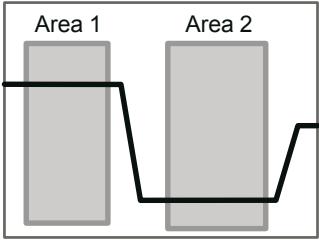

■ Calculation formula



(Average height) (Average height)

To perform an angle measurement, measure the angles of the two components that make up the angle that you want to measure, and then subtract one angle from the other. When a measurement is performed with the following formula, the outer angle of the gap or protrusion is output. To output the inner angle, set "180" for the offset value.

7.8 Output Settings

7.8.1 Out target

Select the output target area.
[Setting target:] Outputs 1 to 3 and analog output
Select the target from the following parameters.

- Area1
 - Area2
 - Area3
 - Area4
 - Calc1
 - Calc2
- } The measured result of the area is set as the output target.
- } The calculation result is set as the output target.

The illustrations shown in the explanations are when "Out polar" is set to "N.O." and "On Timing" is set to "Out range".

7.8.2 Thresholds and Output

[Setting target:] Outputs 1 to 3

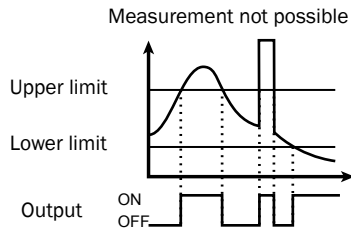

Upper limit/Lower limit

Set the upper and lower limits (thresholds) that will be used to perform output judgments.

Output turns on when one of the following conditions is met.

- (When “Out polar” is “N.O.”)
- The value exceeds the upper limit.
- The value falls below the lower limit.
- Measurement is not possible.

Tips:

- *Thresholds are judged based on the offset value. For example, output will turn on as shown below when the offset value is 100 mm and the upper limit is 10 mm. Offset value (100 mm) + Upper limit (10 mm) = 110 mm (Refer to the figure to the right. Changing the offset value will shift the upper and lower limit accordingly.)*

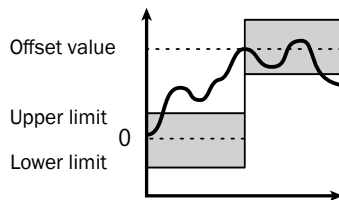

Out polar

- **N.O.:** Output turns on when a measurement result is outside the range defined by the threshold upper limit and lower limit, or when measurement is not possible.
- **N.C.:** Output turns on when the measurement result is within the range defined by the threshold upper limit and lower limit.

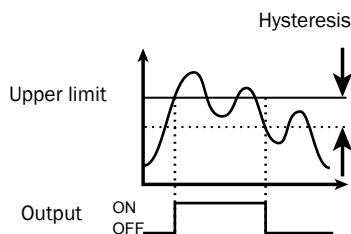

Hysteresis

Set the amount that the value can fall below (or exceed) the threshold before output is turned off.

This is useful in preventing chattering, the repeated turning on and off of the output when the value is in the vicinity of the threshold.

Tips:

- *The threshold judgment operation is performed in accordance with the “Out polar” and “On Timing” settings as shown in the table below.*

Out polar	N.O.		N.C.	
	Out range	In range	Out range	In range
Trigger input standby *1	O	O	C	C
Within threshold range	O	C	C	O
Outside threshold range	C	O	O	C
Measurement not possible *2	C	O	O	C
(Disconnected)	O	O	O	O

*1 *Trigger input standby:* From startup, reset process, or bank switching until initial trigger input

*2 *Measurement not possible:* When measurement results for the target area are “-----”. (Area inappropriate for profile.)

Functions

*C: Closed state

*O: Open state

7.8.3 Out action

Set the output operation.
[Setting target:] Outputs 1 to 3

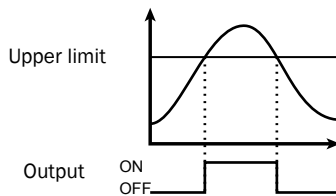

Normal

The output turns on when the measured value is outside of the threshold range.

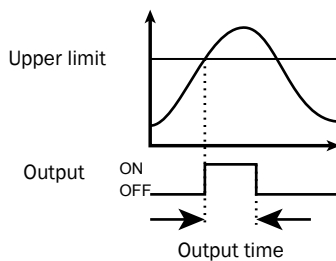

1shot

The output turns on for the specified output time when the measured value is outside the threshold range.

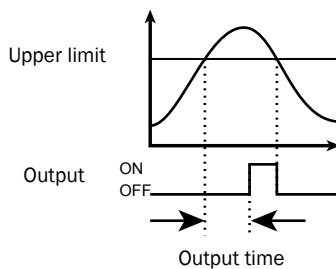

OnDelay

The output turns on after the specified output time elapses when the measured value is outside the threshold range.

Ready

Output turns on when the trigger input can be received.

Tips:

- With the "Ready" setting, the output does not indicate the measured value.

Strobe

Each time that the measured value is updated, the output turns on just for the output time.

If the output time is longer than the sampling period, the output turns off after the output time elapses and turns on when the next update occurs.

Tips:

- With the "Strobe" setting, the output does not indicate the measured value.

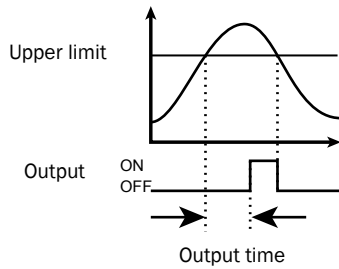

1shot2

The output turns on only for the specified output time when the measured value is outside the threshold range. Since output is performed only when the measured value is outside the threshold range, output does not turn on when there are continuous out of range values.

Output time

When using the “1shot,” “OnDelay,” or “Strobe” setting, specify the output time.

7.8.4 Offset/Offset Value

When offset input is received, values are added to or subtracted from the current display value so that it becomes the value set with “Offset value.” The offset value can be set for each output.

When the offset operation is executed, values are added to or subtracted from the measured value of (1) the area that the output is referencing or (2) a calculation. (The parts indicated with dotted lines in the following figure.)

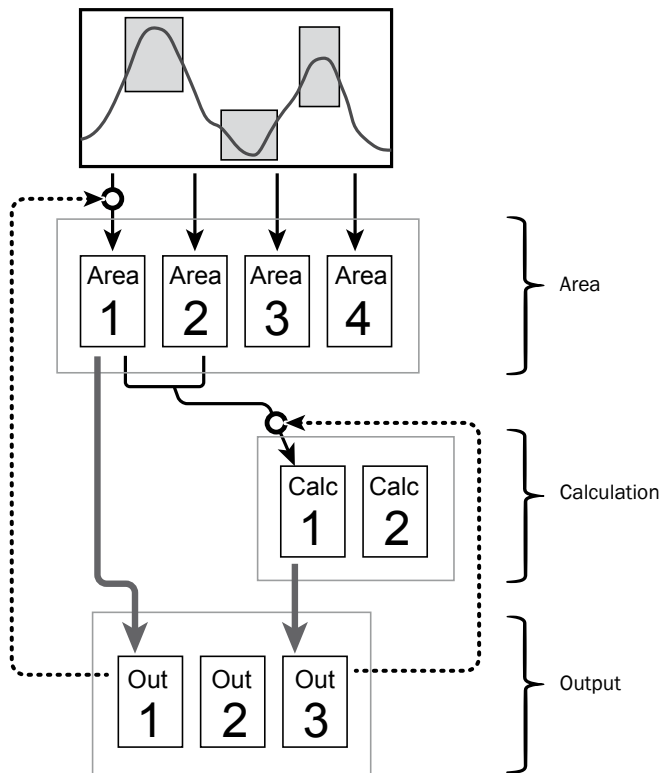

[Setting target:] Outputs 1 to 3

Functions

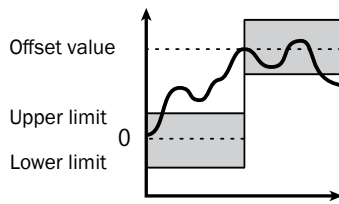

- Tips:
- “Offset” and “Offset value” operate on areas and calculations. Therefore, the values of any other calculations or outputs that are referencing the area or calculation in question will also be changed. In the above figure, if the offset operation is executed on output 1 (the dotted line on the left side of the figure), the values of calculation 1 and output 3 – which are referencing area 1 – will also be changed.
 - Thresholds are judged based on the offset value. For example, output will turn on as shown below when the offset value is 100 mm and the upper limit is 10 mm. $\text{Offset value (100 mm) + Upper limit (10 mm) = 110 mm}$ (Refer to the figure to the right. Changing the offset value will shift the upper and lower limit accordingly.)

7.8.5 Analog Output Range

Sets the output range of the analog current output.
To set this range, set arbitrary upper and lower limits on the output.
The default output range is shown in the following figure.
The analog output resolution of the Profiler 2 is approximately 0.4 μA .

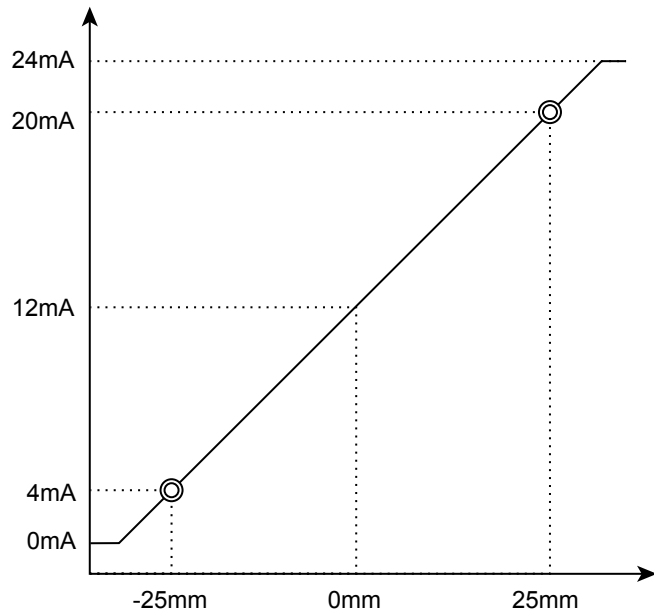

Figure: Analog output operation

[Setting target:] Analog output

- Tips:
- Set the "20mA" and "4mA" input values so that they meet the following conditions. If the following conditions are not met, analog output will not be performed correctly.
 - The "20mA" input value must be greater than the "4mA" input value.
 - The difference between the "20mA" and "4mA" input values must be 1.000 or more.

7.9 Common Settings

7.9.1 Banks

The Profiler 2 stores measurement conditions in “banks.” You can switch between banks according to the details to measure. You can use the sensor or communication to switch between banks.

Bank switch

- In/Para
- You can use the sensor screen and input terminals to switch between banks.
- Comm
- You can use communication to switch between banks. If you use PRO2-Navigator to switch between banks, this setting will automatically be switched to “Comm.”

Switching between banks when “Bank switch” is set to “In/Para”

When “Bank switch” is set to “In/Para,” set the input terminals as shown in the following table in order to switch between banks.

You can use the “Bank” setting of the sensor to switch between banks when there are terminals that are not assigned to bank 1, 2, or 3.

Bank input 1	Bank input 2	Bank input 3	Bank
OFF	OFF	OFF	1
ON	OFF	OFF	2
OFF	ON	OFF	3
ON	ON	OFF	4
OFF	OFF	ON	5
ON	OFF	ON	6
OFF	ON	ON	7
ON	ON	ON	8

7.9.2 Baud rate

Set the communication speed.

The Profiler 2 communication speed can only be changed from the sensor.

Reference: For details on the communication speed setting, see “8.1 Communication Specifications.”

7.9.3 Axis dir

Set the direction in which to increase and decrease the height direction measured value.

Select "Near+" (the measured value will increase toward the side near to the sensor head) or "Far+" (the measured value will increase toward the side far from the sensor head). In both situations, the origin is the center of the measurement range (at 100 mm).

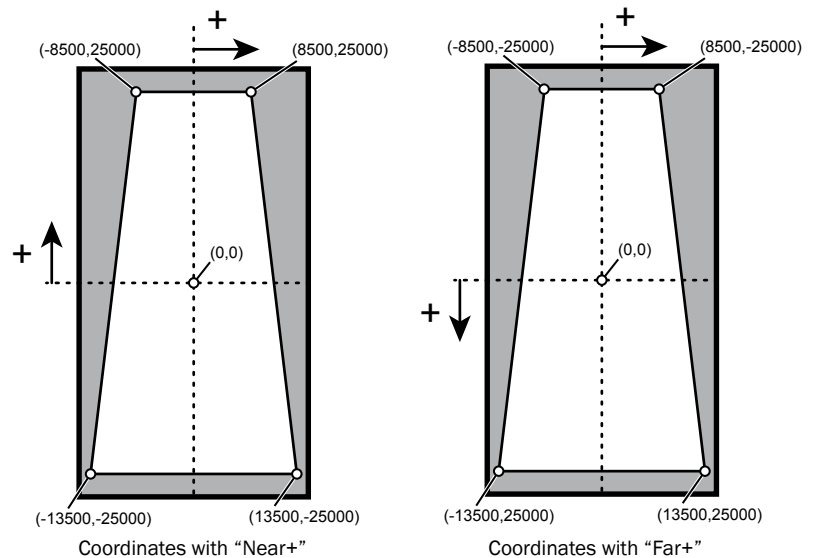

Figure: Axis direction and coordinates

Tips:

- In the horizontal direction, the measured value always increases to the right. This cannot be changed with the above setting.

7.9.4 On Timing

Specify the judgment output operation.

- Out range: Output turns on when the measurement result is outside the range specified by the threshold.
- In range: Output turns on when the measurement result is within the range specified by the threshold.

7.9.5 Lang/言語

Change the display language. This setting has no effect on operations. You can set the display language separately for the sensor and for PRO2-Navigator.

Functions

7.9.6 Screen Saver

Specify the operation after 30 seconds without any access to console buttons.

- Dark: The back light will get dark without any access to console buttons.
- LCD OFF: The back light will be completely OFF without any access to the console buttons. While LCD back light is OFF, The Profiler 2 response speed of communication will be faster.

Tips: • "LCD OFF" is recommended while "PRO2-Navigator" is used or heavy communication is needed through RS-485 I/F.

7.9.7 Brightness

Adjust the brightness of the Profiler 2 display.
The larger the number, the brighter the screen will be displayed.

7.9.8 Initialize

Return the settings to their factory defaults.
You can select "All" or "Bank" for the range of settings that will be initialized.

7.9.9 Version

Display the version of the sensor.

8 Serial Communication

8.1 Communication Specifications

8.1.1 Communication Specifications

Communication method	EIA RS-485 (half duplex)
Transmission code	Binary
Data length	8 bits
Stop length	1 bit
Parity check	None
Baud rate	9600, 19.2 k, 38.4 k, 57.6 k, 115 k, 230 k, 460 k, 921 k, 2.0 M, 4.0 M (bps)
Header	STX
Data delimiter	ETX

Use a dedicated communication cable to perform communication.

8.1.2 Timing Chart During Communication

During communication, the timing chart is shown below.

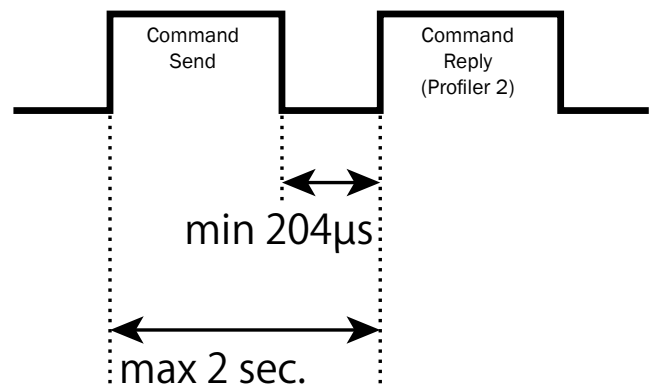

- Collision detection is not performed (P to P connections only).
- The baud rate can only be changed by operating the sensor. It cannot be changed by way of communication commands or PRO2-Navigator.
- A time-out will occur if the send time of the command exceeds 2 seconds.
- Response time to the command varies depends on the baud rate.

Baud rate	9600bps	19200bps	38400bps ~
Response time	1.8ms (fixed)	1ms (fixed)	204µs ~

Serial Communication

8.1.3 Command Format

All sent and received commands are communicated in the following format.

Label	STX	Data length	Command	Data part	ETX	Checksum
Number of bytes	1	1	2	0 to 510	1	1

	Number of bytes	Data	Details
STX	1	STX (02h)	—
Data length	1		The length of the data is written in units of words. (1 word = 2 bytes)
Command	2		Communication command
Data part	0 to 510		
ETX	1	ETX (03h)	—
Checksum	1		The value resulting from the XOR calculation of the values from STX to ETX (excluding STX and ETX)

Tips:

- One response is always returned for each command. If communication is performed correctly, the same command as that which was sent will be returned. If an error occurs during communication, the error code will be returned.

Command	02	00	20	1b	03	?
Description	STX	Length	Command		ETX	Sum

1.

The XOR calculation is performed on the value of each byte excluding STX and ETX.

```

00: 00000000
20: 10000000
1b: 00011011
-----
10011011 → 0x3b

```

* XOR calculation: Each binary digit is compared. If the number of 1s is odd, the result is 1. If the number of 1s is even, the result is 0.

Tips:

- You can even use Calculator in the Windows® Accessories folder to perform this calculation.
- By changing Calculator to “Programmer” (“Scientific” in Windows® XP or Vista) mode, you can perform calculations in hexadecimal and switch between hexadecimal and binary notations. You can also perform “XOR” calculations.

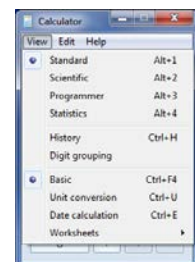

8.2 How to Acquire Measured Values

This section explains how to use communication to acquire measured values.

8.2.1 Commands for Acquiring Measured Values

Function	Set or acquire	Send or reply	Length	Command (hex)	Data string	Parameter									
Acquire measured results	Acquire	Send	1	a017	000a	a: Output									
		Reply	2		bbbbbbbb	<table border="1"> <thead> <tr> <th>a</th> <th>Setting value</th> <th>a</th> <th>Setting value</th> </tr> </thead> <tbody> <tr> <td>0</td> <td>OUT1</td> <td>2</td> <td>OUT3</td> </tr> <tr> <td>1</td> <td>OUT2</td> <td>3</td> <td>OUTA</td> </tr> </tbody> </table> bbbbbbbb: Measured result	a	Setting value	a	Setting value	0	OUT1	2	OUT3	1
a	Setting value	a	Setting value												
0	OUT1	2	OUT3												
1	OUT2	3	OUTA												
Acquire the output status	Acquire	Send	0	a010	–	a: Output status (ouput with bits)									
		Reply	1		000a	b0: OUT1, b1: OUT2, b2: OUT3									

Tips:[OUT] data add [AVERAGE] [HOLD] [SPAN] process from [AREA] data.

8.2.2 Communication Command Examples

Acquisition command

- When acquiring the measured value of OUT1

Sent command

Command	02	01	a0	17	00	00	03	B6
Description	STX	Length	Command		Output		ETX	Sum

Received command

Command	02	02	a0	17	00	00	5a	62	03	8D
Description	STX	Length	Command		Measured value				ETX	Sum

You can see that the measured value of OUT1 is 0x5a62 = 23138 (µm).

8.3 How to Acquire Profiles

This section explains how to use communication to acquire profile data.

8.3.1 Commands for Acquiring Profile Data

Use these commands to acquire profile data.

Function	Set or acquire	Send or reply	Length	Command (hex)	Data string	Parameter
Acquire the address	Acquire	Send	0	400B	-	aaaaaaa: Address
		Reply	2		aaaaaaa	
Acquire the profile	Acquire	Send	3	0002	aaaaaaaabbcd	aaaaaaa: Address bb: Length of the read data (in units of words) c: Data size d: Increase amount 11: Fixed value cccc...: Data
		Reply	3 to FF		aaaaaaaacccc...	

8.3.2 How to Acquire Profile Data

Follow the procedure below to acquire profile data.

Acquiring the profile address

Profile data is saved in internal memory, so, to acquire the data, you first have to acquire the address at which the data is saved.

Send (address acquisition command)

02	00	40	0B	03	4B
STX	Length	Acquisition command		ETX	Sum

Reply

02	02	40	0B	03	06	20	00	03	6C
STX	Length	Acquisition command	Reply data				ETX	Sum	

The profile data is stored at address 03062000.

Acquiring the profile size

The profile size varies depending on the settings. Therefore, use the following command to acquire the profile size. Enter the acquired address in the "Address" part of the command. All other parts are fixed values.

Send

02	03	00	02	03	06	20	00	01	11	03	34
STX	Length	Acquisition command		Address				rLen	(Fixed value)	ETX	Sum

Reply

02	03	00	02	03	06	20	00	68	00	10	0E	03	4C
STX	Length	Acquisition command		Address				Size		Time information		ETX	Sum

The value obtained here is 0x6800. Dividing this value by 32 gives 832, which is the number of profiles.

For time information, a value is input that represents a count in 0.1 ms units the time from power on and startup.

Reading profiles

After you acquire the address and size of the profile, read the profile values. The maximum data that can be read with a single command is 126 (0x7E), so use multiple commands to read the profile.

Also, the reading of the address starts after the 4 bytes of the profile header are added.

Since the data size of each profile coordinate is 2 words (4 bytes), the read data size is "2".

Send

02	03	00	02	03	06	20	04	7E	21	03	7F
STX	Length	Acquisition command		Address				rLen	Thinning	ETX	Sum

* The value "03062000 + 4" is assigned to the address.

Reply

02	FF	00	02	03	06	20	04	CC	F9	10	35	CD	1D	03	02	
STX	Length	Acquisition command		Address				X0	Y0	X1	Y1	...	ETX	Sum					

Serial Communication

Each X and Y coordinate is a signed 16-bit value. Also, the value "0x7FFF" indicates that measurement is not possible.

After you acquire 126 data points worth of data, specify the address 252 words (126 data points x 2 words) worth of data after the current address, and then use the same procedure to acquire the next data. Repeat this operation until you have acquired all the data.

To draw the profile, plot the acquired X and Y coordinates in order.

Tips:

- A thinning value is specified to speed up data communication by thinning the profile data points.
For example, the commands shown below would perform thinning of at each data point (which would reduce the data points acquired by half).

Send

02	03	00	02	03	06	20	04	7E	22	03	7C
STX	Length	Acquisition command	Address				rLen	Thinning	ETX	Sum	

* The value "03062000 + 4" is assigned to the address.

Reply

02	FF	00	02	03	06	20	04	CC	F9	10	35	CD	F2	03	04
STX	Length	Acquisition command	Address				X0	Y0	X1	Y2	...	ETX	Sum					

- In this case, acquired coordinates are: 0, 2, 4, 6, etc.
A thinning value up to 2F (1/15 thinning) can be input.

8.4 Storage Data Acquisition Method

This section explains how to acquire data stored using the storage function.

8.4.1 Commands for Acquiring Storage Data

Use these commands to acquire storage data.

Function	Set or acquire	Send or reply	Length	Command (hex)	Data string	Parameter
Acquire the address	Acquire	Send	0	C00D	—	aaaaaaa: Measured value address
		Reply	4		aaaaaaaabbbbbbb	bbbbbbb: Profile address
Acquire number of data item	Acquire	Send	0	C010	—	aaaa: Number of data items
		Reply	1		aaaa	

Function	Set or acquire	Send or reply	Length	Command (hex)	Data string	Parameter
Acquire storage data	Acquire	Send	3	0002	aaaaaaaaabb11	aaaaaaaa: Address bb: Length of the read data (in units of words) 11: Fixed value cccc...: Data
		Reply	3 to FF		aaaaaaaaacccc.....	

8.4.2 How to Acquire Storage Data

Follow the procedure below to acquire storage data.

Acquiring the storage address

Storage data is saved in internal memory, so, to acquire the data, you first have to acquire the address at which the data is saved.

Send (address acquisition command)

02	00	C0	0D	03	CD
STX	Length	Acquisition command		ETX	Sum

Reply

02	04	C0	0D	00	90	00	00	01	00	00	00	03	C1
STX	Length	Acquisition command		Measured value address				Profile address				ETX	Sum

The measured value is stored at address 00900000, while the profile is stored at address 01000000.

Acquiring number of storage data item

Use this command to check the number of stored data items.

Send

02	00	C0	10	03	D0
STX	Length	Acquisition command		ETX	Sum

Reply

02	01	C0	10	03	E8	03	38
STX	Length	Acquisition command		Number of data items		ETX	Sum

0x03E8 (hexadecimal) = 1000 (decimal), so it indicates that there are 1000 storage items of measured values and profiles (cumulative).

Acquiring measured value storage data

The measured value storage results are aligned starting from the address that was acquired previously. (32 bytes per data item)

253 words (506 bytes) of data can be acquired at one time, so data acquisition needs to be divided between multiple executions when the number of measured value storages is 16 or greater.

Send

02	03	00	02	00	09	00	00	FD	11	03	CC
STX	Length	Acquisition command	Address					rLen	(Fixed value)	ETX	Sum

Reply

02	FF	00	02	03	06	20	04	CC	F9	10	35	CD	1D	03	06
STX	Length	Acquisition command	Number of data items				Area 1 measured value					ETX	Sum					

A breakdown of the acquired measured value data (32 bytes) is shown below.

- Data string: aaaabbbbccccddddeeeeffffgggggggg
- aaaa: Area 1 measured value
- bbbb: Area 2 measured value
- cccc: Area 3 measured value
- dddd: Area 4 measured value
- eeee: Calculation 1 measured value
- ffff: Calculation 2 measured value
- gggggggg: (not disclosed)

- Tips:*
- Data needs to be rearranged as shown below when reading each measured value.
 - Example: 4-byte measured value (A1)(A2)(A3)(A4)
This measured value needs to be rearranged to (A3)(A4)(A1)(A2) for reading.
 - Example: When the data EB F4 FF FF is in Area 1
Measured value becomes 0x FFFEBF4 = -5.305 (mm).
 - If measurement is not possible or if there is no measured value, the measured value becomes 7FFFFFFF.

Acquiring profile storage data

- The storage data format is the same as the general profile (see [8.3 How to Acquire Profiles" on page 114]).
- The next profile address from a single profile is the address that is a fixed value 0x800 (2048) away.
- This acquisition operation is repeated for profile storage acquisition.

8.5 Setting Acquisition and Change Commands

This section explains the communication commands related to various settings.

8.5.1 Communication Command Examples

Setting acquisition command

- When acquiring the current camera mode

Sent command

Command	02	00	20	1C	03	3C
Description	STX	Length	Command		ETX	Sum

Received command

You can see that the camera mode is 0000 = "Hi-res" mode

Command	02	01	20	01	00	00	03	3A
Description	STX	Length	Command		Camera mode		ETX	Sum

Send setting command

- When changing the shutter time to 5000 µs (5 ms)

Sent command (Change setting)

Enter 5000/5 = 1000 as a hexadecimal value for the shutter speed.

Command	02	01	20	0e	03	E8	03	C4
Description	STX	Length	Command		Shutter speed		ETX	Sum

Received command

When the setting is changed correctly, the sent command is returned as-is.

Command	02	00	20	0e	03	2F
Description	STX	Length	Command		ETX	Sum

Sent command (Writing settings to EEPROM)

Command	02	01	00	05	00	00	03	04
Description	STX	Length	Command		Bank number		ETX	Sum

Serial Communication

Received command

Command	02	01	00	05	03	04
Description	STX	Length	Command		ETX	Sum

Tips:

- The settings will be changed when the Profiler 2 receives the command. However, the changed settings will be erased when the power is turned off. To keep the settings, send the command to write them to EEPROM.

Reply when an error occurs

Function	Length	Command (hex)	Data string	Cause of error
No corresponding command	0	e001	—	The corresponding command could not be found.
Invalid parameter	0	e002	—	A parameter specified by the command was invalid.
Invalid packet or time-out	0	e003	—	STX, ETX, or the packet length was invalid or a reception time-out has occurred.
Checksum error	0	e004	—	A BCC calculation mismatch has occurred.
8-bit frame error	0	e005	—	The stop bit could not be detected.
Flash comparison error	0	e006	—	A data mismatch has occurred during a flash writing inspection.
Collision error	0	e007	—	The half-duplex communication procedure was not followed.
Execution error	0	e008	—	A command that cannot be executed was sent during measurement.

8.5.2 Writing Settings to EEPROM

Function	Set or acquire	Send or reply	Length	Command (hex)	Data string	Parameter
Send Param	Set	Send	1	0005	000a	a: Bank number
		Reply	1		000a	0-7, 15 (common settings)

8.5.3 Camera Settings

Function	Set or acquire	Send or reply	Length	Command (hex)	Data string	Parameter										
Camera mode	Set	Send	1	201b	000a	a: Output										
		Reply	0		—	<table border="1"> <thead> <tr> <th>a</th> <th>Setting value</th> <th>a</th> <th>Setting value</th> </tr> </thead> <tbody> <tr> <td>0</td> <td>Hi-res</td> <td>2</td> <td>HDR</td> </tr> <tr> <td>1</td> <td>Hi-spd</td> <td>3</td> <td>NR</td> </tr> </tbody> </table>	a	Setting value	a	Setting value	0	Hi-res	2	HDR	1	Hi-spd
	a	Setting value	a	Setting value												
	0	Hi-res	2	HDR												
1	Hi-spd	3	NR													
Acquire	Send	0	201c	—												
	Reply	1		000a												

Function	Set or acquire	Send or reply	Length	Command (hex)	Data string	Parameter																												
Camera area	Set	Send	4	2000	aaaabbbbccccdddd	The value is the number of CMOS pixels × 8. <table border="1" data-bbox="965 376 1471 611"> <thead> <tr> <th></th> <th></th> <th>Input value</th> </tr> </thead> <tbody> <tr> <td>aaaa</td> <td>Upper coordinate</td> <td>0 to 102</td> </tr> <tr> <td>bbbb</td> <td>Left coordinate</td> <td>0 to 102</td> </tr> <tr> <td>cccc</td> <td>Height</td> <td>2 to 104</td> </tr> <tr> <td>dddd</td> <td>Width</td> <td>2 to 104</td> </tr> </tbody> </table>			Input value	aaaa	Upper coordinate	0 to 102	bbbb	Left coordinate	0 to 102	cccc	Height	2 to 104	dddd	Width	2 to 104													
					Input value																													
	aaaa	Upper coordinate	0 to 102																															
	bbbb	Left coordinate	0 to 102																															
cccc	Height	2 to 104																																
dddd	Width	2 to 104																																
Reply	0	—																																
Acquire	Send	0	2001	—																														
	Reply	4		aaaabbbbccccdddd																														
Auto adjust	Set	Send	0	201a	—	(Execute the automatic adjustment.)																												
		Reply	0		—																													
Gain	Set	Send	1	2002	000a	a: Gain <table border="1" data-bbox="965 779 1471 1108"> <thead> <tr> <th>a</th> <th>Setting value</th> <th>a</th> <th>Setting value</th> </tr> </thead> <tbody> <tr> <td>0</td> <td>1.00</td> <td>6</td> <td>2.67</td> </tr> <tr> <td>1</td> <td>1.14</td> <td>7</td> <td>3.20</td> </tr> <tr> <td>2</td> <td>1.33</td> <td>8</td> <td>4.00</td> </tr> <tr> <td>3</td> <td>1.60</td> <td>9</td> <td>5.33</td> </tr> <tr> <td>4</td> <td>2.00</td> <td>10</td> <td>8.00</td> </tr> <tr> <td>5</td> <td>2.29</td> <td></td> <td></td> </tr> </tbody> </table>	a	Setting value	a	Setting value	0	1.00	6	2.67	1	1.14	7	3.20	2	1.33	8	4.00	3	1.60	9	5.33	4	2.00	10	8.00	5	2.29		
		a	Setting value		a		Setting value																											
	0	1.00	6	2.67																														
	1	1.14	7	3.20																														
	2	1.33	8	4.00																														
	3	1.60	9	5.33																														
4	2.00	10	8.00																															
5	2.29																																	
Reply	0	—																																
Acquire	Send	0	2003	—																														
	Reply	1		000a																														
Shutter	Set	Send	1	200e	0aaa	aaa: Shutter time 1 to 2047 * Setting value × 5 μs (5 to 10235 μs)																												
		Reply	0		—																													
	Acquire	Send	0	200f	—																													
		Reply	1		0aaa																													
HDR shutter	Set	Send	1	2010	0aaa	aaa: Shutter time 1 to 2047 * Setting value × 5 μs (5 to 10235 μs)																												
		Reply	0		—																													
	Acquire	Send	0	2011	—																													
		Reply	1		0aaa																													
Threshold	Set	Send	1	4000	0aaa	aa: Light amount threshold 0 to 255																												
		Reply	0		—																													
	Acquire	Send	0	4001	—																													
		Reply	1		0aaa																													
Reject level	Set	Send	1	4004	0aaa	aa: Waveform extraction level 0 to 127																												
		Reply	0		—																													
	Acquire	Send	0	4005	—																													
		Reply	1		0aaa																													

Serial Communication

8.5.4 Profile Settings

Function	Set or acquire	Send or reply	Length	Command (hex)	Data string	Parameter																				
Target	Set	Send	1	4002	000a	a: Measurement target <table border="1"> <thead> <tr> <th>a</th> <th>Setting value</th> <th>a</th> <th>Setting value</th> </tr> </thead> <tbody> <tr> <td>0</td> <td>Normal</td> <td>2</td> <td>Semi-trans</td> </tr> <tr> <td>1</td> <td>Gap</td> <td></td> <td></td> </tr> </tbody> </table>	a	Setting value	a	Setting value	0	Normal	2	Semi-trans	1	Gap										
		a	Setting value	a	Setting value																					
	0	Normal	2	Semi-trans																						
	1	Gap																								
Reply	0		–																							
Acquire	Send	0	4003	–																						
	Reply	1		000a																						
Alarm limit	Set	Send	1	4008	000a	a: Alarm limit <table border="1"> <thead> <tr> <th>a</th> <th>Setting value</th> <th>a</th> <th>Setting value</th> </tr> </thead> <tbody> <tr> <td>0</td> <td>Normal</td> <td>15</td> <td>Hold operation</td> </tr> <tr> <td>1 to 14</td> <td>Number of values to hold</td> <td></td> <td></td> </tr> </tbody> </table>	a	Setting value	a	Setting value	0	Normal	15	Hold operation	1 to 14	Number of values to hold										
		a	Setting value	a	Setting value																					
	0	Normal	15	Hold operation																						
	1 to 14	Number of values to hold																								
Reply	0		–																							
Acquire	Send	0	4009	–																						
	Reply	1		000a																						
Smoothing	Set	Send	1	4006	000a	a: Smoothing <table border="1"> <thead> <tr> <th>a</th> <th>Setting value</th> <th>a</th> <th>Setting value</th> </tr> </thead> <tbody> <tr> <td>0</td> <td>1</td> <td>4</td> <td>16</td> </tr> <tr> <td>1</td> <td>2</td> <td>5</td> <td>32</td> </tr> <tr> <td>2</td> <td>4</td> <td>6</td> <td>64</td> </tr> <tr> <td>3</td> <td>8</td> <td>7</td> <td>128</td> </tr> </tbody> </table>	a	Setting value	a	Setting value	0	1	4	16	1	2	5	32	2	4	6	64	3	8	7	128
		a	Setting value	a	Setting value																					
	0	1	4	16																						
	1	2	5	32																						
2	4	6	64																							
3	8	7	128																							
Reply	0		–																							
Acquire	Send	0	4007	–																						
	Reply	1		000a																						
Correct method	Set	Send	1	4013	0aaa	a: Smoothing <table border="1"> <thead> <tr> <th>a</th> <th>Setting value</th> <th>a</th> <th>Setting value</th> </tr> </thead> <tbody> <tr> <td>0</td> <td>–</td> <td>3</td> <td>↑→</td> </tr> <tr> <td>1</td> <td>→</td> <td>4</td> <td>↑←</td> </tr> <tr> <td>2</td> <td>←</td> <td>5</td> <td>↑</td> </tr> </tbody> </table>	a	Setting value	a	Setting value	0	–	3	↑→	1	→	4	↑←	2	←	5	↑				
		a	Setting value	a	Setting value																					
	0	–	3	↑→																						
	1	→	4	↑←																						
2	←	5	↑																							
Reply	0		–																							
Acquire	Send	0	4014	–																						
	Reply	1		0aaa																						
H correct	Set	Send	1	4015	aaaa	aaaa: Position correction reference height -14000 to +14000 (×2)																				
		Reply	0		–																					
	Acquire	Send	0	4016	–																					
		Reply	1		aaaa																					
V correct	Set	Send	1	4017	aaaa	aaaa: Height correction reference position -7500 to +7499 (×2)																				
		Reply	0		–																					
	Acquire	Send	0	4018	–																					
		Reply	1		aaaa																					
Tilt correct	Set	Send	1	4010	0aaa	a: ON/OFF status of tilt correction <table border="1"> <thead> <tr> <th>a</th> <th>Setting value</th> </tr> </thead> <tbody> <tr> <td>0</td> <td>OFF</td> </tr> <tr> <td>1</td> <td>ON</td> </tr> </tbody> </table>	a	Setting value	0	OFF	1	ON														
		a	Setting value																							
	0	OFF																								
	1	ON																								
Reply	0		–																							
Acquire	Send	0	4011	–																						
	Reply	1		0aaa																						

Function	Set or acquire	Send or reply	Length	Command (hex)	Data string	Parameter
Tilt cor pos	Set	Send	1	4019	aaaa	aaaa: Tilt correction reference position -7499 to +7500 (×2)
		Reply	0		—	
	Acquire	Send	0	401a	—	
		Reply	1		aaaa	
Save master	Register	Send	0	401b	—	Register the current profile as the master image.
		Reply	0		—	
Master image	Register	Send	0	0014	—	aaaabbbb: Address of the master profile (“aaaa” is the upper part and “bbbb” is the lower part)
		Reply	0		—	
	Acquire	Send	0	0015	—	
		Reply	2		aaaabbbb	

8.5.5 Area Settings

Function	Set or acquire	Send or reply	Length	Command (hex)	Data string	Parameter												
Coverage	Set	Send	5	6002	000abbbbccccddddeeee	a: Area												
		Reply	0		—	<table border="1"> <thead> <tr> <th>a</th> <th>Setting value</th> <th>a</th> <th>Setting value</th> </tr> </thead> <tbody> <tr> <td>0</td> <td>Area1</td> <td>2</td> <td>Area3</td> </tr> <tr> <td>1</td> <td>Area2</td> <td>3</td> <td>Area4</td> </tr> </tbody> </table>	a	Setting value	a	Setting value	0	Area1	2	Area3	1	Area2	3	Area4
	a	Setting value	a	Setting value														
	0	Area1	2	Area3														
1	Area2	3	Area4															
Acquire	Send	1	6003	000a	bbbccccddddeeee: a: Area													
	Reply	4		bbbccccddddeeee	<table border="1"> <thead> <tr> <th></th> <th>Details</th> <th>Input value</th> </tr> </thead> <tbody> <tr> <td>bbbb</td> <td>Upper coordinate</td> <td>-13999 to +13743</td> </tr> <tr> <td>cccc</td> <td>Left coordinate</td> <td>-7499 to +7243</td> </tr> <tr> <td>dddd</td> <td>Lower coordinate</td> <td>-13743 to +13999</td> </tr> <tr> <td>eeee</td> <td>Right coordinate</td> <td>-7243 to +7499</td> </tr> </tbody> </table>		Details	Input value	bbbb	Upper coordinate	-13999 to +13743	cccc	Left coordinate	-7499 to +7243	dddd	Lower coordinate	-13743 to +13999	eeee
	Details	Input value																
bbbb	Upper coordinate	-13999 to +13743																
cccc	Left coordinate	-7499 to +7243																
dddd	Lower coordinate	-13743 to +13999																
eeee	Right coordinate	-7243 to +7499																

Serial Communication

Function	Set or acquire	Send or reply	Length	Command (hex)	Data string	Parameter																															
Meas func	Set	Send	2	6000	000a000b	a: Area <table border="1"> <thead> <tr> <th>a</th> <th>Setting value</th> <th>a</th> <th>Setting value</th> </tr> </thead> <tbody> <tr> <td>0</td> <td>Area1</td> <td>2</td> <td>Area3</td> </tr> <tr> <td>1</td> <td>Area2</td> <td>3</td> <td>Area4</td> </tr> </tbody> </table>	a	Setting value	a	Setting value	0	Area1	2	Area3	1	Area2	3	Area4																			
		a	Setting value		a	Setting value																															
	0	Area1	2	Area3																																	
	1	Area2	3	Area4																																	
	Reply	0	—		b: Measurement function <table border="1"> <thead> <tr> <th>a</th> <th>Setting value</th> <th>a</th> <th>Setting value</th> </tr> </thead> <tbody> <tr> <td>0</td> <td>Average</td> <td>7</td> <td>EdgeCount</td> </tr> <tr> <td>1</td> <td>P height</td> <td>8</td> <td>Tilt</td> </tr> <tr> <td>2</td> <td>B height</td> <td>9</td> <td>Size</td> </tr> <tr> <td>3</td> <td>Width</td> <td>10</td> <td>Length</td> </tr> <tr> <td>4</td> <td>P pos</td> <td>11</td> <td>Diameter</td> </tr> <tr> <td>5</td> <td>B pos</td> <td></td> <td></td> </tr> <tr> <td>6</td> <td>Edge pos</td> <td></td> <td></td> </tr> </tbody> </table>	a	Setting value	a	Setting value	0	Average	7	EdgeCount	1	P height	8	Tilt	2	B height	9	Size	3	Width	10	Length	4	P pos	11	Diameter	5	B pos			6	Edge pos		
	a	Setting value	a	Setting value																																	
0	Average	7	EdgeCount																																		
1	P height	8	Tilt																																		
2	B height	9	Size																																		
3	Width	10	Length																																		
4	P pos	11	Diameter																																		
5	B pos																																				
6	Edge pos																																				
Acquire	Send	1	6001	000a																																	
	Reply	1		000b																																	
Edge dir H	Set	Send	2	600d	000a000b	a: Area <table border="1"> <thead> <tr> <th>a</th> <th>Setting value</th> <th>a</th> <th>Setting value</th> </tr> </thead> <tbody> <tr> <td>0</td> <td>Area1</td> <td>2</td> <td>Area3</td> </tr> <tr> <td>1</td> <td>Area2</td> <td>3</td> <td>Area4</td> </tr> </tbody> </table>	a	Setting value	a	Setting value	0	Area1	2	Area3	1	Area2	3	Area4																			
		a	Setting value		a	Setting value																															
	0	Area1	2	Area3																																	
	1	Area2	3	Area4																																	
Reply	0	—																																			
Acquire	Send	1	600e	000a	b: Edge horizontal direction <table border="1"> <thead> <tr> <th>b</th> <th>Setting value</th> </tr> </thead> <tbody> <tr> <td>0</td> <td>←</td> </tr> <tr> <td>1</td> <td>→</td> </tr> </tbody> </table>	b	Setting value	0	←	1	→																										
	b	Setting value																																			
0	←																																				
1	→																																				
Reply	1	000b																																			
Inflect Threshold	Set	Send	2	6004	000abbbb	a: Area <table border="1"> <thead> <tr> <th>a</th> <th>Setting value</th> <th>a</th> <th>Setting value</th> </tr> </thead> <tbody> <tr> <td>0</td> <td>Area1</td> <td>2</td> <td>Area3</td> </tr> <tr> <td>1</td> <td>Area2</td> <td>3</td> <td>Area4</td> </tr> </tbody> </table>	a	Setting value	a	Setting value	0	Area1	2	Area3	1	Area2	3	Area4																			
		a	Setting value		a	Setting value																															
	0	Area1	2	Area3																																	
	1	Area2	3	Area4																																	
Reply	0	—																																			
Acquire	Send	1	6005	000a	bbbb: Inflect Threshold -255 ~ +255																																
	Reply	1		bbbb																																	

Function	Set or acquire	Send or reply	Length	Command (hex)	Data string	Parameter												
Direction	Set	Send	2	600f	000a000b	a: Area <table border="1"> <thead> <tr> <th>a</th> <th>Setting value</th> <th>a</th> <th>Setting value</th> </tr> </thead> <tbody> <tr> <td>0</td> <td>Area1</td> <td>2</td> <td>Area3</td> </tr> <tr> <td>1</td> <td>Area2</td> <td>3</td> <td>Area4</td> </tr> </tbody> </table>	a	Setting value	a	Setting value	0	Area1	2	Area3	1	Area2	3	Area4
		a	Setting value		a		Setting value											
	0	Area1	2	Area3														
	1	Area2	3	Area4														
Reply	0	–																
Acquire	Send	1	6010	000a	b: Measurement direction <table border="1"> <thead> <tr> <th>b</th> <th>Setting value</th> </tr> </thead> <tbody> <tr> <td>0</td> <td>↑</td> </tr> <tr> <td>1</td> <td>↓</td> </tr> </tbody> </table>	b	Setting value	0	↑	1	↓							
	b	Setting value																
0	↑																	
1	↓																	
Reply	1	000b																
Correction	Set	Send	2	6011	000a000b	a: Area <table border="1"> <thead> <tr> <th>a</th> <th>Setting value</th> <th>a</th> <th>Setting value</th> </tr> </thead> <tbody> <tr> <td>0</td> <td>Area1</td> <td>2</td> <td>Area3</td> </tr> <tr> <td>1</td> <td>Area2</td> <td>3</td> <td>Area4</td> </tr> </tbody> </table>	a	Setting value	a	Setting value	0	Area1	2	Area3	1	Area2	3	Area4
		a	Setting value		a		Setting value											
	0	Area1	2	Area3														
	1	Area2	3	Area4														
Reply	0	–																
Acquire	Send	1	6012	000a	b: Measurement direction <table border="1"> <thead> <tr> <th>b</th> <th>Setting value</th> </tr> </thead> <tbody> <tr> <td>0</td> <td>OFF</td> </tr> <tr> <td>1</td> <td>ON</td> </tr> </tbody> </table>	b	Setting value	0	OFF	1	ON							
	b	Setting value																
0	OFF																	
1	ON																	
Reply	1	000b																

8.5.6 Calculation Settings

Function	Set or acquire	Send or reply	Length	Command (hex)	Data string	Parameter																
Span	Set	Send	2	8012	000a0bbb	a: Area/calculation <table border="1"> <thead> <tr> <th>a</th> <th>Setting value</th> <th>a</th> <th>Setting value</th> </tr> </thead> <tbody> <tr> <td>0</td> <td>Area1</td> <td>3</td> <td>Area4</td> </tr> <tr> <td>1</td> <td>Area2</td> <td>4</td> <td>Calc1</td> </tr> <tr> <td>2</td> <td>Area3</td> <td>5</td> <td>Calc2</td> </tr> </tbody> </table>	a	Setting value	a	Setting value	0	Area1	3	Area4	1	Area2	4	Calc1	2	Area3	5	Calc2
		a	Setting value		a		Setting value															
	0	Area1	3	Area4																		
	1	Area2	4	Calc1																		
2	Area3	5	Calc2																			
Reply	0	–																				
Acquire	Send	1	8013	000a	0bbb: Span 0000 to 1999 [×0.001]																	
	Reply	1	0bbb																			

Serial Communication

Function	Set or acquire	Send or reply	Length	Command (hex)	Data string	Parameter																												
Average	Set	Send	2	8014	000a000b	a: Area <table border="1"> <thead> <tr> <th>a</th> <th>Setting value</th> <th>a</th> <th>Setting value</th> </tr> </thead> <tbody> <tr> <td>0</td> <td>Area1</td> <td>2</td> <td>Area3</td> </tr> <tr> <td>1</td> <td>Area2</td> <td>3</td> <td>Area4</td> </tr> </tbody> </table> bbb: Number of times to perform the moving average 1 to 1023 [number of times]	a	Setting value	a	Setting value	0	Area1	2	Area3	1	Area2	3	Area4																
		a	Setting value		a		Setting value																											
	0	Area1	2	Area3																														
	1	Area2	3	Area4																														
Reply	0	–																																
Acquire	Send	1	8015	000a																														
	Reply	1		000b																														
Hold	Set	Send	2	8016	000a000b	a: Area/calculation <table border="1"> <thead> <tr> <th>a</th> <th>Setting value</th> <th>a</th> <th>Setting value</th> </tr> </thead> <tbody> <tr> <td>0</td> <td>Area1</td> <td>3</td> <td>Area4</td> </tr> <tr> <td>1</td> <td>Area2</td> <td>4</td> <td>Calc1</td> </tr> <tr> <td>2</td> <td>Area3</td> <td>5</td> <td>Calc2</td> </tr> </tbody> </table> b: Hold operation <table border="1"> <thead> <tr> <th>b</th> <th>Setting value</th> <th>b</th> <th>Setting value</th> </tr> </thead> <tbody> <tr> <td>0</td> <td>None</td> <td>2</td> <td>Peak</td> </tr> <tr> <td>1</td> <td>Sample</td> <td>3</td> <td>Bottom</td> </tr> </tbody> </table>	a	Setting value	a	Setting value	0	Area1	3	Area4	1	Area2	4	Calc1	2	Area3	5	Calc2	b	Setting value	b	Setting value	0	None	2	Peak	1	Sample	3	Bottom
		a	Setting value		a		Setting value																											
	0	Area1	3	Area4																														
	1	Area2	4	Calc1																														
2	Area3	5	Calc2																															
b	Setting value	b	Setting value																															
0	None	2	Peak																															
1	Sample	3	Bottom																															
Reply	0	–																																
Acquire	Send	1	8017	000a																														
	Reply	1		000b																														
Calc target1	Set	Send	2	8002	000a000b	a: Calculation <table border="1"> <thead> <tr> <th>a</th> <th>Setting value</th> <th>a</th> <th>Setting value</th> </tr> </thead> <tbody> <tr> <td>4</td> <td>Calc1</td> <td>5</td> <td>Calc2</td> </tr> </tbody> </table> b: Measurement direction <table border="1"> <thead> <tr> <th>b</th> <th>Setting value</th> <th>b</th> <th>Setting value</th> </tr> </thead> <tbody> <tr> <td>0</td> <td>Area1</td> <td>2</td> <td>Area3</td> </tr> <tr> <td>1</td> <td>Area2</td> <td>3</td> <td>Area4</td> </tr> </tbody> </table>	a	Setting value	a	Setting value	4	Calc1	5	Calc2	b	Setting value	b	Setting value	0	Area1	2	Area3	1	Area2	3	Area4								
		a	Setting value		a		Setting value																											
	4	Calc1	5	Calc2																														
	b	Setting value	b	Setting value																														
0	Area1	2	Area3																															
1	Area2	3	Area4																															
Reply	0	–																																
Acquire	Send	1	8003	000a																														
	Reply	1		000b																														
Operator	Set	Send	2	8006	000a000b	a: Calculation <table border="1"> <thead> <tr> <th>a</th> <th>Setting value</th> <th>a</th> <th>Setting value</th> </tr> </thead> <tbody> <tr> <td>4</td> <td>Calc1</td> <td>5</td> <td>Calc2</td> </tr> </tbody> </table> b: Operator <table border="1"> <thead> <tr> <th>b</th> <th>Setting value</th> <th>b</th> <th>Setting value</th> </tr> </thead> <tbody> <tr> <td>0</td> <td>+</td> <td>1</td> <td>–</td> </tr> </tbody> </table>	a	Setting value	a	Setting value	4	Calc1	5	Calc2	b	Setting value	b	Setting value	0	+	1	–												
		a	Setting value		a		Setting value																											
	4	Calc1	5	Calc2																														
	b	Setting value	b	Setting value																														
0	+	1	–																															
Reply	0	–																																
Acquire	Send	1	8007	000a																														
	Reply	1		000b																														

Function	Set or acquire	Send or reply	Length	Command (hex)	Data string	Parameter									
Calc target2	Set	Send	2	8004	000a000b	a: Calculation									
		Reply	0		—	<table border="1"> <thead> <tr> <th>a</th> <th>Setting value</th> <th>a</th> <th>Setting value</th> </tr> </thead> <tbody> <tr> <td>4</td> <td>Calc1</td> <td>5</td> <td>Calc2</td> </tr> </tbody> </table>	a	Setting value	a	Setting value	4	Calc1	5	Calc2	
	a	Setting value	a	Setting value											
	4	Calc1	5	Calc2											
Acquire	Send	1	8005	000a	b: Area										
	Reply	1		000b	<table border="1"> <thead> <tr> <th>b</th> <th>Setting value</th> <th>b</th> <th>Setting value</th> </tr> </thead> <tbody> <tr> <td>0</td> <td>Area1</td> <td>2</td> <td>Area3</td> </tr> <tr> <td>1</td> <td>Area2</td> <td>3</td> <td>Area4</td> </tr> </tbody> </table>	b	Setting value	b	Setting value	0	Area1	2	Area3	1	Area2
b	Setting value	b	Setting value												
0	Area1	2	Area3												
1	Area2	3	Area4												

8.5.7 Output Settings

Function	Set or acquire	Send or reply	Length	Command (hex)	Data string	Parameter													
Out target	Set	Send	2	a00e	000a000b	a: Output													
		Reply	0		—	<table border="1"> <thead> <tr> <th>a</th> <th>Setting value</th> <th>a</th> <th>Setting value</th> </tr> </thead> <tbody> <tr> <td>0</td> <td>OUT1</td> <td>2</td> <td>OUT3</td> </tr> <tr> <td>1</td> <td>OUT2</td> <td>3</td> <td>OUTA</td> </tr> </tbody> </table>	a	Setting value	a	Setting value	0	OUT1	2	OUT3	1	OUT2	3	OUTA	
	a	Setting value	a	Setting value															
	0	OUT1	2	OUT3															
1	OUT2	3	OUTA																
Acquire	Send	1	a00f	000a	b: Output target														
	Reply	1		000b	<table border="1"> <thead> <tr> <th>b</th> <th>Setting value</th> <th>b</th> <th>Setting value</th> </tr> </thead> <tbody> <tr> <td>0</td> <td>Area1</td> <td>3</td> <td>Area4</td> </tr> <tr> <td>1</td> <td>Area2</td> <td>4</td> <td>Calc1</td> </tr> <tr> <td>2</td> <td>Area3</td> <td>5</td> <td>Calc2</td> </tr> </tbody> </table>	b	Setting value	b	Setting value	0	Area1	3	Area4	1	Area2	4	Calc1	2	Area3
b	Setting value	b	Setting value																
0	Area1	3	Area4																
1	Area2	4	Calc1																
2	Area3	5	Calc2																
Upper limit (OUT1 to OUT3) 20mA (OUTA)	Set	Send	2	a00a	000abbbb	a: Output													
		Reply	0		—	<table border="1"> <thead> <tr> <th>a</th> <th>Setting value</th> <th>a</th> <th>Setting value</th> </tr> </thead> <tbody> <tr> <td>0</td> <td>OUT1</td> <td>2</td> <td>OUT3</td> </tr> <tr> <td>1</td> <td>OUT2</td> <td>3</td> <td>OUTA</td> </tr> </tbody> </table>	a	Setting value	a	Setting value	0	OUT1	2	OUT3	1	OUT2	3	OUTA	
	a	Setting value	a	Setting value															
	0	OUT1	2	OUT3															
1	OUT2	3	OUTA																
Acquire	Send	1	a00b	000a	bbbb: Upper limit or 20mA value Upper limit: -32766 to +32767 20mA: -31767 to +32767														
	Reply	1		bbbb															

Serial Communication

Function	Set or acquire	Send or reply	Length	Command (hex)	Data string	Parameter																												
Lower limit (OUT1 to OUT3) 4mA (OUTA)	Set	Send	2	a00c	000abbbb	a: Output <table border="1" data-bbox="890 376 1396 517"> <thead> <tr> <th>a</th> <th>Setting value</th> <th>a</th> <th>Setting value</th> </tr> </thead> <tbody> <tr> <td>0</td> <td>Area1</td> <td>2</td> <td>Area3</td> </tr> <tr> <td>1</td> <td>Area2</td> <td>3</td> <td>Area4</td> </tr> </tbody> </table> bbbb: Lower limit or 4mA value Lower limit: -32767 to +32766 4mA: -32767 to +31767	a	Setting value	a	Setting value	0	Area1	2	Area3	1	Area2	3	Area4																
		a	Setting value	a	Setting value																													
	0	Area1	2	Area3																														
	1	Area2	3	Area4																														
Reply	0		–																															
Acquire	Send	1	a00d	000a																														
	Reply	1		bbbb																														
Out action	Set	Send	2	a000	000a000b	a: Output <table border="1" data-bbox="890 701 1396 842"> <thead> <tr> <th>a</th> <th>Setting value</th> <th>a</th> <th>Setting value</th> </tr> </thead> <tbody> <tr> <td>0</td> <td>OUT1</td> <td>2</td> <td>OUT3</td> </tr> <tr> <td>1</td> <td>OUT2</td> <td></td> <td></td> </tr> </tbody> </table> b: Output action <table border="1" data-bbox="890 920 1396 1106"> <thead> <tr> <th>b</th> <th>Setting value</th> <th>b</th> <th>Setting value</th> </tr> </thead> <tbody> <tr> <td>0</td> <td>Normal</td> <td>3</td> <td>Ready</td> </tr> <tr> <td>1</td> <td>1shot</td> <td>4</td> <td>Strobe</td> </tr> <tr> <td>2</td> <td>OnDelay</td> <td>5</td> <td>1shot2</td> </tr> </tbody> </table>	a	Setting value	a	Setting value	0	OUT1	2	OUT3	1	OUT2			b	Setting value	b	Setting value	0	Normal	3	Ready	1	1shot	4	Strobe	2	OnDelay	5	1shot2
		a	Setting value	a	Setting value																													
	0	OUT1	2	OUT3																														
	1	OUT2																																
b	Setting value	b	Setting value																															
0	Normal	3	Ready																															
1	1shot	4	Strobe																															
2	OnDelay	5	1shot2																															
Reply	0		–																															
Acquire	Send	1	a001	000a																														
	Reply	1		000b																														
Out polar	Set	Send	2	a004	000a000b	a: Output <table border="1" data-bbox="890 1178 1396 1319"> <thead> <tr> <th>a</th> <th>Setting value</th> <th>a</th> <th>Setting value</th> </tr> </thead> <tbody> <tr> <td>0</td> <td>OUT1</td> <td>2</td> <td>OUT3</td> </tr> <tr> <td>1</td> <td>OUT2</td> <td></td> <td></td> </tr> </tbody> </table> b: Output polarity <table border="1" data-bbox="890 1397 1142 1538"> <thead> <tr> <th>b</th> <th>Setting value</th> </tr> </thead> <tbody> <tr> <td>0</td> <td>N.O.</td> </tr> <tr> <td>1</td> <td>N.C.</td> </tr> </tbody> </table>	a	Setting value	a	Setting value	0	OUT1	2	OUT3	1	OUT2			b	Setting value	0	N.O.	1	N.C.										
		a	Setting value	a	Setting value																													
	0	OUT1	2	OUT3																														
	1	OUT2																																
b	Setting value																																	
0	N.O.																																	
1	N.C.																																	
Reply	0		–																															
Acquire	Send	1	a005	000a																														
	Reply	1		000b																														
Output time	Set	Send	2	a008	000a0bbb	a: Output <table border="1" data-bbox="890 1610 1396 1751"> <thead> <tr> <th>a</th> <th>Setting value</th> <th>a</th> <th>Setting value</th> </tr> </thead> <tbody> <tr> <td>0</td> <td>OUT1</td> <td>2</td> <td>OUT3</td> </tr> <tr> <td>1</td> <td>OUT2</td> <td></td> <td></td> </tr> </tbody> </table> bbb: Output time 1 to 2047 [$\times 0.1$ ms]	a	Setting value	a	Setting value	0	OUT1	2	OUT3	1	OUT2																		
		a	Setting value	a	Setting value																													
	0	OUT1	2	OUT3																														
	1	OUT2																																
Reply	0		–																															
Acquire	Send	1	a009	000a																														
	Reply	1		0bbb																														

Function	Set or acquire	Send or reply	Length	Command (hex)	Data string	Parameter																																			
Output value	Set	Send	2	a013	000a0bbb	a: Output <table border="1"> <thead> <tr> <th>a</th> <th>Setting value</th> <th>a</th> <th>Setting value</th> </tr> </thead> <tbody> <tr> <td>0</td> <td>OUT1</td> <td>2</td> <td>OUT3</td> </tr> <tr> <td>1</td> <td>OUT2</td> <td></td> <td></td> </tr> </tbody> </table>	a	Setting value	a	Setting value	0	OUT1	2	OUT3	1	OUT2																									
		a	Setting value		a		Setting value																																		
	0	OUT1	2	OUT3																																					
	1	OUT2																																							
Reply	0	–																																							
Acquire	Send	1	a014	000a	bbbb: Offset value -32767 to +32767 [$\times 0.01$ mm]																																				
	Reply	1		bbbb																																					
Hysteresis	Set	Send	2	a018	000a000b	a: Output <table border="1"> <thead> <tr> <th>a</th> <th>Setting value</th> <th>a</th> <th>Setting value</th> </tr> </thead> <tbody> <tr> <td>0</td> <td>OUT1</td> <td>2</td> <td>OUT3</td> </tr> <tr> <td>1</td> <td>OUT2</td> <td></td> <td></td> </tr> </tbody> </table>	a	Setting value	a	Setting value	0	OUT1	2	OUT3	1	OUT2																									
		a	Setting value		a		Setting value																																		
	0	OUT1	2	OUT3																																					
	1	OUT2																																							
	Reply	0	1																																						
	Acquire	Send	1	a019	000a	b: Hysteresis <table border="1"> <thead> <tr> <th>b</th> <th>Setting value</th> <th>b</th> <th>Setting value</th> </tr> </thead> <tbody> <tr> <td>0</td> <td>0</td> <td>8</td> <td>150</td> </tr> <tr> <td>1</td> <td>4</td> <td>9</td> <td>200</td> </tr> <tr> <td>2</td> <td>8</td> <td>10</td> <td>300</td> </tr> <tr> <td>3</td> <td>16</td> <td>11</td> <td>500</td> </tr> <tr> <td>4</td> <td>32</td> <td>12</td> <td>750</td> </tr> <tr> <td>5</td> <td>50</td> <td>13</td> <td>1000</td> </tr> <tr> <td>6</td> <td>75</td> <td>14</td> <td>1500</td> </tr> <tr> <td>7</td> <td>100</td> <td>15</td> <td>2000</td> </tr> </tbody> </table>	b	Setting value	b	Setting value	0	0	8	150	1	4	9	200	2	8	10	300	3	16	11	500	4	32	12	750	5	50	13	1000	6	75	14	1500	7	100	15
b		Setting value	b		Setting value																																				
0	0	8	150																																						
1	4	9	200																																						
2	8	10	300																																						
3	16	11	500																																						
4	32	12	750																																						
5	50	13	1000																																						
6	75	14	1500																																						
7	100	15	2000																																						
Reply	1	000b																																							
Offset	Execute	Send	1	a011	000a	a: Output <table border="1"> <thead> <tr> <th>a</th> <th>Setting value</th> <th>a</th> <th>Setting value</th> </tr> </thead> <tbody> <tr> <td>0</td> <td>OUT1</td> <td>2</td> <td>OUT3</td> </tr> <tr> <td>1</td> <td>OUT2</td> <td></td> <td></td> </tr> </tbody> </table>	a	Setting value	a	Setting value	0	OUT1	2	OUT3	1	OUT2																									
		a	Setting value		a		Setting value																																		
0	OUT1	2	OUT3																																						
1	OUT2																																								
Reply	0	–																																							
Clearing offset	Execute	Send	1	a012	000a	<table border="1"> <tbody> <tr> <td>0</td> <td>OUT1</td> <td>2</td> <td>OUT3</td> </tr> <tr> <td>1</td> <td>OUT2</td> <td></td> <td></td> </tr> </tbody> </table>	0	OUT1	2	OUT3	1	OUT2																													
		0	OUT1		2		OUT3																																		
1	OUT2																																								
Reply	1	–																																							

8.5.8 Input Settings

Function	Set or acquire	Send or reply	Length	Command (hex)	Data string	Parameter												
IN1 to IN4 input terminal operation	Set	Send	2	c000	000a000b	a: Input <table border="1"> <thead> <tr> <th>a</th> <th>Setting value</th> <th>a</th> <th>Setting value</th> </tr> </thead> <tbody> <tr> <td>0</td> <td>IN1</td> <td>2</td> <td>IN3</td> </tr> <tr> <td>1</td> <td>IN2</td> <td>3</td> <td>IN4</td> </tr> </tbody> </table>	a	Setting value	a	Setting value	0	IN1	2	IN3	1	IN2	3	IN4
		a	Setting value		a	Setting value												
	0	IN1	2	IN3														
	1	IN2	3	IN4														
	Reply	0	—	b: Input terminal operation IN1 <table border="1"> <thead> <tr> <th>b</th> <th>Setting value</th> <th>b</th> <th>Setting value</th> </tr> </thead> <tbody> <tr> <td>0</td> <td>BANK1</td> <td>1</td> <td>Reset</td> </tr> </tbody> </table>	b	Setting value	b	Setting value	0	BANK1	1	Reset						
	b	Setting value	b	Setting value														
0	BANK1	1	Reset															
Acquire	Send	1	c001	000a	IN2 <table border="1"> <thead> <tr> <th>b</th> <th>Setting value</th> <th>b</th> <th>Setting value</th> </tr> </thead> <tbody> <tr> <td>0</td> <td>BANK2</td> <td>1</td> <td>Hold</td> </tr> </tbody> </table>	b	Setting value	b	Setting value	0	BANK2	1	Hold					
	b	Setting value		b	Setting value													
0	BANK2	1	Hold															
Reply	1	000b	IN3 <table border="1"> <thead> <tr> <th>b</th> <th>Setting value</th> <th>b</th> <th>Setting value</th> </tr> </thead> <tbody> <tr> <td>0</td> <td>BANK3</td> <td>1</td> <td>Trigger</td> </tr> </tbody> </table>	b	Setting value	b	Setting value	0	BANK3	1	Trigger							
b	Setting value	b	Setting value															
0	BANK3	1	Trigger															
IN1 Reset	Execute	Send	0	c009	—													
		Reply	0		—													
Inner hold	Set	Send	1	a015	000a	a: ON/OFF status of hold operation <table border="1"> <thead> <tr> <th>a</th> <th>Setting value</th> </tr> </thead> <tbody> <tr> <td>0</td> <td>OFF</td> </tr> <tr> <td>1</td> <td>ON</td> </tr> </tbody> </table>	a	Setting value	0	OFF	1	ON						
		a	Setting value															
	0	OFF																
	1	ON																
Reply	0	—																
Acquire	Send	0	a016	—														
	Reply	1		000a														
Inner trig	Set	Send	1	c005	000a	a: ON/OFF status of trigger operation <table border="1"> <thead> <tr> <th>a</th> <th>Setting value</th> </tr> </thead> <tbody> <tr> <td>0</td> <td>OFF</td> </tr> <tr> <td>1</td> <td>ON</td> </tr> </tbody> </table>	a	Setting value	0	OFF	1	ON						
		a	Setting value															
	0	OFF																
	1	ON																
Reply	0	—																
Acquire	Send	0	c006	—														
	Reply	1		000a														
Input polar	Set	Send	1	c00a	000a	a: Input polarity <table border="1"> <thead> <tr> <th>a</th> <th>Setting value</th> </tr> </thead> <tbody> <tr> <td>0</td> <td>N.O.</td> </tr> <tr> <td>1</td> <td>N.C.</td> </tr> </tbody> </table>	a	Setting value	0	N.O.	1	N.C.						
		a	Setting value															
	0	N.O.																
	1	N.C.																
Reply	0	—																
Acquire	Send	0	c00b	—														
	Reply	1		000a														

Function	Set or acquire	Send or reply	Length	Command (hex)	Data string	Parameter																
Trig action	Set	Send	1	2006	000a	a: Trigger method <table border="1"> <thead> <tr> <th>a</th> <th>Setting value</th> <th>a</th> <th>Setting value</th> </tr> </thead> <tbody> <tr> <td>0</td> <td>Cont</td> <td>2</td> <td>Count</td> </tr> <tr> <td>1</td> <td>1shot</td> <td></td> <td></td> </tr> </tbody> </table>	a	Setting value	a	Setting value	0	Cont	2	Count	1	1shot						
		a	Setting value		a		Setting value															
	0	Cont	2	Count																		
	1	1shot																				
Reply	0	—																				
Acquire	Send	0	2007	—																		
	Reply	1		000a																		
Trig count	Set	Send	1	2012	aaaa	aaaa: Number of triggers 1 to 4095 [number of times]																
		Reply	0		—																	
	Acquire	Send	0	2013	—																	
		Reply	1		aaaa																	
Inp filter	Set	Send	1	c003	00aa	aa: Input filter time 1 to 255 [$\times 5 \mu\text{s}$]																
		Reply	0		—																	
	Acquire	Send	0	c004	—																	
		Reply	1		00aa																	
Trig delay	Set	Send	1	2014	aaaa	aaa: Trigger delay time 1 to 4095 [$\times 5 \text{ms}$]																
		Reply	0		—																	
	Acquire	Send	0	2015	—																	
		Reply	1		aaaa																	
Offset target	Set	Send	1	c007	000a	• a: Offset target <table border="1"> <thead> <tr> <th>a</th> <th>Setting value</th> <th>a</th> <th>Setting value</th> </tr> </thead> <tbody> <tr> <td>0</td> <td>Indivi</td> <td>3</td> <td>OUT2</td> </tr> <tr> <td>1</td> <td>All</td> <td>4</td> <td>OUT3</td> </tr> <tr> <td>2</td> <td>OUT1</td> <td></td> <td></td> </tr> </tbody> </table>	a	Setting value	a	Setting value	0	Indivi	3	OUT2	1	All	4	OUT3	2	OUT1		
		a	Setting value		a		Setting value															
	0	Indivi	3	OUT2																		
	1	All	4	OUT3																		
2	OUT1																					
Reply	0	—																				
Acquire	Send	0	c008	—																		
	Reply	1		000a																		

8.5.9 Storage Settings

Function	Set or acquire	Send or reply	Length	Command (hex)	Data string	Parameter												
Storage	Set	Send	1	c00e	000a	a: Target data <table border="1"> <thead> <tr> <th>a</th> <th>Setting value</th> <th>a</th> <th>Setting value</th> </tr> </thead> <tbody> <tr> <td>0</td> <td>OFF</td> <td>2</td> <td>Profile</td> </tr> <tr> <td>1</td> <td>Measure</td> <td></td> <td></td> </tr> </tbody> </table>	a	Setting value	a	Setting value	0	OFF	2	Profile	1	Measure		
		a	Setting value		a		Setting value											
	0	OFF	2	Profile														
	1	Measure																
Reply	0	—																
Acquire	Send	0	c00f	—														
	Reply	1		000a														
No.of Data	Set	Send	1	c012	aaaa	aaaa: Number of saved data items Measured value: 1 to 65535 Profile: 1 to 8000												
		Reply	0		—													
	Acquire	Send	0	c013	—													
		Reply	1		aaaa													

Serial Communication

Function	Set or acquire	Send or reply	Length	Command (hex)	Data string	Parameter																		
Start cond	Set	Send	1	c014	000a	a: Start condition <table border="1"> <thead> <tr> <th>a</th> <th>Setting value</th> <th>a</th> <th>Setting value</th> </tr> </thead> <tbody> <tr> <td>0</td> <td>Continue</td> <td>3</td> <td>Alarm</td> </tr> <tr> <td>1</td> <td>Hold in</td> <td>4</td> <td>UP limit</td> </tr> <tr> <td>2</td> <td>Measure</td> <td>5</td> <td>LOW limit</td> </tr> </tbody> </table>	a	Setting value	a	Setting value	0	Continue	3	Alarm	1	Hold in	4	UP limit	2	Measure	5	LOW limit		
		a	Setting value		a		Setting value																	
	0	Continue	3	Alarm																				
	1	Hold in	4	UP limit																				
	2	Measure	5	LOW limit																				
	Reply	0	—																					
Acquire	Send	0	c015	—																				
	Reply	1		000a																				
Start pos	Register	Send	1	c016	aaaa	aaaa: Start position Measured value: -10000 to +10000 Profile: -2000 to +2000																		
		Reply	0		—																			
	Acquire	Send	0	c017	—																			
		Reply	1		aaaa																			
	Start target	Set	Send	1	c018		000a	a: Target area/calculation <table border="1"> <thead> <tr> <th>b</th> <th>Setting value</th> <th>b</th> <th>Setting value</th> </tr> </thead> <tbody> <tr> <td>0</td> <td>Area1</td> <td>3</td> <td>Area4</td> </tr> <tr> <td>1</td> <td>Area2</td> <td>4</td> <td>Calc1</td> </tr> <tr> <td>2</td> <td>Area3</td> <td>5</td> <td>Calc2</td> </tr> </tbody> </table>	b	Setting value	b	Setting value	0	Area1	3	Area4	1	Area2	4	Calc1	2	Area3	5	Calc2
			b	Setting value			b		Setting value															
0		Area1	3	Area4																				
1		Area2	4	Calc1																				
2		Area3	5	Calc2																				
0		—																						
Acquire	Reply	0	c019	—																				
	1	000a																						
Threshold	Set	Send	2	c01a	aaaaaaaaaaaa	aaaaaaaaa: Threshold -999.999 to +999.999																		
		Reply	0		—																			
	Acquire	Send	0	c01b	—																			
		Reply	2		aaaaaaaaaaaa																			
	Intermittent	Set	Send	1	c01c		aaaa	aaaa: Number of thinning 1 to 8191																
			Reply	0			—																	
Acquire		Send	0	c01d	—																			
		Reply	1		aaaa																			
Repeat		Set	Send	1	c01e	000a	a: Specifies whether storage should be restarted after the preset number of data items are stored. <table border="1"> <thead> <tr> <th>a</th> <th>Setting value</th> <th>a</th> <th>Setting value</th> </tr> </thead> <tbody> <tr> <td>0</td> <td>ON</td> <td>2</td> <td>Pause</td> </tr> <tr> <td>1</td> <td>OFF</td> <td></td> <td></td> </tr> </tbody> </table>		a	Setting value	a	Setting value	0	ON	2	Pause	1	OFF						
			a	Setting value		a			Setting value															
	0	ON	2	Pause																				
	1	OFF																						
	Reply	0	—																					
	Acquire	Send	0	c01f	—																			
Reply		1	000a																					

8.5.10 Other Settings

Function	Set or acquire	Send or reply	Length	Command (hex)	Data string	Parameter						
Bank switch	Set	Send	1	0012	000a	a: Bank switching method <table border="1"><thead><tr><th>a</th><th>Setting value</th></tr></thead><tbody><tr><td>0</td><td>In/Para</td></tr><tr><td>1</td><td>Comm</td></tr></tbody></table>	a	Setting value	0	In/Para	1	Comm
		a	Setting value									
	0	In/Para										
	1	Comm										
Reply	0	—										
Acquire	Send	0	0013	—								
	Reply	1		000a								
Bank	Set	Send	1	0006	000a	a: Bank to switch to 0 to 7 * "0" is bank 1 and "7" is bank 8.						
		Reply	0		—							
	Acquire	Send	0	0007	—							
		Reply	1		000a							
Axis dir	Set	Send	1	0018	000a	a: Axis direction <table border="1"><thead><tr><th>a</th><th>Setting value</th></tr></thead><tbody><tr><td>0</td><td>Near+</td></tr><tr><td>1</td><td>Far+</td></tr></tbody></table>	a	Setting value	0	Near+	1	Far+
		a	Setting value									
	0	Near+										
	1	Far+										
Reply	0	—										
Acquire	Send	0	0019	—								
	Reply	1		000a								
On Timing	Set	Send	1	a006	000a	a: Judgment for turning on outputs <table border="1"><thead><tr><th>a</th><th>Setting value</th></tr></thead><tbody><tr><td>0</td><td>Out range</td></tr><tr><td>1</td><td>In range</td></tr></tbody></table>	a	Setting value	0	Out range	1	In range
		a	Setting value									
	0	Out range										
	1	In range										
Reply	0	—										
Acquire	Send	0	a007	—								
	Reply	1		000a								
Initialize	Execute	Send	1	0008	000a	a: Initialization method						
		Reply	0		—							
Version	Acquire	Send	0	0009	—	aaaaaaaaaaaa: Version						
		Reply	3		aaaaaaaaaaaa							

9 Specifications

9.1 Specifications

Model		PR02-N100B25A1 (6052874)	PR02-P100B25A1 (6052873)
Measurement range		100 ± 25 mm	
Field of view (at measuring distance)		17 mm (at 75 mm), 27 mm (at 125 mm)	
Light source		Red laser, wavelength: 655 nm, max. output: 1 mW	
Laser class	IEC/JIS	Class2	
	FDA	CLASS II	
Spot size*1		0.3 × 32 mm	
Linearity	Z axis	0.1% of F.S. (50 µm)	
Resolution*2	Z axis	2 µm	
Resolution*3	X axis	25 µm	
Response time		Typical value: 5 ms (when measuring the whole view in “Hi-res” mode), max. speed: 0.5 ms	
Display		Dot matrix display	
LEDs		Power indicator (green), laser emission indicator (green)	
External input		Selectable from bank, trigger, hold, reset, laser emission stop, and offset	
Control output		3 NPN open collector outputs, max. 100 mA/30 VDC (max. residual voltage: 1.8 V)	3 PNP open collector outputs, max. 100 mA/30 VDC (max. residual voltage: 1.8 V)
Analog output		4 to 20 mA, out of measurement range: 24 mA (max. load impedance: 300 Ω)	
Communication interface		RS-485 half duplex (9.6 kbps to 4.0 Mbps)	
Temperature drift (typical example)		0.05% of F.S./°C	
Power supply voltage		12 to 24 VDC (+10%, -5%, including ripple)	
Current consumption*4		Max. 180 mA	
Protection category		IP67	
Operating temperature/humidity		-10 to +40 °C/35 to 85%RH (no condensation or freezing)	
Storage temperature/humidity		-20 to +60 °C/35 to 85%RH (no condensation or freezing)	
Operating illuminance		Sunlight: 10000 lx or less, high-frequency lamp: 3000 lx or less	
Vibration resistance		10 to 55 Hz; double amplitude 1.5 mm; 2 hours in each of the X, Y, and Z directions	
Shock resistance		Approximately 50 G (500 m/s ²), 3 times in each of the X, Y, and Z directions	
Material		Housing: die-cast zinc and PC, laser emitter and receiver covers: glass	
Weight		Approximately 300 g	

*1 Defined with center strength 1/e² (13.5%) at the center of measurement range. The sensor may be affected when leak light other than that of the specified spot size is present and when there is a highly reflective object close to the detection area.

*2 Average height measurement of a white workpiece with a center width of 5 mm, smoothing performed 8 times, moving average performed 32 times (with the default settings)

*3 With a measurement distance of 75 mm

*4 Power supply voltage: 24 VDC not including the control output load current and including the analog output

9.2 Connection diagram

9.2.1 Input Circuit Diagram

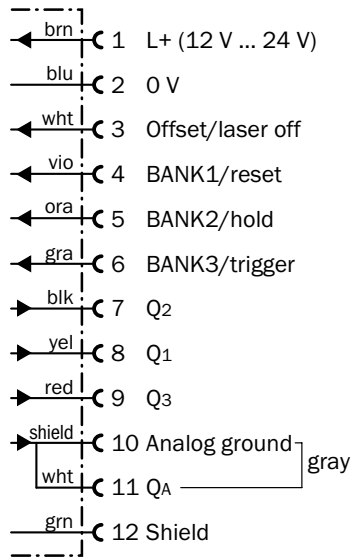
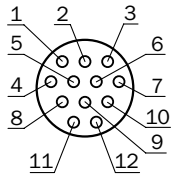

Specifications

9.3 Dimensions

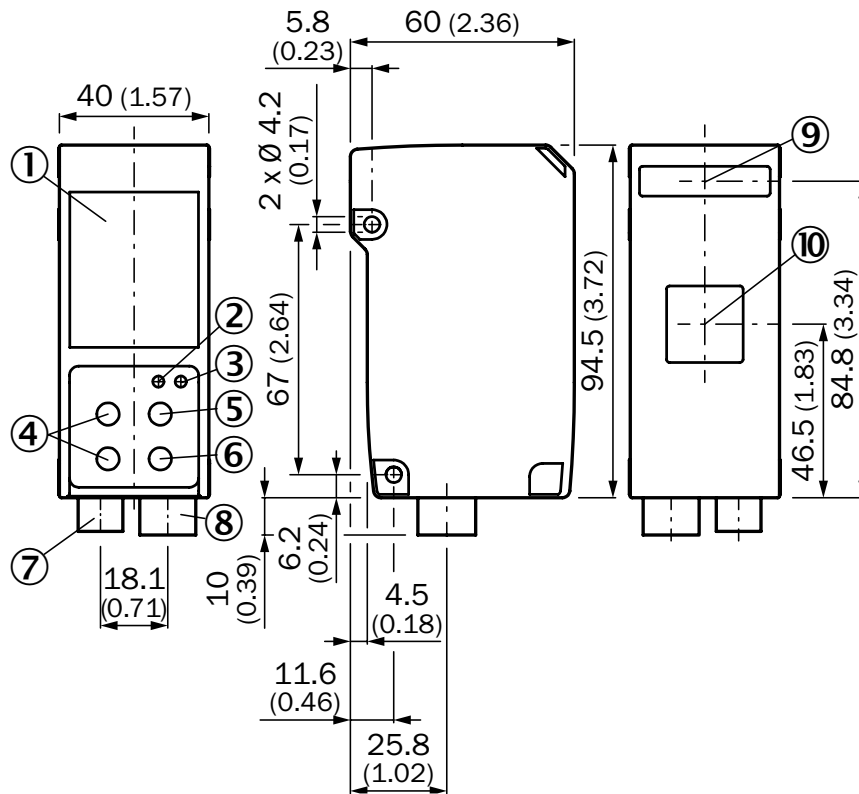

Number	Name
①	LCD display
②	LED Indicator for power on (green)
③	LED Indicator for Laser on (green)
④	Cursor keys
⑤	EXIT button
⑥	SET button
⑦	Connector for communication cable
⑧	Connector for M12, 12-pin cable
⑨	Sender area, z-axis
⑩	Field of view, x-axis

9.4 Timing Charts

This section explains the timing charts of Profiler 2 measurements and output.

9.4.1 Measurement

The timing charts of Profiler 2 measurements are shown below.

Output switching behaviour

Tolerance judgment (upper and lower thresholds and hysteresis)

When "Out polar" is "N.O." and "On Timing" is "Out range"

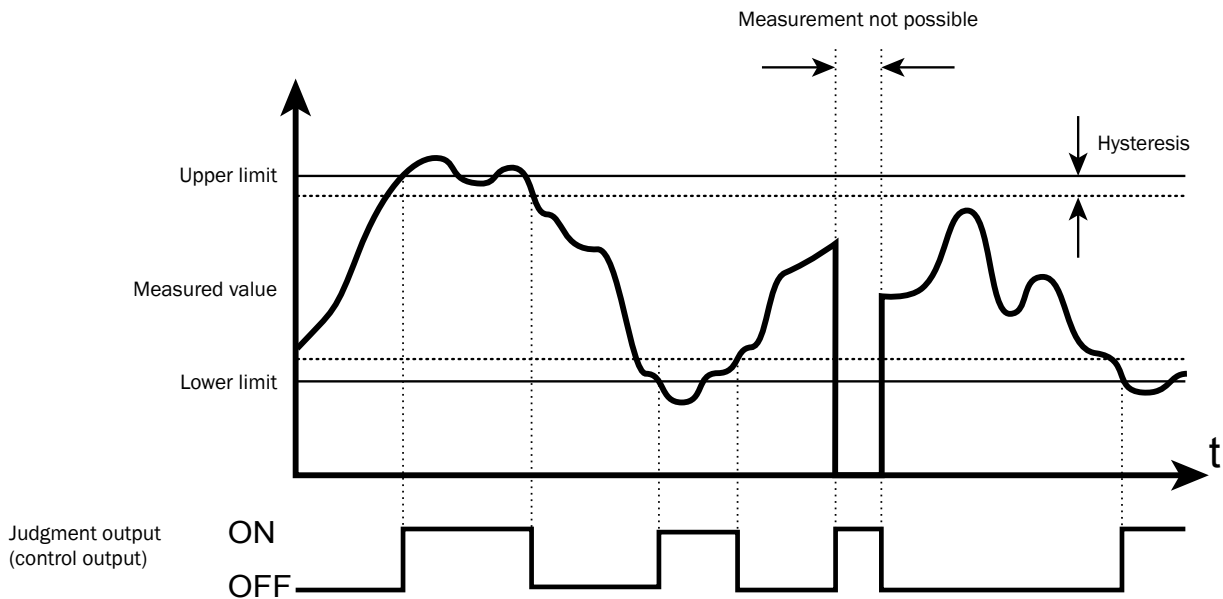

Hold mode

When the hold mode is "None"

When the hold mode is "None," hold input is ignored and the measured result is always updated to the latest value.

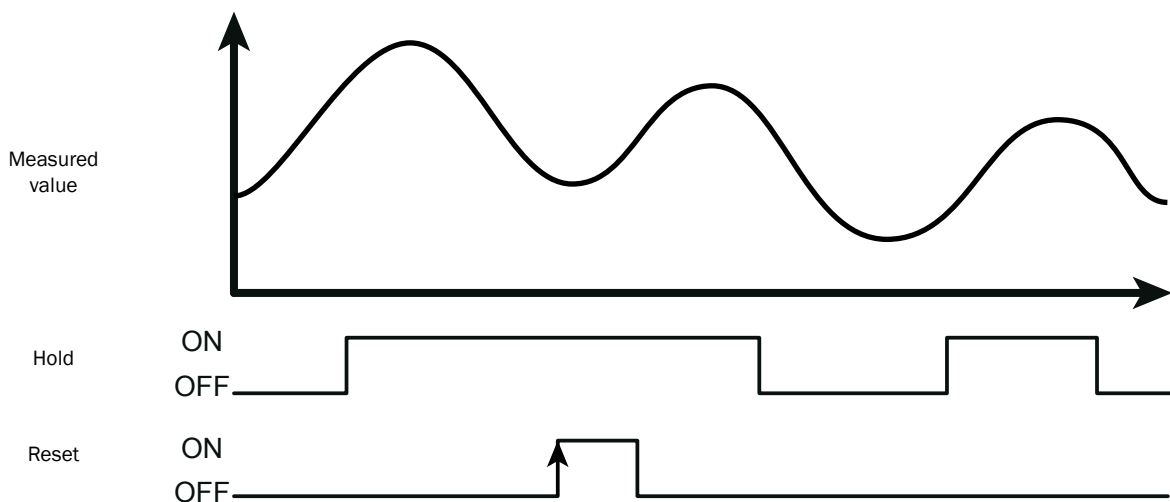

Specifications

When the hold mode is "Sample"

When the hold mode is "Sample," the value present when hold input is received is maintained.

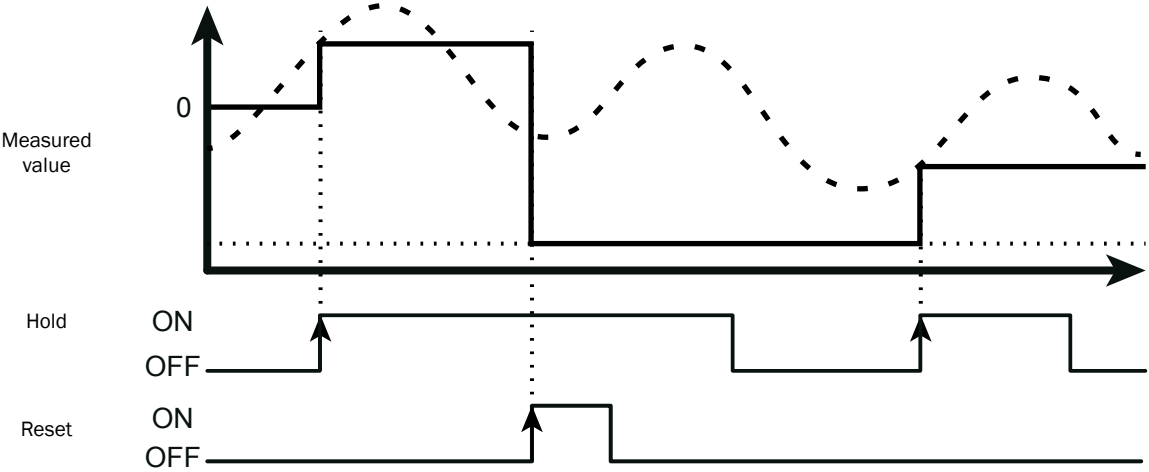

When the hold mode is "Peak"

When the hold mode is "Peak," the maximum value present while hold input is received is acquired.

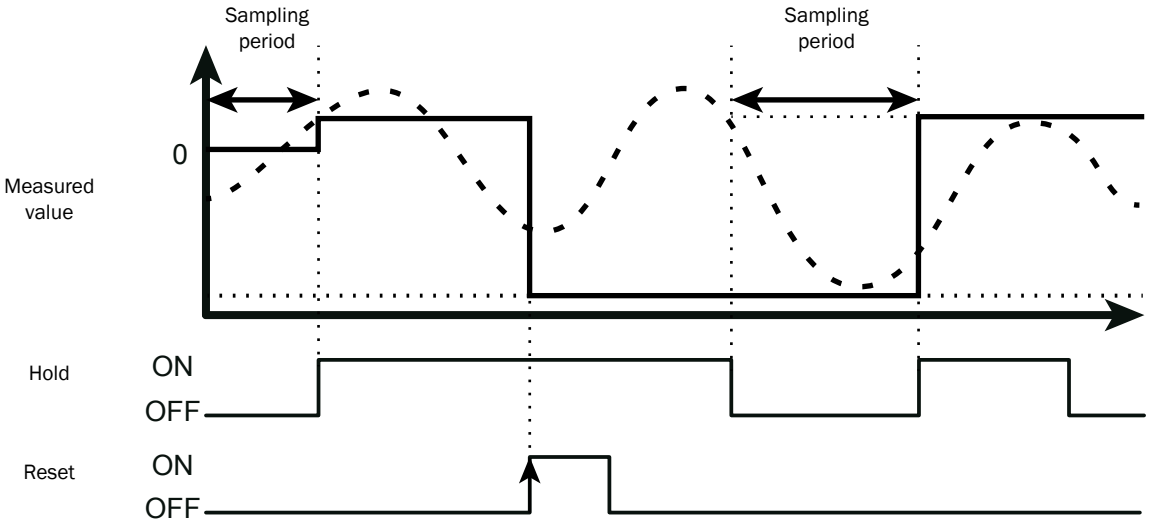

When the hold mode is “Bottom”

When the hold mode is “Bottom,” the minimum value present while hold input is received is acquired.

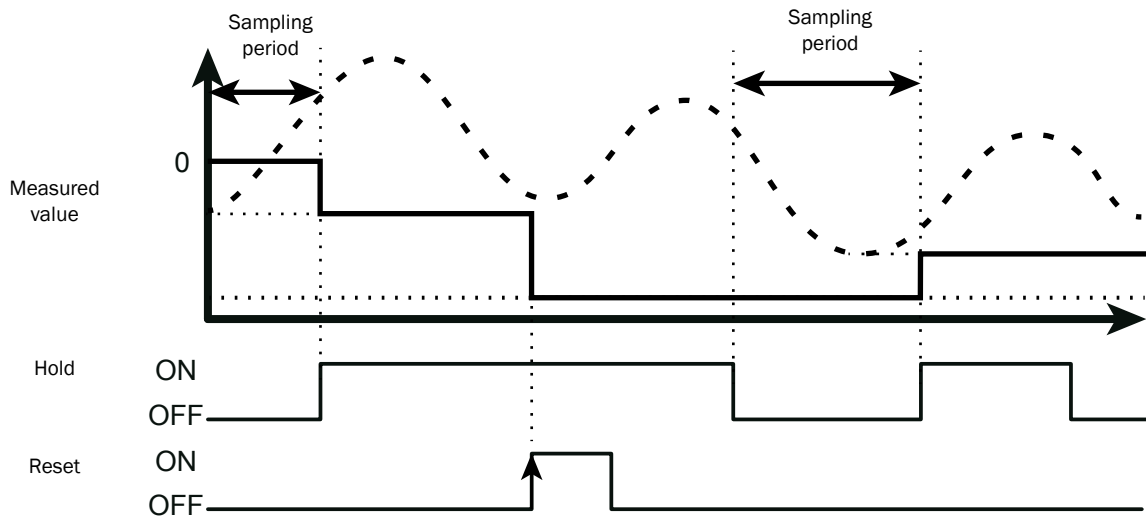

9.4.2 I/O

Trigger

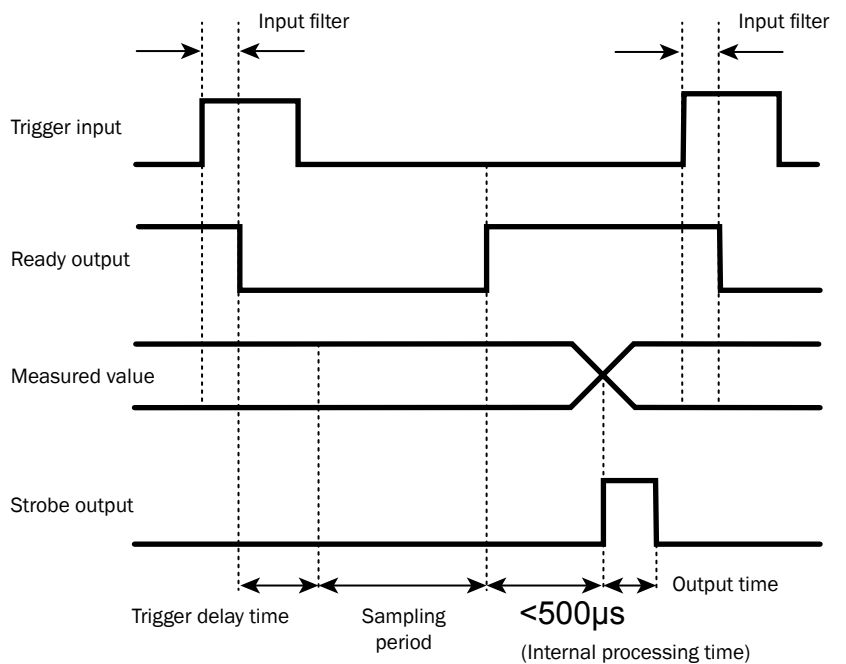

- Tips:*
- When “Trig action” is set to “Cont,” the ready output is not generated.
 - Strobe output is generated when the measured value is updated.
 - Input constant of external input is 150 μs (ON \rightarrow OFF) and 25 μs (OFF \rightarrow ON).

Offset

The offset input operation varies depending on the value of the “Offset target” setting.

The offset input operation is executed when input turns off.

When “Offset target” is “Indivi”

Input time	Operation
230 ms or less	Set the offset on OUT1.
430 ms or less	Set the offset on OUT2.
630 ms or less	Set the offset on OUT3.
830 ms or less	Clear the offset from OUT1.
1030 ms or less	Clear the offset from OUT2.
1230 ms or less	Clear the offset from OUT3.
More than 1230 ms	Clear all the offsets as a batch.

When “Offset target” is “All”

Input time	Operation
330 ms or less	Set the offset on OUT1 to OUT3 as a batch.
More than 330 ms	Clear all the offsets from OUT1 to OUT3 as a batch.

When “Offset target” is “OUT1” to “OUT3”

Input time	Operation
330 ms or less	Set the offset on OUT1, OUT2, or OUT3.
More than 330 ms	Clear the offset from OUT1, OUT2, or OUT3.

Output operation

This section explains the judgment output operation.

The arrows in the figure below represent output time.

When "Trig action" is "Cont"

This is the output operation when "Cont" is set for "Trig action".

The figure shows the case when the output time is longer than the sampling period.

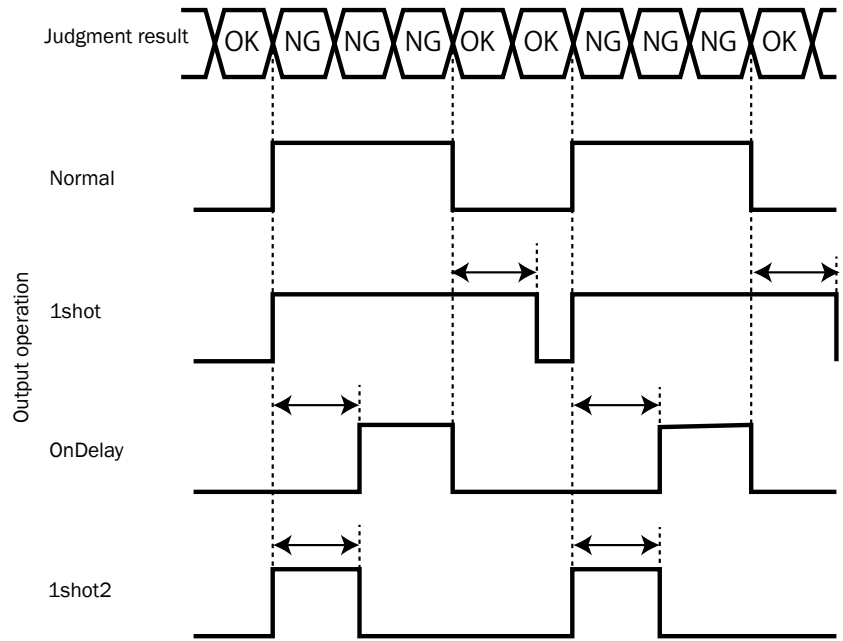

When "Trig action" is "1shot" or "Count"

This is the output operation when "1shot" or "Count" is set for "Trig action".

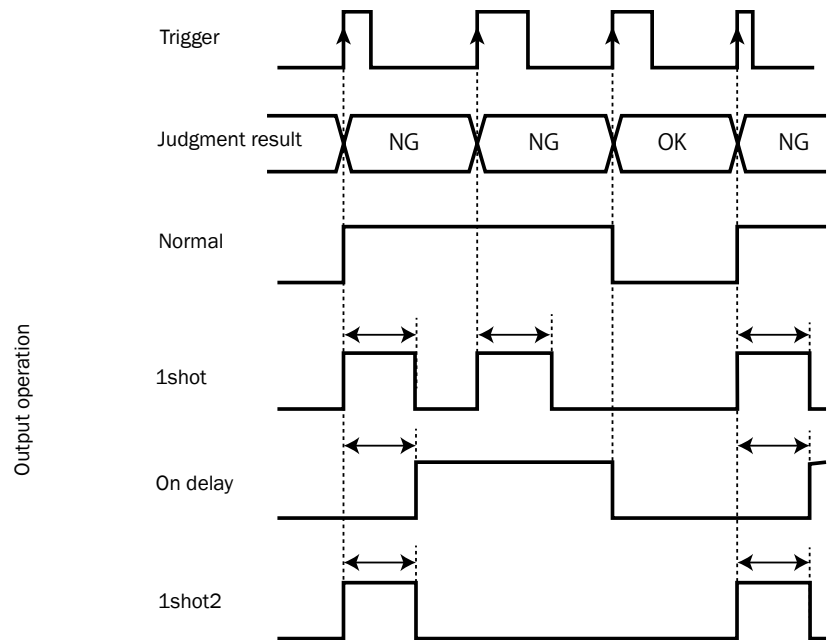

Reset and bank switching

The following timing chart shows the operations performed when changing the bank from the bank used when “Trig action” is set to “Cont” to the bank used when “Trig action” is set to “1shot.”
The operations of the strobe and ready outputs vary depending on the “Trig action” setting.

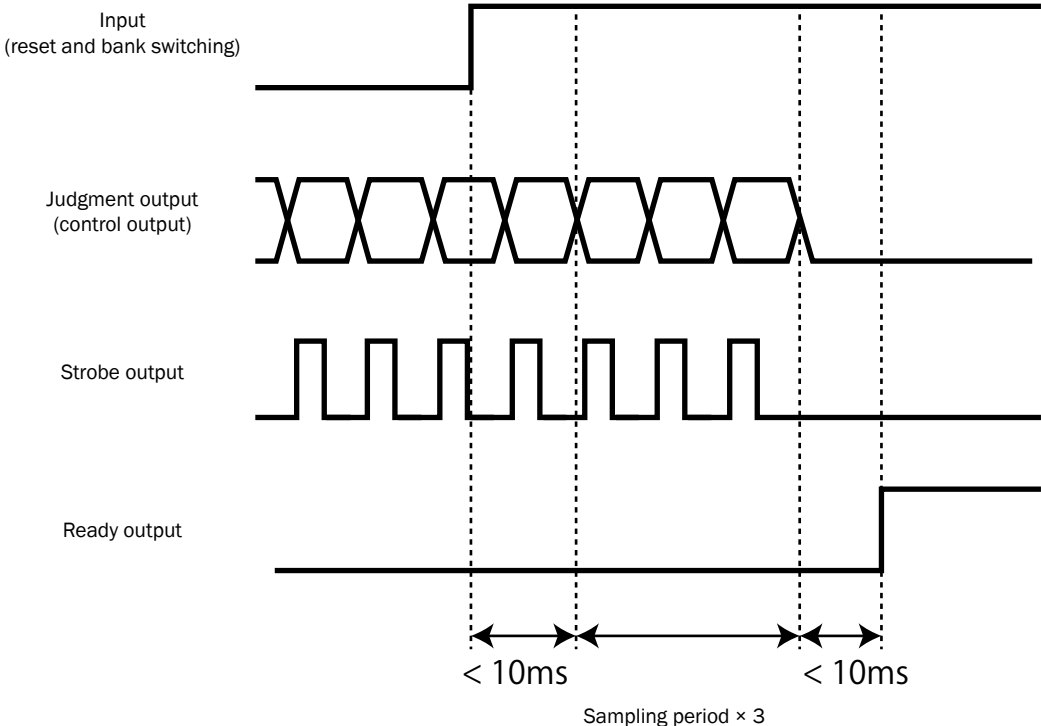

- Tips:
- It takes up to 10 ms from reset and bank input until response.
 - Output is indefinite while processing is in progress (sampling period x 3).

Australia

Phone +61 3 9457 0600
1800 334 802 – tollfree
E-Mail sales@sick.com.au

Austria

Phone +43 22 36 62 28 8-0
E-Mail office@sick.at

Belgium/Luxembourg

Phone +32 2 466 55 66
E-Mail info@sick.be

Brazil

Phone +55 11 3215-4900
E-Mail marketing@sick.com.br

Canada

Phone +1 905 771 14 44
E-Mail information@sick.com

Czech Republic

Phone +420 2 57 91 18 50
E-Mail sick@sick.cz

Chile

Phone +56 2 2274 7430
E-Mail info@schadler.com

China

Phone +86 20 2882 3600
E-Mail info.china@sick.net.cn

Denmark

Phone +45 45 82 64 00
E-Mail sick@sick.dk

Finland

Phone +358-9-2515 800
E-Mail sick@sick.fi

France

Phone +33 1 64 62 35 00
E-Mail info@sick.fr

Germany

Phone +49 211 5301-301
E-Mail info@sick.de

Hong Kong

Phone +852 2153 6300
E-Mail ghk@sick.com.hk

Hungary

Phone +36 1 371 2680
E-Mail office@sick.hu

India

Phone +91 22 6119 8900
E-Mail info@sick-india.com

Israel

Phone +972 4 6881000
E-Mail info@sick-sensors.com

Italy

Phone +39 02 274341
E-Mail info@sick.it

Japan

Phone +81 3 5309 2112
E-Mail support@sick.jp

Malaysia

Phone +6 03 8080 7425
E-Mail enquiry.my@sick.com

Mexico

Phone +52 (472) 748 9451
E-Mail mario.garcia@sick.com

Netherlands

Phone +31 30 2044 000
E-Mail info@sick.nl

New Zealand

Phone +64 9 415 0459
0800 222 278 – tollfree
E-Mail sales@sick.co.nz

Norway

Phone +47 67 81 50 00
E-Mail sick@sick.no

Poland

Phone +48 22 539 41 00
E-Mail info@sick.pl

Romania

Phone +40 356 171 120
E-Mail office@sick.ro

Russia

Phone +7 495 775 05 30
E-Mail info@sick.ru

Singapore

Phone +65 6744 3732
E-Mail sales.gsg@sick.com

Slovakia

Phone +421 482 901201
E-Mail mail@sick-sk.sk

Slovenia

Phone +386 591 788 49
E-Mail office@sick.si

South Africa

Phone +27 11 472 3733
E-Mail info@sickautomation.co.za

South Korea

Phone +82 2 786 6321
E-Mail info@sickkorea.net

Spain

Phone +34 93 480 31 00
E-Mail info@sick.es

Sweden

Phone +46 10 110 10 00
E-Mail info@sick.se

Switzerland

Phone +41 41 619 29 39
E-Mail contact@sick.ch

Taiwan

Phone +886 2 2375-6288
E-Mail sales@sick.com.tw

Thailand

Phone +66 2645 0009
E-Mail Ronnie.Lim@sick.com

Turkey

Phone +90 216 528 50 00
E-Mail info@sick.com.tr

United Arab Emirates

Phone +971 4 88 65 878
E-Mail info@sick.ae

United Kingdom

Phone +44 1727 831121
E-Mail info@sick.co.uk

USA

Phone +1 800 325 7425
E-Mail info@sick.com

Vietnam

Phone +84 945452999
E-Mail Ngo.Duy.Linh@sick.com