

Precision Pressure Indicator

CPG2500





Warning

This Warning symbol indicates that danger of injury for persons and the environment and/or considerable damage (mortal danger, danger of injury) will occur if the respective safety precautions are not taken.



Caution

This Caution symbol indicates danger for the system and material if the respective safety precautions are not taken.



Notice

This Notice symbol does not indicate safety notices but information for a better understanding of the facts.

Table of Contents

1. General Information	7
1.1 Warranty	7
1.2 Important Notice	7
1.3 FCC Radio Frequency Emission Notice	7
1.4 Trademarks and Copyrights	8
1.5 Software License Agreement	8
1.6 Mensor Service Plus	8
1.6.1 After the Warranty	8
1.6.2 Calibration Services	8
1.6.3 Certifications and Accreditations	8
1.7 Packaging for Shipment	8
2. Safety Notices	10
2.1 User Responsibilities	10
2.2 General Safety Notices	10
2.3 Warnings and Caution Notices	11
3. General Description	12
3.1 Features	12
3.2 Turning On	13
3.3 Front Panel	13
3.4 Display	14
3.5 Chassis Assembly	14
4. Specifications	15
4.1 Transducer Specification	15
4.1.1 Measurement & General Specifications	16
5. Installation	18
5.1 Unpacking the Instrument	18
5.2 Dimensions (inches)	19
5.3 Mounting	20
5.4 Rear Panel	20
5.4.1 Pressure Connections	21
5.4.2 Pressure Port	21
5.4.3 Reference Port	21
5.5 Remote Communication Connections	21
5.6 Power Up	21
5.7 Electrical Block Diagram	22
6. Local Operation and Setup	23
6.1 General Operation	23

6.1.1	Setup Applications	23
6.1.2	Display Screen Features	23
6.2	Initial Setup	24
6.2.1	Contact and Version Information Application	24
6.2.2	Language Selection	24
6.3	Application Selection and parameter inputs	25
6.4	Applications:	26
6.4.1	Measure Application	26
6.4.1.1	Pressure Mode / Emulation Mode	27
6.4.1.2	Auxiliary Displays	28
6.4.1.3	Zero Button	29
6.4.1.4	Tare Button	30
6.4.2	Settings Application	31
6.4.2.1	Languages	31
6.4.2.2	Brightness	32
6.4.2.3	Volume	32
6.4.2.4	User base units / Base units multiplier	33
6.4.2.5	Barometer Units	33
6.4.2.6	Configuration	34
6.4.3	Frames Application	35
6.4.3.1	Frame Format	35
6.4.3.2	Frames Channel	36
6.4.4	Transducer Application	37
6.4.4.1	Transducer Channel Selection	37
6.4.4.2	Transducer Delta Emulation	38
6.4.4.3	Transducer Filter	38
6.4.4.4	Transducer Resolution	39
6.4.4.5	Auxiliary Displays	40
6.4.4.6	Cal Function	41
6.4.5	Remote Application	42
6.4.5.1	Remote Command Set	42
6.4.5.2	Remote Communication Settings	43
6.4.6	Info Application	44
6.4.7	Leak Test Application	45
6.4.8	Troubleshooting Application	46
6.4.9	Logging Application	47
6.4.9.1	Remote Logging	47
6.4.9.2	Pressure Logging	48

6.4.10 Service Application	49
6.4.11 Unlocked Service Application	50
7. Remote Operation	52
7.1 Command Set	52
7.2 IEEE-488	52
7.2.1 IEEE-488.2 Commands	52
7.3 Ethernet	53
7.4 Serial	54
7.4.1 Serial Cable Requirements	54
7.5 Mensor Command Set	55
7.6 Command and Query Format	55
7.7 Command Set Definitions	55
7.8 Output Formats	56
7.9 CPG2500 Commands and Queries	56
7.9.1 Units Command Syntax for Measurement Units	64
7.9.2 CPG2500 Error Codes	65
7.9.3 SCPI Commands and Queries	65
7.9.4 SCPI Commands Error Messages and Error Codes	68
7.9.5 GPIB Capability Codes	68
7.9.6 Interface Functions	68
7.10 USB Software Upgrade	69
8. Options	71
8.1 Barometer	71
8.2 Barometric Reference (CPX-A-G1-3-J of CPX-A-G1-3-D)	71
8.2.1 Absolute Pressure Emulation	71
8.2.2 Emulation Mode Accuracy	72
8.2.3 Barometric Reference Calibration	72
8.2.4 Barometric Reference Specifications	72
8.3 Delta Channel	72
8.4 External Transducers (CPT9000, CPT6100 and CPT6180)	72
8.4.1 External Pressure Sensor Connection Cable	72
8.5 Analog Output	73
8.5.1 Specifications	73
8.6 Rack Mount Kit (CPX-A-G1-D of CPX-A-G1-R)	73
8.7 Fittings (CPX-A-G1-M, CPX-A-G1-C, CPX-A-G1-B, CPX-A-G1-I, CPX-A-G1-E, CPX-A-G1-N, CPX-A-G1-A, CPX-A-G1-S, CPX-A-G1-F)	73
8.8 Remote Calibration (CPX-A-G1-4 or CPX-A-G1-5)	73
8.8.1 Remote Calibration Kit for Internal Transducers.	74

8.8.2	Barometric Reference Calibration Sled	74
8.8.3	External Calibration Procedures	75
8.8.3.1	Transducer Removal	75
8.8.3.2	Barometric Reference Removal	75
9.	Maintenance	76
9.1	Beyond the Warranty	76
9.2	Spare Parts	76
10.	Calibration	77
10.1	Environment	77
10.2	Pressure Standards	77
10.3	Media	77
10.4	Setup	78
10.5	Service Application	79
10.5.1	Service Application (unlocked)	80
10.6	Calibration Data	81
10.7	One Point Cal Application	81
10.8	Two Point Cal Application	82
10.9	Linearization	83
10.10	Head Pressure	86
11.	Appendix	88
11.1	Conversion Factors, PSI	89
11.2	Conversion Factors, Millitorr	90
11.3	Conversion Factors, Pascal	91

1 General Information

1.1 Warranty

All products manufactured by Mensor are warranted to be free of defects in workmanship and materials for a period of two years from the date of shipment. No other express warranty is given, and no affirmation of Seller, by words or actions, shall constitute a warranty. SELLER DISCLAIMS ANY IMPLIED WARRANTIES OF MERCHANTABILITY OR FITNESS FOR ANY PARTICULAR PURPOSES WHATSOEVER. If any defect in workmanship or material should develop under conditions of normal use and service within the warranty period, repairs will be made at no charge to the original purchaser, upon delivery of the product(s) to the factory, shipping charges prepaid. If inspection by Mensor or its authorized representative reveals that the product was damaged by accident, alteration, misuse, abuse, faulty installation or other causes beyond the control of Mensor, this warranty does not apply. The judgment of Mensor will be final as to all matters concerning condition of the product, the cause and nature of a defect, and the necessity or manner of repair. Service, repairs or disassembly of the product in any manner, performed without specific factory permission, voids this warranty.

MENSOR MAKES NO WARRANTY OF ANY KIND WITH REGARD TO THIS MANUAL, INCLUDING, BUT NOT LIMITED TO, THE IMPLIED WARRANTIES OF MERCHANTABILITY AND FITNESS FOR A PARTICULAR PURPOSE. Mensor shall not be liable for errors contained herein or for incidental or consequential damages in connection with the furnishing, performance, or use of this material.

1.2 Important Notice

The product specifications and other information contained in this manual are subject to change without notice.

Mensor has made a concerted effort to provide complete and current information for the proper use of the equipment. If there are questions regarding this manual or the proper use of the equipment, contact Mensor at:

Mensor
201 Barnes Drive
San Marcos, Tx 78666
Tel: 1.512.396.4200
1.800.984.4200 (USA only)
web site: www.mensor.com
fax: 512.396.1820
e-mail: sales@mensor.com
tech.support@mensor.com

WIKA Alexander Wiegand SE & Co. KG
Alexander-Wiegand-Straße 30
D-63911 Klingenberg / Germany
Tel: (+49) 93 72/132-9986
web site: www.wika.de
fax: (+49) 93 72/132-8767
e-mail: testequip@wika.de

1.3 FCC Radio Frequency Emission Notice

This equipment has been tested and found to comply with the limits for a Class A digital device, pursuant to part 15 of the FCC Rules. These limits are designed to provide reasonable protection against harmful interference when the equipment is operated in a commercial environment. This equipment generates, uses, and can radiate radio frequency energy and, if not installed and used in accordance with the instruction manual, may cause harmful interference to radio communications. Operation of this equipment in a residential area is likely to cause harmful interference in which case the user will be required to correct the interference at his or her own expense.

USE SHIELDED CABLES TO CONNECT EXTERNAL DEVICES TO THIS INSTRUMENT TO MINIMIZE RF RADIATION.

1.4 Trademarks and Copyrights

Mensor is a registered trademark of Mensor, LP. All other brand and product names are trademarks or registered trademarks of their respective companies. ©2007, Mensor, LP. All rights reserved.

1.5 Software License Agreement

This product contains intellectual property, i.e., software programs, that are licensed for use by the end user/customer (hereinafter “end user”).

This is not a sale of such intellectual property.

The end user shall not copy, disassemble or reverse compile the software program.



Notice

The software programs are provided to the end user “as is” without warranty of any kind, either express or implied, including, but not limited to, warranties of merchantability and fitness for a particular purpose. The entire risk of the quality and performance of the software program is with the end user.

Mensor and its suppliers shall not be held to any liability for any damages suffered or incurred by the end user (including, but not limited to, general, special, consequential or incidental damages including damages for loss of business profits, business interruption, loss of business information and the like), arising from or in connection with the delivery, use or performance of the software program.

1.6 Mensor Service Plus

If you have problems and you don't find the answer in this manual, contact Mensor at 1.800.984.4200 (USA only) or 1.512.396.4200 for personal assistance, or at any of the contact addresses listed on the rear cover of this manual. We are ready to help.

1.6.1 After the Warranty

Mensor's concern with the performance of this instrument is not limited to the warranty period. We provide complete repair, calibration and certification services after the warranty for a nominal fee.

1.6.2 Calibration Services

In addition to servicing our own products Mensor can perform a complete pressure calibration service, up to 30,000 psi, for all of your pressure instruments. This service includes an accredited calibration.

1.6.3 Certifications and Accreditations

Mensor is registered to ISO 9001:2015. The calibration program at Mensor is accredited by A2LA, as complying with both the ISO/IEC 17025:2017 and the ANSI/NCSL Z540-1-1994 standards.

1.7 Packaging for Shipment

If the product must be shipped to a different location or returned to Mensor for any reason through a common carrier it must be packaged properly to minimize the risk of damage.

The recommended method of packing is to place the instrument in a container, surrounded on all sides with at least four inches of shock attenuation material such as styrofoam peanuts.

Strictly observe the following when shipping the instrument:

All instruments delivered to WIKA or Mensor must be free from any kind of hazardous substances (acids, bases, solutions, etc.) and must be cleaned before being returned.



WARNING!

Physical injuries and damage to property and the environment through residual media

Residual media in the dismantled instrument can result in a risk to persons, the environment and equipment.

- ▶ With hazardous substances, include the material safety data sheet for the corresponding medium.

When returning the instrument, use the original packaging or a suitable transport packaging.

To avoid damage:

- Wrap the instrument in an anti-static plastic film.
- Place the instrument along with shock-absorbent material in the packaging.
- Place shock-absorbent material evenly on all sides of the transport packaging.
- If possible, place a bag containing a desiccant inside the packaging.
- Label the shipment as a highly sensitive measuring instrument.

Instruments with lithium ion rechargeable batteries or lithium metal batteries

The included lithium ion rechargeable batteries or lithium metal batteries are subject to the requirements of the dangerous Goods Act. For shipping, special packaging and labelling requirements must be observed. A dangerous goods expert must be consulted when preparing the item to be shipped. Do not send any damaged or defective rechargeable batteries. Cover open contacts with adhesive tape and package the rechargeable battery such that it cannot move inside the package and short circuits are prevented. The different requirements of the relevant transport carriers as regard to the Dangerous Goods Act and also additional national regulations must be observed.



Information on returns can be found under the heading "Service" on our local website.

2 Safety Notices

2.1 User Responsibilities

To ensure safety, the user must make sure that:

- The system is used properly, no dangerous media are used and that all technical specifications are observed.
- The system is operated in perfect operating condition.
- This operation manual is legible and accessible to the user at the system's location.
- The system is operated, serviced and repaired only by authorized and qualified personnel.
- The operator receives instruction on industrial safety and environmental protection, and is knowledgeable of the operating instructions and the safety notices contained therein.

2.2 General Safety Notices



Notice

The system should only be operated by trained personnel who are familiar with this manual and the operation of the instrument.



Warning

WARNING: A condition for trouble-free and safe operation of this system is proper transport, proper storage, installation, assembly and proper use as well as careful operation and maintenance.

Any operation not described in the following instructions should be prohibited. The system must be handled with care required for an electronic precision instrument (protect from humidity, impacts, strong magnetic fields, static electricity and extreme temperatures). Do not insert any objects into the instrument.

The system is powered via the power cable with a voltage that can cause physical injury. Even after disconnecting the system from the power supply, dangerous voltages can temporarily occur due to capacitance.

Extreme care must be taken with pressure connections when using hazardous or toxic media.

Repairs must only be performed by authorized service personnel.



Notice

Additional safety notices are found throughout this manual.

2.3 Warnings and Caution Notices



Warning

WARNING: HIGH PRESSURE! High pressure gases are potentially hazardous. Energy stored in these gases and liquids can be released suddenly and with extreme force. High pressure systems should be assembled and operated only by personnel who have been trained in proper safety practices.



Warning

WARNING: NOT EXPLOSION PROOF! Installation of this instrument in an area requiring devices rated as intrinsically safe is not recommended.



Warning

WARNING: POSSIBLE INJURY! The tubing, valves, and other apparatus attached to the gauge must be adequate for the maximum pressure which will be applied, otherwise physical injury to the operator or bystanders is possible.



Caution

CAUTION: USE THE PROPER PRESSURE MEDIUM! Use only clean, dry, non-corrosive gases unless otherwise specified by Mensor. This instrument is not designed for oxygen use.



Caution

CAUTION: As with most sensitive electronic equipment, switch the power switch off before connecting or disconnecting to a power source to prevent data loss. Do not position the equipment so that it is difficult to disconnect the DC power jack.



CAUTION: ESD PROTECTION REQUIRED. The proper use of grounded work surfaces and personal wrist straps are required when coming into contact with exposed circuits (printed circuit boards) to prevent static discharge to sensitive electronic components.

Additional Warning and Caution notices are found throughout this manual.

Precision Pressure Indicator CPG2500

3 General Description

The CPG2500 Precision Pressure Indicator is a multi-channel pressure indicator designed to test and calibrate a variety of pressure devices in either absolute or gauge pressure modes. The CPG2500 can have two independent internal transducers, an optional barometric reference and an external remote pressure transducer.



Figure 3.1 - Desk top version

3.1 Features

Here is a short list of significant features designed into the CPG2500:

- Up to two removable / interchangeable, highly stable, temperature compensated, internal pressure transducers. (Option to connect two external transducers via a rear mounted RS-232 port in place of the two internal transducers)
- An optional remote transducer in addition to the two internal transducers.
- An optional removable / interchangeable internal high accuracy barometric reference transducer providing gauge pressure emulation for absolute ranges and absolute pressure emulation for gauge ranges.
- Optional Analog output for each internal sensor.
- 7" Color LCD with touch screen
- Delta function when two or more transducers are installed
- Multiple languages; change the language for on-screen text and number/date formats by simply touching one of the "national flag" icons available in the setup screen.
- Desk top or rack mount
- Local Operation, or command and read remotely.

3.2 Turning On

You can confirm that your CPG2500 is operational right now. Apply power to the power connector on the rear of the instrument with the included power adapter, remove any plastic plugs from the rear panel pressure ports, and press the power switch to ON. The system will go through an initialization process, which takes about 45 seconds, and then a display will appear similar to the screen shown below.



To see information about the configuration of your new CPG2500, touch the Information Application (App) icon on the menu and a window will appear listing the Mensor customer service contact, model number and the sensors that are installed. Press the Measure App [] to return to the main screen.

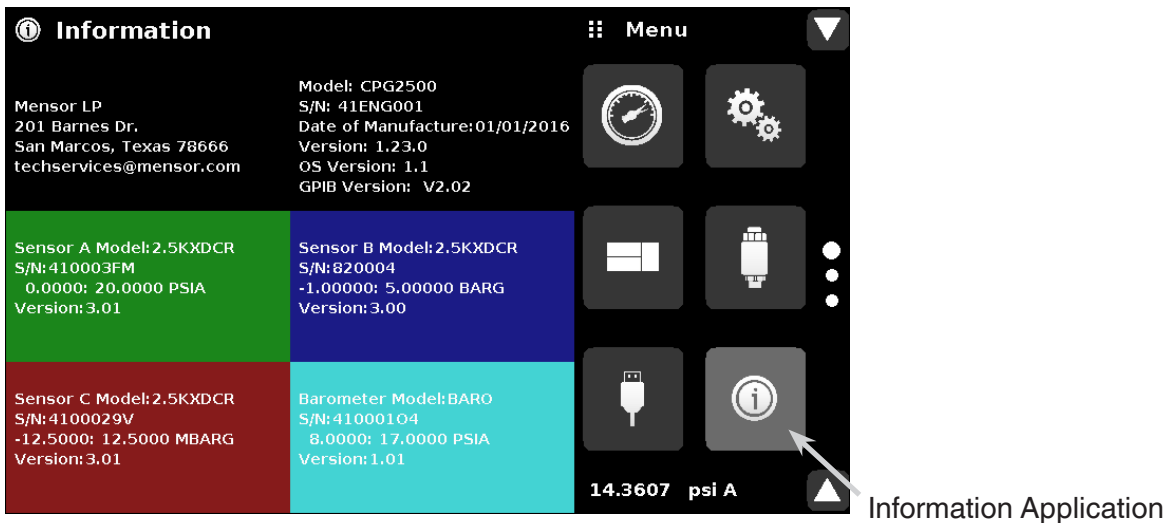

3.3 Front Panel

The CPG2500 front panel includes a 7" color LCD with touch screen. Operator input is accomplished by pressing the words or App icons presented on the display. There is a single discrete on/off button and a USB on the right hand side. The front panel also shows the model number designation and brand logos.

Precision Pressure Indicator CPG2500

3.4 Display

The display is made up of two sections. In the main screen (“Measure Application”), the left two thirds shows the transducer channels that are configured for display, along with the pressure reading, units, mode (absolute or gauge), channel label, an auto zero or tare button (if enabled) and any auxiliary indications that have been chosen. The right one third of the screen has Application Icons (“Apps”) for setting viewing options, sensor settings, communication settings plus a “Page Down” button [▼] that, when pressed, shows a second and third page of icons for calibration, remote communication error checking and a leak test application.

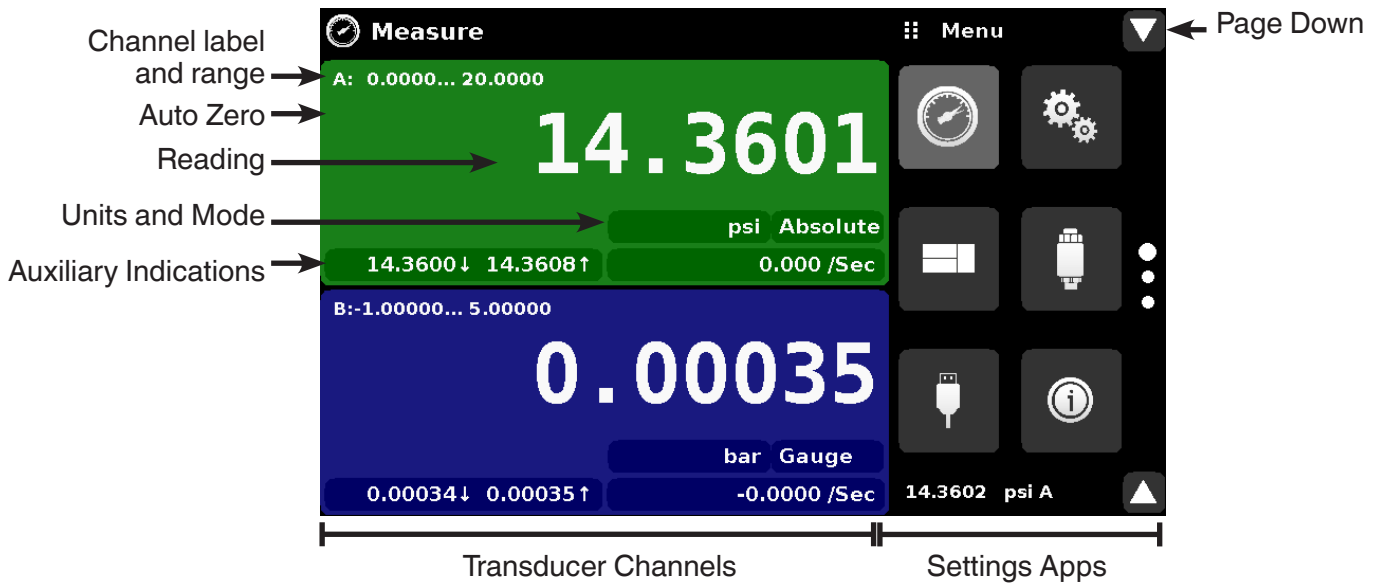

Buttons, Labels and Windows: The CPG2500 touch screen has many buttons with relevant graphic icons or text which, when pressed, will open a related window where changes can be made or information viewed. Some of these buttons will toggle from one state to another, others present choices or display a numerical data entry screen. Text or icons that are displayed, but do not respond to being touched, are called labels or windows. Operators will quickly become accustomed to the particular characteristics of the frequently used buttons.

Main Screen: The main screen or “Measure Application”, appears after power-up. This screen contains the channel frames and settings button. It will remain as configured after a power cycle.

Transducer Channel Frame(s): The transducer channel frames (left 2/3 of the screen) contain information specific to a channel. Up to three channels can be displayed at once, two are shown in the picture above. The channel frames are color coded with channel A - green, channel B - blue and the remote channel - red. The optional barometer channel is sky-blue and the delta channel is yellow. If only one channel is installed, a full frame will be displayed in the color of the channel connected. The channel frame contains the pressure reading, units, and mode(absolute or gauge) plus any auxiliary displays that have been chosen.

3.5 Chassis Assembly

The chassis assembly is the housing for the system and the removable transducers. The system has no user-serviceable parts, and therefore the chassis should not be opened except by qualified repair personnel at Mensor or certified service locations for any reason except to change the removable transducers.

4 Specifications

Accuracy specifications presented herein are obtained by comparison with primary standards traceable to a national metrology institute or recognized international standard organization. These specifications are obtained in accordance with the ISO Guide to the Expression of Uncertainty in Measurement (GUM). The calibration program at Mensor is accredited by the American Association of Laboratory Accreditation (A2LA) as complying with both the ISO/IEC 17025:2017 and the ANSI/NCSL Z540-1-1994 standards. If there is an exception to the requirements and recommendations of Z540 during a calibration the exception is noted on the individual calibration certificate.

Mensor reserves the right to change specifications without notice.

4.1 Transducer Specification

Standard Reference Transducers, Model CPR2550			
Accuracy ⁽¹⁾	0.01%FS ⁽³⁾	0.01%IS-50 ⁽²⁾	0.008%IS-33 ⁽⁶⁾
Bi-Directional Pressure	-0.18...0.18 to -14.5...10,000 psi ⁴⁾ -12.5...12.5 mbar to -1...700 bar	-14.5 ... 145 up to 6,000 psi ⁴⁾ -1...10 up to 400 bar	-14.5...145 psi up to 1,500 psi -1...10 bar up to 100 bar
Absolute Pressure ⁽⁴⁾⁽⁵⁾	0...7.5 up to 10,015 psi 0...0.5 up to 701 bar	0...14.5 up to 6,015 psi 0...1 up to 401 bar	0...14.5 up to 1,515 psi 0...1 up to 101 bar
Precision ⁽⁶⁾	0.004%FS	0.004%FS	0.004% FS
Calibration Interval	365 days ⁽⁷⁾	365 days	365 Days
Media Compatibility			
Wetted parts	6000/7000 series Aluminum, 316 SS, brass, PTFE (Teflon®), Urethane, Silicone, RTV, Silicone grease, PVC, Epoxy, Buna-N, fluoroelastomers (Viton®)		
Pressure media	Ranges ≤ 15 psi – Pneumatic media only Ranges > 15 psi – Pneumatic and non-corrosive hydraulic media allowed		
Sensor			
Reading rate	33 readings/second		
Calibration adjustments	Internal zero adder and span multiplier, up to 11 point linearization for each sensor		

Precision Pressure Indicator CPG2500

Premium Reference Transducers, Model CPR2580

Accuracy ⁽¹⁾	0.008% IS-50 ⁽⁹⁾	0.01% FS ⁽³⁾	0.014% FS ⁽³⁾
Absolute Pressure ⁽⁴⁾	0...1,500 to 0...3,300 psia 0...4,200 to 0...6,600 psia	0...8,000 to 0...11,000 psia	0...12,000 to 0...22,000 psia 0...24,000 to 0...31,500 psia 0...32,000 to 0...42,000 psia
Precision ⁽⁶⁾	0.004%FS	0.004%FS	0.004%FS
Calibration Interval ⁽⁷⁾	365 days	365 days	365 days
Media Compatibility			
Wetted parts	6000/7000 series Aluminum, 316 SS, brass, PTFE (Teflon®), Urethane, Silicone, RTV, Silicone grease, PVC, Epoxy, Buna-N, fluoroelastomers (Viton®)		
Pressure media	Hydraulic media only available > 6,015 psia		
Sensor			
Reading rate	10 readings/second		
Calibration adjustment	Internal Zero adder and Span multiplier, up to 11 point linearization for each sensor		

- ⁽¹⁾ It is defined by the total measurement uncertainty, with the coverage factor (k = 2) and includes the intrinsic performance of the instrument, the measurement uncertainty of the reference instrument, long-term stability, influence of ambient conditions, drift and temperature effects over the compensated range with recommended zero point adjustment every 30 days.
- ⁽²⁾ 0.01 % IS-50 accuracy: Between 0 ... 50 % of the full scale, the accuracy is 0.01% of half of the full scale value and between 50 ... 100 % of the full scale, the accuracy is 0.01 % of reading.
- ⁽³⁾ FS = full span.
- ⁽⁴⁾ Ranges from 1500 to 2000 psig will be sealed gauge transducers.
- ⁽⁵⁾ The minimum calibrated range of absolute transducer(s) is 600 mTorr.
- ⁽⁶⁾ It is defined as the combined effects of linearity, repeatability and hysteresis throughout the stated compensated temperature range.
- ⁽⁷⁾ 180 days for pressure ranges (absolute and gauge) below 1 bar (15 psi) and -1...1 bar (-15...14.5 psi) bidirectional. 365 days for the remainder of specified ranges.
- ⁽⁸⁾ 0.008 % IS-33 accuracy: Between 0 ... 33 % of the full scale, the accuracy is 0.008% of one third of the full scale value and between 33 ... 100 % of the full scale, the accuracy is 0.008 % of reading.
- ⁽⁹⁾ 0.008 % IS-50 accuracy: Between 0 ... 50 % of the full scale, the accuracy is 0.008% of half of the full scale value and between 50 ... 100 % of the full scale, the accuracy is 0.008 % of reading.

4.1.1 Measurement & General Specifications

Basic Instrument

Instrument

Instrument version	Standard: Table top with tilt feet Option: -19" rack-mounting for single instrument mount. -19" rack-mounting for dual instrument mount.
--------------------	---

Dimensions	See technical drawing
------------	-----------------------

Weight	12.5 lbs./ 5.7 kg (with all internal options)
--------	---

Warm-up time	Approximately 15 minutes
--------------	--------------------------

Display

Screen	7" color LCD
--------	--------------

Resolution	Selectable from 4 to 7 digits, depending on range and units
------------	---

Data entry	Touch screen keypad
------------	---------------------

Measurement Units	psi, psf, osi, atm, inH2O@4C, inH2O@20C, inH2O@60F, mbar, bar, Dy/cm2, pascal, hPa, kPa, MPa, inHg@0C, inHg@60F, mTorr, Torr, mmHg@0C, cmHg@0C, mHg@0C, mmH2O@4C, cmH2O@4C, mH2O@4C, mmH2O@20C, cmH2O@20C, mH2O@20C, mSW, ftH2O@4C, ftH2O@20C, ftH2O@60F, inSW, ftSW, tsi, tsf, g/cm ² , kg/cm ² , kg/m ² , % of Range, + plus 2 user defined units (multiplier from psi, bar or pascal)
-------------------	---

Rate Units	/sec., /min., /hr., /3-hr
------------	---------------------------

Languages	English, German, Spanish, French, Italian, Portuguese, Polish, Russian, Chinese, Japanese, Korean
-----------	---

Measurement filters	Off, Low, Normal (default), High
---------------------	----------------------------------

Connections

Number of integrated transducer (selectable)	Standard: 1 reference transducer Optional: 2nd reference transducers, external transducer, internal barometric reference
Pressure connections	To 6015 psi: Up to 4 ports 7/16 - 20 female SAE. 1 10-32 UNF female port. Ranges >6015 psi: Up to 2 Autoclave F250C/HIP HF4
Pressure adaptors	Standard: None Optional: For up to 6015 psi, 1/4 inch tube fittings, 6 mm tube fittings, 1/4 in. female NPT fittings, 1/8 in. female NPT fittings or 1/8 in. female BSP fittings.
Overpressure limits	110 % FS typical, optional external relief valves are available

Voltage supply

Power input requirements	100-120 or 200-240 VAC, 50-60Hz, 24VA max
Switching power supply	Output: 12 VDC, 1.7 A (includes 4 region specific plugs adapters)

Permissible ambient conditions

Storage temperature range	0 to 70 deg C
Operating environment	0 ... 95 % RH (relative humidity, non-condensing)
Operating temperature range	15 ... 45 deg C
Operating Altitude	<3048 meters (10,000 ft)

Communications

Remote interface	IEEE 488, RS-232, USB and Ethernet
Command sets	Mensor, WIKA SCPI

CE conformity and certificates

CE compliance	EN61326-1:2013 electromagnetic compliance EN61010-1:2010 safety/CB scheme
RoHS directive	2011/65/EU, article 4
Calibration	Calibration certificate per ISO/IEC 17025:2017. Accreditation is by the American Association for Laboratory Accreditation (A2LA).

5 Installation

5.1 Unpacking the Instrument

In addition to functional testing, each unit is inspected for appearance prior to leaving the factory. Upon receipt, please examine the instrument for shipping damage. Report any apparent damage to the carrier immediately.

In addition to this manual you should have:

- CPG2500 Precision Pressure Indicator;
- Power Supply;
- Fitting adapters ordered;
- Any accessories ordered;
- An envelope containing the calibration certificate.

5.2 Dimensions (inches)

Desk top case

Front view

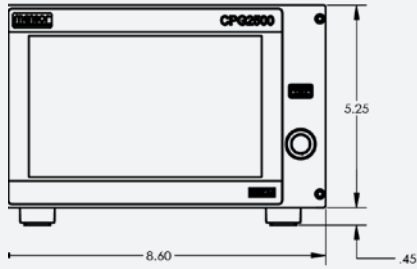

Side view

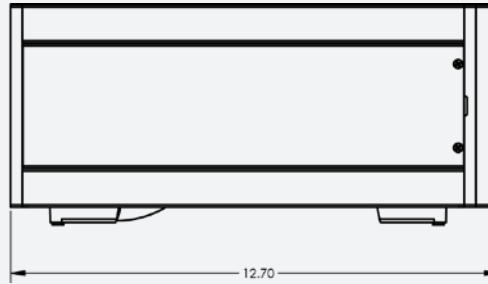

19" rack mount

Single mount - Front view

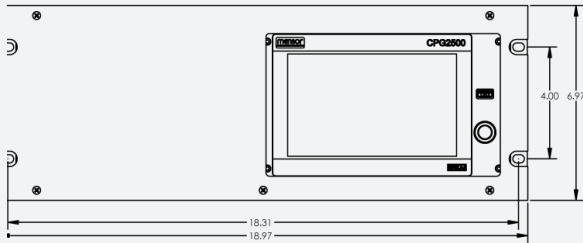

Dual mount - Front view

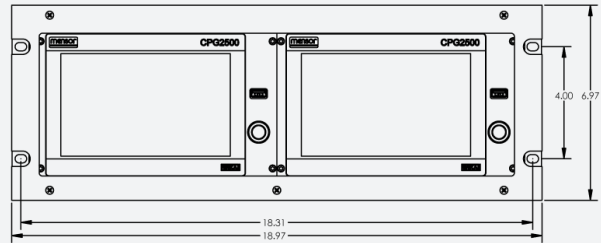

Rear Panel

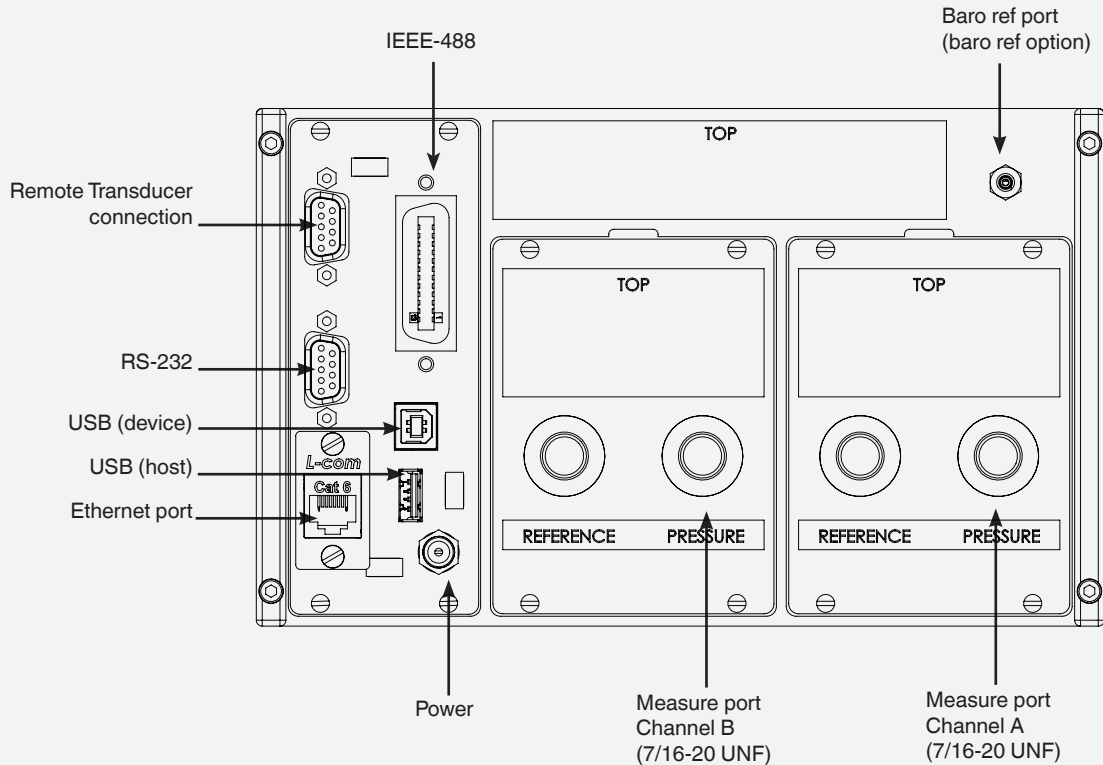

Precision Pressure Indicator CPG2500

5.3 Mounting

The instrument can be set up on a desk top or it can be rack-mounted. Rack mount hardware is optional on the CPG2500 (see Section 5.2 Dimensions and Section 8, Options).

The special sensors used in the CPG2500 are relatively insensitive to tilt and vibration. However to further assure stability and accuracy, avoid mounting the instrument on surfaces subject to excessive motor or machinery vibration.

5.4 Rear Panel

Two slots are available on the rear of the CPG2500. These slots can be filled with a removable transducer or a remote transducer interface connection. Gauge Transducers will have a reference and a pressure port. Absolute transducers will have a plug in the reference port. In the upper right corner is a hose barb fitting which is connected to the baro ref if installed. Transducers with analog output will have an electrical connection. Positioned on the left side is a remote transducer connection, the RS-232, Ethernet, IEEE-488, USB device connections for communication, the USB host connection and the 12 VDC power input.

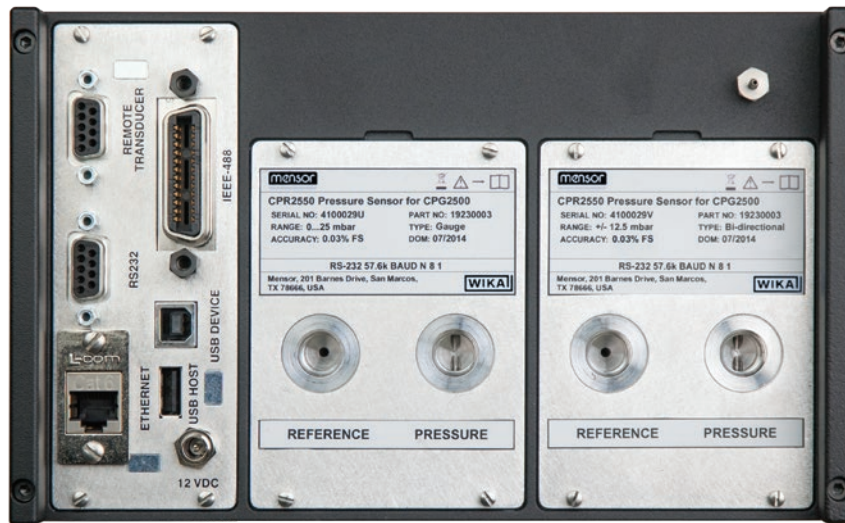

Figure 5.4 A - Two removable gauge transducers installed



Figure 5.4 B - Two remote transducer interface connections installed

5.4.1 Pressure Connections



Notice

When making up a connection to an o-ring adapter fitting port use a back-up wrench to prevent over-stressing the threads in the manifold block.

For pressure range less than 6015 psi, the pressure ports on the rear are female 7/16 - 20 SAE/MS straight threads per MS16142 and SAE J514 table 14. Connected adaptors require a tube fitting boss seal with an o-ring per MS33656. Mensor can provide a variety of adapter fittings (see Section 8 Options) with the instrument. Do not use sealant on fittings sealed with an o-ring. The integrity of each seal is particularly important since even microscopic leaks can cause errors in pressure measurements. For a pressure range greater than 6015 psi, a fixed Autoclave F250C/HIP HF4 fitting is attached.

5.4.2 Pressure Port

The CPG2500 will precisely measure the pressure connected to the pressure port up to the full scale range of the transducer installed.

5.4.3 Reference Port

The reference port is available on gauge units that have sensors that are not sealed gauge units. For these units this port is available to connect to the reference side of the sensor. This port is normally left open to atmosphere but may be connected to a stable reference pressure. In an absolute pressure transducer this port is plugged.

5.5 Remote Communication Connections

See Section 7, Remote Operation, for connections and commands for operation over IEEE-488, Ethernet, USB or RS-232 ports.

5.6 Power Up

Apply power to the power connector on the rear of the instrument using the power adaptor included, and switch the power switch on the front of the unit ON. The instrument will go through an initialization process and system check. As soon as the system check is completed the system will default to a screen similar to the one shown in Section 6.1.2 - Display Screen Features. The main measurement screen may be configured in many different ways but initially it will be in a default configuration. Subsequently, the unit will power up in the configuration that it was in when last powered off. Allow at least 15 minutes of warm up before performing critical pressure measurements.

5.7 Electrical Block Diagram

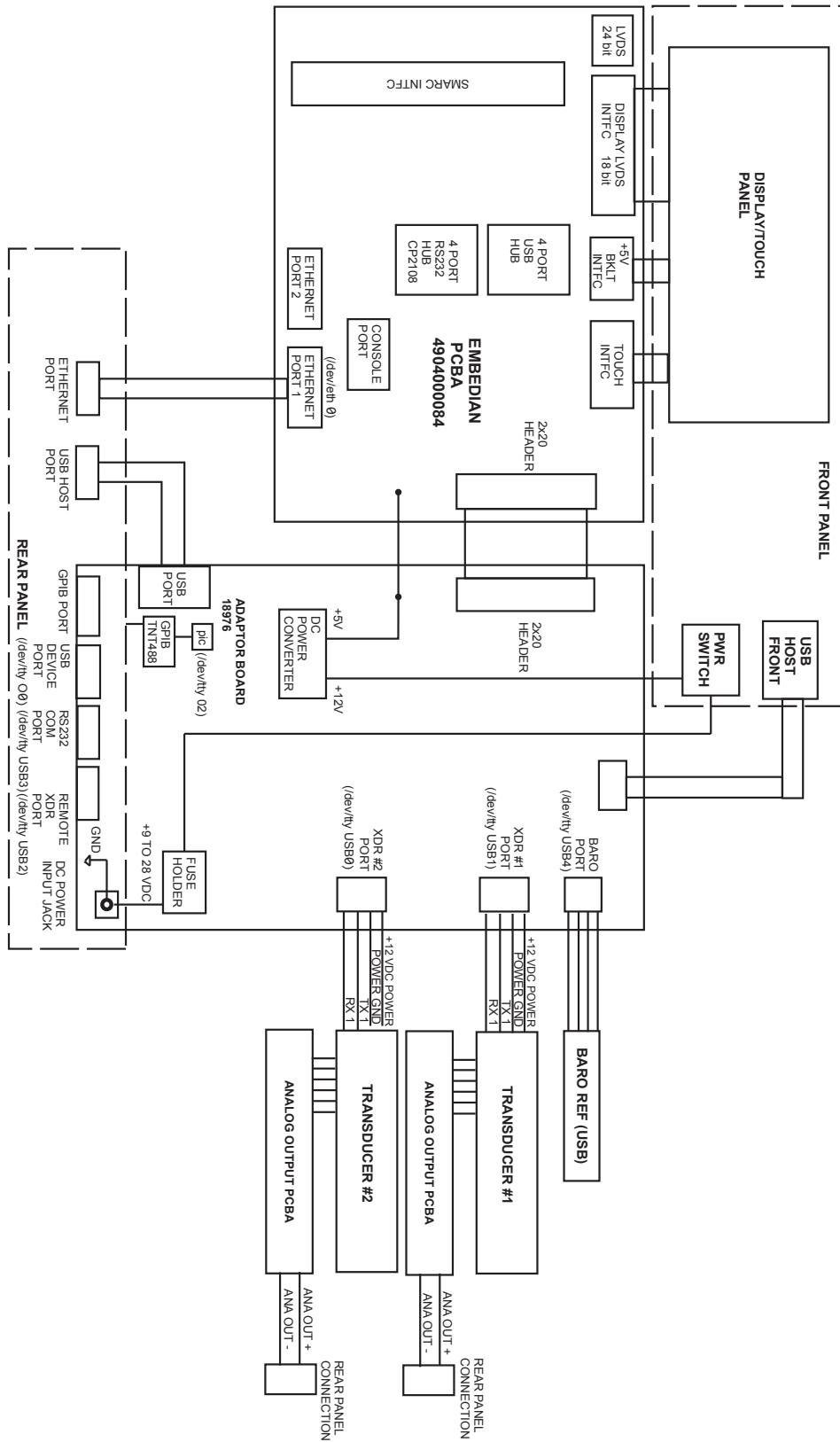

Figure 5.7 - Electrical Block Diagram

6 Local Operation and Setup

6.1 General Operation

This section describes the procedures for operating the CPG2500 from the front panel. Instructions for operating the device remotely from an external computer are covered in Section 7, Remote Operation. By following the procedures provided in these two sections and Section 10, Calibration, you can expect your CPG2500 to deliver maximum accuracy and dependability for many years of useful service.

6.1.1 Setup Applications

Configuration of the CPG2500 is achieved by changing settings accessed through the Application (“App”) buttons. Local operation is accomplished by observing the data presented in the display. The appearance and functionality of the display can be changed by pressing the App button for the related function. After an app has been chosen, a set of related parameters will appear on the left. After choosing one of these parameters, a set of selections related to that parameter will appear on the right or a data entry keypad. The desired selection or data can be entered here.

6.1.2 Display Screen Features

The screen shown below provides a brief description of the features shown on a 2 channel display after initialization. The left two thirds of the display contains the area where information is displayed (in this case the Measure Application) and the right one third contains the selection icons for each application. Channels are color coded: Channel A is green, B is blue, C (remote) is red and the barometer is sky-blue. Color coding persists throughout all channel-specific screens. A zero or tare button and auxiliary displays (auxiliary units, rate and peak) will appear in the Measure App if activated. All of the CPG2500 screen features are described in more detail throughout this manual.

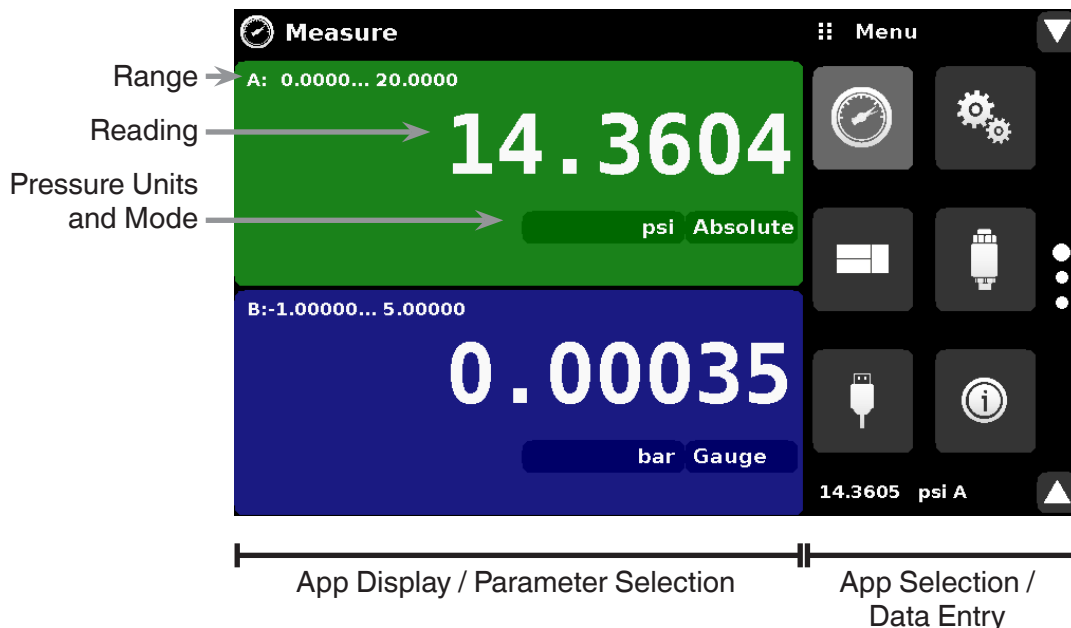

Figure 6.1.2 - Display Screen Features

Precision Pressure Indicator CPG2500

6.2 Initial Setup

Section 6.2.1 and 6.2.2 are provided first so that the operator can initially check the information screen to verify the installed components and to change the language if needed.

6.2.1 Contact and Version Information Application



Press this application button to display Mensor contact, installed sensor, instrument and software version information.

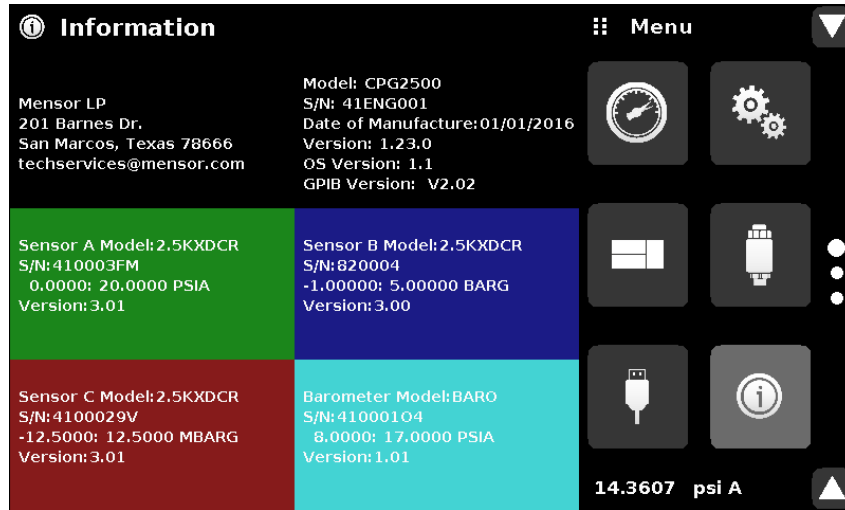

Figure 6.2.1 - Information

6.2.2 Language Selection





Pressing the settings application button will open a screen where the language, display brightness, volume, user base units/multiplier and configuration loading/saving, can be changed. The current language selections available are shown in the table below. Additional language choices will appear on the screen after pushing the Page Down button []:

Language	Country
English	USA
German	Germany
French	France
Spanish	Spain
Italian	Italy
Chinese	China
English	Great Britain
German	Switzerland
French	Switzerland
Spanish	Mexico
Russian	Russia
Korean	Korea
English	Canada
French	Canada
Polish	Poland
Japanese	Japan



6.3 Application Selection and parameter inputs

The application selection area on the right one third of the screen (see Figure 6.1.2 - Display Screen Features) is the area where setup, information and calibration Apps can be chosen. A second and third page of application selections can be accessed by pressing the page down button []. A series of vertically placed circles on the center right indicates the active page by a larger circle. As each App is chosen, related application parameters will appear on the left two thirds of the screen along with the name of the application, and a reduced size icon in the top title section. When a parameter is chosen, related selections, sliding scales or a data entry key pad will appear in the input area on the right where the application selection buttons were previously displayed. An example of each type of input is shown below. To return to the App selection menu, simply press the menu button [] above the input area. The purpose and use of each selection and menu is intuitively apparent and will become second nature with minimal exposure to the menu structure.

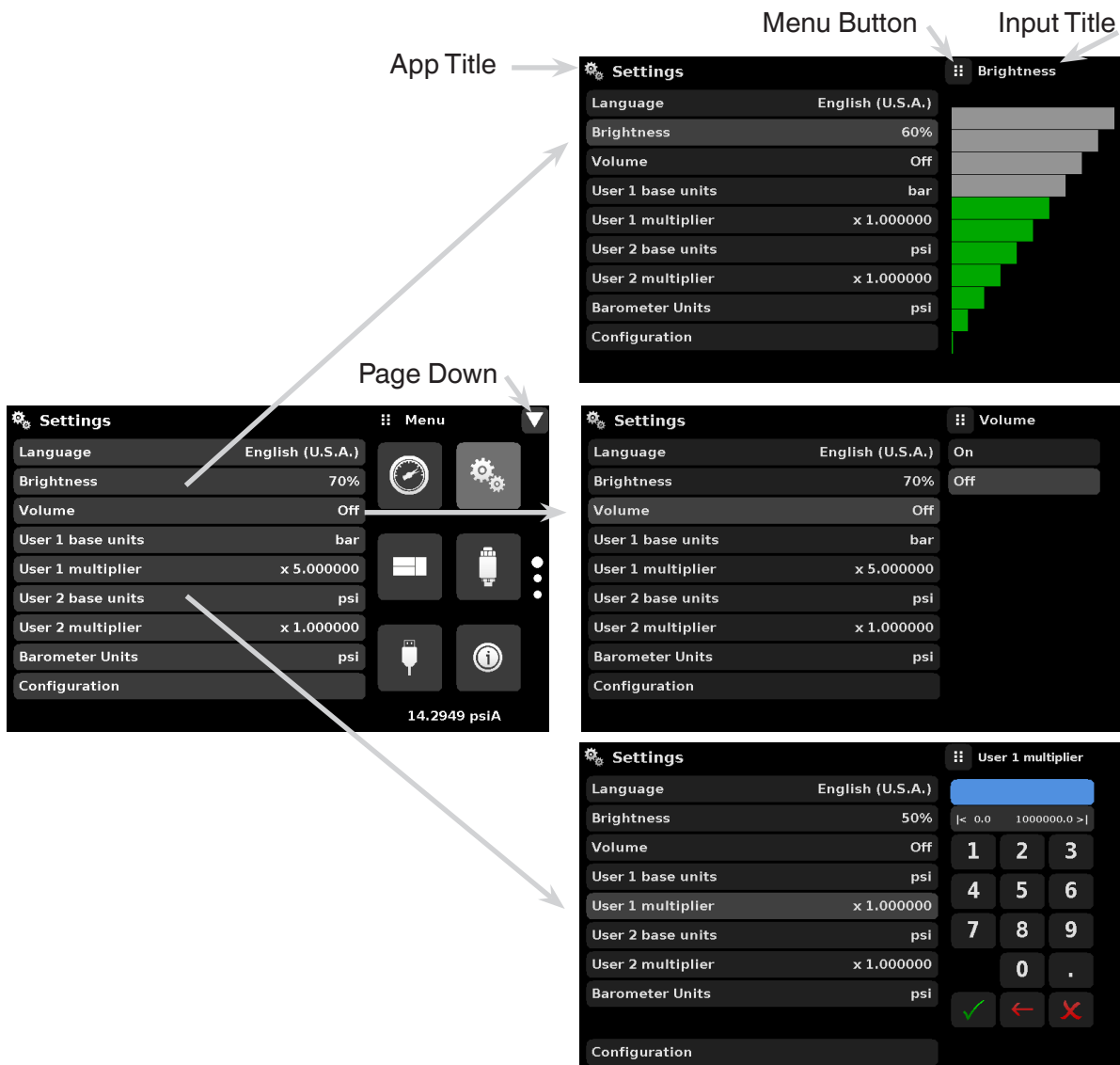

Precision Pressure Indicator CPG2500

6.4 Applications:

6.4.1 Measure Application



The Measure App is the normal operation screen referred to in previous instruments as the 'main screen'. This application is different from the others in that it is not used to setup the configuration but is used to monitor the pressure applied to the installed transducers.

The screen in figure 6.4.1-A shows the basic Measure App in a three channel instrument. The units button is always present in each channel. When the units button is pressed a selection of imperial and metric units will be displayed on the right (figure 6.4.1-B); notice that the Units button has a lighter background when the selection menu is active. Any unit of measure can be selected for any channel. If a barometric reference is installed, the Mode button, described below, will toggle from Gauge to Absolute mode when pressed.

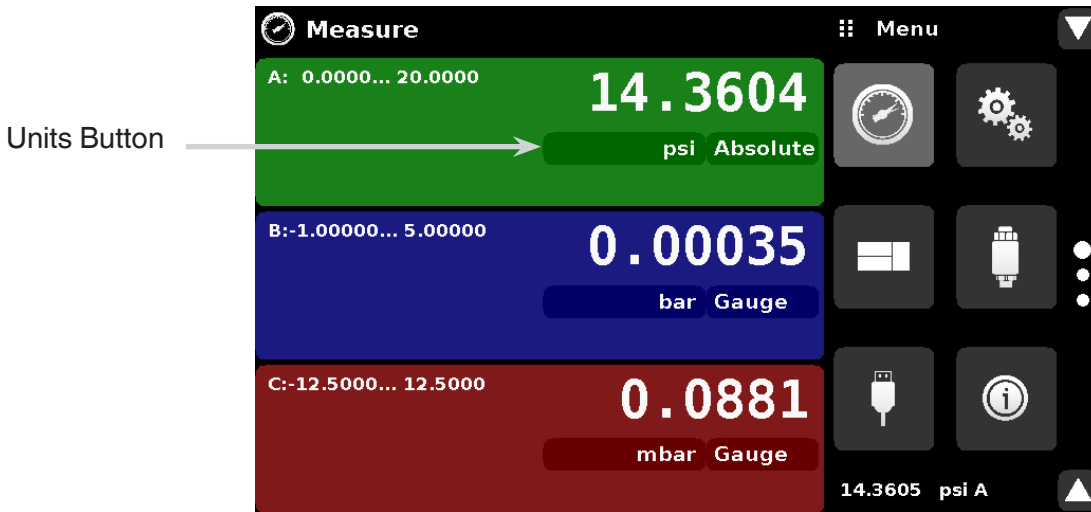

Figure 6.4.1-A Basic Measure App

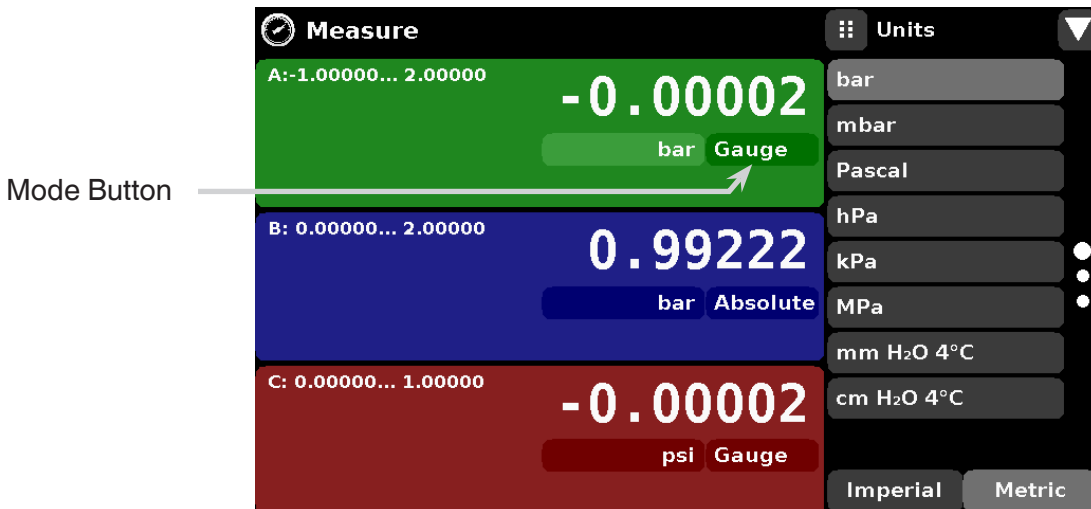

Figure 6.4.1-B - Units Change

6.4.1.1 Pressure Mode / Emulation Mode

The Mode button is only active if there is an optional Barometric reference installed. Otherwise, the mode button becomes a label (figure 6.4.1.1-A) indicating the native mode of the transducer (absolute or gauge) and disappears when the “% of range” units are selected (figure 6.4.1.1-B). When an optional barometric reference is installed, a native gauge transducer can emulate absolute pressure using the barometric reference. Alternatively, a native absolute transducer can emulate gauge pressure. Emulation can be activated simply by pressing the Mode button.

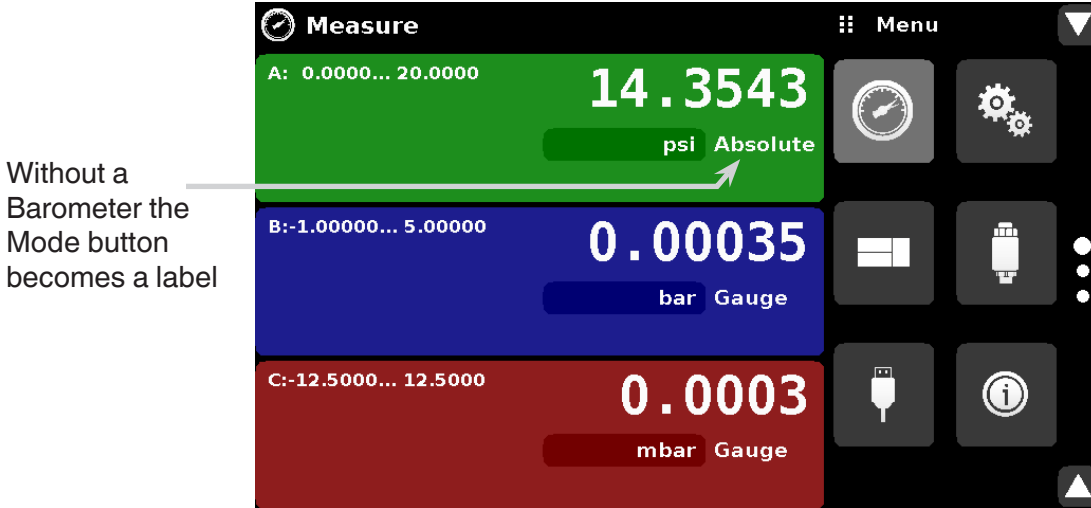

Figure 6.4.1.1-A - Mode Label

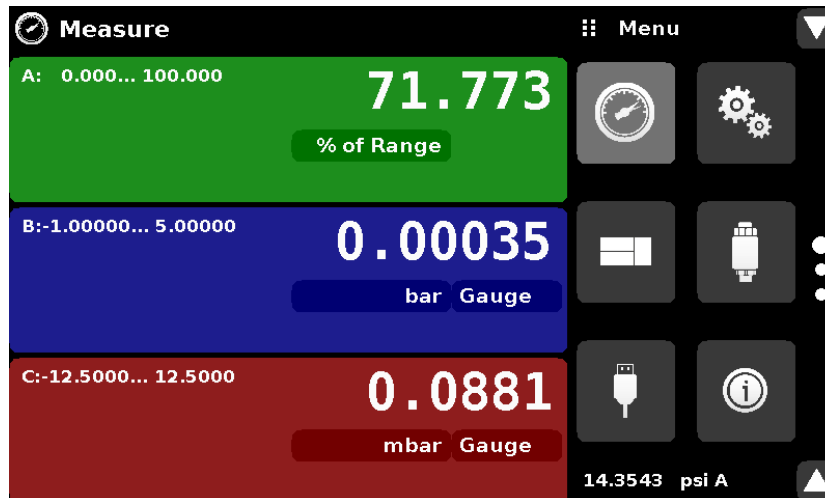

Figure 6.4.1.1-B - No Mode Button in “% of range”

Precision Pressure Indicator CPG2500

6.4.1.2 Auxiliary Displays

The screen in figure 6.4.1.2 shows all of the possible auxiliary display items that can be included in the Measure App, in addition, each channel can contain one of two possible calibration functions. The auxiliary display item includes “Alternate Units”, “Peak” and “Rate”. Calibration functions are either a “Zero” button or a “Tare” button. These auxiliary features will appear in the Measure App when selected from the Transducer App (section 6.4.4.4).



Figure 6.4.1.2 - Three channel Measure App with auxiliary displays

Auxiliary buttons can be placed in three different parts of the screen depending on how they are set in the Transducer Application. Each auxiliary display can be modified by pressing the displayed button.

Peak: Pressing the Peak button will reset the upper and lower peak value to the current reading, subsequent negative or positive divergence from that reading will be recorded in the button.

Rate: Pressing the Rate button will display a choice of rate time units for the rate denominator.

Units: Pressing the Auxiliary Units button will display the same set of units available for the primary units. To change auxiliary units (ie. bar to psi), press the auxiliary unit you want to change and select which unit you want displayed.

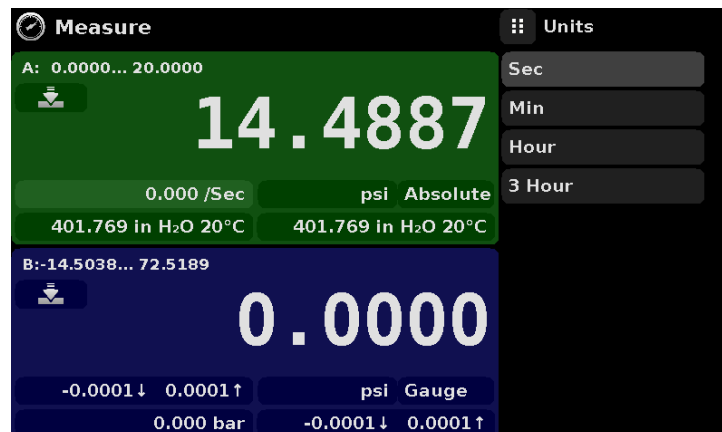

Figure 6.4.1.3 - Rate selected and unit options displayed

6.4.1.3 Zero Button

If the Zero Calibration function has been chosen in the Transducer App (section 6.4.4), then the Zero Cal Button [] will appear in the Measure App. If the channel is measuring absolute pressure, and the Zero Cal Button is pressed, a keyboard will appear to allow a single point calibration. If the channel is measuring gauge pressure, pressing the button will set the current reading to zero. If the channel is in emulation mode (absolute or gauge) then the value will not be saved to the sensor but only as a temporary adjustment while in emulation mode. After exiting the emulation mode or after a power cycle, the temporary adjustment will be cleared. The zero adjustment for a channel not in emulation mode will be saved to the sensor as if single point calibration had been performed.

Figure 6.4.1.4 shows two channels displayed, the zero cal function has been enabled for both channels. The screen on the left shows both channels with zero buttons. The screen on the right shows the same two channels, but the zero button on the absolute channel has been pressed, showing the keypad enabled to accept a new single point calibration value.

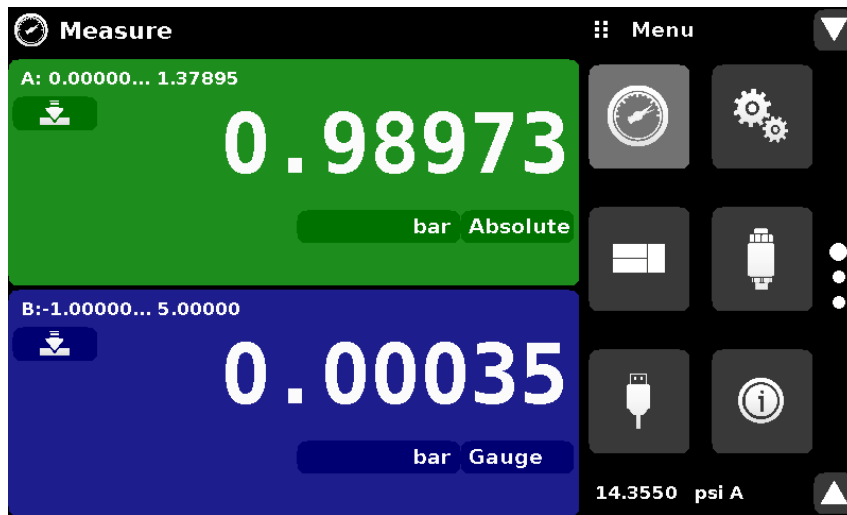

Figure 6.4.1.3-A - Zero Button, Gauge

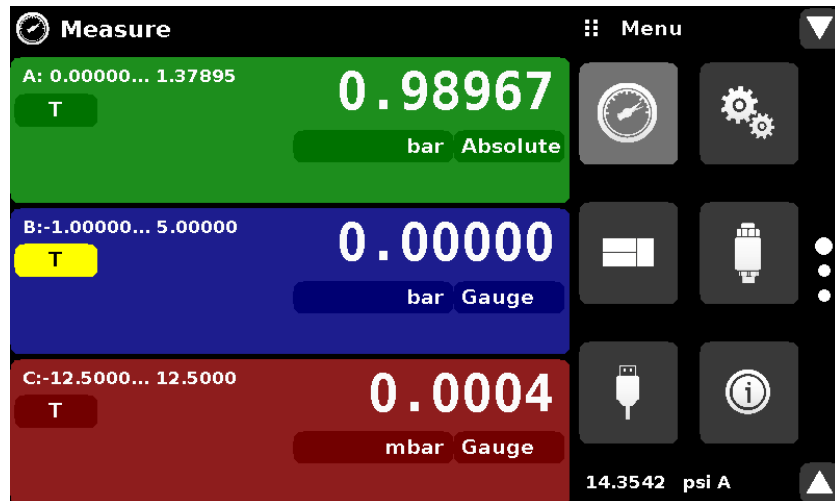

Figure 6.4.1.3-B - Zero Button, Absolute

The background color of the zero button will momentarily change to a lighter color as the zero calibration is performed then will revert back to a darker color when complete.

Precision Pressure Indicator CPG2500

6.4.1.4 Tare Button

If the Tare calibration function has been chosen in the Transducer App (section 6.4.4), then the Tare Button [**T**] will appear in the channel screen. The Tare button and the Zero Button cannot appear on the screen at the same time, in the same channel. When the Tare button is pressed, the instrument will subtract the current pressure reading (the tare pressure) so that the indicator will display zero. Subsequent deviations in pressure will be relative to the tare pressure. Notice in the figure below that, when inactive, the back ground of the tare button is the same as the channel background, when active the button is highlighted in yellow [**T**] to distinguish an active tare value. .

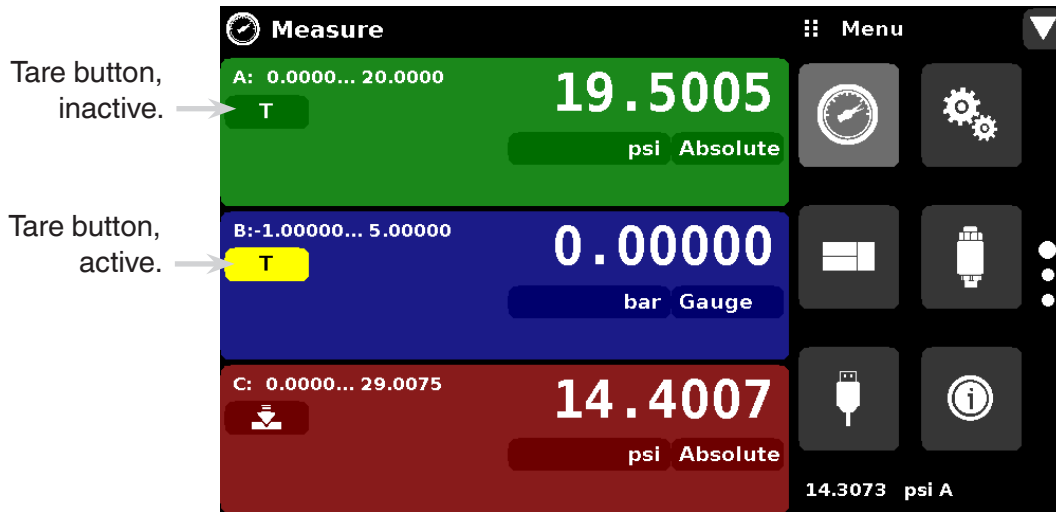

Figure 6.4.1.4 - Tare Button

Pressing the tare button again will deactivate the tare and change the pressure indication back to the reading corresponding to the calibrated output of the transducer. An active tare will revert to a deactivated state after a power cycle.

6.4.2 Settings Application



The Settings App is used to set up general settings for the display. Settings parameters include Language, Brightness, Volume, User 1 base units, User 1 multiplier, User 2 base units, User 2 multiplier, Barometer units, and Configuration. Figure 6.4.2 shows these parameters as indicated when the Settings App has been chosen. As each parameter is pressed, an input screen will appear on the right where selections can be made.

The Settings App provides a place to change the language, display brightness, volume, user units, and barometer units. Configuration settings of the unit can also be saved within this application plus the default configuration can be activated.

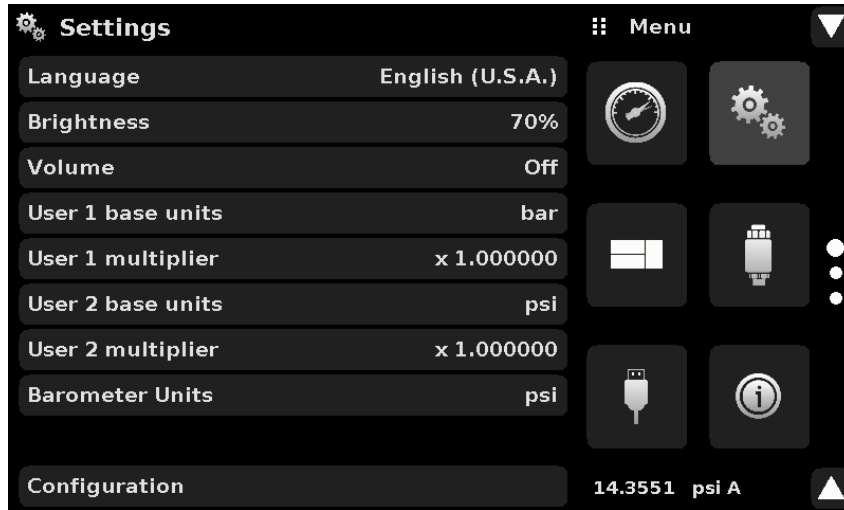

Figure 6.4.2 - Settings application

6.4.2.1 Languages

The Language parameter provides a selection of different languages. Once a language is chosen all words within all menus will appear in the chosen language and the radix character (decimal mark) will change from a dot (.) to a comma (,) depending on the language chosen.



Figure 6.4.2.1 - Languages

6.4.2.2 Brightness

The Brightness setting provides a sliding scale to increment the screen brightness in all screens. Sliding your finger along the bar graph or touching anywhere in the bar graph will change the brightness of the screen. After the setting is made and your finger is removed from the screen the menu will revert back to the basic settings menu.

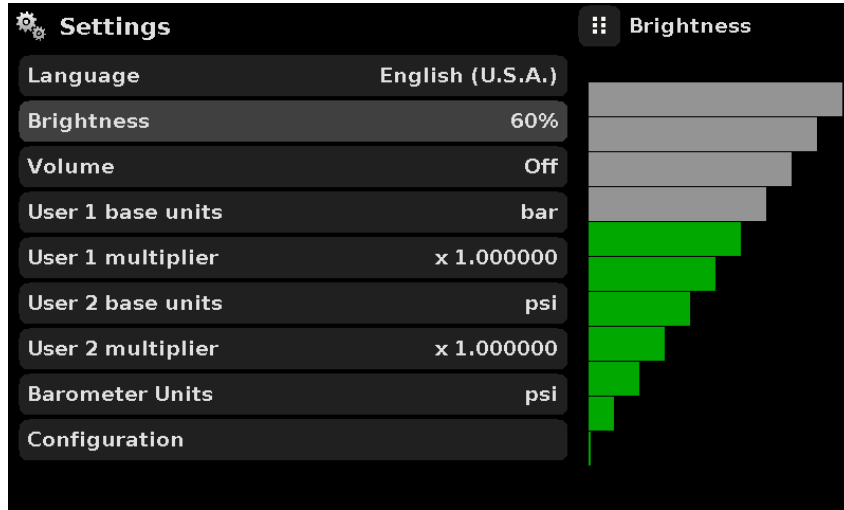

Figure 6.4.2.2 - Brightness

6.4.2.3 Volume

The Volume setting provides a way to turn on or off the touch screen audio feedback.

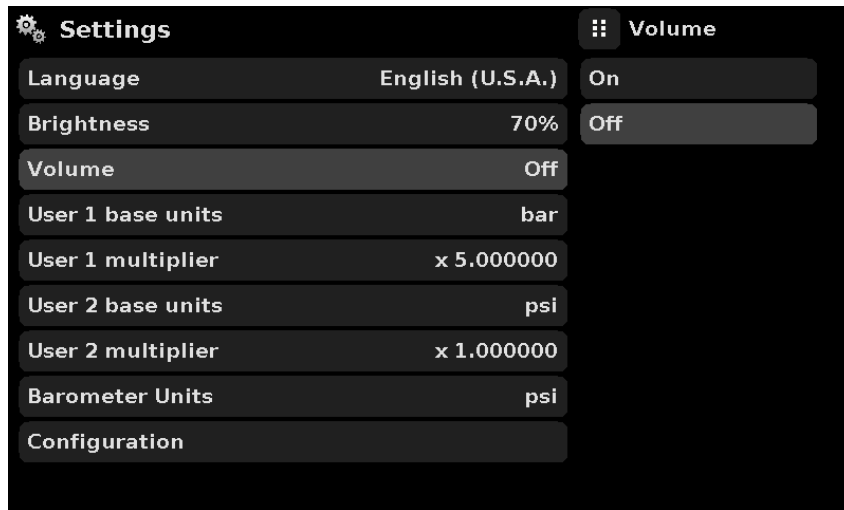

Figure 6.4.2.3 - Volume

6.4.2.4 User base units / Base units multiplier

When choosing a unit of measure from the Measure Application (main screen), standard units can be chosen in addition to two user defined units. User units 1 and 2 are defined in the Settings App using “User 1 base units”, “User 1 multiplier” and / or “User 2 base units”, “User 2 multiplier”. For example, if the display of one atmosphere (atm) was needed, then psi could be chosen as the “User 1 base unit” and the “User 1 multiplier”, in this case, would be 0.068045. When set this way and the user 1 unit has been chosen, the user 1 unit will now display the pressure in atm.

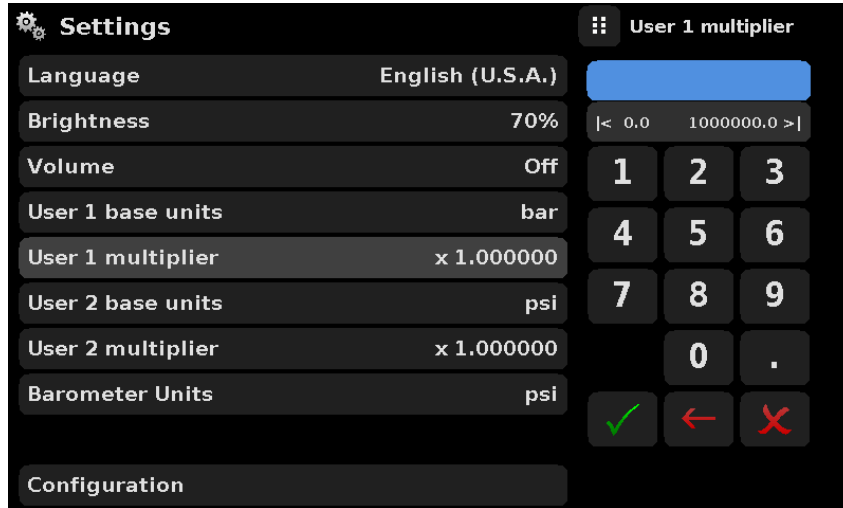

Figure 6.4.2.4 - User base units / Base units multiplier

6.4.2.5 Barometer Units

When the Barometer Units Parameter has been chosen, a list of Imperial or Metric units is presented on the right side of the screen. Any of these units can be chosen from this list for the barometric readout that can be seen on the bottom right of the Measure App.

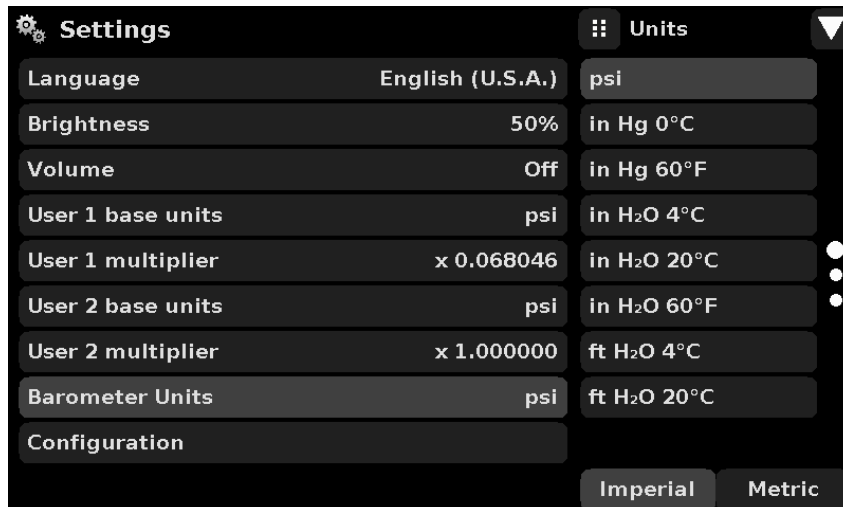

Figure 6.4.2.5 - Barometer units

6.4.2.6 Configuration

Configuration is the last parameter in the Settings App. It allows the operator to save instrument settings and load them, as needed, in the future. Parameters that are set in the Settings App, the Frames App, the Transducer App, and the Remote App can be saved using the Configuration “Save” button and recalled using the Configuration “Load” button. Simply set all desired parameters then go to Settings-Configuration, press one of the numbered Configuration buttons then press the “Save” button. This will save the current configuration in that button. To reload a saved configuration at a later time, go to Settings-Configuration and press the numbered configuration button corresponding to the saved configuration and then press the “Load” button.

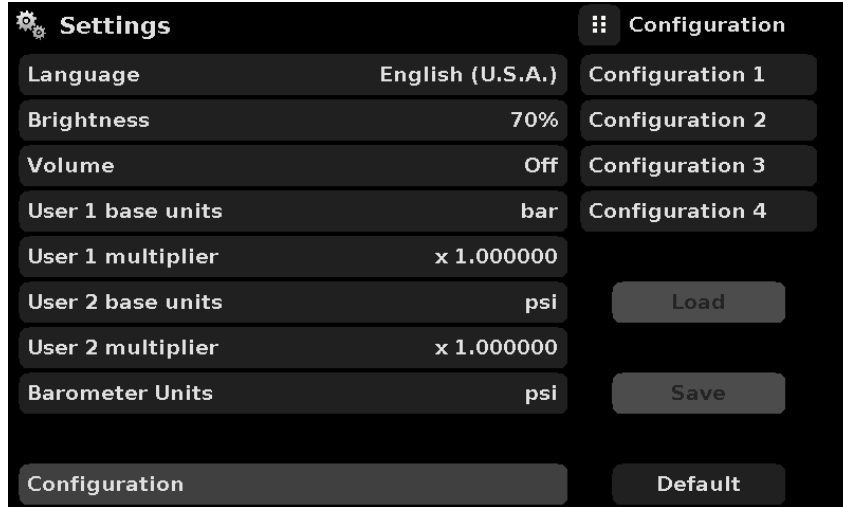

Figure 6.4.2.6 - Configuration

The instrument default configuration can be activated simply by pressing the “Default” Button.

6.4.3 Frames Application



The Frame App allows the user to select the number and order of the transducer channels displayed in the Measure Application. A total of three channels can be displayed at a time. Typically, if two internal transducers and one external transducer are installed the display will include three channels: A, B and Remote, in order from top to bottom. The order and number of channels displayed can be defined in the Frames Application. In addition the optional barometric reference transducer can be displayed as a channel as well as an emulated Delta channel. Figure 6.4.3 shows the unit in dual frame format with the Frame Format set to display the readings from two transducers (A & B in a dual frame mode).

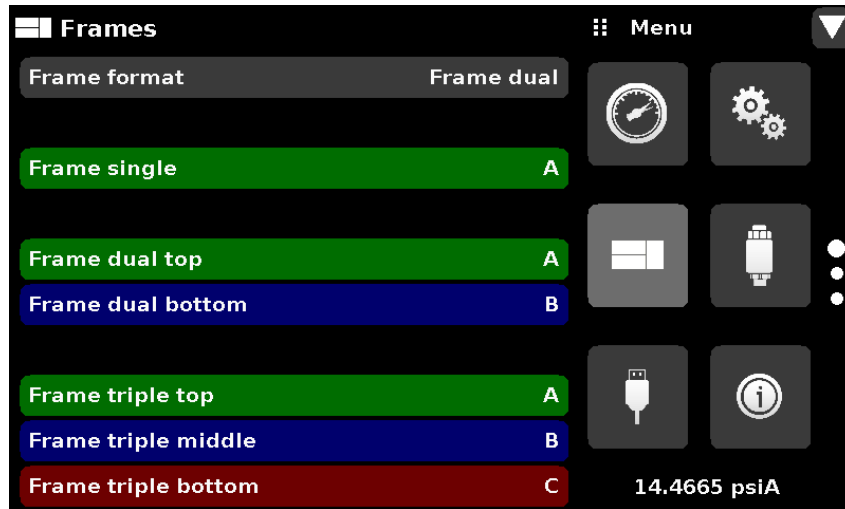

Figure 6.4.3 - Frames Application

6.4.3.1 Frame Format

The Frame format button sets the display in the Measure Application to Single Frame, Dual Frame or Triple Frame. Figure 6.4.3.1 shows the available selections for the Frame Format parameter.



Figure 6.4.3.1 - Frame Format

6.4.3.2 Frames Channel

The channel setting in the Frames application provides a way to choose which channel(s) appears and in what order within the Measure Application (Main Screen). Any installed transducer channel or the emulated Delta channel can be displayed in the Measure Application. In figure 6.4.3.2, the Dual Frame format is set in the Frames format parameter, channel A is set as the top frame and Channel B is set as the bottom frame. Channels A, B, Remote or Barometer could be placed in any available position. If the Single or Triple frame format is chosen then the channels will appear as shown in each of the respective frame position sets.

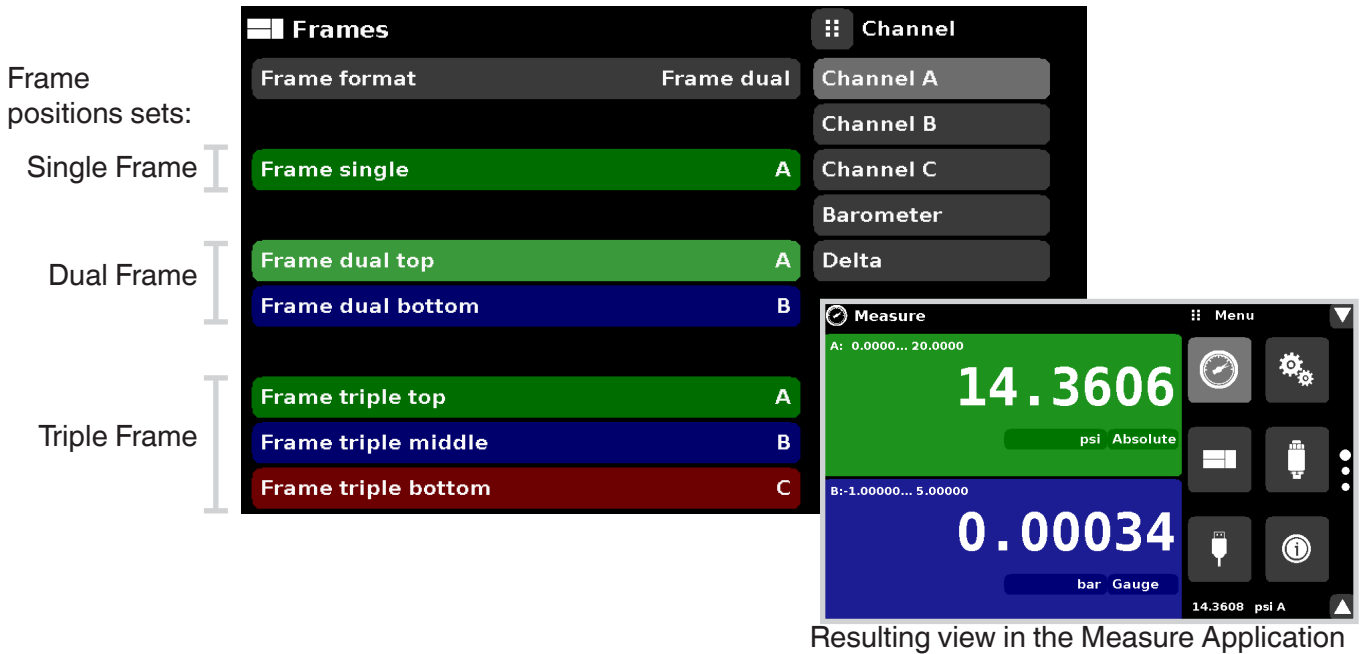

Figure 6.4.3.2 - Frames Channel

In Figure 6.4.3.2-A, the Channels have been set in order for each frame format and the frame format has been set to “Frame triple”. In the Measure App the resulting channel position will be: channel “A’ on top, Channel “B” in the middle and the “Delta” channel on the bottom. The barometer reading (if installed) will appear as a selectable channel and will always be in the bottom right under the application menu.

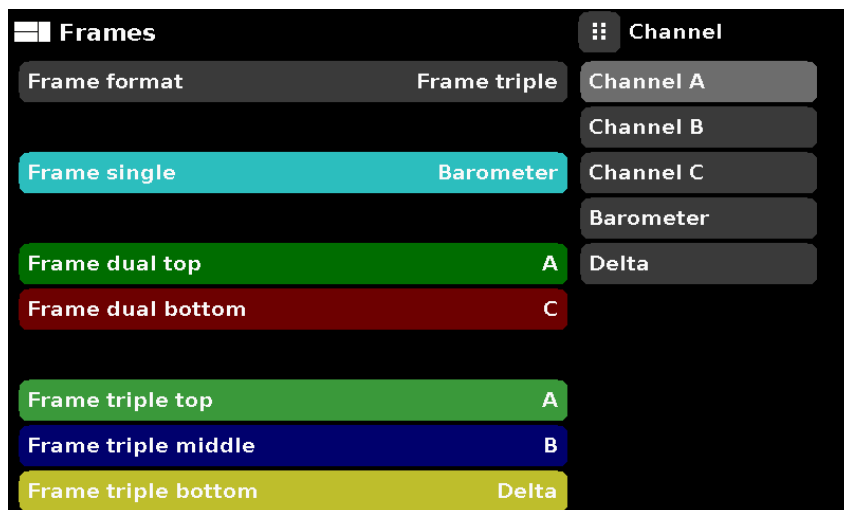

Figure 6.4.3.2-A - Example channel frame settings

6.4.4 Transducer Application



For each transducer, the Transducer Application provides a way to set the filter for the reading to reduce fluctuations due to electrical noise, and to set the resolution of the reading. In addition, the auxiliary display functions and calibration function can be specified here.

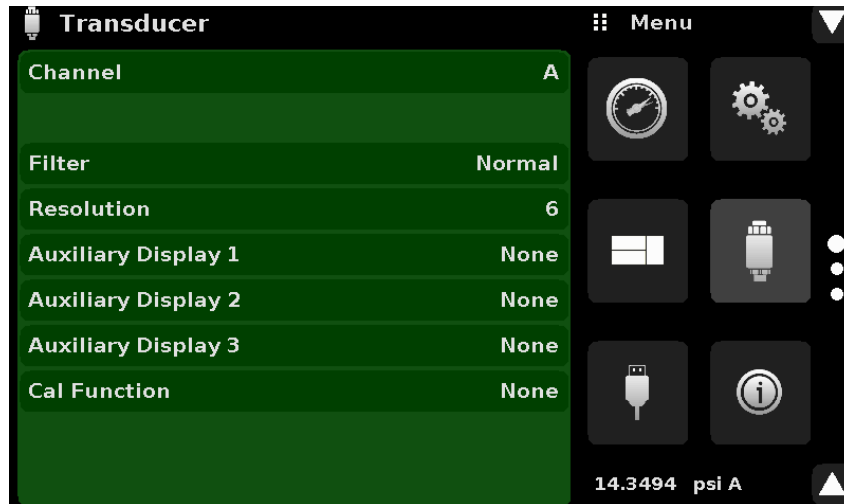

Figure 6.4.4 - Transducer Application

6.4.4.1 Transducer Channel Selection

To set the transducer parameters, the transducer channel must be selected. Transducer parameters are identical for all channels but can be set differently in each channel. Figure 6.4.4.1 shows two displays where channel “A” and “B” have been selected.

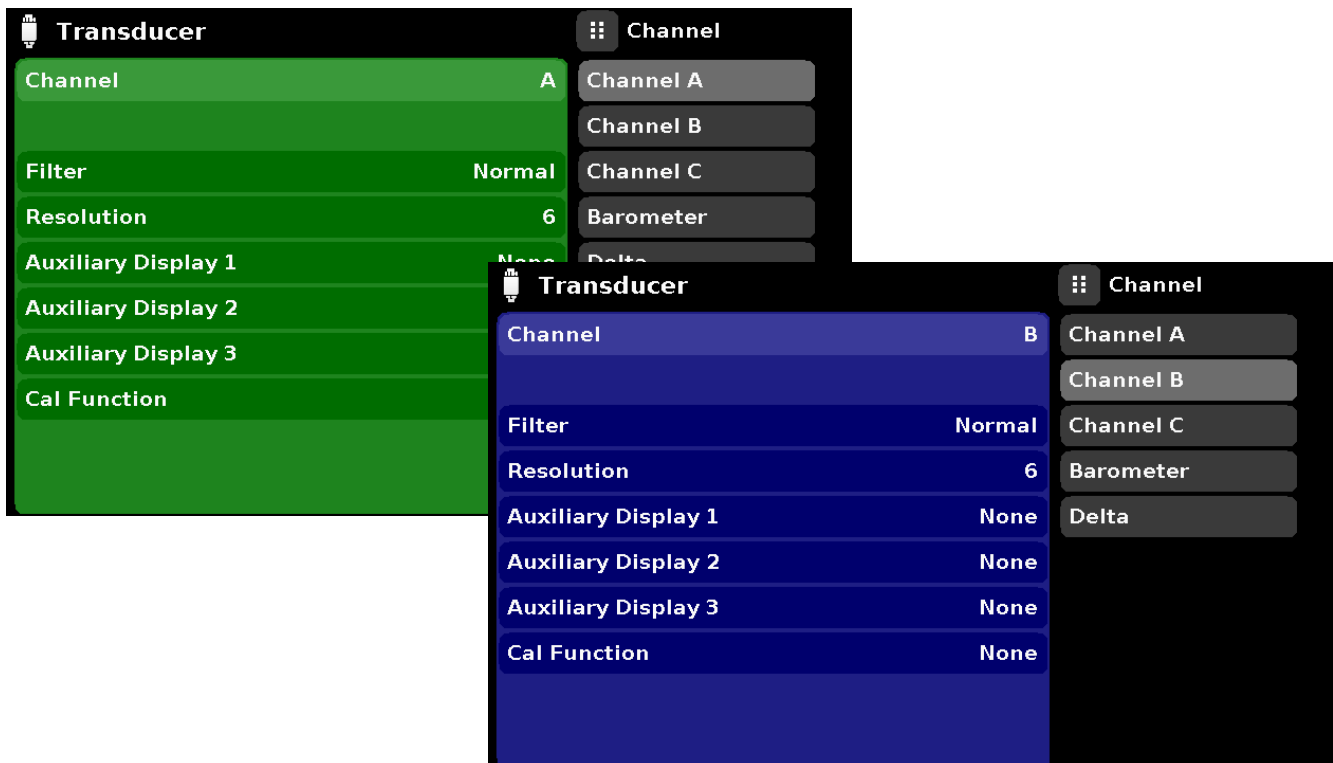

Figure 6.4.4.1 - Transducer Channel Selection

6.4.4.2 Transducer Delta Emulation

If there is more than one transducer installed, the Delta Channel option will appear as a selection in the Transducer App. The Delta channel has all of the regular transducer parameters aside from the cal function in addition to the Delta Function shown at the bottom of Figure 6.4.4.2. When the Delta Function is selected settings will appear that define the delta display (in the Measure App). All discrete combinations for adding or subtracting one channel from another are available as a selection. These combinations are shown below in Figure 6.4.4.2.

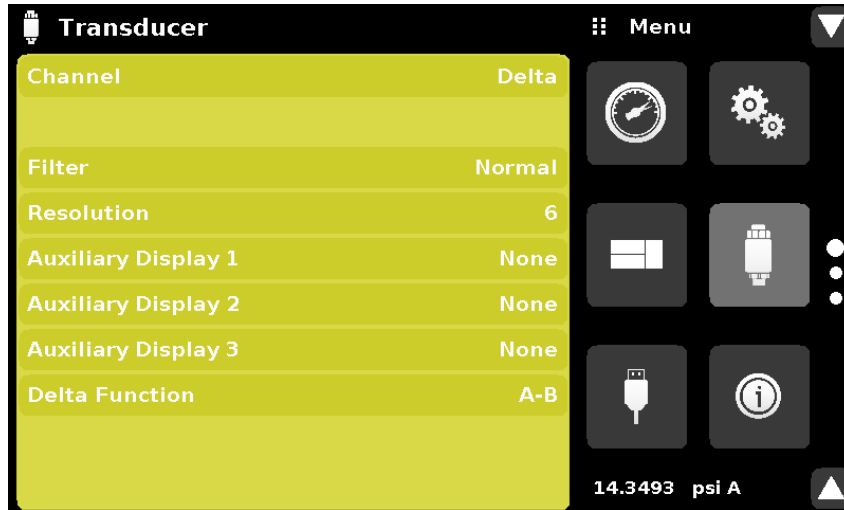

Figure 6.4.4.2 - Transducer Delta Emulation

6.4.4.3 Transducer Filter

The Filter is an electronic filter to smooth out the pressure readings. Because of differences in resolution, greater filtering may display a more stable reading for some pressure units. Turn off the Filter by selecting “Off”, select varying degrees of filtering for the current units by selecting “Low”, “Normal” or “High”.

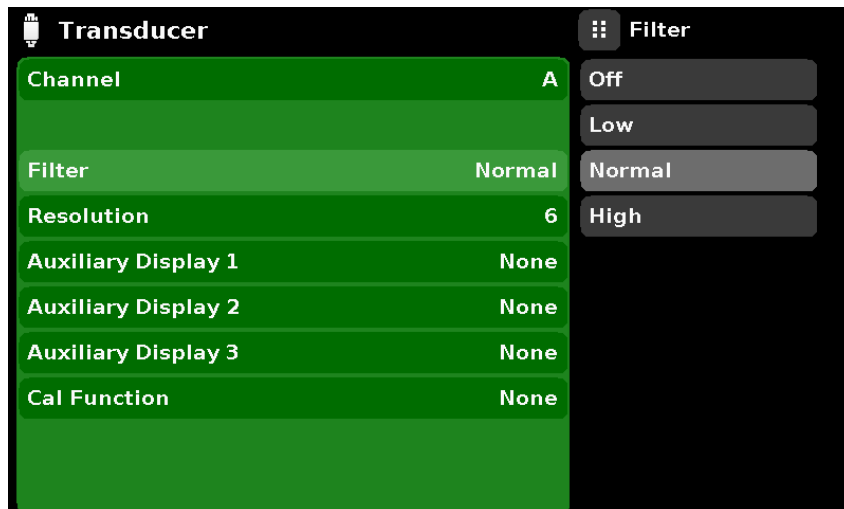

Figure 6.4.4.3 - Transducer Filter

6.4.4.4 Transducer Resolution

The resolution of each transducer channel can be set in the Transducer Application using the resolution parameter. The resolution can be set to 4, 5, 6 or 7 digits.

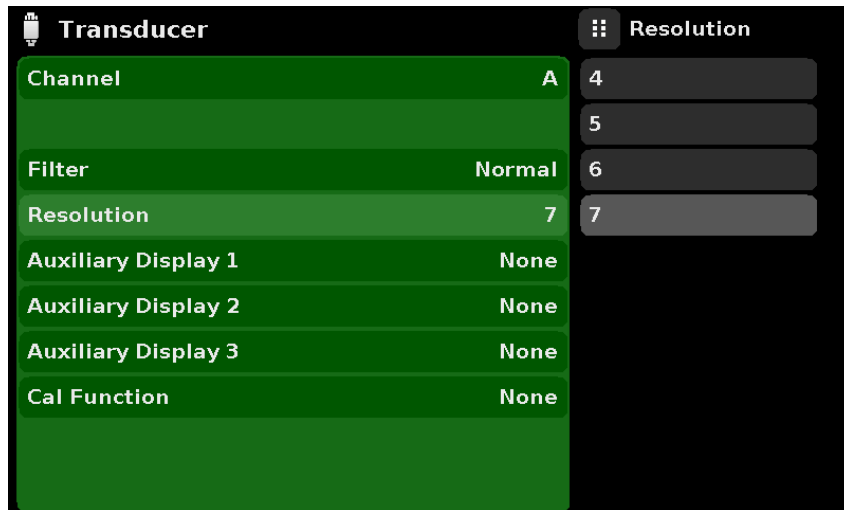

Figure 6.4.4.4 - Transducer Resolution

6.4.4.5 Auxiliary Displays

The Transducer Channel Auxiliary Display(s) can be set in the Transducer App by selecting Auxiliary Display 1, 2 or 3 and selecting from, None, Peak, Rate or Units. Figure 6.4.4.5-A shows auxiliary display 1, 2 and 3 set for units, peak and rate respectively. Auxiliary displays will appear in the Measure App as seen in Figure 6.4.4.5-B.

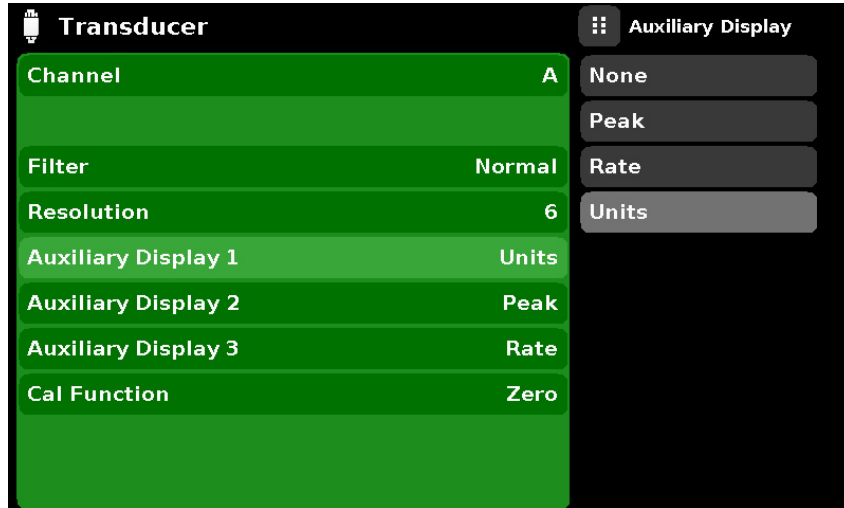

Figure 6.4.4.5-A - Transducer channel aux displays set to Units, Peak and Rate

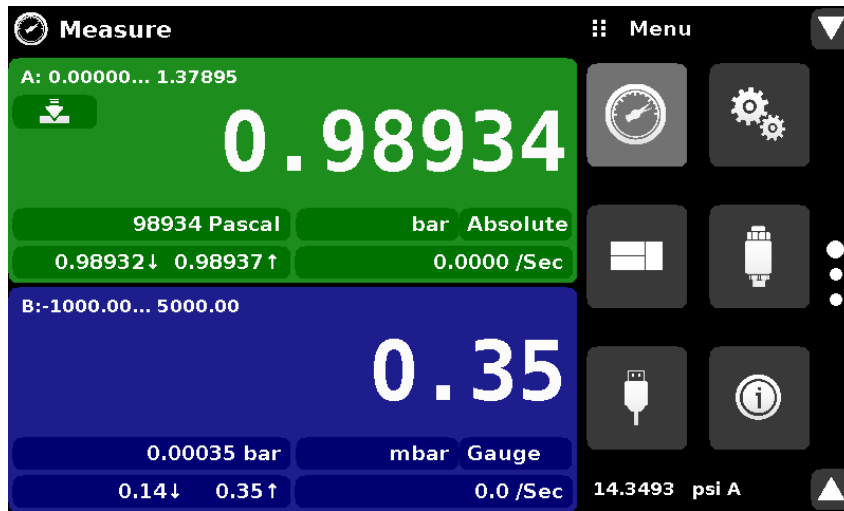



Figure 6.4.4.5-B - Auxiliary displays as seen in the Measure App

6.4.4.6 Cal Function

The Transducer Cal Function presents a choice of None, Tare or Zero. Choosing Zero will enable the Zero Cal Button [] in the Measure App. Choosing Tare will enable the Tare Button [] in the Measure App. The Tare button and the Zero Button cannot appear on the screen at the same time, in the same channel. See section 6.4.1.3 and 6.4.1.4 for operation of the Zero and Tare buttons in the Measure App (main screen).

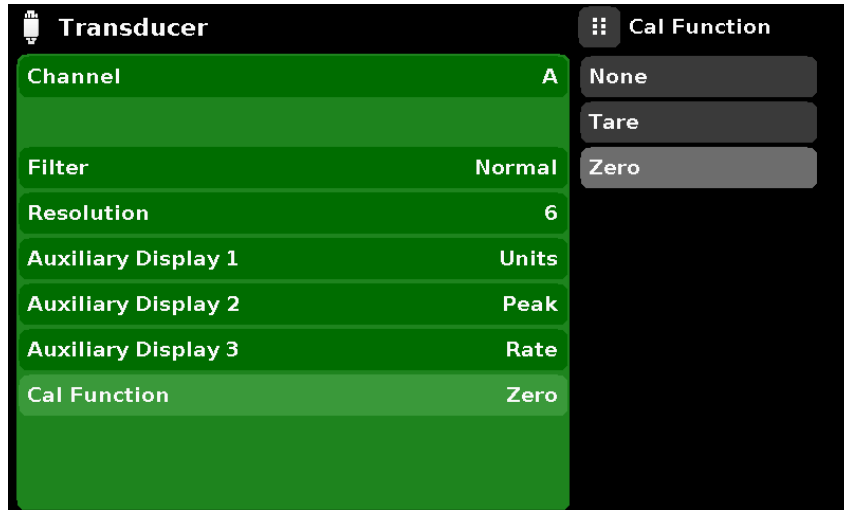

Figure 6.4.4.6 - Cal Function

Precision Pressure Indicator CPG2500

6.4.5 Remote Application

With the remote application you can select the remote command set for all interfaces. The GPIB address, Ethernet network parameters and Serial parameters can also be set here.

Details about the Remote Operation (command sets, cable requirements, etc.) can be found in Section 7, Remote Operation.

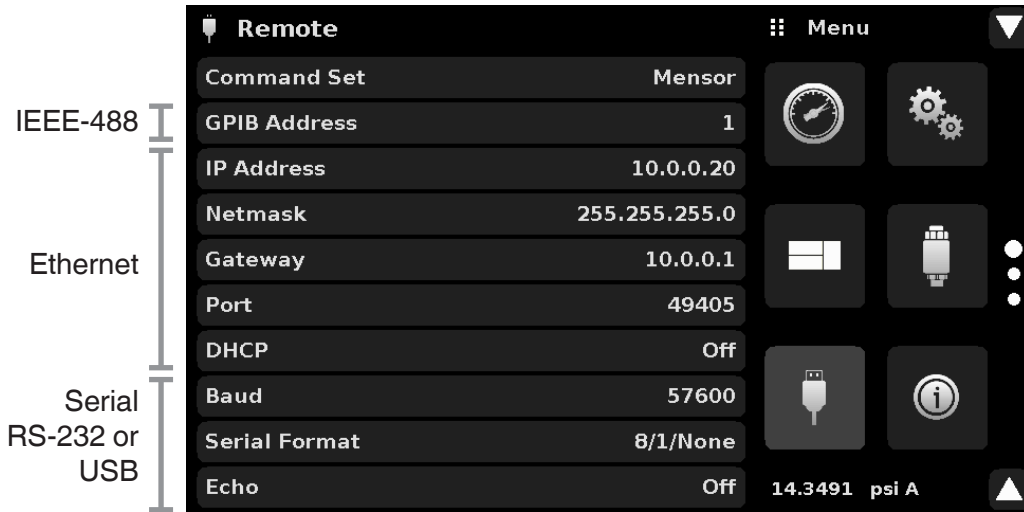

Figure 6.4.5 - Remote Application

6.4.5.1 Remote Command Set

The remote command set parameter provides a choice of the Mensor command set or the WIKA SCPI command set. Both sets of commands are listed in Section 7, Remote Operation.

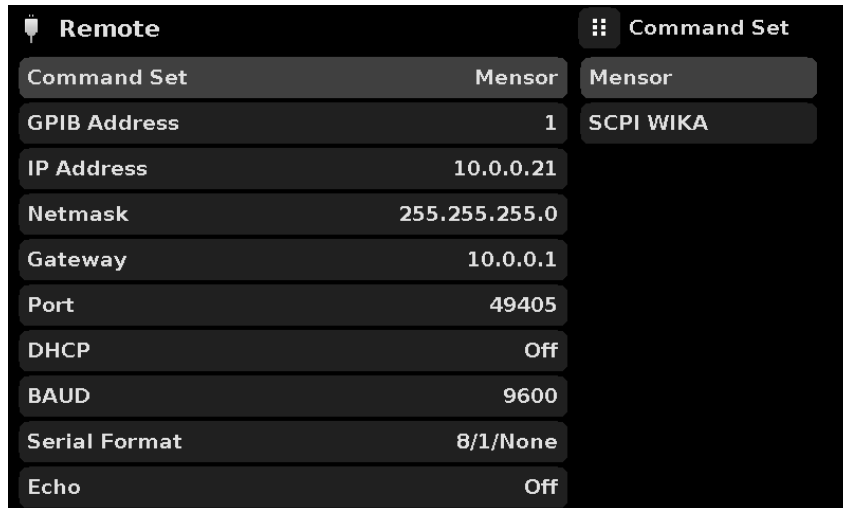

Figure 6.4.5.1 - Remote Command Set

6.4.5.2 Remote Communication Settings

The remainder of the Parameters in the Remote Application present the choice of a numeric entry, a numeric address entry, or a radio button selection. The parameters that require a numeric entry will present a numeric keypad with min and max limits for the variable. The parameters that require a numeric address (for example an IP address) will also present a keypad. Address entries should conform to the format of the parameter selected. The three screens below show examples of each type.

The screenshot shows the 'Remote' application interface with the 'GPIB Address' parameter selected. The parameter value is '1'. A numeric keypad is displayed on the right, with buttons for digits 0-9, a green checkmark, a red back arrow, and a red 'X'.

Command Set	Mensor	1
GPIB Address	1	↓ 1 31 ↑
IP Address	10.0.0.21	1 2 3
Netmask	255.255.255.0	4 5 6
Gateway	10.0.0.1	7 8 9
Port	49405	0
DHCP	Off	✓ ← ✗
BAUD	9600	
Serial Format	8/1/None	
Echo	Off	

Numeric entry

The screenshot shows the 'Remote' application interface with the 'IP Address' parameter selected. The parameter value is '10.0.0.21'. A numeric keypad is displayed on the right, with buttons for digits 0-9, a period, a green checkmark, a red back arrow, and a red 'X'.

Command Set	Mensor	10.0.0.21
GPIB Address	1	
IP Address	10.0.0.21	1 2 3
Netmask	255.255.255.0	4 5 6
Gateway	10.0.0.1	7 8 9
Port	49405	0 .
DHCP	Off	✓ ← ✗
BAUD	9600	
Serial Format	8/1/None	
Echo	Off	

Numeric address entry

The screenshot shows the 'Remote' application interface with the 'DHCP' parameter selected. The parameter value is 'Off'. The 'On' and 'Off' radio buttons are visible.

Command Set	Mensor	On
GPIB Address	1	Off
IP Address	10.0.0.21	
Netmask	255.255.255.0	
Gateway	10.0.0.1	
Port	49405	
DHCP	Off	
BAUD	9600	
Serial Format	8/1/None	
Echo	Off	

Radio button selection



Setting the Ethernet DHCP to yes will have a short delay while the DHCP server is contacted. If a DHCP server is not found, an error will be indicated. If DHCP is enabled, the IP address, Netmask and Gateway are greyed out and locked, these are controlled by the DHCP server.

Figure 6.4.5.2 - Remote Communication Settings

Precision Pressure Indicator CPG2500

6.4.6 Info Application



The Info application displays information about the instrument, including:

- Mensor address, and email
- Model number, serial number and operating software version.
- Sensor model number, serial number, range, software version

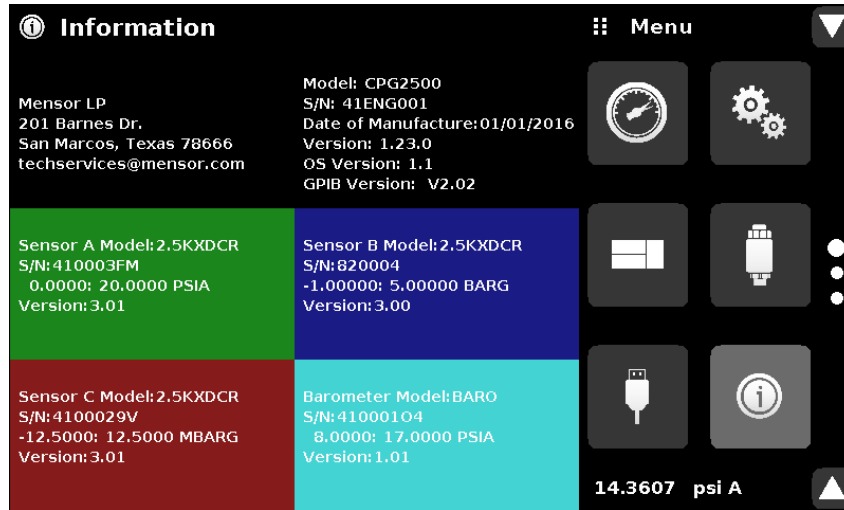

Figure 6.4.6 - Info Application

6.4.7 Leak Test Application



The Leak Test application provides a way to check the system for leaks into or out of the system. This App is found on the second page of the Apps menu accessed by pressing the page down button [▼].

The operator defines a leak by setting the Time parameter and the Delta parameter. With the system pressurized to a predetermined amount, the leak test is initiated by pressing the Start button. If the change in pressure exceeds the Delta parameter before the allotted time in the Time parameter, then the Leak Test App will return a red status indication showing the actual difference (delta) in pressure recorded during time period set in the leak test, indicating a “failed” test. Otherwise it will return a green status indication showing that the delta was not exceeded for the time period, indicating a “passed” test. The Leak Test App also provides information on the initial, final and delta pressure change in a tabular form next to the active pressure reading. See Figure 6.4.7-A for examples of a failed and a passed test.

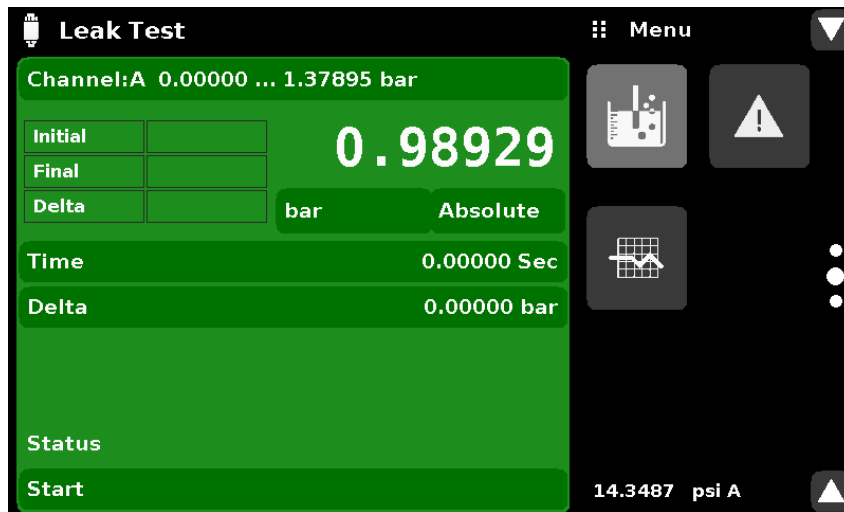

Figure 6.4.7 - Leak Test

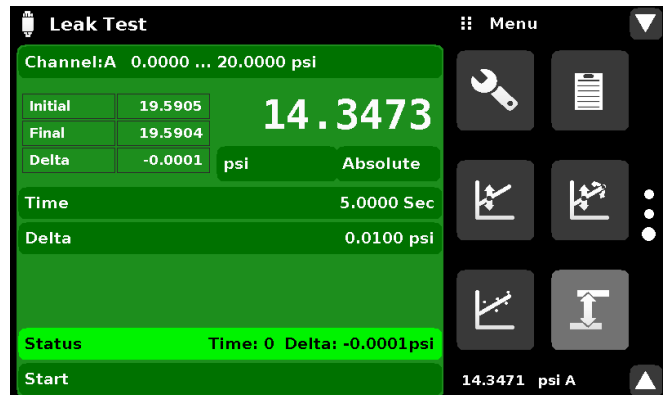
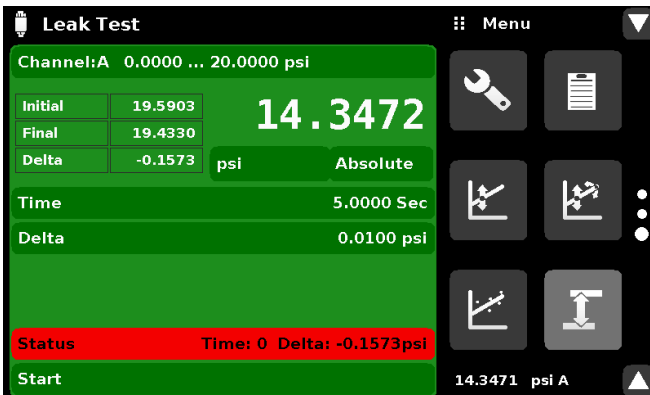

Figure 6.4.7-A - Leak test fail (left) & Leak test pass (right)

Precision Pressure Indicator CPG2500

6.4.8 Troubleshooting Application



The Troubleshoot Application will display information about error conditions and remote communications. Within the troubleshoot screen (Figure 6.4.8-B), push the Error button to display any errors that have occurred in the instrument due to a communication or network error. Push the Remote button to show commands and responses that have been sent over the remote communication connection.

If there are any errors in the error queue an error symbol [] will appear in all screens (Figure 6.4.8-A) of the instrument. Pressing this error button from any screen will open the Troubleshoot application where the error can be viewed.



Figure 6.4.8-A - Error indication

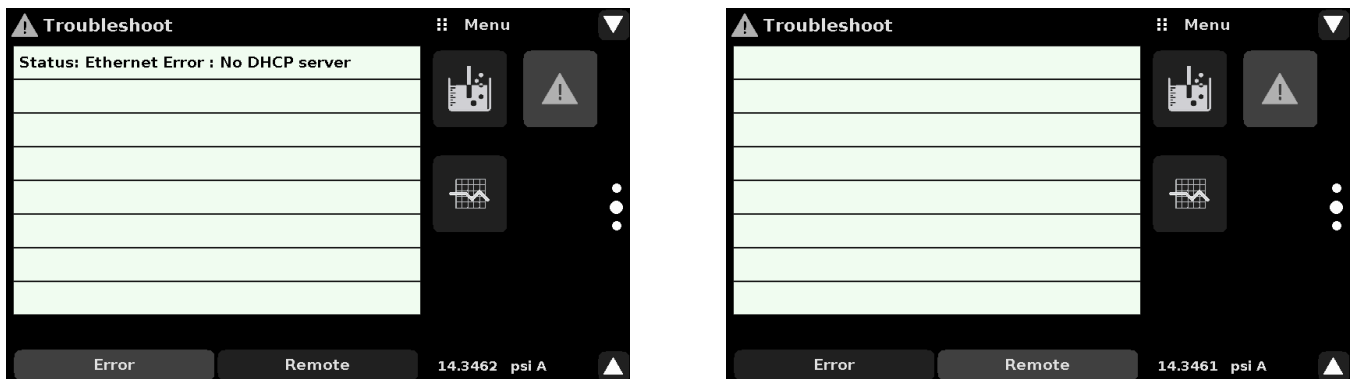
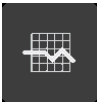

Figure 6.4.8-B - Troubleshoot error and remote

6.4.9 Logging Application



The logging application enables real-time storage of current instrument output and state in a USB device plugged to the front panel of the CPG2500. The application also provides a means to log any remote communication (commands and responses) to the instrument. The primary objective of this application is to provide test data for troubleshooting purposes.



Note: The Logging Application is only visible when a compatible USB device is plugged to the front panel of the CPG2500. The Application is greyed out in the absence of a USB device.

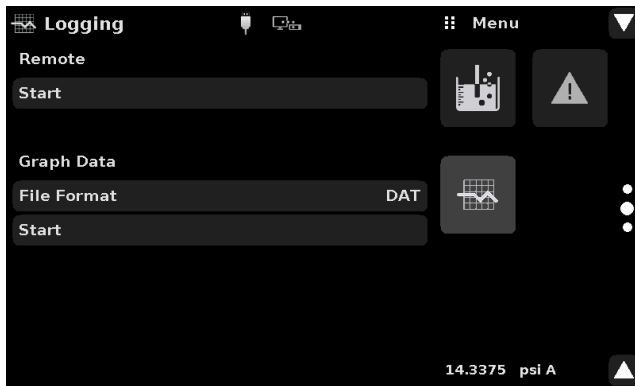



Figure 6.4.9-A Logging Application with USB (left) and without USB (right)

6.4.9.1 Remote Logging

The queries and responses sent over the remote communication can be logged on to the USB device using the remote logging feature. This feature allows monitoring communication and any erroneous responses from the instrument. The logging can be started by pressing the “Start” line, this would bring a keypad on the screen (Figure 6.4.9.1) for entering the file name to store the logging data. The extension of this file is set to “.txt” by default. Click [] to exit the keypad. This will automatically generate the file on the USB device and start logging the remote commands. The log function continues to run in the background while the instrument is operated locally or remotely. To stop logging, press the “Stop” line.

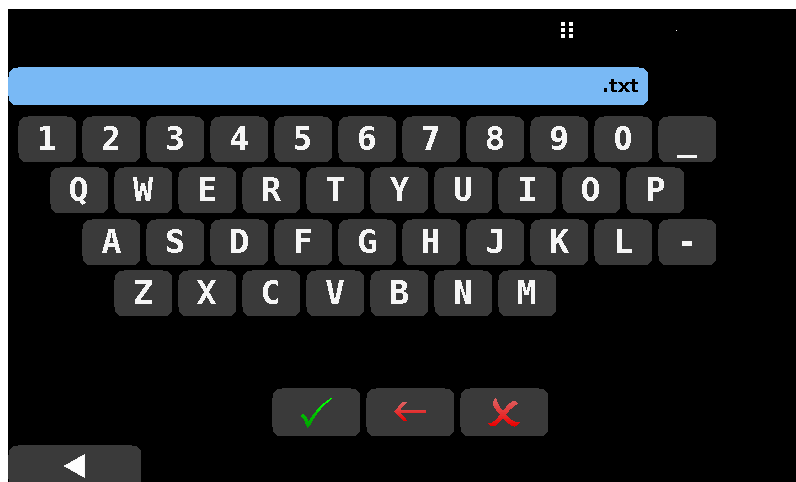



Figure 6.4.9.1 File Name Keypad

Precision Pressure Indicator CPG2500

6.4.9.2 Pressure Logging

The Logging App allows the storage of the time interval, active pressure and rate reading from all channels of the instrument to a file. The “File format” button provides selection of “.DAT” or “.CSV” file type. The logging is started by pressing the “Start” line, entering a file name on the alpha numeric keypad (Figure 6.4.9.2-A) and clicking []. The values are continuously written to the file until “Stop saving to” line is pressed (Figure 6.4.9.2-B).

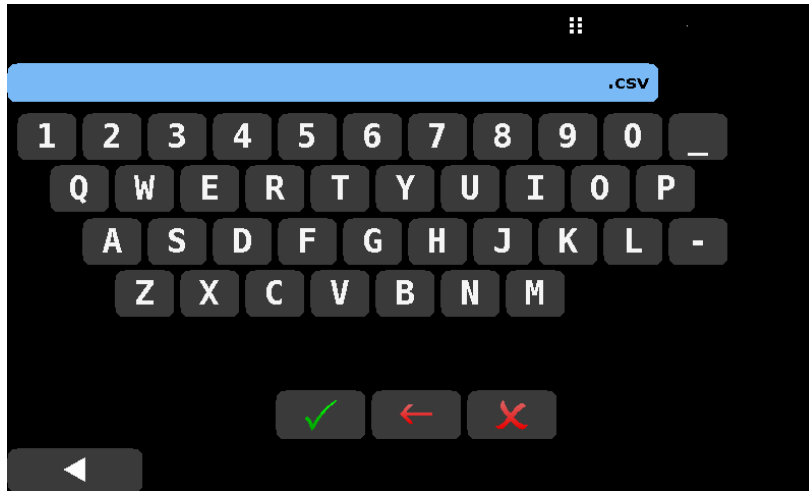

Figure 6.4.9.2-A File name keypad with “.csv” format

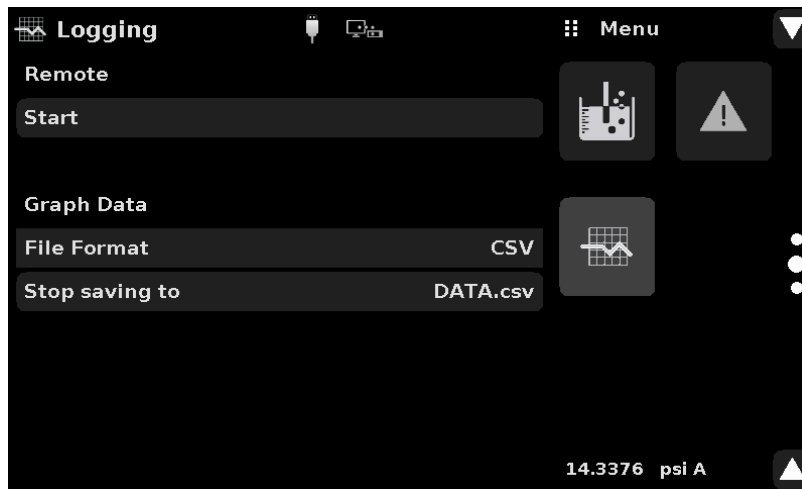

Figure 6.4.9.2-B Pressure logging active



Note: Once all the activity inside the Logging Application is over, press the USB icon in the top bar of display and click “Remove USB Device” to safely disconnect the USB device.

6.4.10 Service Application



The service application is a password protected area where calibration of all connected sensors can be accomplished. In addition, this is where the password for entering this area can be changed.

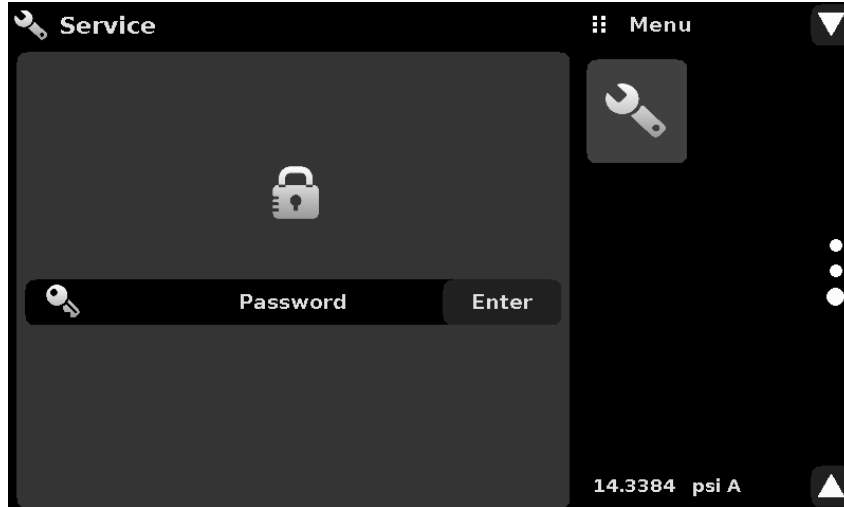



Figure 6.4.10-A - Service Application (locked)

Press the Enter button to show the numeric keypad to enter a password. This will unlock other applications. Default password is 123456. Enter 123456 and press the check mark [] to unlock the Service Application.

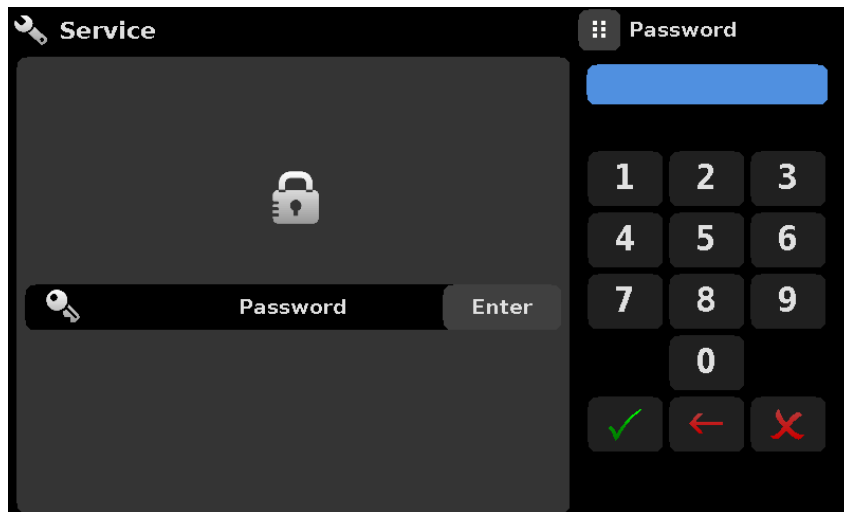

Figure 6.4.10-B - Service Application (Enter Password)



Note: The default Password is 123456. After entering this for the first time, the password can be changed.

6.4.11 Unlocked Service Application

After the Password has been entered, the unlocked Service Application will appear (Figure 6.4.11). To re-lock this screen, press the lock button.

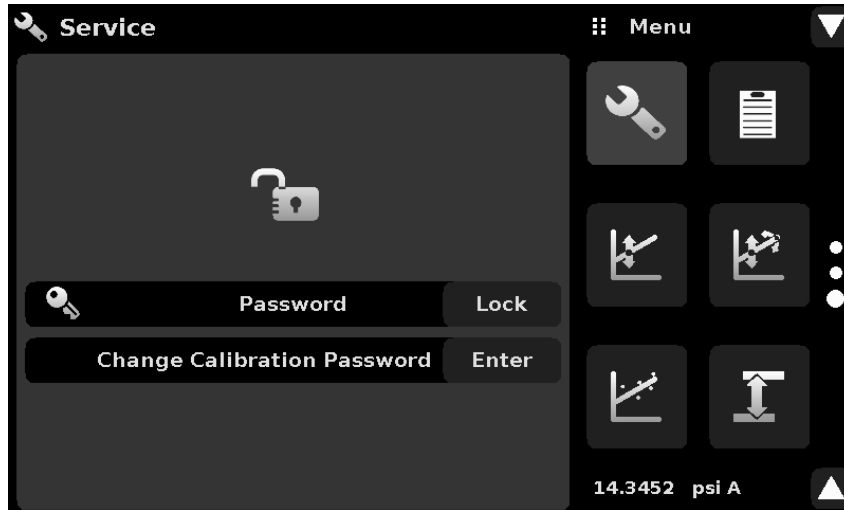



Figure 6.4.11 - Unlocked Service Application

From the Unlocked Service Application, the Password can be changed by pressing the Enter button next to the Change Password label. This will open a keypad where a new password can be entered and accepted by pressing the Check Mark [].



Note: Please make note of a password change and save the new password in a secure location.

The Unlocked Service Application is the access point to all calibration screens described in Section 10 of this manual.



Note: Recommended calibration setup and explanation of calibration screen applications is covered in Section 10 of this manual.

NOTES

7 Remote Operation

Use the screens in Section 6.4.5 Remote Application to set the operating parameters for the instrument command set, Ethernet, Serial (RS-232) and IEEE-488 (GPIB) information.

7.1 Command Set

Command Set button – Users' can select which model remote protocol they would like to emulate for simulation and testing purposes. Selections may include the following or may be added per customers' specifications:

- Mensor (default)
- SCPI WIKA (The SCPI WIKA mode emulates the WIKA command set in SCPI format.)

7.2 IEEE-488

IEEE-488 address button – Allows the user to set the GPIB address by inputting a numeric value utilizing the touch screen.

7.2.1 IEEE-488.2 Commands

Command or Query	Response / Function
*IDN?	Returns identification string
*RST	Reset to known state (default+psi)
*TST?	Returns 1
*OPC	Operation completed
*WAI	Returns operation completed state
*CLS	Clear status and error queue
*ESE	Enable status event
*ESE?	Returns enable status even value
*ESR	Event status register
*ESR?	Returns even status register value
*SRE	Service request enable
*SRE?	Returns service request enable value
*STB?	Returns status byte

7.3 Ethernet

The Ethernet function allows the user to set the following by inputting a numeric value in each separate field:

- IP
- Netmask
- Gateway
- Port
- DHCP settings

Set the Ethernet communication parameters as described in Section 6.4.5.



Caution

CAUTION: Please contact your network administrator for proper settings.



Caution

CAUTION: Please consult your computer resources department prior to connecting this instrument to your network to verify there are no conflicts with existing IP addresses.

The Ethernet communication port allows the CPG2500 to communicate with computers using 10/100Based-T specifications.

Before using Ethernet communication, four parameters must be set up: IP, Netmask, Gateway, and Port.

Precision Pressure Indicator CPG2500

7.4 Serial

Set the Serial communication parameters as shown in Section 6.4.5 Remote Application. The serial communication port allows the CPG2500 to communicate in RS-232 format with computers, terminals, PDAs, or similar hosts.

These parameters should be set to match your host computer. Default settings are: 57600 baud, 8 data bits, 1 stop bit, no parity, and no echo.

If echo is ON, the CPG2500 will immediately echo back characters sent over the serial port. The Serial function allows the user to set the RS-232 serial port settings by selecting from the choices provided:

- Baud
 - 9600
 - 19200
 - 38400
 - 57600
 - 115200
- Data Bits
 - 7
 - 8
- Stop Bits
 - 1
 - 2
- Parity
 - Even
 - Odd
 - None
- Echo settings
 - On
 - Off

7.4.1 Serial Cable Requirements

RS-232 communications are transmitted over a three conductor, shielded cable terminated in a standard DB9 connector on the instrument end, and a different gender connector on the host end. The proper pin-outs are shown in the following illustration.



Caution

CAUTION: When replacing an older model DPG 2100, the serial cable should be replaced with a straight cable or a null-modem inserted in the line.



7.5 Mensor Command Set

This Mensor command set is the default on the CPG2500. For queries (ending with a ?), the Data column represents the response of the CPG2500. All response strings begin with a space character or an “E” representing that there is an error in the error queue. All response strings are terminated with a <CR> and a <LF>. The error queue holds the last 10 errors identified.

For all commands (no ?), the data column represents the required parameters to be sent to the CPG2500 following the string in the command column. For any command that requires multiple parameters to be sent, the parameters must be separated by commas.

7.6 Command and Query Format

Commands must be sent in ASCII format and terminated with either a carriage return (<cr>), linefeed (<lf>), or both. Commands are not case sensitive. Each query returns a response. If an error is detected the response will include an error flag.

Command or Query field: Unless otherwise specified, commands are typically converted to queries by appending a question mark to the command. Table 7.9 lists all of the CPG2500 command or query keywords.

Data field: The data field is either in ASCII {string} or numeric {value} form. In the case of multiple data fields, commas are required to separate the fields. Queries do not have a data field. String (text) or value (numeric) data are acceptable in any of the following formats:

Examples of {string} data: ON, OFF, mBar, inHg

Examples of {value} data: 1, 1.0, -5.678, 25.68324e-5

7.7 Command Set Definitions

In this manual a data entry made up of alpha characters is defined as a string, as opposed to data containing only numbers, such as “Enter 1 for ON or 0 for OFF” where 1 and 0 are defined as values.

Command: Any command or query listed in Table 7.9. For commands that take boolean data the following strings are acceptable:

0	1
False	True
No	Yes
Off	On

Separator: Space (SP).

Data: ASCII representations of numbers, {value}, or alpha characters, {string}, data as defined above. When sending code a literal variable replaces the brackets and the enclosed character(s) shown in the following examples.

Termination: Linefeed (LF) or carriage return (CR) is used to signal the end of a command statement. For IEEE-488.2 operation “EOI” is an acceptable alternative.

Always send commands in one of the following formats:

1. [Command] [Termination];
2. [Command] [Separator] [Data] [Termination];
3. Queries are special instructions in the form: [Command?] [Termination] where the question mark, “?”, immediately precedes the terminator.

When a valid query is received, the CPG2500 will return {data} terminated by CR and LF. Floating point data is returned in the current engineering units in exponential format.

Precision Pressure Indicator CPG2500

7.8 Output Formats

Pressure readings are returned in exponential notation in a format according to the **OUTFORM** command as follows. Outform applies to both pressure channels.

1. <sp> pressure value <cr><lf>
2. <sp> pressure, units number, STANDBY <cr><lf>
3. <sp> pressure, pressure rate <cr><lf>
4. <sp> pressure, minimum peak, maximum peak <cr><lf>

7.9 CPG2500 Commands and Queries

Table 7.9 lists all of the current CPG2500 commands and queries.



Notice

**Channel specific commands are sent to only the active channel.
See 'CHAN' command.**

Optional emulation modes are available in which a CPG2500 can emulate remote functions of different brands of pressure gauges. Please contact Mensor for more details.

Table 7.9 - CPG2500 Commands and Queries

Command	Data	Response/Function
?	See Table Below	Returns data per the current output format
A?	<sp>n.nnnnnE+nn<cr><lf>	Returns the A channel pressure reading
AB?	<sp>n.nnnnnE+nn, n.nnnnnE+nn<cr><lf>	Returns A and B channel pressure readings. Returns Zero if no transducer is connected.
ABCBaro?	<sp>n.nnnnnE+nn, n.nnnnnE+nn, n.nnnnnE+nn, n.nnnnnE+nn<cr><lf>	Returns A, B, C, and Barometer channel readings. Returns Zero if no transducer is connected.
AR?	<sp>n.nnnnnE+nn<cr><lf>	Returns the A channel rate
Accuracyst?	<sp>cccccccc<cr><lf> Ex: 0.010% IS-50	Returns the accuracy string of the sensor on the active channel.
Acquire?	15 char string. Ex: Acquire? Test_stand_1 Returns: <sp>(YES or NO), CCC... CCC<cr><lf>	This command is used when multiple computers would like to control the instrument. Yes if acquisition is successful. No if instrument is being controlled with another computer. See: Release? and Unlock
ActualPress <n>, <f>	n, f	Set the linearity actual pressure for segmentn, where n is 0 to 10

ActualPress? <n>, <f>	<sp>n.nnnnnE+nn<cr><lf>	Returns the linearity actual pressure for segment n, where n is 0 to 10
Address	1-31	Sets the GPIB Address
Address?	<sp>nn<cr><lf>	Returns the GPIB Address
Asset_tag	16 char string	General purpose string for customer use.
Auxdisp<sp><n>, <s>	n, s	Sets the auxiliary display function where “n” is the auxiliary display to be set (1,2, or 3) and “func” is the function (none, peak, rate,units)
Auxdisp?<sp><n>	s	Returns the auxiliary display function specified by “n” for the active channel
Brightness	f	Brightness f Set screen brightness between 0 and 100%
Brightness?	<sp>n.nnnnnE+nn<cr><lf>	Read the screen brightness
Asset_tag?	<sp>ssssssss<cr><lf>	Return customer asset tag string
B?	<sp>n.nnnnnE+nn<cr><lf>	Returns the B channel pressure reading
BR?	<sp>n.nnnnnE+nn<cr><lf>	Returns the B channel rate.
Baro?	<sp>+n.nnnnnE+nn<cr><lf>	Returns reading from barometric sensor or “NO BAROMETER” if one isn’t installed
C?	<sp>n.nnnnnE+nn<cr><lf>	Returns the C channel pressure reading
CR?	<sp>n.nnnnnE+nn<cr><lf>	Returns the C channel rate
Calculate_as_found_linearity		Calculate linearity slopes and intercepts from true/actual pressures
Caldisable	YES,NO	Sets whether or not the ability to calibrate the sensors is disabled
Caldisable?	<sp>(YES or NO)<cr><lf>	Returns whether or not the ability to calibrate the sensors is disabled
Cal_Interval?	<sp>nnn<cr><lf>	Returns the calibration interval in days for the sensor on the active channel
Cerr	None	Clears the error queue
Certificate	<sp>CCCC...<cr><lf>	Set the certificate string for the sensor on the active channel
Certificate?	<sp>CCCC...<cr><lf>	Returns the certificate string for the sensor on the active channel
Chan	A, B, C, D	Sets the active channel
Chan?	<sp>X<cr><lf>	Returns the active channel

Precision Pressure Indicator CPG2500

Chanfunc	n, func<cr><lf>	Sets the auxiliary display function where “n” is the auxiliary display to be set (1,2, or 3) and “func” is the function (none, peak, rate, units)
Chanfunc? <n>	<sp>CCCC...<cr><lf>	Returns the auxiliary display function specified by “n” for the active channel
Cmdset	Mensor, SCPI	Activates remote command set for instrument emulation modes
Cmdset?	<sp><CCCC...<cr><lf>	Returns active command set identifier
D?	<sp>n.nnnne+nn<cr><lf>	Returns the D channel pressure reading
DR?	<sp>n.nnnne+nn<cr><lf>	Returns the D channel rate
Decpt?	<sp>n<cr><lf>	Returns the number of decimal points (see Resolution)
Default	None	Sets the default values
Deltafunc	A+B, A+C, B+C, A-B, A-C, B-A, B-C, C-A, C-B	Sets the delta to be the result of the specified function
Deltafunc?	<sp>CCC<cr><lf>	Returns the delta function
DHCP	ON or OFF	Reserved for DHCP setup
DHCP?	<sp>(YES or NO)<cr><lf>	Reserved for DHCP setup
DOC	mm/dd/yyyy	Sets the date of cal for the active channel’s sensor
DOC?	<sp>mm/dd/yyyy<cr><lf>	Returns the date of cal for the active channel’s sensor
DOM?	<sp>mm/dd/yyyy<cr><lf>	Returns the date of manufacture
Error?	<sp> text description <cr><lf>	Returns the next error in the error queue
Filter	OFF, LOW, NORMAL, HIGH	Sets the reading filter 0, 80%, 92%, 95%
Filter?	<sp> (filter)<cr><lf>	Returns the reading filter
Gasdensity	Value in lb/cuft, or “NITROGEN” or “DRYAIR”	Sets the head pressure gas density in lb/cuft. Only set for currently active channel. See alias command MEDIADENSITY
Gasdensity?	<sp>+n.nnnnnE+nn<cr><lf>	Gets the head pressure gas density in lb/cuft. Only set for currently active channel. See alias command MEDIADENSITY?
Gastemp	Value in degrees	Degrees in ∞F or ∞C depending on selected units category. See HEADUNITS? channel. See alias command MEDIATEMP

Gastemp?	<sp>+n.nnnnnE+nn<cr><lf>	Gets the head pressure gas temperature. Degrees in ∞F or ∞C depending on selected units category. See HEADUNITS? Only set for currently active channel. See alias command MEDIATEMP?
Gateway	nnn.nnn.nnn.nnn	Sets the Ethernet gateway address
Gateway?	<sp>nnn.nnn.nnn.nnn<cr><lf>	Gets the Ethernet gateway address
HeadChanAll	ON or OFF	When changing a head pressure correction setting, determines if the change applies to all channels, or only the currently active channel. When off, only applies to the active remote channel (see CHAN?). The head pressure correction setting include media density (see MEDIADENSITY?), media temperature (see MEDIATEMP?), and head height (see HEIGHT?).
HEADUNITS	METRIC/IMPERIAL/ENGLISH	Sets head pressure units category to metric of imperial
HEADUNITS?	METRIC or IMPERIAL	Sets head pressure units category
Height	Value in inches	Sets the head pressure height in inches
Height?	<sp>+n.nnnnnE+nn<cr><lf>	Gets the head pressure height in inches
Id?	<sp>SENSOR, CPG2500, ssssss, v.v.vv<cr><lf>	ssssss is the serial number, v.v.vv is the CPG2500 software version
IP	nnn.nnn.nnn.nnn	Sets the IP address of the instrument
IP?	<sp>nnn.nnn.nnn.nnn<cr><lf>	Returns the IP address of the instrument
Instmode	ssssssss	Set the instrument mode to Airdata, Ps/Pt Pressure, Ps/Pt Pressure, Ps/Pt, PsPt, Ps/Qc Pressure, PsQc, Ps, Pt, Qc, Altitude, Airspeed, or Pressure. Only valid for the CPA2501
Keylock	YES or NO	Locks or unlocks the entire touch screen
Keylock?	<sp>(YES or NO)<cr><lf>	Returns Yes or No

Precision Pressure Indicator CPG2500

LANGUAGE	XXXX	Set the displayed language. String to be sent may be ENGLISH, ENGLISH GB, ENGLISH CA, GERMAN, FRENCH, FRENCH CH, FRENCH CA, SPANISH, SPANISH LA, ITALIAN, POLISH, PORTUGUESE, PORTUGUESE BR, RUSSIAN, JAPANESE, CHINESE, KOREAN
LANGUAGE?	<sp>XXXX<cr><lf>	Returns the displayed language
LEAK_START		Starts leak test
LEAK_STOP		Abort leak test
LEAK_STATE?	(IDLE,RUNNING,COMPLETE)	Get the current state of the leak test. IDLE = test never run. RUNNING = currently running test. COMPLETE = test completed
LEAK_DWELL	Value in seconds	Set leak test dwell time
LEAK_DWELL?	<sp>+n.nnnnnE+nn<cr><lf>	Gets the leak test dwell time in seconds
LEAK_DELTA_LIMIT	Values in current engineering units	Set the leak test pass criteria for the allowable pressure change
LEAK_DELTA_LIMIT?	<sp>+n.nnnnnE+nn<cr><lf>	Gets the leak test delta limit in current engineering units
LEAK_INITIAL?	<sp>+n.nnnnnE+nn<cr><lf>	Get the leak test initial pressure in current engineering units
LEAK_FINAL?	<sp>+n.nnnnnE+nn<cr><lf>	Get the leak test ending pressure in current engineering units
LEAK_DELTA?	<sp>+n.nnnnnE+nn<cr><lf>	Returns the delta pressure of the final minus the initial pressure. This value is compared to the delta pass rate limit to determine if the test passed or failed.
Leak_pass_rate	f	Set the leak test pass rate limit
Leak_pass_rate?	<sp>+n.nnnnnE+nn<cr><lf>	Returns the leak test pass rate
LEAK_PASS?	(YES or NO)	Get the leak test pass results, which is YES when the delta pressure is less than the delta limit
List?	<sp>PRI,1<cr><lf>	Legacy query
Listcal?	<sp>PRI, {sn},1,{mmdyy}<cr><lf>	Returns the calibration date of the active sensor
Listrange?	<sp>PRI,1,min,max<cr><lf>	Returns the range of the active sensor
ListSN?	<sp>PRI,1,SSSSSSSS<cr><lf>	Returns the serial number of the sensor on the active channel
Localgravity	Value in ft/s^2	Sets the local gravity in feet/sec^2
Localgravity?	<sp>+n.nnnnnE+nn<cr><lf>	Returns the local gravity in feet/sec^2

Loudness	Integer 0 to 100	Set the speaker volume to ON or OFF. Greater than 50 sets on, less than or equal to 50 turns off
Loudness?	<sp>NNN<cr> <lf>	Returns the speaker volume, between 0 and 100
MACADDR?	<sp>XX-XX-XX-XX-XX-XX<cr><lf>	Returns MAC address for the instrument's ethernet interface.
MEDIADENSITY	Value, or ìNITROGENî or ìDRYAIRî	Set the media density. If value is sent, lb/cuft while in Imperial units, and kg/m ³ while in Metric units. See HEADUNITS? for units category.
MEDIADENSITY?	<sp>+n.nnnnnE+nn<cr><lf>	Returns the head pressure media density
MEDIATEMP	Value in degrees	Sets the head pressure gas temperature (only applicable while media type set to Pneumatic). Value returned in corresponding degrees ∞F or ∞C depending on selected units category. See HEADUNITS?
MEDIATEMP?	<sp>+n.nnnnnE+nn<cr><lf>	Gets the head pressure gas temperature (only applicable while media type set to Pneumatic). Value must be in corresponding degrees ∞F or ∞C depending on selected units category. See HEADUNITS?
Netmask	nnn.nnn.nnn.nnn	Sets the Ethernet network mask
Netmask?	<sp>nnn.nnn.nnn.nnn<cr><lf>	Gets the Ethernet network mask
OSVersion?	<sp>n.n<cr><lf>	Returns the operating system version
Outform	1 to 4 – see Section 7.9	Sets the output format
Outform?	<sp>X<cr><lf>	Returns the output format – see table below
Peakmax?	<sp>n.nnnnnE+nn<cr><lf>	Returns the maximum pressure since peakreset was sent
Peakmin?	<sp>n.nnnnnE+nn<cr><lf>	Returns the minimum pressure since peakreset was sent
Peakreset	None	Resets the peak values.
Port	nnnnn	Sets the Ethernet port of the instrument
Port?	<sp>nnnnn<cr><lf>	Returns the Ethernet port of the instrument
Ptype	Absolute or Gauge	Sets the instrument pressure type – emulation only works if the optional barometric sensor is installed
Ptype?	<sp>CCCC<cr><lf>	Returns “Absolute” or “Gauge” for the pressure type

Precision Pressure Indicator CPG2500

RangeMax?	<sp>n.nnnnnE+nn<cr><lf>	Returns the maximum range of the active transducer in the current units
RangeMin?	<sp>n.nnnnnE+nn<cr><lf>	Returns the minimum range of the active transducer in the current units
Rate?	<sp>n.nnnnnE+nn<cr><lf>	Returns the rate reading of the instrument in current units/current time unit (see: Runits)
Rdecpt?	<sp>n<cr><lf>	Returns the number of rate decimal points (see: Resolution)
Release?	15 char string. Ex: Release? Test stand 1 Returns: <sp>(YES or NO), CCC... CCC<cr><lf>	This command is used to release control of the instrument in a multiple computer environment. Yes if release is successful No if instrument is being controlled with another computer CCC... = name of controlling computer or AVAILABLE See: Acquire? and Unlock
Resolution	<n>	Sets the number of significant digits (see: decpt)
Resolution?	<sp>n<cr><lf>	Returns the number of significant digits (see: decpt)
Rfilter	Value in %	Sets the % of the rate filter
Rfilter?	<sp>n.nnnnnE+nn<cr><lf>	Returns the rate filter
Runits	SEC, MIN, HOUR, 3HOUR	Set the rate time units
Runits?	<sp>XXXX<cr><lf>	Returns the pressure per rate time units, i.e. BAR/SEC
Save_cal		Save calibration values
Save_linearity		Save linearity values
Sbaud	9600, 19200, 38400, 57600, 115200	Sets the serial baud rate
Sbaud?	<sp>XXXX<cr><lf>	Returns the serial baud data
Sdata	7 or 8	Sets the serial data bits
Sdata?	<sp>n<cr><lf>	Returns the serial data bits number
Sensorid?	<sp>Mensor,SN XXXXXX, VN.NN	Returns the active sensor's serial number and firmware version
Span	desired pressure or ?	Sets span on active transducer or for ?, clears previous value, must be > 50% FS and has a 1% limit. CALDIS-ABLE must be OFF/NO.
Span?	<sp>XXXXXXXX<cr><lf>	Returns span scale factor for active transducer
Sparity	Even, ODD, NONE	Sets the serial parity
Sparity?	<sp>CCCC<cr><lf>	Returns the serial parity
Sstop	1 or 2	Sets the serial stop bits

Sstop?	<sp>X<cr><lf>	Returns the serial stop bits
SUBUNITS?	<sp>XXXX<cr><lf>	Returns the instrument auxiliary display units in a text string
Tare	ON / OFF	Tares the reading to zero
Tare?	<sp> n.nnnnnE+nn <cr><lf>	Returns value of Tare
Transfer_factory_to_linearity		Copy factory linearity coefficients to customer
Units	units code or text in table below	Sets the instrument engineering units
Units?	<sp>CCCC<cr><lf>	Returns the instrument units in a text string
Unlock	None	Releases Acquire locks (see: Acquire?) or (see: Release?)
Window	Value in current units	Sets the exponential filter window for the active sensor
Window?	<sp>n.nnnnnE+nn <cr><lf>	Returns the exponential filter window for the active sensor
Zero	desired pressure or ?	Sets zero to set pressure or for ?, clears previous value. CALDISABLE must be OFF/NO
Zero?	<sp>n.nnnnnE+nn <cr><lf>	Returns zero offset for active transducer

Note:

Except for the engineering units selection, the numeric suffix selects the applicable channel/sensor:

- 1 = Channel A
- 2 = Channel B
- 3 = Channel C
- 4 = Channel D
- 5 = baro (if installed)

This numeric suffix always defaults to 1 and is designated by [C] (channel)

Precision Pressure Indicator CPG2500

7.9.1 Units Command Syntax for Measurement Units

n	Description	Output Format	Type
1	pounds per square inch	PSI	Imperial
2	inches of mercury @ 0°C	INHG	Imperial
3	inches of mercury @ 60°F	INHG	Imperial
4	inches of water @ 4°C	INH2O	Imperial
5	inches of water @ 20°C	INH2O	Imperial
6	inches of water @ 60°F	INH2O	Imperial
7	feet of water @ 4°C	FTH2O	Imperial
8	feet of water @ 20°C	FTH2O	Imperial
9	feet of water @ 60°F	FTH2O	Imperial
10	millitorr	MTORR	Metric
11	inches of sea water @ 0°C	INSW	Imperial
12	feet of sea water @ 0°C	FTSW	Imperial
13	atmospheres	ATM	Imperial
14	bars	BAR	Metric
15	millibars	MBAR	Metric
16	millimeters of water @ 4°C	MMH2O	Metric
17	centimeters of water @ 4°C	CMH2O	Metric
18	meters of water @ 4°C	MH2O	Metric
19	millimeters of mercury @ 0°C	MMHG	Metric
20	centimeters of mercury @ 0°C	CMHG	Metric
21	torr	TORR	Metric
22	kilopascals	KPA	Metric
23	pascals	PA	Metric
24	dynes per square centimeter	DY/CM ²	Metric
25	grams per square centimeter	G/CM ²	Metric
26	kilograms per square centimeter	KG/CM ²	Metric
27	meters of sea water @ 0°C	MSW	Metric
28	ounce per square inch	OSI	Imperial
29	pounds per square foot	PSF	Imperial
30	tons per square foot	TSF	Imperial
32	micron of mercury @ 0°C	mHG	Metric
33	tons per square inch	TSI	Imperial
34	hectapascals	HPA	Metric
36	megapascals	MPA	Metric
37	millimeters of water @ 20°C	MMH2O	Metric
38	centimeters of water @ 20C	CMH2O	Metric
39	meters of water @ 20°C	MH2O	Metric

7.9.2 CPG2500 Error Codes

Code	Serial Poll Byte	Description	Error String Returned
E00	00h	No errors	NO ERRORS
E05	45h	Parameter error	EGPIB PARAMETER ERROR: String that was sent
E07	47h	Syntax error	EGPIB SYNTAX ERROR: String that was sent

7.9.3 SCPI Commands and Queries

OUTPut		
	:CHANnel	Set the active channel to A, B, C, or BARO
	:CHANnel?	Returns the active channel
STATus		
	:OPERation	
	:CONDition?	Returns an integer value representing instrument status that can be decoded. Bit 0: Zeroing activ Bit 1: Control Setpoint has not been reached. Bit 2: Reserved 0. Bit 3: Reserved 0. Bit 5: Measuring. The instrument is actively measuring
MEASure		
	[:PRESsure][C]?	Returns the pressure from Channel [C]
	:TEMPerature[C]?	Returns the temperature from Channel [C]
	:RATE[C]?	Returns the rate/sec from Channel [C]
	:BAROmetric?	Returns the barometric pressure
CALibration		
	[:PRESsure][C]	
	:MODE?	Returns 1=calibrated or 0=not calibrated
	:DATE?	Returns date of cal "MM/DD/YY"
	:DATE <i,i,i>	Sets date of cal YYYY,MM,DD
	:ZERO?	Returns zero offset
	:ZERO <n>	Sets the zero offset
	:ZERO:INITiate	Ignored
SENSe		
	[:PRESsure][C]	
	:NAME?	Returns sensor name string
	:MODE?	Returns "ABSOLUTE" or "GAUGE"
	:MODE ABS GAUGE	Sets pressure type
	:ABS?	Returns native sensor type 0=GAUGE 1=ABSOLUTE
	:RESolution?	Returns resolution (float)
	:RANGe	
	[:UPPer]?	Returns maximum range
	:LOWer?	Returns minimum range
	:UNIT	
	[:NAME]?	Returns ASCII units (mixed case)

Precision Pressure Indicator CPG2500

:VALue?	Returns the units conversion factor
:REFerence	
[:HEIGHt] <n>	Sets the head pressure height in cm
:HEIGHt?	Returns the head pressure height in cm
:MODE?	Returns "OFF", "GAS", or "LIQUID"
:MODE OFF GAS LIQUID	Sets the head pressure mode
:MEDium<n>	Sets the medium density
:MEDium?	Returns medium
:ACTive <C>	Sets the active channel
ACTive?	Returns the active channel
SYSTem	
:CHANnel	Sets the active channel to A, B, C, or BARO
:CHANnel?	Returns the active channel
:DATE <i,i,i>	Not used, kept for backwards compatibility
:DATE?	Not used, does not cause an error, does not return a response
:TIME <i,i,i>	Not used, kept for backwards compatibility
:TIME?	Not used, does not cause an error, does not return a response
:ERRor[:NEXT]?	Returns error code, description
:KLOCK ON OFF 1 0	Sets the keylock state
:LANGuage?	Returns the active displayed language
:PRESet	Load known state values
:SAVe	No function (not needed)
:VERsion?	Returns SCPI version 1994.0
TEST	
:ELECTronic?	Returns "OK"
UNIT	
:[PREsSure] bar mbar Pa psi	Sets the pressure units
:[PREsSure]?	Returns the pressure units
:NAME<n>?	Returns the units string for units code <n>
:FACTor <n>?	Returns the units conversion for units code <n>
:INDEX <n>	Sets the index number.

:INDEX?	Returns the index number. index unit 0 bar 1 mbar 2 Pa 3 psi 4 atm 5 kp/cm2 6 lbf/ft2 7 kPa 8 cmH2O(4°C) 9 inH2O(4°C) 10 inH2O(60°F) 11 ftH2O(4°C) 12 µmHg(0°C) 13 mmHg(0°C) 14 cmHg(4°C) 15 inHg(0°C) 16 inHg(60°F) 17 -- 18 user 19 user 20 user
---------	--

7.9.4 SCPI Commands Error Messages and Error Codes

All remote commands sent to the CPG2500 are shown in the Trouble Shooting App, under the “Remote” button. If there is a syntax error, an error message will appear below the errant command. Local errors and remote command errors will appear under the “Error” button. Maximum of 100 errors are stored and can be retrieved.

7.9.5 GPIB Capability Codes

SH1	Full source handshake capability
AH1	Full acceptor handshake capability
T6	Talker with serial poll and unaddress if MLA
L4	Listener with unaddress if MTA
SR1	Full service request capability
L1	Full remote/local capability including LLO
PO	No parallel poll capability
DC1	Full device clear capability
DT1	Full device trigger capability
C0	No controller capability
E2	Tri-state outputs

7.9.6 Interface Functions

The CPG2500 responds to the following IEEE.488.2 interface functions:

- SRQ** Service Request: A service request is asserted whenever an error is encountered. When the bus controller issues a serial poll the error will be cleared. If the host IEEE board includes automatic serial polling capability, turn this feature off in order to view all errors.
- LLO** Local Lockout: The front panel keyboard of the CPG2500 may be locked by sending LLO or the command KEYLOCK ON.
- GET** Group Execute Trigger: When this message is received, the CPG2500 will save the current readings until the next time it is addressed as a talker.
- GTL** Go To Local: A GTL message will cause the CPG2500 to return to local operation and unlock the keyboard.
- DCL** Device Clear: When this message is received, the CPG2500 will clear all errors and buffers and remain in the Remote mode.
- SDC** Selected Device Clear: The effect is the same as DCL.
- EOI** End or Identify: May be used as a command or query terminator in the place of, or concurrent with, a terminating linefeed.

7.10 USB Software Upgrade

The instrument software can be upgraded to the most recent release by copying the instrument software from the Mensor website onto a USB device. The instrument software is device specific and the software for any other instrument apart from the CPG2500 is not accepted by the instrument. The user can then plug the USB device to the USB port on the front panel of the instrument for an easy upgrade. The instrument recognizes this device by displaying a USB icon on the top bar of the screen. The user can navigate to the Software upgrade menu by clicking on the USB icon. The software upgrade menu gives the user information on the current instrument software and the version of instrument software on the USB device (figure 7.10-A).

The user can load the instrument software from the USB to the instrument by clicking on the desired version and then clicking [] button. The status of the installation can be seen on right one fourth of the screen (figure 7.10-B).

Figure 7.10-C shows how to safely remove the USB drive.



Figure 7.10-A – Software Upgrade Menu



Figure 7.10-B – Loading Software



Figure 7.10-C – Remove USB Device

**Precision Pressure Indicator
CPG2500**

NOTES

8 Options

- Barometric Transducer Channel
- Barometric Reference (for gauge and absolute emulation)
- External Transducers (CPT9000, CPT6100 and CPT6180)
- External Sensor Package (rear plate with cable)
- Analog Output
- Rack Mount Kit
- Fittings
- Remote calibrations sleds (transducers, Barometric reference)

8.1 Barometer

The CPG2500 can be ordered as a single range Barometer. It is a very stable, absolute pressure sensor, used to accurately measure local atmospheric pressure. The only significant difference between a barometer and a regular transducer is that the transducer in a Barometer is calibrated from 8 to 17 psia and has an accuracy of 0.01% of reading. The channel setup information as explained in this manual also applies to the Barometer. It cannot, however, be used as a barometric reference for Gauge or Absolute emulation.

8.2 Barometric Reference (CPX-A-G1-3-J of CPX-A-G1-3-D)

The Barometric Reference Transducer is an absolute pressure sensor used to accurately measure local atmospheric pressure. This sensor is in a different housing compared to the regular transducers. It is removable by taking off the top cover of the chassis.

The CPG2500 uses the barometric pressure, measured by the barometric reference, for pressure mode emulation in the internal and external transducer channels. If a barometric reference is installed the Pressure Mode button in the measure application (main screen) will become active and, when pressed, will toggle between Absolute and Gauge mode (See section 6.4.1 Measure Application).

8.1.1 Gauge Pressure Emulation

In the Measure Application (main screen) an absolute transducer channel will indicate “Absolute” in the mode button (this is the default mode). When this button is pressed the button label will toggle to “Gauge” and have a lighter background color. The lighter background color is an indication that the channel is in emulation mode.

In the gauge emulation mode the atmospheric pressure reading from the barometric reference transducer is subtracted from the absolute pressure reading of the channel to emulate a gauge pressure.

The barometric reference sensor has six significant digits. If a very low pressure gauge sensor is active and is used in absolute emulation, the combined output may appear quite noisy because of the resolution of the barometric reference.

8.2.1 Absolute Pressure Emulation

In the Measure Application (main screen) a gauge transducer channel will indicate “Gauge” in the mode button (this is the default mode). When this button is pressed the button label will toggle to “Absolute” and have a lighter button background color. The lighter background color is an indication that the channel is in emulation mode.

In the absolute emulation mode the atmospheric pressure reading from the barometric reference transducer is added to the gauge pressure reading of the active channel to emulate an absolute pressure.

Precision Pressure Indicator CPG2500

8.2.2 Emulation Mode Accuracy

The accuracy in emulation mode is the combined accuracy of the transducer and the barometric reference.

8.2.3 Barometric Reference Calibration

The Barometric Reference Transducer can be calibrated in exactly the same manner as the other installed sensors as described in Section 10, Calibration.

8.2.4 Barometric Reference Specifications

Accuracy: 0.01% of reading. Uncertainties include all pressure effects, temperature effects over the calibrated range and calibration stability for 365 days after re-zeroing.

Pressure Range: The standard Barometric Reference Transducer is calibrated from 8 to 17 psia.

Resolution: 6 digits.

8.3 Delta Channel

The Delta Channel is a virtual channel that can display an arithmetic combination of the value of any two transducers that are installed. The Delta Channel is active when there is more than one transducer attached. When active, the Delta Channel can be chosen in the Frames App to be displayed in the Measure App and can be configured in the Transducer App as shown in figure 8.3. The Delta channel is enabled automatically when more than one transducer is connected.

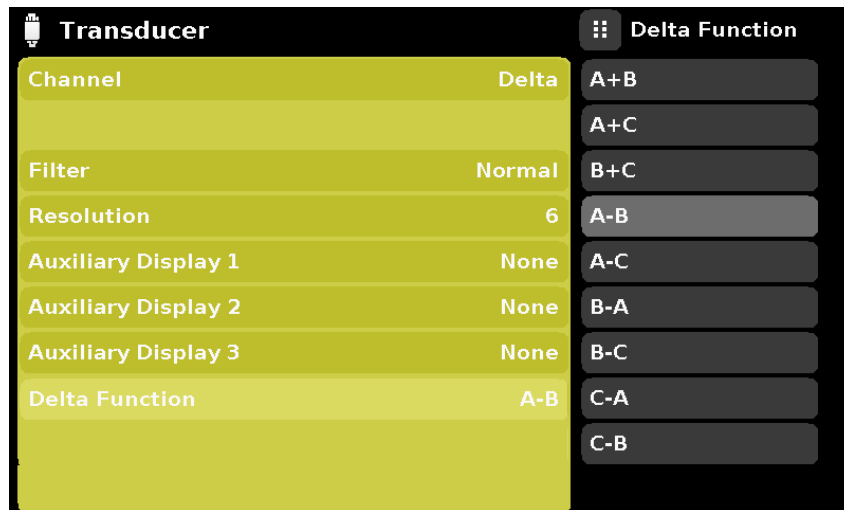

Figure 8.3 - Delta Channel Setup

8.4 External Transducers (CPT9000, CPT6100 and CPT6180)

The CPT6100 and CPT6180 are stand alone Digital Pressure Transducers that can be purchased separately and connected to the remote transducer port on the back of the CPG2500. The CPT6100 and CPT6180 have their own data sheets and manuals.

8.4.1 External Pressure Sensor Connection Cable

A shielded ribbon cable is required to connect an external transducer and can be supplied with or without an external Transducer. The CPT6100/6180 part number is: 4060090001. The CPT9000 part number is 0020543003.

8.5 Analog Output

The analog output option is available on all internal Transducers and on the CPT6100 external transducer. It can be configured at the time of manufacture to have voltage output that is directly proportional to the pressure input.

8.5.1 Specifications

Resolution:	0-1 VDC	1 part per 80,000 minimum
	0-5 VDC	1 part per 400,000 minimum
	0-10 VDC	1 part per 800,000 minimum

Update Rate: 150mS

Uncertainties:	0-1 VDC	0.010% FS
	0-5 VDC	0.010% FS
	0-10 VDC	0.010% FS

Minimum input impedance of the device measuring the analog output is 1 Megaohm.

8.6 Rack Mount Kit (CPX-A-G1-D or CPX-A-G1-R)

The CPG2500 can be supplied with a single or dual 19" rack mount kit.

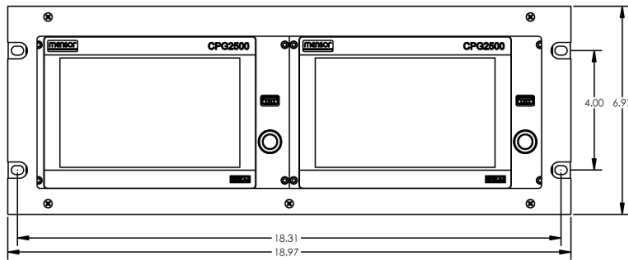

Dual Rack Mount

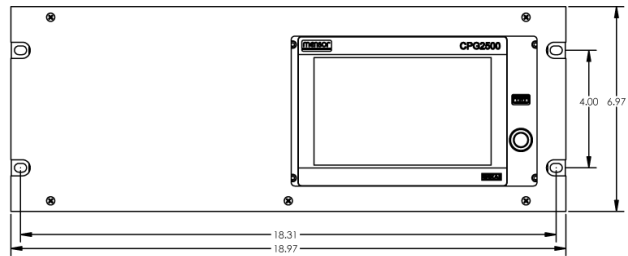

Single Rack Mount

8.7 Fittings (CPX-A-G1-M, CPX-A-G1-C, CPX-A-G1-B, CPX-A-G1-I, CPX-A-G1-E, CPX-A-G1-N, CPX-A-G1-A, CPX-A-G1-S, CPX-A-G1-F)

A variety of fittings are available at the time of order on sensors with a max range of $\leq 15,015$ psi (1,035 bar), or the CPG2500 can be ordered without adaptor fittings. Available fittings are shown in Section 9.2 - Spare Parts. An Autoclave F250C/ HIP HF4 is integral in all transducers with full scale ranges above 15,015 psi.

8.8 Remote Calibration (CPX-A-G1-4 or CPX-A-G1-5)

A remote calibration sled, power supply, cable and software are available to calibrate the optional barometric reference. A cable/power supply and software are available to remotely calibrate the internal transducers outside of the CPG2500. In both cases a PC with a serial connection is required. Both kits are supplied with an instruction manual.

Precision Pressure Indicator CPG2500

8.8.1 Remote Calibration Kit for Internal Transducers.

The cable / power supply used to calibrate the internal transducers remotely can be ordered as an option (pn # 0017245002). Calibration of each internal transducer can be performed remotely using the cable, a PC, and software provided.



Figure 8.9.1 - Remote Calibration Kit for Internal Transducer

8.8.2 Barometric Reference Calibration Sled

The CPG2500 Calibration Sled Kit is available to provide a way to calibrate the barometric reference remotely. Calibration of the Barometric Reference can be performed remotely using the Cal sled, a PC and the software provided.



Figure 8.9.2 - CPG2500 Barometric Reference Cal Sled Kit

8.8.3 External Calibration Procedures

To calibrate the internal transducers or the barometric reference remotely, use the same setup described in section 10 of this manual. The only difference is that the interface with the transducer is through the software provided and a PC, not directly through the instrument.

8.8.3.1 Transducer Removal

To remove the internal transducer, first remove the four slotted screws holding the transducer in the chassis, slide the transducer out of the back of the chassis and unplug the ribbon cable from the back of the transducer.



Figure 8.9.3.1 - Transducer Removal

8.8.3.2 Barometric Reference Removal

To remove the optional Barometric reference, first remove three screws holding the top panel of the chassis, then remove the top panel. This will reveal the barometer, Figure 8.9.3.2. The barometric reference can be removed by removing the attached hose, loosening the thumb screw, and lifting the barometric reference out of the chassis.



CAUTION: ESD protection is required when performing this operation.

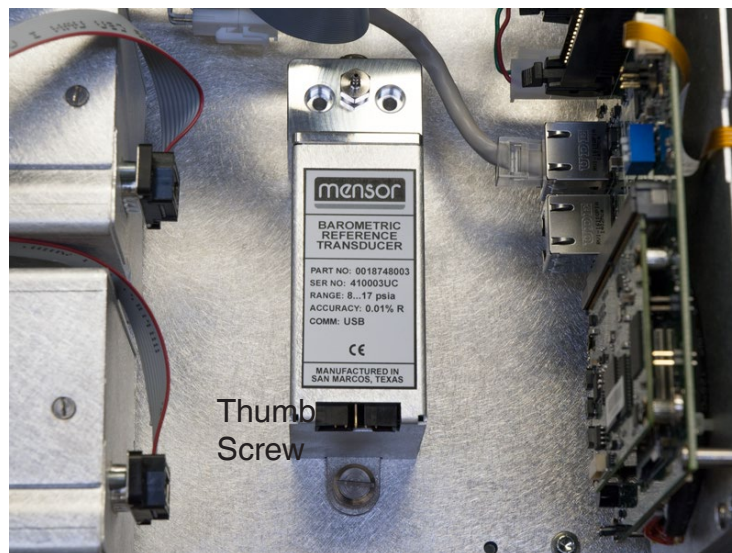

Figure 8.9.3.2 - Internal Barometric Reference

9 Maintenance

The CPG2500 was designed for maintenance-free operation. User maintenance is not recommended, beyond replacement of parts listed in Table 9.2. If you have questions not covered by this manual, call 1.800.984.4200 (USA only), or 1.512.396.4200 for assistance, or send an e-mail to tech.support@mentor.com.

9.1 Beyond the Warranty

Take advantage of Mentor’s expert product care. Mentor provides complete maintenance and calibration services, available for a nominal fee. Our service staff is knowledgeable in the innermost details of all of our instruments. We maintain units that are in operation in many different industries and in a variety of applications, and by users with a wide range of requirements. Many of these instruments have been in service for over twenty years, and continue to produce excellent results. Returning your instrument to Mentor for service benefits you in several ways:

- Our extensive knowledge of the instrument assures you that it will receive expert care.
- In many cases we can economically upgrade an older instrument to the latest improvements.
- Servicing our own instruments which are used in “real world” applications keeps us informed as to the most frequent services required. We use this knowledge in our continuing effort to design better and more robust instruments.

9.2 Spare Parts

Table 9.2 lists the spare parts for the CPG2500 that can be ordered from Mentor.

Table 9.2 - Spare Parts List

Part Description	Part Number	
Adaptor Fittings	Pressure ≤ 3000 psi	3000 psi ≤ pressure ≤ 6015 psi
6mm tube fittings (brass)	0018203043	
1/4” tube fittings (brass)	0018203045	
1/4” NPT female pipe thread (brass)	0018203005	
1/8” NPT female pipe thread (brass)	0018203001	
1/8 FBSPG female pipe thread (brass)	0018203018	
6mm tube fittings (Stainless)		0018203039
1/4” tube fittings (Stainless)		0018203027
1/4” NPT female pipe thread (Stainless)		0018203031
1/8” NPT female pipe thread (Stainless)		0018203035
1/8 FBSPG female pipe thread (Stainless)		0018203046
Kits/Manual	Part Number	
Kit - Rack Mount adapter, single unit	00192610001	
Kit - Rack Mount adapter, dual unit	0019261002	
Manual	0018908001	

10 Calibration

The CPG2500 automatically adjusts the pressure reading for the effects of temperature and non-linearity within the calibrated temperature range of 15-45°C. The process is referred to as dynamic compensation because each reading is so adjusted before it is output to the display or to a communication bus. Thus, a calibrated CPG2500 operated within its temperature band, and with proper zero and span adjustments, will provide accurate pressure measurements.

The CPG2500 should have the calibration verified periodically to insure stability. The recommended calibration cycle is one year or six months depending on the transducer range.

10.1 Environment

For maximum accuracy, allow the CPG2500 to warm up a minimum of 15 minutes in ambient temperature within the compensated range prior to a calibration. In addition, the instrument should be at rest on a stable platform that is free of excessive vibration and shock.

10.2 Pressure Standards

Mensor recommends the use of appropriately accurate primary pressure standards when calibrating this instrument. Such standards should be sufficient so that when the techniques of the ISO Guide to the Expression of Uncertainty in Measurement (GUM) are applied, the instrument meets its accuracy statements as required by ISO/IEC 17025:2017, or other applicable standards.

10.3 Media

The recommended calibration medium is dry nitrogen or clean dry instrument air. Hydraulic media can be used above 15 psi. A height variation between the standard and the CPG2500 can cause significant errors. A calculation should be made to compensate for this difference.

10.4 Setup

The following illustration for calibration setup shows a typical setup for either local or remote calibration for an absolute or gauge pressure instrument. The equipment shown in the rectangle is only necessary for absolute calibration. The PC is required only for performing a remote calibration.

The “Pressure Standard” is normally a deadweight test instrument, and the “Volume Controller” refers to a hand operated variable-volume pressure vernier device. A diaphragm type vacuum gauge is recommended over the gauge tube type of vacuum sensor for calibrating sub-atmospheric pressures. A vacuum pump with the capacity to generate 600 millitorr absolute is recommended.

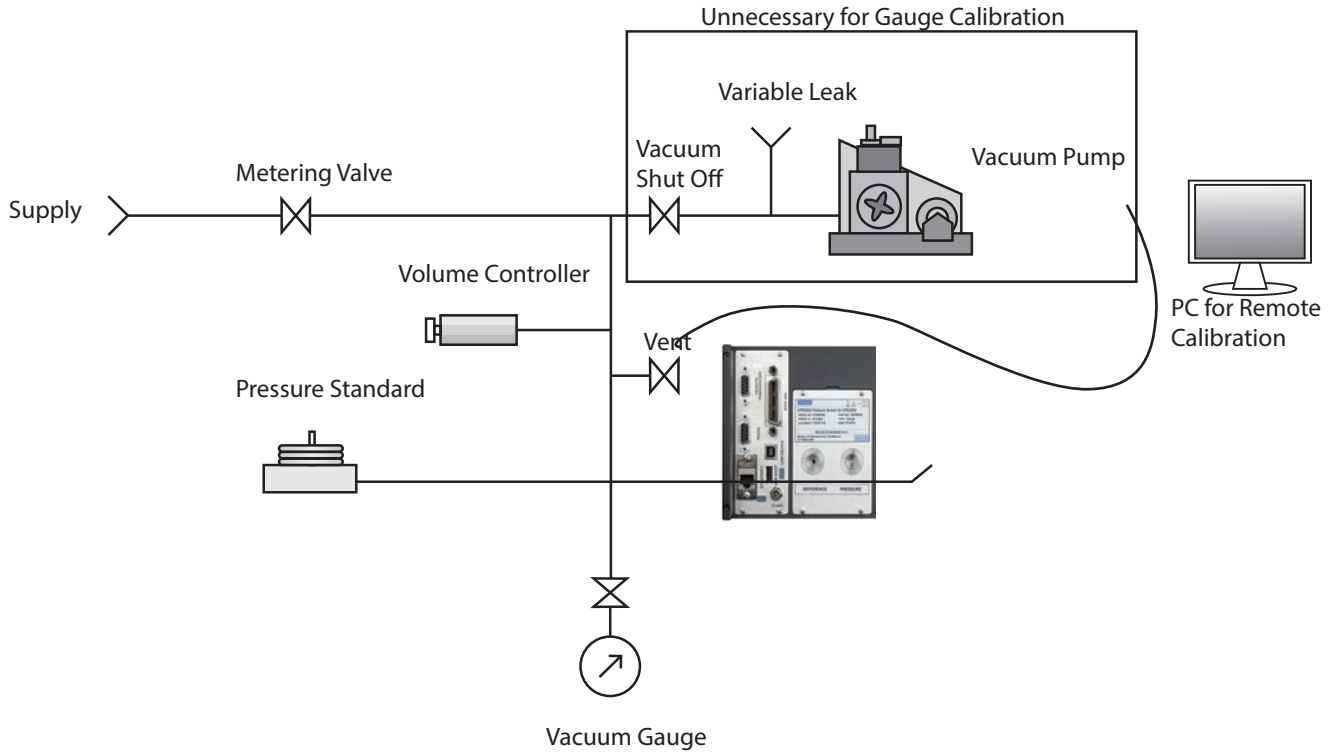

Figure 10.4 - Calibration Setup

When setting span while calibrating higher pressures (> 6,015 psia/401 bar) you must allow time (10 min. recommended) for temperature and pressure to stabilize.

10.5 Service Application



The Service application is a password protected area where calibration of all connected sensors can be accomplished. In addition, this is where the password for entering this area can be changed.

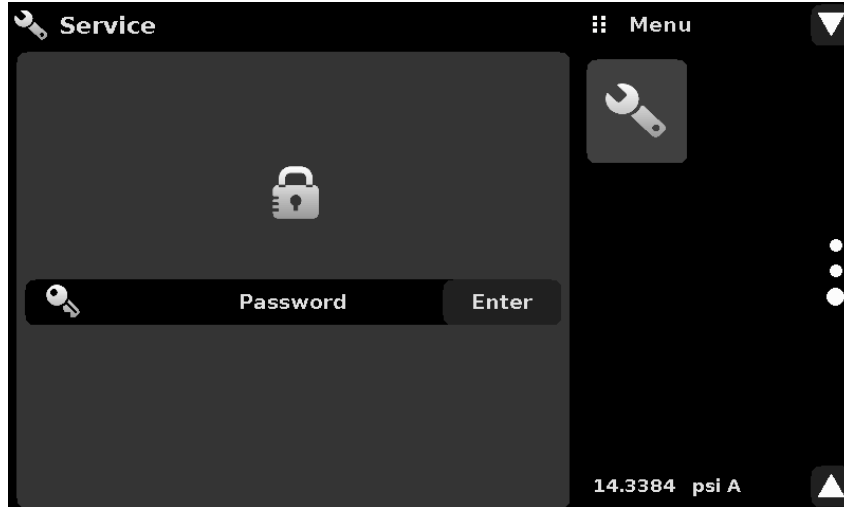



Figure 10.5-A - Service Application (locked)

Press the Enter button to show the numeric keypad to enter a password. This will unlock other applications. The Default password is 123456. Enter 123456 and press the check mark [] to unlock the Service Application.

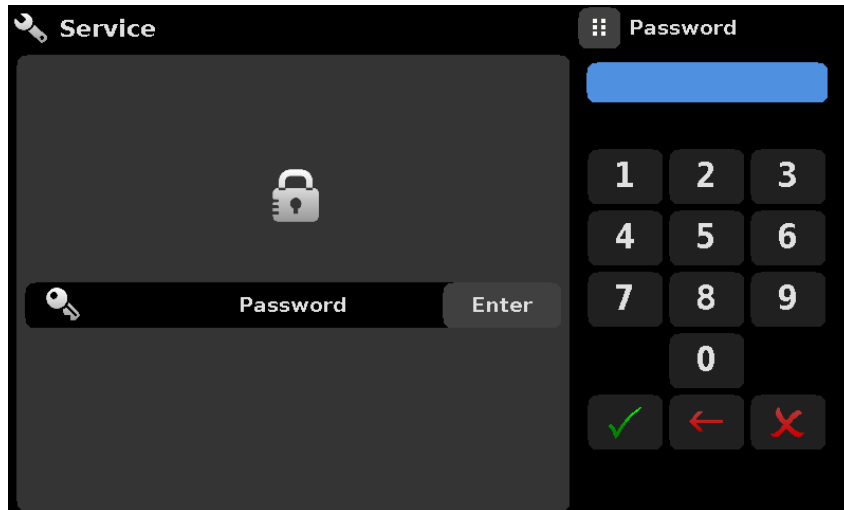

Figure 10.5-B - Service Application (Enter Password)



Note: The default Password is 123456. After entering this for the first time, the password can be changed.

10.5.1 Service Application (unlocked)

After the Password has been entered, the unlocked Service Application will appear (Figure 10.5.1). To re-lock this screen, press the Lock button.

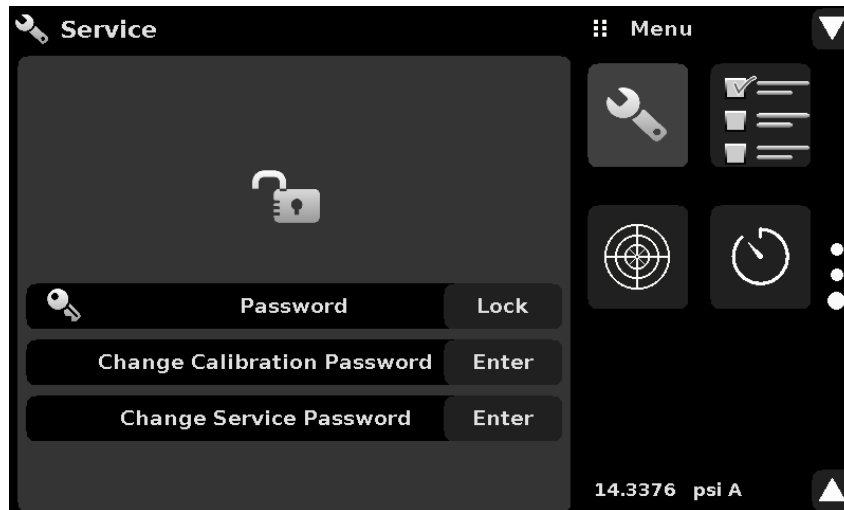



Figure 10.5.1 - Unlocked Service Application

From the unlocked Service Application, the Password can be changed by pressing the Enter button next to the Change Password label. This will open a keypad where a new password can be entered and accepted by pressing the Check Mark [].



Note: Please make note of a password change and save the new password in a secure location.

The Unlocked Service Application is the access point to all calibration screens described below.

10.6 Calibration Data

The Calibration Data Application is where the calibration data for each transducer is stored and amended. The Serial number (S/N), Zero offset (Zero) and Span offset (Span) can be seen in this screen. The date of calibration, the calibration interval and the certificate number can be entered by pressing the corresponding button, then saved by pressing the Check [] button. To revert back to the factory calibration, press the “Restore Factory Cal” button. To view the calibration data for each transducer press the “Channel” button at the top and choose a transducer from the resulting channel selection menu.

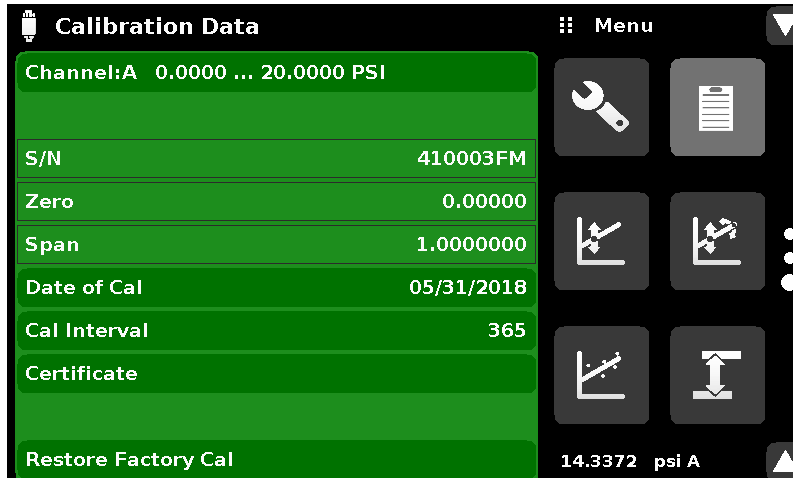
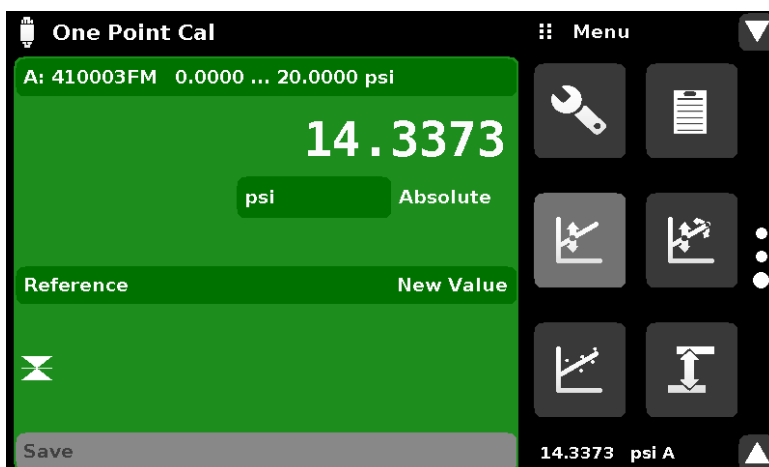

Figure 10.6 - Calibration Data

10.7 One Point Cal Application

A single point calibration (usually a zero point calibration) of each transducer installed can be accomplished in “One Point Cal” Application. The transducer channel is chosen by pressing the “Channel” button at the top of this screen, and then selecting from the list of installed transducer channels. For gauge pressure simply expose the reference and the pressure port of the transducer to atmospheric pressure and then press the “New Value” button and enter zero (0) using the keypad. For an absolute transducer apply a known reference pressure between 600 mTorr absolute and 20% of the selected transducer’s span to the pressure port of the transducer, press the “New Value” button and then enter the reference pressure (known true pressure) using the keypad. After a valid reference value is entered, the Save button will become active. If you want to save the value in the sensor, press Save to permanently save the adjustment to the transducer.



Notice the reference symbol [], this is a reference indication giving a constant reference point for the level of the internal sensor.

Figure 10.7 - One Point Cal Application

10.8 Two Point Cal Application



The Two Point Cal Application provides a place to adjust the Transducer Zero and Span (sometimes referred to as the offset and slope).

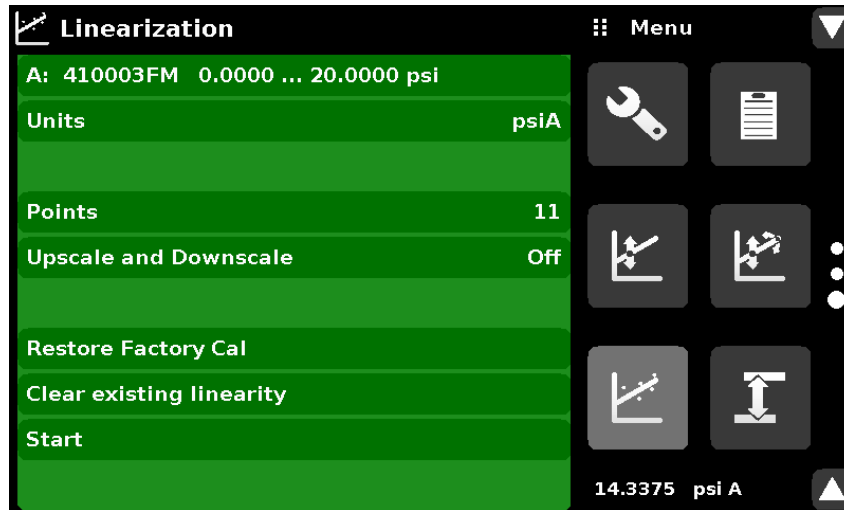



Figure 10.8 - Two Point Cal Application

Follow the steps below for a complete 2 Point Calibration:

Select a Transducer to calibrate by pressing the Channel button at the top of the screen.

To calibrate the “low Point”:

1. The pressure port of the transducer being calibrated should be supplied with a suitable, “low point” pressure (see section 5.4 Rear Panel for the port location).
2. For a gauge transducer, this low point pressure can be achieved by opening the pressure and reference ports to atmospheric pressure.
3. For an absolute transducer a suitable source of vacuum should be applied to the Pressure port along with a high accuracy vacuum standard or a pressure calibration standard can be connected to the Pressure port that can generate and measure a stable pressure value between 600 mTorr absolute and 20% of the active transducer’s span
4. When the pressure is stable, record the live reading shown on the Two Point Cal screen and enter this value as the “Low Reading” by pressing the Low Reading button and entering the number followed by the check mark []. Record the “true pressure” obtained from the reference standard and enter it as the “Low Reference” value in the same manner.

To calibrate the “High Point”:

5. The “High Point” Calibration is done in a similar way as the “Low Point”.
6. Supply a pressure to the Pressure Port of the Transducer being calibrated, using a pressure standard. This pressure should be as close as possible to the full scale value of the selected transducer or at least within 20% of that value.
7. After the pressure stabilizes, record live reading shown on the Two Point Cal screen and enter this value as the “High Reading” by pressing the High Reading button and entering the number followed by the check mark []. Record the “true pressure” obtained from the reference standard and enter it as the “High Reference” value in the same manner.

When the “High Reading” or “Low Reading” is selected, the main reading will become a button. When pressed the current reading will be used as a value.

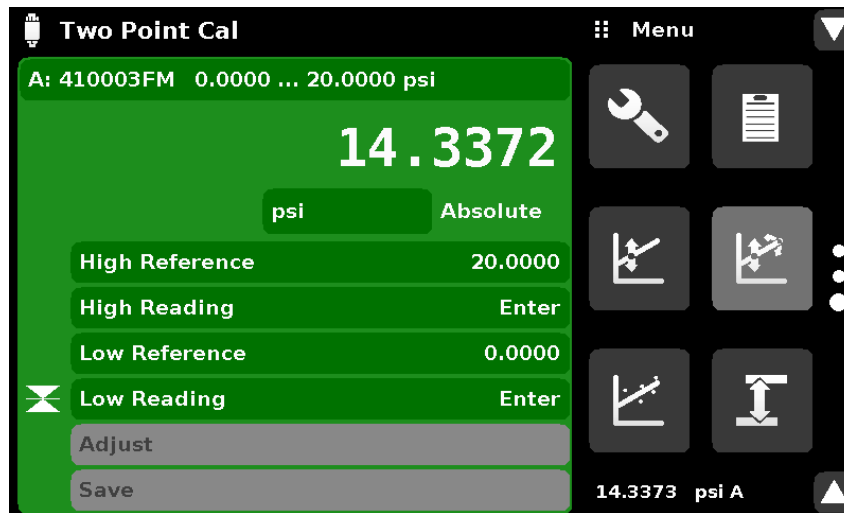

Figure 10.8-B “High Reading” and “Low Reading”

After all four values (High Reference, High Reading, Low reference, & Low reading) have been entered, the Adjust button will become active. Press the Adjust button to check and accept the calibration data then press the Save button. The instrument will then prompt with the question “Save Cal Data?”. Pressing the check mark [] in this screen will save the calibration to the memory of the sensor.

10.9 Linearization



The Linearization Application provides a place to record upscale and downscale calibration data and to linearize each transducer using that data. An “as found calibration” can be performed by connecting a suitable pressure standard to the Measure port of the CPG2500 channel being calibrated, and supplying between 3 and 11 pressure points across the complete range. The pressure points may be entered using both upscale and downscale pressure points, or only one direction (Figure 10.9-A). The “clear existing linearity” button erases the current linearization on the selected transducer. Pressing the “Start” button presents the next screen. The record of the pressures from the pressure standard and the corresponding reading from the instrument’s transducer can be recorded and transcribed into this screen called the Linearization Matrix shown in Figure 10.9-B. Linearization of each transducer can be performed from this screen by selecting each transducer range from the setup screen.

Precision Pressure Indicator CPG2500

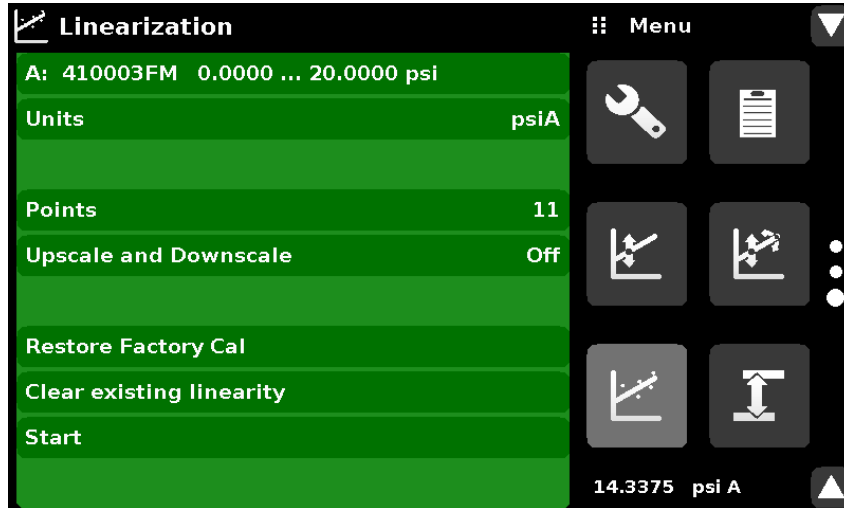

Figure 10.9-A - Linearization Application Setup



The Linearization Application automatically populates the screen with 10% increments from the low to high pressure corresponding to the range of the transducer selected. These values can be changed to reflect the values generated by the standard and the corresponding readings taken from the CPG2500. Each value from the standard can be entered under the reference column, corresponding Upscale and Downscale readings from the instrument can be entered in the “Upscale” and “Downscale” columns. To enter a value simply press the number and a key pad will appear (see Figure 10.9-B) where the number can be entered. Press the check mark [] to accept each value. The “Average” column automatically averages the upscale and downscale values.



Figure 10.9-B - Linearization Values

Figure 10.9-B shows some typical values that might be seen in a linearization calibration. In the bottom right hand corner of this screen is the Graph Icon [] that, when pressed, reveals a Linearization Error Graph (figure 10.9-C) that gives a visual representation of the errors associated with the values entered in the Linearization screen.

When one of the actual pressure readings in selected, the main reading will become a button. When pressed, the current reading will be used as the value.

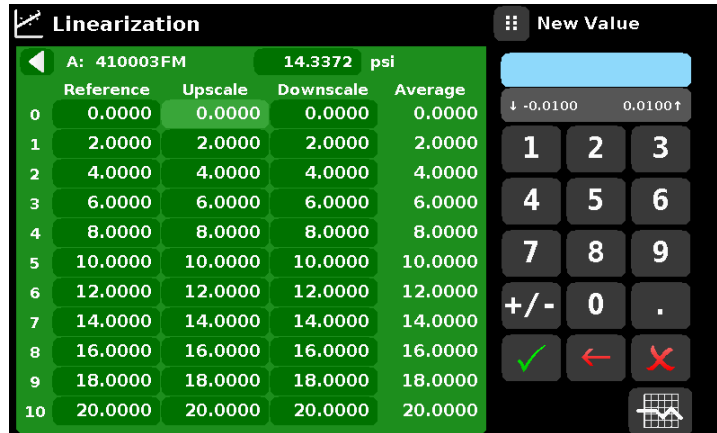



Figure 10.9-C Value Selected

This Linearization error graph shows a scaling that corresponds to the maximum error calculated from the data entered in the Linearization Matrix. It is a good indication of the overall error of the transducer, and will quickly reveal any gross data entry errors that have been made. To revert back to the Linearization Matrix press the Matrix Icon [].

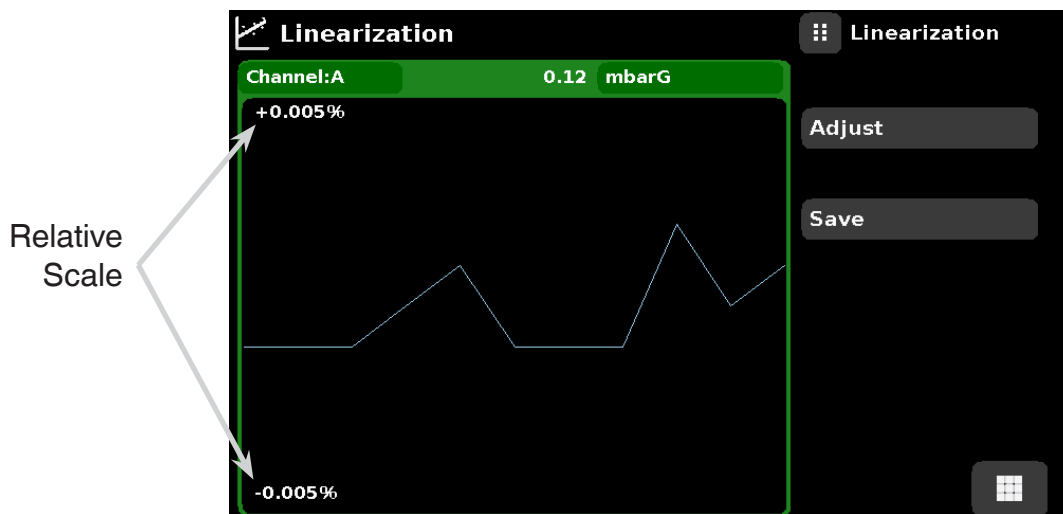

Figure 10.9-C - Linearization Error Graph

When satisfied that all values have been entered correctly, press the adjust button and then the save button to save the new calibration data in the transducer memory.



Note: After calibration is complete, return to the Calibration Data Application (Section 10.6) to record the certificate number, calibration interval and the date of calibration. Restoration to factory calibration can also be completed in this application.

10.10 Head Pressure

The Head Pressure Application provides an automated way to calculate the head pressure offset between a device being tested and the CPG2500 sensor, based on:

- Local Gravity
- Media: pneumatic or hydraulic
- Height: the difference between the device under test and the sensing element in the transducers (internal and external) in the CPG2500. Height difference = CPG2500-DUT
As an example, if the device under test (DUT) is 10 inches above the CPG2500, enter - 10 inches in the “Height” button.
- Media Density: the media density of the pressure media. Choices for pneumatic media are Nitrogen or Dry Air. For Hydraulic media a value may be entered.
- Media Temperature: Only applicable with pneumatic media.

The Head Pressure application is placed under the password protected area of the operator interface to safeguard against inadvertent activation. It is intended to be used to accurately measure the pressure at an external source that is at a different elevation from the CPG2500 transducer sensing that pressure. The four parameters are used to calculate the pressure that is a result of the different elevations. It should not be used when calibrating CPG2500 transducers. The Head height should be set at zero before calibrating the transducers of the CPG2500.



Notice

The Head Pressure should not be active when calibrating CPG2500 transducers. The Head height should be set at zero before calibrating the transducers of the CPG2500. Difference in height between the laboratory standard and the CPG2500 during calibration should be factored into the uncertainty analysis.

Figure 10.10-A shows the Head Pressure pneumatic screen. The height, media density (Nitrogen or dry air), media temperature and local gravity can be entered here based on the specific setup of the system.

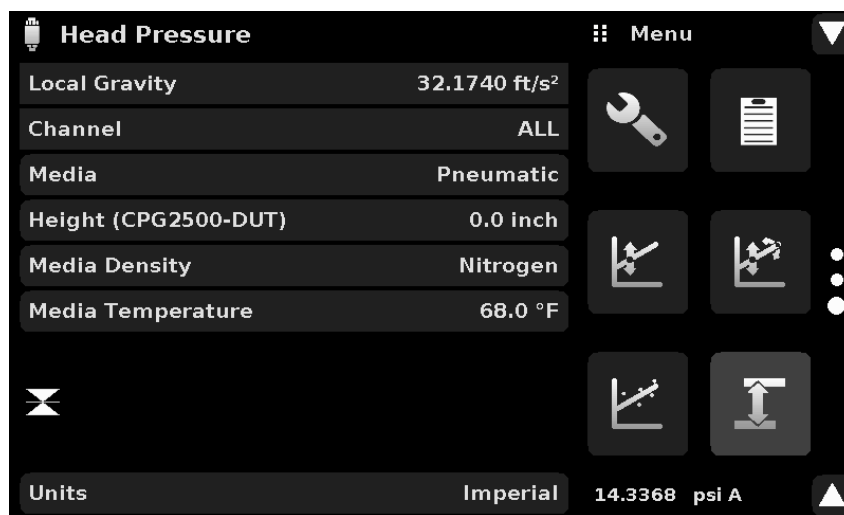

Figure 10.10-A - Head Pressure, Pneumatic

Precision Pressure Indicator CPG2500

The head pressure may be set individually for each channel. With the channel set to “All”, every channel installed in the CPG2500 will use the same head pressure correction values.

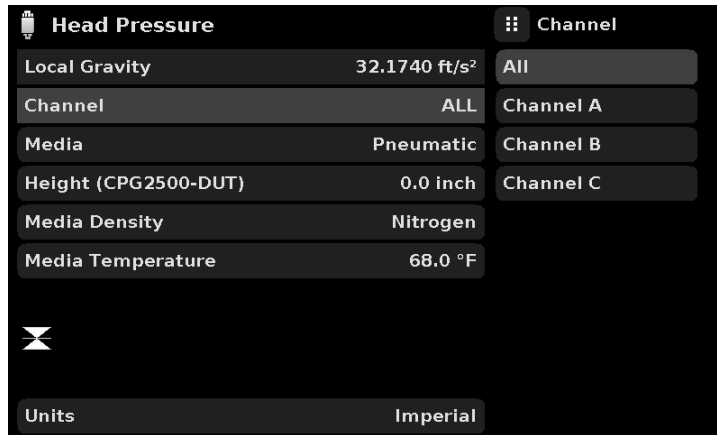

Figure 10.10-B Head Pressure Channel

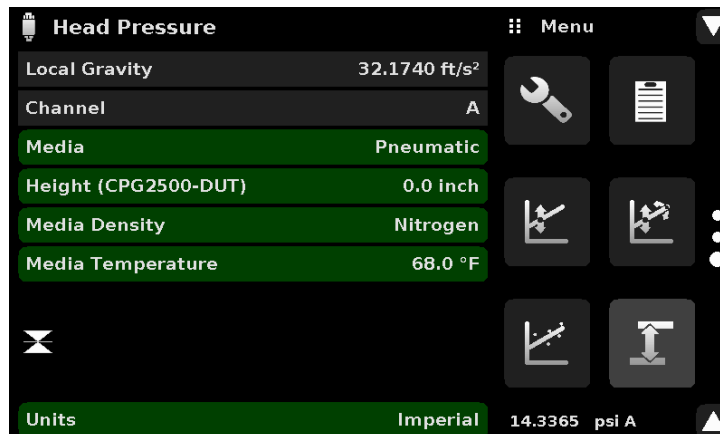

Figure 10.10-C Pressure values (Channel A)

Figure 10.10-D shows the Head Pressure hydraulic screen. The height, media density, media temperature and local gravity can be entered here based on the specific setup of the system

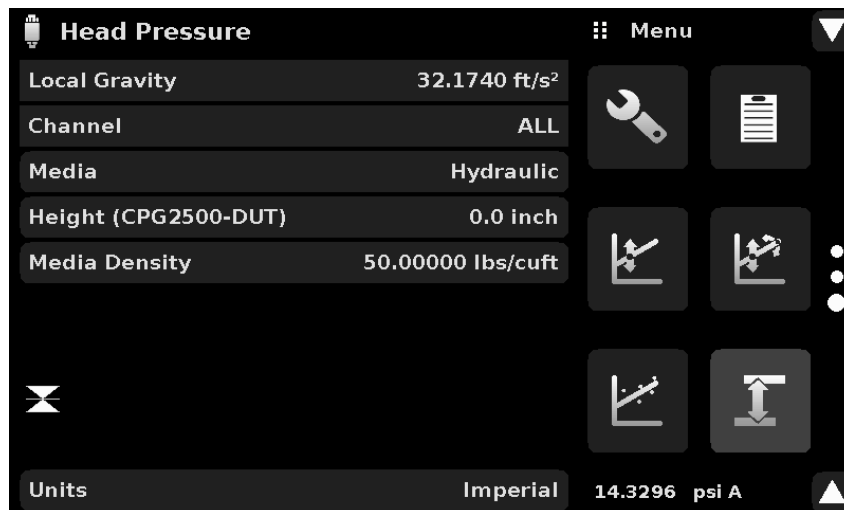

Figure 10.10-D - Head Pressure, Hydraulic

11 Appendix

Table 11.1 - Measurement Units (unitno)

Code	Description	Output Format
1	pounds per square inch	PSI
2	inches of mercury @ 0°C	inHg 0°C
3	inches of mercury @ 60°F	inHg 60°F
4	inches of water @ 4°C	inH2O 4°C
5	inches of water @ 20°C	inH2O 20°C
6	inches of water @ 60°F	inH2O 60°F
7	feet of water @ 4°C	ftH2O 4°C
8	feet of water @ 20°C	ftH2O 20°C
9	feet of water @ 60°F	ftH2O 60°F
10	millitorr	mTorr
11	inches of seawater @ 0°C 3.5% salinity	inSW
12	feet of seawater @ 0°C 3.5% salinity	ftSW
13	atmospheres	ATM
14	bars	Bar
15	millibars	mBar
16	millimeters of water @ 4°C	mmH2O 4°C
17	centimeters of water @ 4°C	cmH2O 4°C
18	meters of water @ 4°C	MH2O 4°C
19	millimeters of mercury @ 0°C	mmHg 0°C
20	centimeters of mercury @ 0°C	cmHg 0°C
21	torr	Torr
22	kilopascals	kPa
23	pascals	PA
24	dyne per square centimeter	Dy/cm2
25	grams per square centimeter	gm/cm2
26	kilograms per square centimeter	kg/cm2
27	meters of seawater @ 0°C 3.5% salinity	MSW
28	ounce per square inch	OSI
29	pounds per square foot	PSF
30	tons per square foot	TSF
31	percent of full scale	%FS
32	micron HG @ 0°C	μHg 0°C
33	ton per square inch	TSI
34	n/a	n/a
35	hectopascals	hPa
36	megapascals	MPa
37	millimeters of water @ 20°C	mmH2O 20°C
38	centimeter of water @ 20°C	cmH2O 20°C
39	meters of water @ 20°C	MH2O 20°C
n/a	User Units 1	User defined
n/a	User Units 2	User defined

Precision Pressure Indicator CPG2500

11.1 Conversion Factors, PSI

The values listed in the column “To convert from PSI” are the values imbedded in the instrument program. The values listed under “To convert to PSI” are internally calculated approximations based on the imbedded values.

Table 11.2 - Conversion Factors, PSI

Code	Pressure Unit	To convert from PSI	To convert to PSI
1	PSI	1	1
2	inHg 0°C	2.036020	0.4911544
3	inHg 60°F	2.041772	0.4897707
4	inH2O 4°C	27.68067	0.03612629
5	inH2O 20°C	27.72977	0.03606233
6	inH2O 60°F	27.70759	0.03609119
7	ftH2O 4°C	2.306726	0.4335149
8	ftH2O 20°C	2.310814	0.4327480
9	ftH2O 60°F	2.308966	0.4330943
10	mTorr	51715.08	0.00001933672
11	inSW 0°C 3.5% salinity	26.92334	0.03714250
12	ftSW 0°C 3.5% salinity	2.243611	0.445710
13	ATM	0.06804596	14.69595
14	Bar	0.06894757	14.50377
15	mBar	68.94757	0.01450377
16	mmH2O 4°C	703.0890	0.001422295
17	cmH2O 4°C	70.30890	0.01422295
18	MH2O 4°C	0.7030890	1.422295
19	mmHg 0°C	51.71508	0.01933672
20	cmHg 0°C	5.171508	0.1933672
21	Torr	51.71508	0.01933672
22	kPa	6.894757	0.1450377
23	PA	6894.757	0.0001450377
24	Dy/cm2	68947.57	0.00001450377
25	gm/cm2	70.30697	0.01422334
26	kg/cm2	0.07030697	14.22334
27	MSW 0°C 3.5% salinity	0.6838528	1.462303
28	OSI	16	0.0625
29	PSF	144	0.006944444
30	TSF	0.072	13.88889
31	%FS	(PSI / RANGE) x 100	(% FS x RANGE) / 100
32	μHg 0°C	51715.08	0.00001933672
33	TSI	0.0005	2000
35	hPa	68.94757	0.01450377
36	MPa	0.006894757	145.0377
37	mmH2O 20°C	704.336	0.001419777
38	cmH2O 20°C	70.4336	0.01419777
39	MH2O 20°C	0.704336	1.419777

11.2 Conversion Factors, Millitorr

The following table lists factors which should be used as multipliers when converting other pressure units to or from millitorr.

Table 11.3 - Conversion Factors, millitorr

Code	Pressure Unit	To convert from millitorr	To convert to millitorr
1	PSI	0.0001933672	51715.08
2	inHg 0°C	0.0003936995	25400.08909
3	inHg 60°F	0.0003948117	25328.53093
4	inH ₂ O 4°C	0.0005352534	1868.273977
5	inH ₂ O 20°C	0.0005362028	1864.966281
6	inH ₂ O 60°F	0.0005357739	1866.458778
7	ftH ₂ O 4°C	0.0004460451	22419.25773
8	ftH ₂ O 20°C	0.0004468356	22379.59744
9	ftH ₂ O 60°F	0.0004464783	22397.50637
10	mTorr	1.0	1.000000000
11	inSW 0°C 3.5% salinity	0.0005206091	1920.827359
12	ftSW 0°C 3.5% salinity	0.0004338408	23049.92831
13	ATM	0.00001315786	760002.2299
14	Bar	0.00001333220	750063.6259
15	mBar	0.001333220	750.0636259
16	mmH ₂ O 4°C	0.0135954	73.5540997
17	cmH ₂ O 4°C	0.001359544	735.5409971
18	MH ₂ O 4°C	0.00001359544	73554.09971
19	mmHg 0°C	0.001	1000.000000
20	cmHg 0°C	0.0001	10000.00000
21	Torr	0.001	1000.000000
22	kPa	0.0001333220	7500.636259
23	PA	0.1333220	7.500636259
24	Dy/cm ²	1.333220	0.750063626
25	gm/cm ²	0.001359506	735.561166
26	kg/cm ²	0.000001359506	735561.166
27	MSW 0°C 3.5% salinity	0.00001322347	75623.11663
28	OSI	0.0003093875	3232.1992
29	PSF	0.002784488	359.132477
30	TSF	0.000001392244	718265.0575
32	μHg 0°C	1.0	1.000000000
33	TSI	0.00000000966836	103430160.00
35	hPa	0.001333220	750.0636259
36	MPa	0.0000001333220	7500636.259
37	mmH ₂ O 20°C	0.01361955	73.42388114
38	cmH ₂ O 20°C	0.001361955	734.2388114
39	MH ₂ O 20°C	0.00001361955	73423.88114

11.3 Conversion Factors, Pascal

The following table lists factors which should be used as multipliers when converting other pressure units to or from Pascal.

11.4 - Conversion Factors, Pascal

Unit No.	Pressure Unit	To convert from Pascal	To convert to Pascal
1	PSI	1.450377E-04	6.894757E+03
2	inHg 0°C	2.952997E-04	3.386390E+03
3	inHg 60°F	2.961339E-04	3.376850E+03
4	inH2O 4°C	4.014741E-03	2.490820E+02
5	inH2O 20°C	4.021862E-03	2.486410E+02
6	inH2O 60°F	4.018645E-03	2.488400E+02
7	ftH2O 4°C	3.345622E-04	2.988980E+03
8	ftH2O 20°C	3.351551E-04	2.983692E+03
9	ftH2O 60°F	3.348871E-04	2.986080E+03
10	mTorr	7.500636E+00	1.333220E-01
11	inSW 0°C 3.5% sal	3.904899E-03	2.560885E+02
12	ftSW 0°C 3.5% sal	3.254082E-04	3.073062E+03
13	ATM	9.869230E-06	1.013250E+05
14	Bar	1.00000E-05	1.00000E+05
15	mBar	1.00000E-02	1.00000E+02
16	mmH2O 4°C	1.019744E-01	9.806378E+00
17	cmH2O 4°C	1.019744E-02	9.806378E+01
18	MH2O 4°C	1.019744E-04	9.806378E+03
19	mmHg 0°C	7.500636E-03	1.333220E+02
20	cmHg 0°C	7.500636E-04	1.333220E+03
21	Torr	7.500636E-03	1.333220E+02
22	kPa	1.00000E-03	1.00000E+03
23	PA	1.00000E+00	1.00000E+00
24	Dy/cm2	1.00000E+01	1.00000E-01
25	gm/cm2	1.019716E-02	9.806647E+01
26	kg/cm2	1.019716E-05	9.806647E+04
27	MSW 0°C 3.5% sal	9.918444E-05	1.008222E+04
28	OSI	2.320603E-03	4.309223E+02
29	PSF	2.088543E-02	4.788025E+01
30	TSF	1.044271E-05	9.576052E+04
32	µHg 0°C	7.500636E+00	1.333220E-01
33	TSI	7.251885E-08	1.378951E+07
35	hPa	1.00000E-02	1.00000E+02
36	MPa	1.00000E-06	1.00000E+06
37	mmH2O 20°C	1.021553E-01	9.789017E+00
38	cmH2O 20°C	1.021553E-02	9.789017E+01
39	MH2O 20°C	1.021553E-04	9.789017E+03



Mensor

201 Barnes Drive
San Marcos, Texas 78666
Tel: 512-396-4200
Website: www.mensor.com
Fax: 512-396-1820
Email: sales@mensor.com



WIKAI Alexander Wiegand SE & Co. KG
Alexander-Wiegand-Straße 30
D-63911 Klingenberg / Germany
Tel: (+49) 93 72/132-5015
Website: www.wika.de
Fax: (+49) 93 72/132-8767
Email: CTsales@wika.de