

G2, G3 ELECTRICAL TERMINATIONS AND WIRING

DEUTSCH DT SERIES DT04-3P

Pin No.	Voltage Output	4-20mA Output*	Mating Cable Color
1 (B)	Common	V -	Black
2 (C)	Output	V -	White
3 (A)	V +	V +	Red

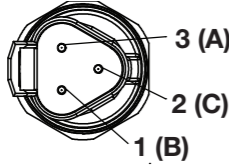

* Use either V- termination on G2 with 4-20mA output

DEUTSCH DTM SERIES DTM04-3P

Pin No.	Voltage Output	4-20mA Output*	Mating Cable Color
1	V +	V +	Red
2	Common	V -	Black
3	Output	V -	White

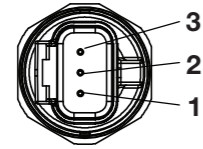

* Use either V- termination on G2 with 4-20mA output

SHIELDED CABLE, PVC JACKET, 24AWG LEADS

Wire Color	Voltage Output	4-20mA Output*
Red	V +	V +
Black	Common	V -
White	Output	V -
Bare**	Shield	Shield
	Drain Wire	Drain Wire

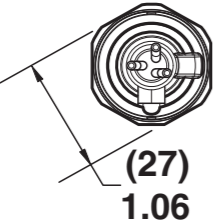

IP67 Ingress rating

* Use either V- termination on G2 with 4-20mA output

M12 ELECTRICAL TERMINATION FOR G2, G3 (EW), (EO), (E2), (E1)

Mates to optional Hirschmann connector Part 933 172-100 or equal

Pin No.	Voltage Output	4-20mA Output*	Mating Cable Color
1	V +	V +	Red
2	Case Grd.	Case Grd.	Green
3	Common	V -	Black
4	Output	V -	White

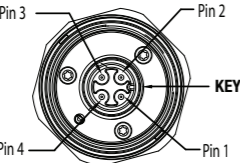

IP67 Ingress rating

G2, G3 ELECTRICAL TERMINATIONS AND WIRING

FLYING LEADS 18AWG

Wire Color	Voltage Output	4-20mA Output*
Red	V +	V +
Black	Common	V -
White	Output	V -

IP67 Ingress rating

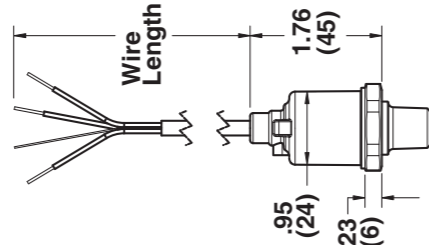

DIN 43650 FORM C (EN 175301-803-C) ELECTRICAL TERMINATION (DC), (N1), (N2), (N3), (N9)

Mates to Hirschmann P/N: GSSNR 300, Ashcroft P/N 300A126-01

Pin No.	Voltage Output	4-20mA Output*	Mating Cable Color
1	V +	V +	Red
2	Common	V -	Black
3	Output	V -	White

IP65 Ingress rating

Connection - PIN

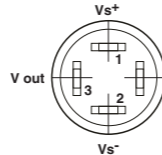

T2 ELECTRICAL TERMINATIONS AND WIRING

M12 ELECTRICAL TERMINATION FOR T2 (EW), (EO), (E2), (E1)

Mates to optional Hirschmann connector Part 933 172-100 or equal

Pin No.	Voltage Output	4-20mA Output*	Mating Cable Color
1	V +	V +	Red
2	Output	None	White
3	Case Grd.	Case Grd.	Green
4	Common	Common	Black

IP65 Ingress rating

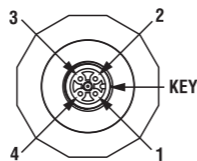

T2 ELECTRICAL TERMINATIONS AND WIRING

DIN 43650 FORM A (EN 175301-803-A) ELECTRICAL TERMINATION (DN), (DO), (D2), (D1)

Mates to optional Hirschmann connector GDM 3009 or equal

Pin No.	Voltage Output	4-20mA Output*	Mating Cable Color
1	V +	V +	Red
2	Common	Common	Black
3	Output	None	White
GND Case Gnd.	Case Gnd.	Green	

IP65 Ingress rating

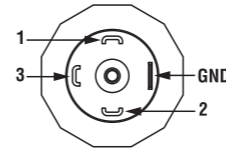

4-PIN BENDIX STYLE ELECTRICAL TERMINATION (B4), (H1), (L1), (P2)

Mates to optional Amphenol Bendix connector PT06A-8-4-SR or equal

Pin No.	Voltage Output	4-20mA Output*	Mating Cable Color
A	V +	V +	Red
B	Output	None	White
C	Case Gnd.	Case Gnd.	Green
D	Common	Common	Black

IP65 Ingress rating

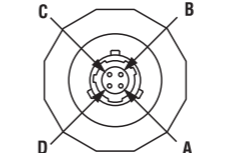

SHIELDED CABLE, PVC JACKET, 24 AWG LEADS, TERMINATION (F2), (P1)

Wire Color	Voltage Output	4-20mA Output
Red	V +	V +
White	Output	None
Black	Common	Common
Green	Case Gnd.	Case Gnd.
Bare**	Drain Wire	Drain Wire

IP65 Ingress rating

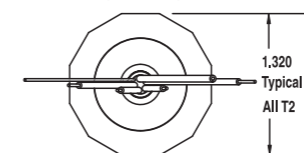

* Use either V- termination on G2 with 4-20mA output

** Where shielded wiring is being used; Connect the drain wire to the guard terminal on the read out device or measuring instrument if available. In all other cases connect to the ground of the power supply negative terminal.

ASHCROFT®

G2, G3 & T2 PRESSURE TRANSMITTER

INSTRUCTION SHEET



WARNING! READ BEFORE INSTALLATION



1. GENERAL:

A failure resulting in **injury** or **damage** may be caused by excessive overpressure, excessive vibration or pressure pulsation, excessive instrument temperature, corrosion of the pressure containing parts, or other misuse. Consult Ashcroft Inc., Stratford, Connecticut, USA before installing if there are any questions or concerns.

2. OVERPRESSURE:

Pressure spikes in excess of the rated overpressure capability of the transducer may cause **irreversible electrical and/or mechanical damage** to the pressure measuring and containing elements.

Fluid hammer and surges can destroy any pressure transducer and must always be avoided. A pressure snubber should be installed to eliminate the damaging hammer effects. Fluid hammer occurs when a liquid flow is suddenly stopped, as with quick closing solenoid valves. Surges occur when flow is suddenly begun, as when a pump is turned on at full power or a valve is quickly opened.

Liquid surges are particularly damaging to pressure transducers if the pipe is originally empty. To avoid damaging surges, fluid lines should remain full (if possible), pumps should be brought up to power slowly, and valves opened slowly. To avoid damage from both fluid hammer and surges, a surge chamber should be installed.

Symptoms of fluid hammer and surge's damaging effects:

- Pressure transducer exhibits an output at zero pressure (large zero offset).
- Pressure transducer output remains constant regardless of pressure
- In severe cases, there will be no output.

FREEZING:

Prohibit freezing of media in pressure port. Unit should be drained (mount in vertical position with electrical termination upward) to prevent possible overpressure damage from frozen media.

3. STATIC ELECTRICAL CHARGES:

Any electrical device may be susceptible to damage when exposed to static electrical charges. To avoid damage to the transducer observe the following:

- Ground the body of the transducer BEFORE making any electrical connections.

- When disconnecting, remove the ground LAST!

Note: The shield and drain wire in the cable (if supplied) is not connected to the transducer body, and is not a suitable ground.

DESCRIPTION

The Ashcroft Model G2, G3 and T2 pressure transducers are high performance instruments intended for use in industrial applications where the process media is compatible with the 17-4PH stainless steel sensor material and the 304 SS process connection.

The G3 utilizes 316L SS for both the sensor and process connection for use with a process media that requires all 316 SS wetted parts.

MECHANICAL INSTALLATION

Environmental

The G2, G3 and T2 transducers can be stored and used within the temperature limits of -40°C to 125°C (-40°F to 257°F). Ingress protection ratings of the units are dependent on the electrical termination specified. Refer to the wiring diagrams on the reverse for the IP rating of the unit which is being installed.

Mounting

The G2, G3 and T2 transducers require no special mounting hardware and can be mounted in any orientation with negligible position error. Although the units can withstand considerable vibration without damage or significant output effects, it is always good practice to mount the transducer where there is minimum vibration. For units with NPT type pressure fittings apply sealing tape or an equivalent sealant to the threads before installing. When installing or removing the unit apply a wrench to the hex wrench flats, located above the pressure fitting.

DO NOT tighten by using a pipe wrench on the housing. A 27mm (1 1/8") wrench can be used on the wrench flats of the hex. For G2, G3 models with detachable electrical connectors a 6 point deep socket can also be used to install the unit.

Electro-Magnetic Interference

The circuitry of the G2, G3 and T2 transducers is designed to minimize the effect of electromagnetic and radio frequency interference. To minimize susceptibility to noise, avoid running the termination wiring in a conduit which contains high current AC power cables.

Where possible avoid running the termination wiring near inductive equipment.

Field Adjustments

The G2, G3 and T2 transducers are precisely calibrated and temperature compensated at the factory to ensure long and stable performance. There are no field accessible adjustments on the G2 or T2 transducers.

ELECTRICAL INSTALLATION

Please refer to the reverse of this page for power supply requirements and for appropriate wiring protocol based on the particular output signal and electrical terminal.

G2, G3 & T2 ELECTRICAL INSTALLATION

Wiring Diagrams (see following pages for further detail)

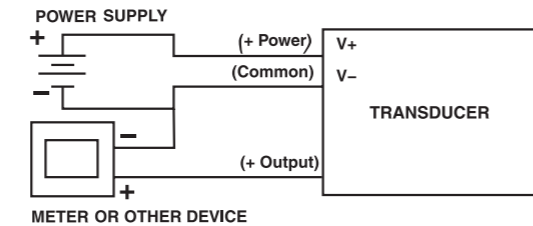
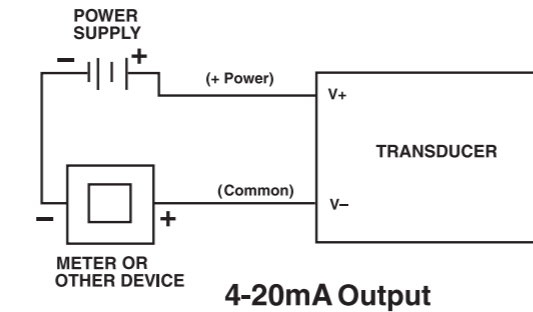

3-Wire Voltage Output

G2, G3 & T2 ELECTRICAL INSTALLATION (cont.)

Power Supply Requirements:

Output Signal	Min Supply	Max Supply
Ratiometric* (0.5V to 4.5V)	4.5Vdc	5.5Vdc
0-5Vdc	9Vdc	36Vdc
1-5Vdc	9Vdc	36Vdc
1-6Vdc	9Vdc	36Vdc
0-10V	14Vdc	36Vdc
0.5-4.5Vdc	9Vdc	36Vdc
4-20mA**	9Vdc	36Vdc

*0.5Vdc-4.5Vdc output is ratiometric to the nominal 5Vdc supply

**For transmitters with 4-20mA output signal, the minimum voltage at the terminals is 9Vdc. However, the minimum supply voltage should be calculated using the adjacent graph and formula.

Power Supply Voltage vs Loop Resistance

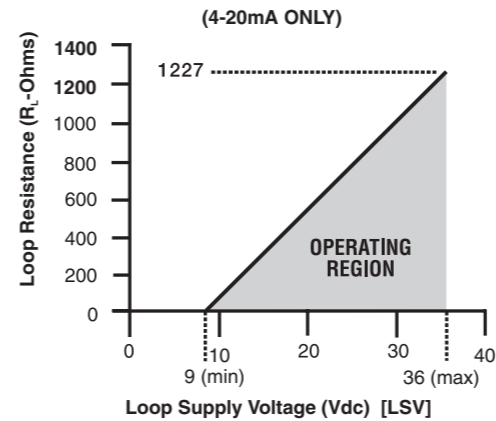

To determine minimum loop supply voltage:

$$LSV(\min) = 9(V) + [.022(A) * R_L]$$

Where:

LSV = Loop Supply Voltage (Vdc)

$R_L = R_S + R_W$ (ohms)

R_L = Loop Resistance (ohms)

R_S = Sense Resistance (ohms) [Measuring Instrument]

R_W = Wiring Resistance (ohms)

G2, G3 ELECTRICAL TERMINATIONS AND WIRING

3-PIN DELPHI (PACKARD) METRI-PACK 150 SERIES

Mates to Optional Metri-Pack connector 12065287

Pin No.	Voltage Output	4-20mA Output*	Mating Cable Color
A	Common	V-	Black
B	V+	V+	Red
C	Output	V-	White

IP67 Ingress rating

* Use either V- termination on G2 with 4-20mA output

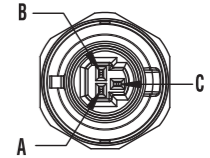

HIRSCHMANN G SERIES

Mates to Optional Hirschmann G4W1F connector, or equal

Pin No.	Voltage Output	4-20mA Output*	Mating Cable Color
1	V+	V+	Red
2	Common	V-	Black
3	Output	V-	White
4	Case Gnd.	Case Gnd.	Green

IP67 Ingress rating

* Use either V- termination on G2 with 4-20mA output

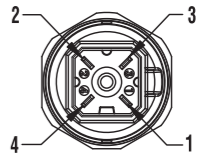

AMP SUPERSEAL

Pin No.	Voltage Output	4-20mA Output*	Mating Cable Color
1	Common	V-	Black
2	Output	V-	White
3	V+	V+	Red

* Use either V- termination on G2 with 4-20mA output

