

MRS1000

3D LiDAR sensors

SICK
Sensor Intelligence.



Described product

MRS1000

Manufacturer

SICK AG
Erwin-Sick-Str. 1
79183 Waldkirch
Germany

Legal information

This work is protected by copyright. Any rights derived from the copyright shall be reserved for SICK AG. Reproduction of this document or parts of this document is only permissible within the limits of the legal determination of Copyright Law. Any modification, abridgment or translation of this document is prohibited without the express written permission of SICK AG.

The trademarks stated in this document are the property of their respective owner.

© SICK AG. All rights reserved.

Original document

This document is an original document of SICK AG.



Contents

1	About this document.....	5
1.1	Information on the operating instructions.....	5
1.2	Explanation of symbols.....	5
1.3	Further information.....	6
2	Safety information.....	7
2.1	Intended use.....	7
2.2	Improper use.....	7
2.3	Internet protocol (IP) technology.....	7
2.4	Limitation of liability.....	8
2.5	Modifications and conversions.....	8
2.6	Requirements for skilled persons and operating personnel.....	8
2.7	Operational safety and particular hazards.....	9
3	Product description.....	10
3.1	Scope of delivery.....	10
3.2	Status indicators.....	10
3.3	Type code.....	10
3.4	Type label.....	11
3.5	Principle of operation.....	12
3.5.1	Measurement principle.....	12
3.5.2	Range finding.....	12
3.5.3	Direction measurement.....	13
3.5.4	Impact of object surfaces on the measurement.....	13
3.5.5	Scanning range.....	14
3.5.6	Object sizes.....	16
3.5.7	Multi-echo analysis.....	17
3.5.8	Filter.....	19
3.5.9	Multi-plane technology.....	24
3.5.10	Scan data output.....	24
3.5.11	Interlaced mode.....	25
3.5.12	RSSI values.....	27
3.5.13	Contamination indication.....	28
3.5.14	Calculation of the field size for mobile applications.....	28
4	Transport and storage.....	32
4.1	Transport.....	32
4.2	Unpacking.....	32
4.3	Transport inspection.....	32
4.4	Storage.....	32
5	Mounting.....	34
5.1	Mounting instructions.....	34
5.2	Mounting device.....	34

5.3	Mounting multiple devices.....	34
6	Electrical installation.....	36
6.1	Wiring instructions.....	36
6.2	Prerequisites for safe operation of the device.....	37
6.3	Connection diagram.....	39
6.4	Connection options.....	41
6.5	Connecting the device electrically.....	42
7	Operation.....	43
7.1	Operation with SOPAS ET.....	43
7.2	Operation with teach-in.....	48
8	Maintenance.....	49
8.1	Maintenance plan.....	49
8.2	Cleaning.....	49
9	Troubleshooting.....	50
9.1	General faults, warnings, and errors.....	50
9.2	Repairs.....	50
9.3	Returns.....	50
9.4	Disposal.....	50
10	Technical data.....	51
10.1	Features.....	51
10.2	Mechanics/electronics.....	53
10.3	Dimensional drawing.....	54
10.4	Performance.....	55
10.5	Interfaces.....	55
10.6	Ambient data.....	55
11	Accessories.....	56
12	Annex.....	57
12.1	EU declaration of conformity/Certificates.....	57
12.2	Licenses.....	57
12.3	Cybersecurity.....	57
12.4	Configuration without computer.....	57
12.4.1	Field evaluation.....	57
12.5	Configuration with computer.....	58
12.5.1	Output of measured values via terminal program.....	58
12.5.2	Measured value display and configuration via start window	60
12.5.3	Selecting the application.....	61
12.5.4	Field evaluation.....	61
12.5.5	Configuring interfaces.....	62
12.5.6	Some useful functions.....	62
12.5.7	Configuring the device.....	62

1 About this document

1.1 Information on the operating instructions

These operating instructions provide important information on how to use devices from SICK AG.

Prerequisites for safe work are:

- Compliance with all safety notes and handling instructions supplied.
- Compliance with local work safety regulations and general safety regulations for device applications

The operating instructions are intended to be used by qualified personnel and electrical specialists.



NOTE

Read these operating instructions carefully to familiarize yourself with the device and its functions before commencing any work.

The operating instructions are an integral part of the product. Store the instructions in the immediate vicinity of the device so they remain accessible to staff at all times. Should the device be passed on to a third party, these operating instructions should be handed over with it.

These operating instructions do not provide information on operating the machine or system in which the device is integrated. Information on this can be found in the operating instructions for the machine or system.

1.2 Explanation of symbols

Warnings and important information in this document are labeled with symbols. Signal words introduce the instructions and indicate the extent of the hazard. To avoid accidents, damage, and personal injury, always comply with the instructions and act carefully.



DANGER

... indicates a situation of imminent danger, which will lead to a fatality or serious injuries if not prevented.



WARNING

... indicates a potentially dangerous situation, which may lead to a fatality or serious injuries if not prevented.



CAUTION

... indicates a potentially dangerous situation, which may lead to minor/slight injuries if not prevented.



NOTICE

... indicates a potentially harmful situation, which may lead to material damage if not prevented.



NOTE

... highlights useful tips and recommendations as well as information for efficient and trouble-free operation.

1.3 Further information



NOTE

Further documentation for the device can be found on the online product page at:

- www.sick.com/MRS1000

Additional information is available there, depending on the product, e.g.:

- Model-specific online data sheets for device types, containing technical data, dimensional drawing, and specification diagrams
 - EU declaration of conformity and certificates of the product family
 - Dimensional drawings and 3D CAD dimension models of the device types in various electronic formats
 - Other publications related to the devices described here
 - Publications dealing with accessories
-

2 Safety information

2.1 Intended use

The MRS1000 3D LiDAR sensor features 4 scan planes and is designed for the following applications:

- Detection of objects during continuous output of measured data as required
- Field monitoring of freely defined areas with signaling of field breaches via switching outputs

It is suitable for applications which demand precise, non-contact optical measuring contours and dimensioning.

Typical areas of application include property/building protection, access monitoring, and collision protection.

SICK AG assumes no liability for losses or damage arising from the use of the product, either directly or indirectly. This applies in particular to use of the product that does not conform to its intended purpose and is not described in this documentation.

2.2 Improper use

Any use outside of the stated areas, in particular use outside of the technical specifications and the requirements for intended use, will be deemed to be incorrect use.

- The device does not constitute a safety component in accordance with the respective applicable safety standards for machines.
- The device must not be used in explosion-hazardous areas, in corrosive environments or under extreme environmental conditions.
- Any use of accessories not specifically approved by SICK AG is at your own risk.



WARNING

Danger due to improper use!

Any improper use can result in dangerous situations.

Therefore, observe the following information:

- Product should be used only in accordance with its intended use.
- All information in these operating instructions must be strictly observed.
- Shut down the product immediately in case of damage.

2.3 Internet protocol (IP) technology



NOTE

SICK uses standard IP technology in its products. The emphasis is placed on availability of products and services.

SICK always assumes the following prerequisites:

- The customer ensures the integrity and confidentiality of the data and rights affected by its own use of the aforementioned products.
- In all cases, the customer implements the appropriate security measures, such as network separation, firewalls, virus protection, and patch management.

2.4 Limitation of liability

Relevant standards and regulations, the latest technological developments, and our many years of knowledge and experience have all been taken into account when compiling the data and information contained in these operating instructions. The manufacturer accepts no liability for damage caused by:

- Non-adherence to the product documentation (e.g., operating instructions)
- Incorrect use
- Use of untrained staff
- Unauthorized conversions or repair
- Technical modifications
- Use of unauthorized spare parts, consumables, and accessories

With special variants, where optional extras have been ordered, or owing to the latest technical changes, the actual scope of delivery may vary from the features and illustrations shown here.

2.5 Modifications and conversions



NOTICE

Modifications and conversions to the device may result in unforeseeable dangers.

Interrupting or modifying the device or SICK software will invalidate any warranty claims against SICK AG. This applies in particular to opening the housing, even as part of mounting and electrical installation.

2.6 Requirements for skilled persons and operating personnel



WARNING

Risk of injury due to insufficient training.

Improper handling of the device may result in considerable personal injury and material damage.

- All work must only ever be carried out by the stipulated persons.

This product documentation refers to the following qualification requirements for the various activities associated with the device:

- **Instructed personnel** have been briefed by the operator about the tasks assigned to them and about potential dangers arising from improper action.
- **Skilled personnel** have the specialist training, skills, and experience, as well as knowledge of the relevant regulations, to be able to perform tasks delegated to them and to detect and avoid any potential dangers independently.
- **Electricians** have the specialist training, skills, and experience, as well as knowledge of the relevant standards and provisions, to be able to carry out work on electrical systems and to detect and avoid any potential dangers independently. The electrician must comply with the provisions of the locally applicable work safety regulation.

The following qualifications are required for various activities:

Table 1: Activities and technical requirements

Activities	Qualification
Mounting, maintenance	<ul style="list-style-type: none"> ■ Basic practical technical training ■ Knowledge of the current safety regulations in the workplace

Activities	Qualification
Electrical installation, device replacement	<ul style="list-style-type: none"> ■ Practical electrical training ■ Knowledge of current electrical safety regulations ■ Knowledge of the operation and control of the devices in their particular application
Commissioning, configuration	<ul style="list-style-type: none"> ■ Basic knowledge of the computer operating system used ■ Basic knowledge of the design and setup of the described connections and interfaces ■ Basic knowledge of data transmission
Operation of the device for the particular application	<ul style="list-style-type: none"> ■ Knowledge of the operation and control of the devices in their particular application ■ Knowledge of the software and hardware environment for the particular application

2.7 Operational safety and particular hazards

Please observe the safety notes and the warnings listed here and in other chapters of this product documentation to reduce the possibility of risks to health and avoid dangerous situations.



CAUTION

Optical radiation: Laser class 1

The accessible radiation does not pose a danger when viewed directly for up to 100 seconds. It may pose a danger to the eyes and skin in the event of incorrect use.

- Do not open the housing. Opening the housing may increase the level of risk.
- Current national regulations regarding laser protection must be observed.

Caution – Use of controls or adjustments or performance of procedures other than those specified herein may result in hazardous radiation exposure.



WARNING

Electrical voltage!

Electrical voltage can cause severe injury or death.

- Work on electrical systems must only be performed by qualified electricians.
- The power supply must be disconnected when attaching and detaching electrical connections.
- The product must only be connected to a voltage supply as set out in the requirements in the operating instructions.
- National and regional regulations must be complied with.
- Safety requirements relating to work on electrical systems must be complied with.



WARNING

Risk of injury and damage caused by potential equalization currents!

Improper grounding can lead to dangerous equipotential bonding currents, which may in turn lead to dangerous voltages on metallic surfaces, such as the housing. Electrical voltage can cause severe injury or death.

- Work on electrical systems must only be performed by qualified electricians.
- Follow the notes in the operating instructions.
- Install the grounding for the product and the system in accordance with national and regional regulations.

3 Product description

3.1 Scope of delivery

The delivery of the device includes the following components:

Table 2: Scope of delivery

Item	Component	Comments
1	Device in the version ordered	Depending on version Without connecting cables and brackets
1	Set of protective caps for electrical connections	Attached to the connections
1	Printed safety notes, multilingual	Quick guide and general safety notes

3.2 Status indicators

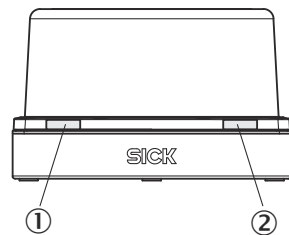

Figure 1: Status indicators

- ① LED1
- ② LED2

LED1 (color)	LED2 (color)	Description
● (Red)	● (Red)	Start-up, parameterization, firmware update, correctable error
-	-	Off
● (Green)	● (Yellow)	Field breached
● (Green)	● (Green)	Field free
⦿ (Red)	⦿ (Red)	Fatal error
● (Green)	● (Green)	On / Ready for operation
⦿ (Green)	⦿ (Green)	Standby
● (Green)	⦿ (Yellow)	Restart after time; input
⦿ (Yellow)	● (Green)	Contamination warning
⦿ (Yellow)	⦿ (Red)	Contamination error
⦿ (Yellow)	⦿ (Yellow)	EasyTeach / teach-in
⦿ (Green)	⦿ (Red)	Alignment mode
● (Green) ● (Yellow) ● (Red)	● (Green) ● (Yellow) ● (Red)	Identifying the device

● = illuminated; ⦿ = flashing

3.3 Type code

The devices of the MRS1000 product family are arranged according to the following type code:

MRS	a	b	cc	d	-	e	f	g	h	i	j
1	2	3	4	5	-	6	7	8	9	10	11

Position	Description	Characteristic
1	Device name type	MRS: Multilayer Range Sensor
2	Device type	1: MRS1000
3	Version (10% range & field of view (FOV))	1: 16m @10%, FOV 275°
4	Module (sender and receiver units (SRU))	04: 4 SEE (-2.5°; 0°; 2.5°; 5°)
5	Application	C: Combined (detection & ranging)
-		
6	Housing version	0: IP65 enclosure rating 1: IP67 enclosure rating 9: Special version
7	Connection	1: Rotatable connector, 3 x M12 9: Special version
8	Version	1: Standard 9: Special version
9	Laser type	1: Laser class 1, infrared
10	Motor frequency	1: 12.5 Hz
11	Color tone / label	0: blue (RAL 5012) 1: gray (RAL 7042)



NOTE

Not all combinations are possible according to the type code. The available device variants can be found online at:

- www.sick.com/MRS1000

3.4 Type label

The type label gives information for identification of the sensor.

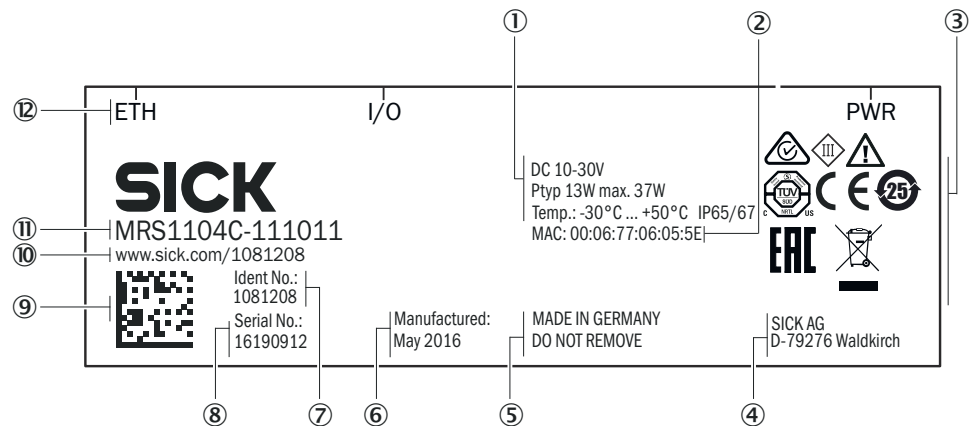

Figure 2: MRS1000 type label (example)

- ① Voltage supply, typical power, max. power, operating temperature, enclosure rating
- ② MAC address
- ③ Conformity mark/certification mark, symbol: Observe the operating instructions!
- ④ Manufacturer

- ⑤ Production location, note: Do not remove type label
- ⑥ Production date
- ⑦ Part number
- ⑧ Serial number
- ⑨ DataMatrix code with product data and link to product page
- ⑩ Web address of product page
- ⑪ Type code
- ⑫ Labeling of connections

3.5 Principle of operation

3.5.1 Measurement principle

The device is an opto-electronic LiDAR sensor that scans the outline of its surroundings with the help of laser beams without making contact. The device measures its surroundings in two-dimensional polar coordinates, relative to its measurement origin. This is marked by a circular indentation in the center of the optics cover. If a laser beam strikes an object, the position of that object is determined in terms of distance and angle.

With the MRS1000, this is carried out in 4 spread-out scan planes (layers 1 to 4).

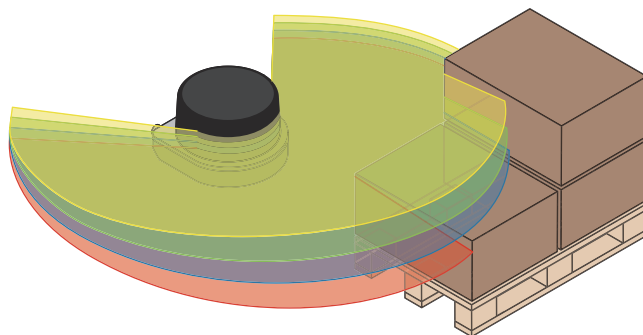
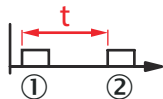

Figure 3: LiDAR sensor with 4 scan planes

3.5.2 Range finding

The device emits beams pulsed by a laser diode. If the laser beam is reflected by an object, the reflected beam is received by the sensor.

The distance to the object is calculated on the basis of the time that the pulsed light beam requires to be reflected and received by the sensor.



- ① Send pulse
- ② Receive pulse

The device uses SICK's own HDDM+ (High Definition Distance Measurement plus) technology. With this measurement process, a measured value is formed statistical evaluation of multiple single pulses. The multi-pulse feature of HDDM+ evaluates up to 165,000 echoes per second with every scan. Every single HDDM+ measured value output therefore provides even more information because it is not just composed of

a single time-of-flight measurement, but includes evaluated information from numerous pulses. In this process, the digitized echoes are compiled into data packages which overlap during evaluation. This guarantees a significantly more stable time and distance measurement.

3.5.3 Direction measurement

The laser beams are emitted using internally rotating sender-receiver units (SRUs) and scan the surroundings orbitally. The received measured values are assigned to the associated angular cut and thus to the direction.

3.5.4 Impact of object surfaces on the measurement

The received signal from a perfectly diffuse reflection from a white surface (diffuse Lambertian reflector) corresponds to a remission of 100%. By this definition, surfaces that reflect the light in bundles (specular surfaces, reflectors) have remissions of over 100%.

Reflection

Most surfaces produce a diffuse reflection of the laser beam in all directions. The structure (smooth or rough), shape (flat or curved), and color (light or dark) of the surface determine how well the laser beam is reflected.

On very rough surfaces, a large proportion of the energy is lost due to absorption. Curved surfaces produce a higher diffusion. Dark surfaces reflect the laser beam worse than light ones (brilliant white plaster reflects approx. 100% of the light, while black foam rubber reflects approx. 2.4%). The aforementioned surface characteristics can reduce the scanning range of the device, in particular for surfaces with low remission values.

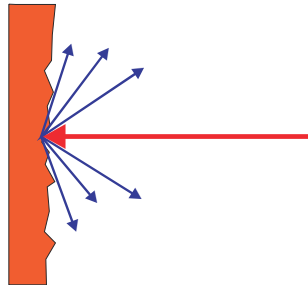

Figure 4: Reflection of light on the surface of the object

Angle of reflection

The angle of reflection corresponds to the angle of incidence. If the laser beam hits a surface at right angles, the energy is optimally reflected. If the laser beam hits a surface at an oblique angle, energy and range are lost accordingly.

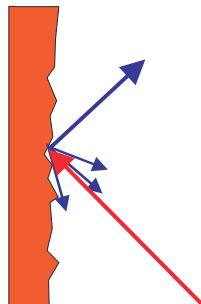

Figure 5: Angle of reflection

Retroreflection

If the reflective energy is greater than 100%, the beam is not reflected diffusely in all directions; instead it is reflected in a targeted way (retroreflection). Thus a large part of the emitted energy can be received by the laser distance measurer. Plastic reflectors (cat's eyes), reflective tape, and triple prisms have these properties.

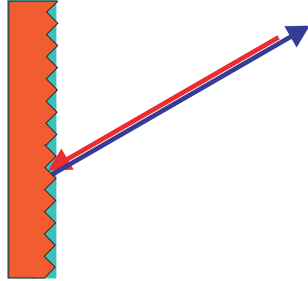

Figure 6: Retroreflection

Reflective surfaces

The laser beam is almost completely deflected on reflective surfaces. This means that an object hit by the deflected beam may be detected instead of the reflective surface.

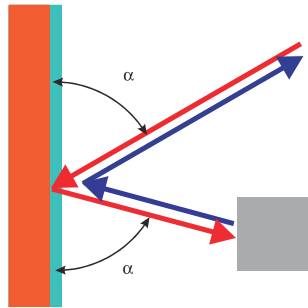

Figure 7: Specular surfaces

Small objects

Objects that are smaller than the diameter of the laser beam cannot reflect the laser light's full energy. The portion of the light beam that does not reach the object is lost. If all of the light reflected to the sensor is insufficient, the object may not be detected.

The portion of the light that does not reach the front object can be reflected by a larger object in the background. If all of the light reflected to the sensor is sufficient, this object is detected. This can lead to a corruption of the measured value.

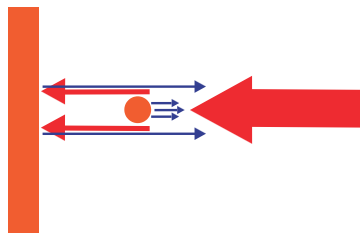

Figure 8: Object smaller than the laser beam diameter

3.5.5 Scanning range

The scanning range of the device depends on the remission of the object to be detected. The better a surface reflects the incident beam back to the device, the greater the scanning range of the device.

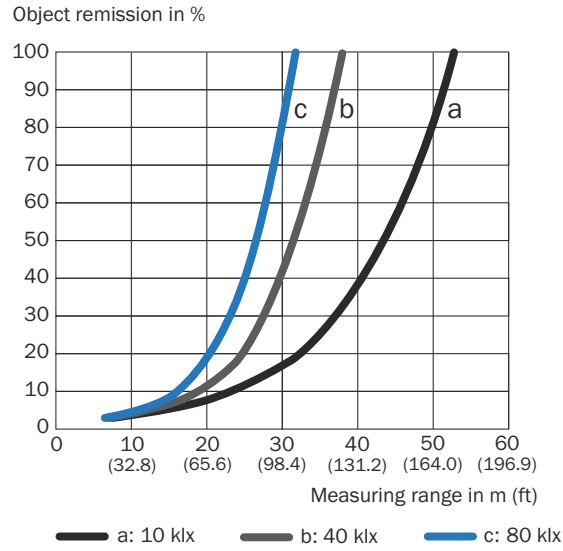

Figure 9: Scanning range as a function of object remission for various ambient light influences (no filter activated; no influence from fog, rain or dust)

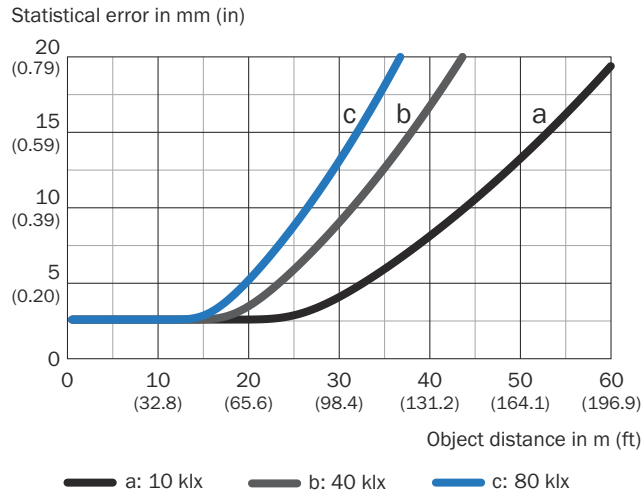

Figure 10: Statistical error for white objects as a function of object distance for various ambient light influences

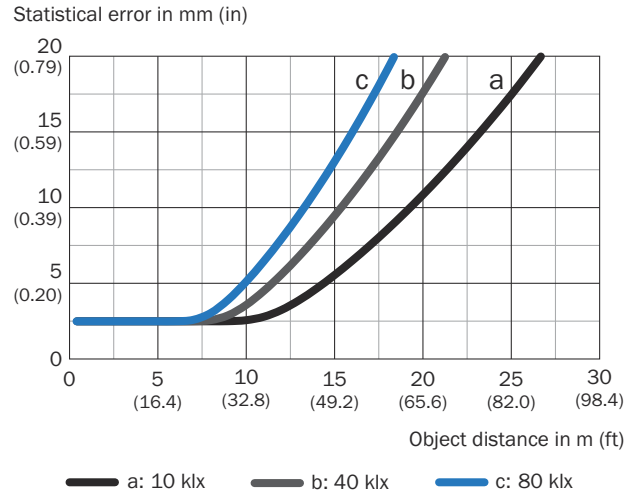

Figure 11: Statistical error for **black objects** as a function of object distance for various ambient light influences

3.5.6 Object sizes

As the distance from the device increases, the laser beam expands. As a result, the diameter of the light spot on the surface of the object increases.



Figure 12: Beam expansion

- ① Expanded laser beam
- ② Optical axis

Values required to calculate the light spot size:

- Light spot size on the device cover: 7 mm (rounded up)
- Divergence of 1 light spot: 0.59 deg (10.4 mrad)
- HDDM+ supplement (1 spot comprises several superimposed individual pulses): 0.50 deg (8.7 mrad)

Formula for calculating the light spot width:

(Light spot divergence [mrad] + HDDM+ supplement [mrad]) x distance [mm] + light spot size on the device cover [mm] = light spot width [mm]

Example calculation of the light spot width at a distance of 16 m (16,000 mm):

$$(10.4 \text{ mrad} + 8.7 \text{ mrad}) * 16,000 \text{ mm} + 7 \text{ mm} = 312.6 \text{ mm}$$

Formula for calculating the height of the light spot:

Light spot divergence [mrad] x Distance [mm] + Light spot height at the n device cover [mm] = Light spot width [mm]

Example calculation of the light spot height at a distance of 16 m (1,600 mm):

$$10.4 \text{ mrad} * 16,000 \text{ mm} + 7 \text{ mm} = 173.4 \text{ mm}$$

Formula for calculating the minimum object size:

(Light spot divergence [mrad] + angular resolution [mrad]) x distance [mm] + light spot height on the device cover [mm] = minimum object size [mm]

Example calculation of the minimum object size at a distance of 16 m (16,000 mm):

$$\text{Angular resolution: } 0.25^\circ \rightarrow 4.4 \text{ mrad}$$

$$(10.4 + 8.7 + 4.4 \text{ mrad}) * 16,000 \text{ mm} + 7 \text{ mm} = 383 \text{ mm}$$

Minimum object size in mm (inch) ①

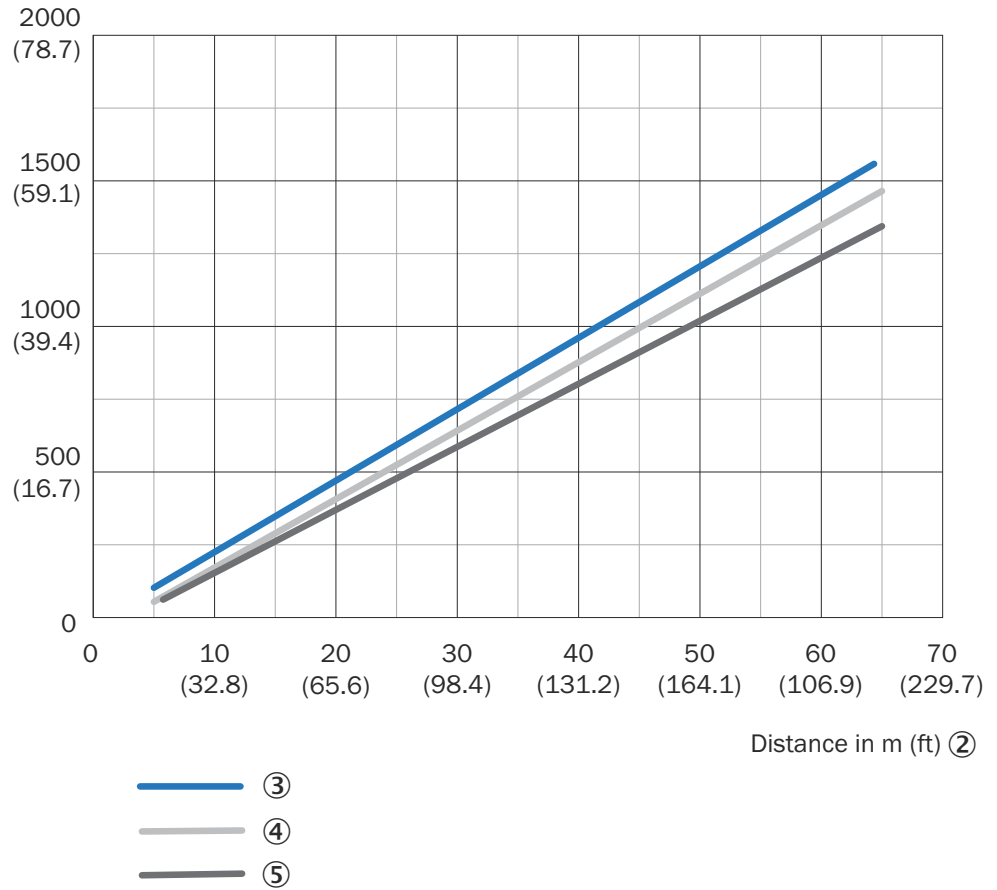

Figure 13: Minimum object size as a function of distance

- ① Minimum object size in mm (inches)
- ② Distance in m (ft)
- ③ Minimum object size
- ④ Minimum object size (2-fold interlaced mode)
- ⑤ Minimum object size (4-fold interlaced mode)



NOTE

For reliable measurement, in particular when using the device to output measured values, the laser needs to hit the object several times. Therefore, the object either needs to be larger than the minimum object size, or both the LiDAR sensor and the object must not be moving.

3.5.7 Multi-echo analysis

The distance between the device and an object is calculated via the time-of-flight of the emitted pulse. The device can evaluate up to three echo signals for each measuring beam to deliver reliable measurement results, even under adverse ambient conditions.

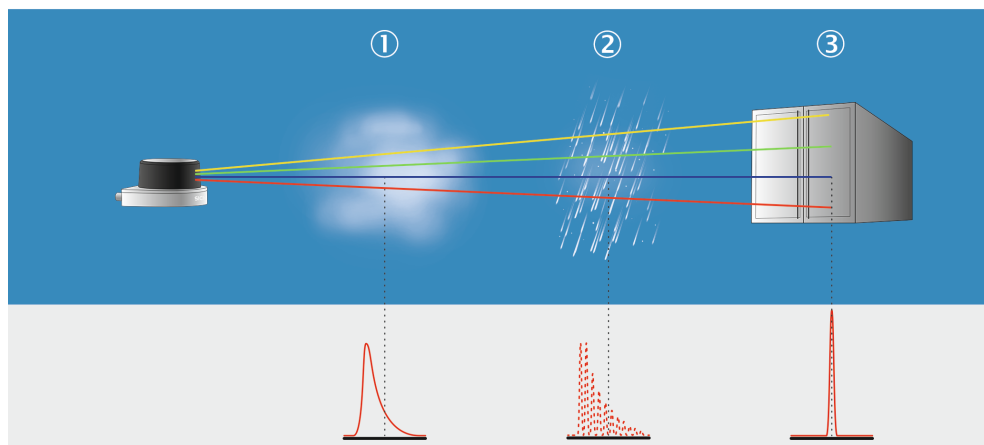

Figure 14: Multi-echo analysis: example industrial application for ports, cranes, and traffic.

- ① Fog
- ② Rain
- ③ Measuring object

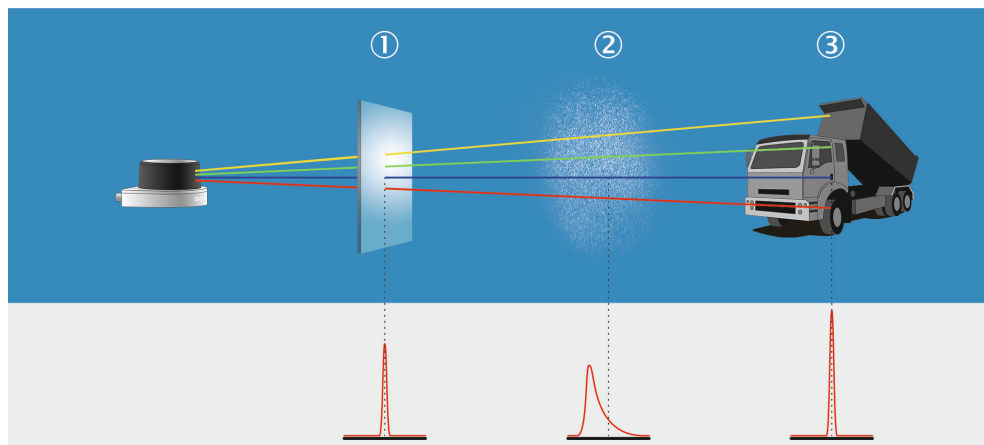

Figure 15: Multi-echo analysis: example industrial application for mining.

- ① Glass pane
- ② Dust
- ③ Measuring object

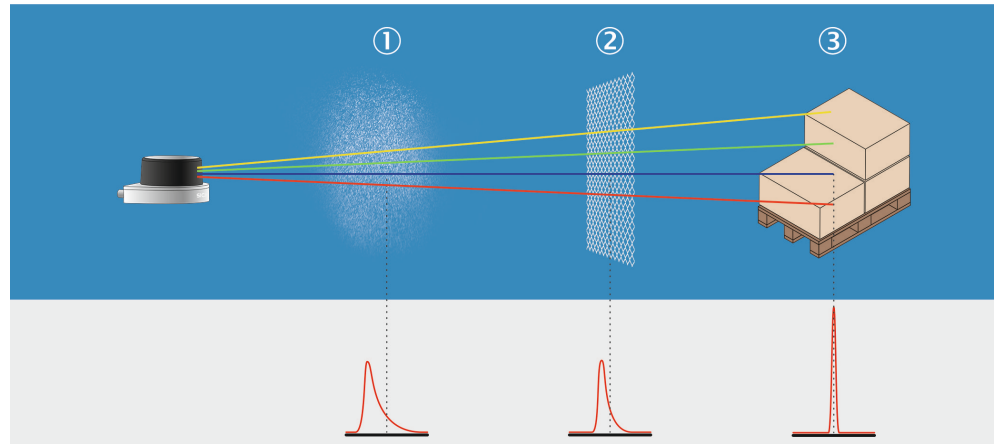

Figure 16: Multi-echo analysis: example industrial application for industrial vehicles.

- ① Dust
- ② Fences
- ③ Measuring object

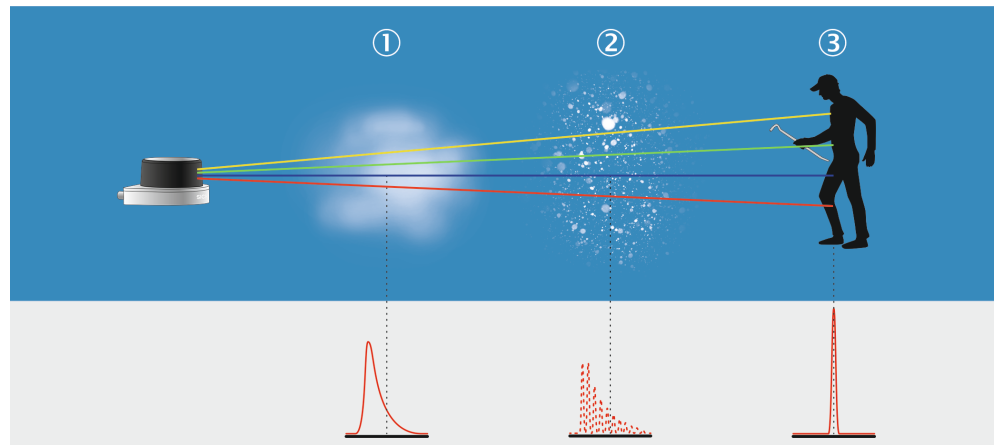

Figure 17: Multi-echo analysis: example industrial application for building management.

- ① Fog
- ② Snow
- ③ Measuring object

3.5.8 Filter

By using digital filters to pre-process and optimize the measured distance values, the device can be tailored to the specific requirements of the respective application. This makes it possible to prevent virtually all faults.

You can arbitrarily combine the filters. If several filters are active, then the filters are applied sequentially to the results of the preceding filter. Processing occurs in the following sequence: echo filter, particle filter, median filter, ground reference evaluation, mean filter. It should be noted, however, that the measurement data output may be delayed due to the multiple calculation steps.

For many applications, it is useful to use a combination of the median filter and the mean filter. The median filter can eliminate the larger outliers, which “smooths” the scan line. The values calculated by the median filter are then averaged over a configurable number of scans by the mean filter.

The active filter functions affect the outputted measured values. It is not possible to recalculate the original measured values from the filtered output values.

3.5.8.1 Echo filter

The echo filter screens out unwanted measurement data and signals caused by edge hits, rain, dust, snow and other ambient conditions.

You can set whether the first, the last, or all three echoes are output.

The other pulses triggered by undesirable ambient conditions are not taken into account.

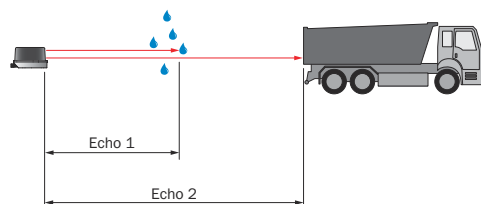

Figure 18: Without the echo filter: The device receives unwanted echoes from ambient conditions such as rain.

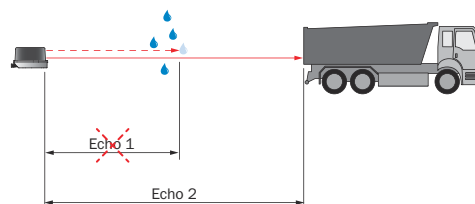

Figure 19: Using the echo filter (setting: last echo): the device screens out unwanted echoes from ambient conditions as per the settings chosen.

3.5.8.2 Fog filter

The fog filter enables the device to eliminate unwanted echoes at close range. This considerably lowers the probability of false activations at close range in fog.

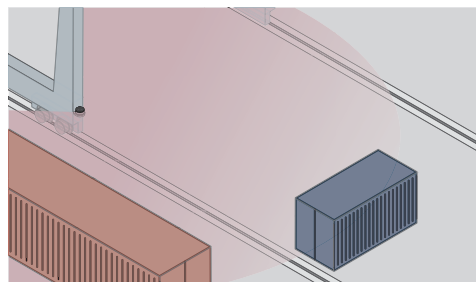

Figure 20: Without the fog filter: objects are difficult to detect through the fog due to reflections.

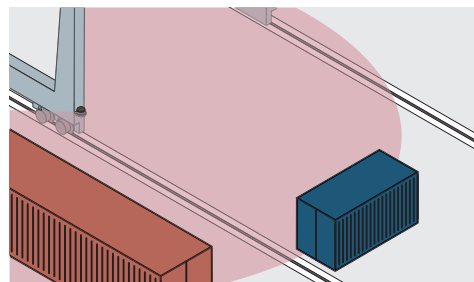

Figure 21: Using the fog filter: objects can be detected reliably because unwanted echoes are screened out.

3.5.8.3 Particle filter

The particle filter blanks small, irrelevant reflection pulses in dusty environments and in rain or snow which are caused by dust particles, raindrops, snowflakes or the like. In doing so, successive scans are continuously evaluated in order to detect static objects.

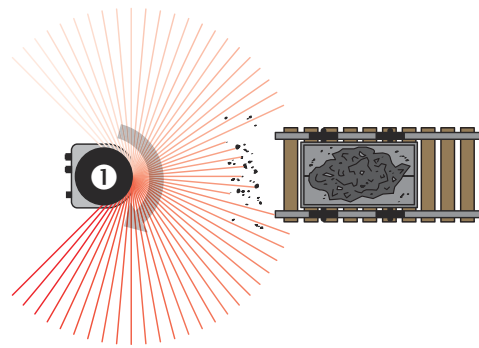

Figure 22: Without the particle filter: Violation of the contour due to dust particles in the vicinity of the object.

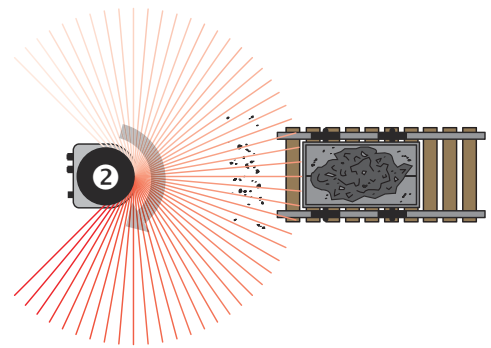

Figure 23: Using the particle filter: The response to dust particles in the field is delayed by one scan. Particles can thereby be blanked.

3.5.8.4 Average filter

Using the mean filter, a blockwise (not moving) arithmetic average is calculated from the configured number of scans and then outputted. The big advantage when using this filter: Potential noise, i.e. minimal deviation of values, is reduced, which also lowers the quantity of data.

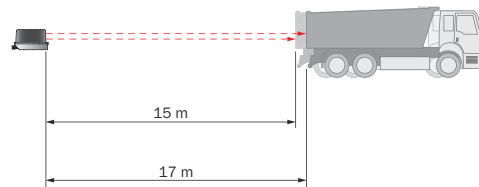

Figure 24: Without the mean filter: The device detects and processes all received signal values.

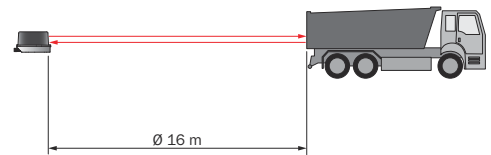

Figure 25: Using the mean filter: The device calculates an average value from several signal values.

3.5.8.5 Median filter

This filter is suitable for excluding individual outliers from the calculation of an average value.

The moving median filter sorts the measured values according to their size and selects the middle value from this sequence. The values taken into consideration are defined by a matrix, the size of which is configurable.

A 3 x 3 matrix, for example, takes into consideration 9 measured values consisting of the distance values of a point and its two neighboring points, along with the distances values of these points determined from the preceding and following scan. The fifth largest measured value is outputted as the distance value.

Table 3: Example: Median for scan 2 and angle 3 (3 x 3 matrix: scan 1 to 3, angle 2 to 4)

	Angle (distance values)					
Scan	1	2	3	4	5	...
1	0	0	850	1100	1150	...
2	0	0	950	1200	1250	...
3	0	0	850	1150	1200	...
...

Median calculation: 0 (lowest value) | 0 | 0 | 850 | **850** (median) | 950 | 1,100 | 1,150 | 1,200 (highest value)

Table 4: Example: Median for scan 2 and angle 4 (3 x 3 matrix: scan 1 to 3, angle 3 to 5)

	Angle (distance values)					
Scan	1	2	3	4	5	...
1	0	0	850	1100	1150	...
2	0	0	950	1200	1250	...
3	0	0	850	1150	1200	...
...

Median calculation: 850 (lowest value) | 850 | 950 | 1,100 | **1150** (median) | 1,150 | 1,200 | 1,200 | 1,250 (highest value)

3.5.8.6 Ground reference evaluation



NOTE

When the ground reference evaluation function is activated, the mean filter is automatically deactivated.

The ground reference evaluation function enables the LiDAR sensor to protect hazardous areas when used in conjunction with automated guided vehicle systems (AGVS). Any objects lying on the path (pallets or small load carriers), or steps and depressions in the ground, are distinguished and detected, thereby avoiding collisions.

The PC software SOPAS ET is used to configure the device and enter the installation location (position of the device), "[Operation with SOPAS ET](#)", page 43. The following application parameters must be taken into consideration and adhered to:

Table 5: Application parameters for ground reference evaluation

Condition	Value
Mounting height	0.3 ... 1.3 m
Tilt angle	+11° ... +30° Overhead mounting ¹ : -10° ... -30° Details see table 6, page 23
Roll angle	± 0.5°
Yaw angle	Flexible
Required accuracy for the configuration data inputs	Mounting height: ± 5 cm Tilt angle: ± 0.5°
Ambient conditions	Indoor applications, level floor surface, no slope, min. corridor width 2 m

¹ the following offset values must be configured for overhead mounting: yaw angle 180°, tilt angle 180°

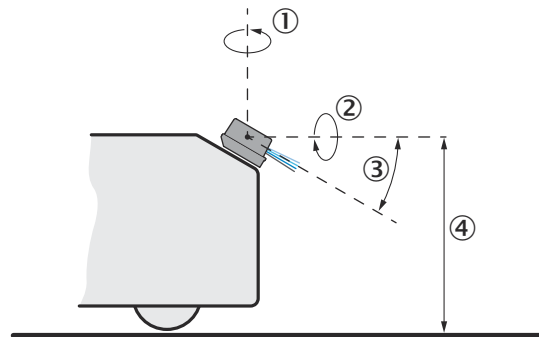

Figure 26: Ground reference evaluation, explanation of application parameters

- ① Yaw angle
- ② Roll angle

- ③ Tilt angle
- ④ Mounting height

Table 6: Detailed data for the tilt angle

Mounting height [m]	Tilt angle [°]	Tilt angle for overhead mounting [°]
0.3	11.0	-10.0
0.4	12.0	-10.0
0.5	13.0	-10.0
0.6	14.0	-11.0
0.7	14.0	-11.5
0.8	15.0	-12.0
0.9	16.0	-13.0
1.0	16.5	-13.5
1.1	17.5	-15.0
1.2	18.5	-16.0
1.3	19.0	-17.0

Based on the aforementioned application parameters, the maximum measuring range is 5 m (for the highest mounting height and lowest tilt angle as per the last table row).

The PC software SOPAS ET also provides several other parameters for adjusting the sensitivity of the ground reference evaluation.

3.5.8.7 Edge filter

The edge filter eliminates erroneous or extreme distance values at edges. These arise as a result of laser light that partially hits an object in the front and partially hits an object farther away, or due to too little light remission at the object itself, [see "Impact of object surfaces on the measurement", page 13](#). The filter evaluates the difference in distance between adjacent points.

When the edge filter is activated, the device sets the distance value to 0 at each edge (values in **bold**) as soon as the parameterized neighbor distance has been exceeded in the edge filter area.

Table 7: Example: Measured values with and without edge filter

Scan	Angle (distance values in mm)							...
	1	2	3	4	5	6	7	
1, not filtered	0	750	1145	1150	1147	1500	0	...
1, filtered	0	0	1145	1150	1147	0	0	...

The edge filter enables points to be entirely suppressed at the outer edges of the object. In this case, the width of an object is detected by up to 2× angular resolution too narrow.

Maximum neighboring distance

The maximum distance difference in millimeters between two measuring points on the edge can be parameterized. A measuring point on the edge that has a greater distance difference than the parameterized value to its adjacent measuring point is taken into account.

Maximum edge filter range (range limitation)

The maximum distance can be set up to 16,000 mm. The measuring points in the parameterized range are taken into account.

3.5.9 Multi-plane technology

The multi-plane technology of the device uses 4 scan planes at different vertical angles to compensate for pitch angle, for example when the device is attached to a vehicle. This enables the device to reliably detect an object even, for example, when the vehicle accelerates or brakes.

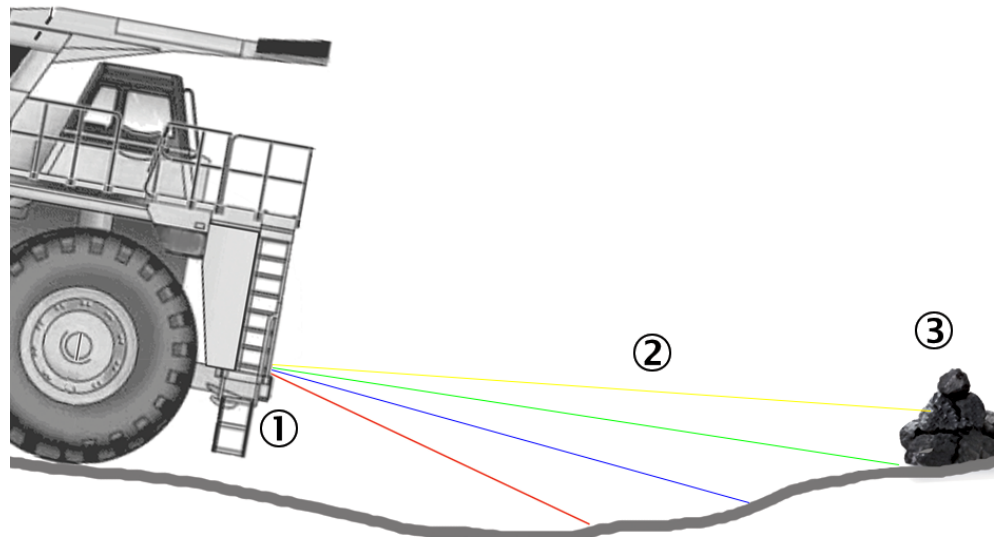

Figure 27: Multi-plane technology

- ① LiDAR sensor
- ② Scan planes
- ③ Object

3.5.10 Scan data output

The device has 4 modules, each of which scans one plane.

The scan data is always outputted on a per module basis (scan plane). The data for a specific plane is outputted every 20 ms. The device requires 80 ms to output the data for all four planes.

In the data message, the individual scans and the associated scan planes are identified by their time stamp and location address.

Data message:

```
<STX>sSN LMDscandata 1 0 1053B01 0 0 8531 8531 299855DA 2A6073CC 0 0 0 0 0 1388 B4 ...
<STX>sSN LMDscandata 1 0 1053B01 0 0 8532 8532 2998A3BB 2A60C6C8 0 0 0 0 FF06 1388 B4 ...
<STX>sSN LMDscandata 1 0 1053B01 0 0 8533 8533 2998F1CF 2A61100C 0 0 0 0 FA 1388 B4 ...
<STX>sSN LMDscandata 1 0 1053B01 0 0 8534 8534 29993FE6 2A615E0B 0 0 0 0 FE0C 1388 B4 ...
```

Time stamp:

- Line 1: **299855DA** = 697849306 = 697849.306 ms
- Line 2: **2998A3BB** = 697869243 = 697869.243 ms
- Difference = 20 ms (corresponds to a scan data output at 50 Hz)

Location address (as per DIN 70000):

- Line 1: **0**= 0 (corresponds to 0°) = Location 2
- Line 2: **FF06**= -250 (corresponds to -2.5°) = Location 3
- Line 3: **FA**= 250 (corresponds to 2.5°) = Location 1
- Line 4: **FE0C**= -500 (corresponds to -5°) = Location 4
- The scans and the outputting of scan data occur in the sequence: Location 2, Location 3, Location 1, Location 4.

Table 8: Address assignment method

Location	DIN 70000	Physical
1	+2.5°	-2.5°
2	0°	0°
3	-2.5°	+2.5°
4	-5°	+5°

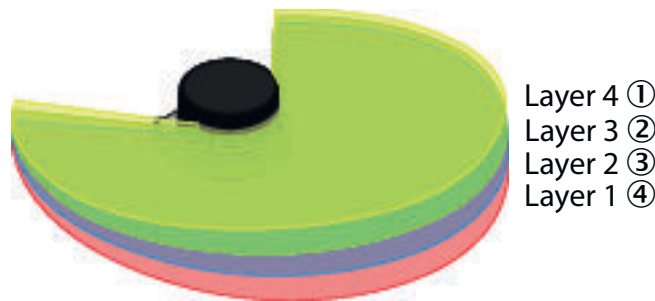

- ① Location 4
- ② Location 3
- ③ Location 2
- ④ Location 1

3.5.11 Interlaced mode

With Interlaced mode, scan data can be acquired with a fine angular resolution even at high scanning frequencies. Recurring sequences of scans are generated.

- Standard: Angular resolution 0.25°, response time: 80 ms
- Dual evaluation: Angular resolution 0.125°, response time: 160 ms
- Quadruple evaluation: Angular resolution 0.0625°, response time: 320 ms

Raw data via LMDscandata telegram

The first scan of a sequence has one scan point more than the other scans of a sequence. This allows the customer to create a scan from a nested sequence. The device sends a telegram after every single scan (rotation). The individual scans of a sequence are not merged into one telegram.

Field evaluation

For the field evaluation, the device internally merges the interlaced sequence to an internal telegram. This data telegram is then used internally to evaluate the fields. It is not available as an output for the customer.

SOPAS ET

The **field evaluation monitor** shows the merged data of a sequence. The **ScanView** displays the individual scans, similar to the LMDscandata telegrams sent to the customer controller. Normally, the jitter of the angular position of the scan points is detectable.

Parameterization via SOPAS ET

The interlaced mode must be activated via SOPAS ET in the default settings and added as an additional mode in the drop-down menu.

Parameterization via telegram

The interlaced mode can be activated with the `mLMPsetsconfig` telegram. The scanning frequency and angular resolution can be set as parameters.

If the device can only adjust to the desired combination of scanning frequency and angular resolution in interlaced mode, then interlaced mode is activated. If this combination is also possible without interlaced mode, it is deactivated.

Technical limits

The interlaced mode is implemented so that three modules of the device are in the scan field when the angle switches for the next interlaced scan. This causes some of the measuring points in the switching range to cause uneven angular steps. This jitter varies depending on the set interlaced mode. Depending on the selected interlaced mode, the jittering of the individual measuring points only affects a defined angular range and not the entire scan field. The actual angle is transmitted by telegram to show the correct position of the measuring points.

The 0° position is located directly in the blind zone of the scan field, shown in yellow in [figure 28](#). For this reason, synchronizing the interlaced mode to one of the four scan planes has no effect.

For the MRS1000, this is the horizontal scan plane.

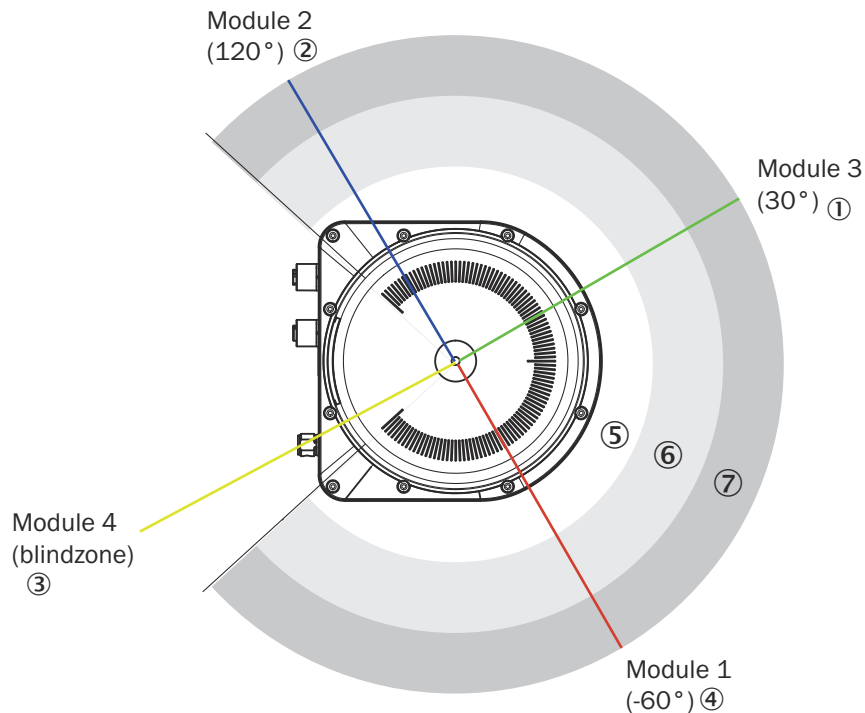

Figure 28: Position of the scan planes when switching to interlaced mode

- ① Module 3 (30°)
- ② Module 2 (120°)
- ③ Module 4 (blind zone)
- ④ Module 1 (-60°)
- ⑤ Near range
- ⑥ Detection zone

⑦ Measuring range

Affected angular range and angular steps:

- With interlaced mode 2x: $\pm 0.125^\circ$

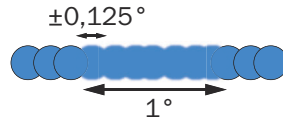

Figure 29: Jittering of the individual measuring points in the affected angular range

- With interlaced mode 4x: $\pm 0.0625^\circ$

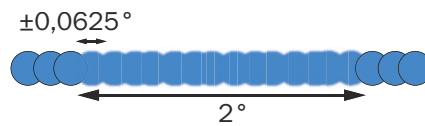

Figure 30: Jittering of the individual measuring points in the affected angular range

Formula for calculating the minimum object size in interlaced mode

For calculation of the minimum object size see "Object sizes", page 16.

With interlaced mode 2x: $(10.4 + 8.7 + 4.4 \text{ mrad} / 2) * 16,000 \text{ mm} + 7 \text{ mm} = 348 \text{ mm}$

With interlaced mode 4x: $(10.4 + 8.7 + 4.4 \text{ mrad} / 4) * 16,000 \text{ mm} + 7 \text{ mm} = 330 \text{ mm}$

3.5.12 RSSI values

RSSI (Received Signal Strength Indicator) is the measure of the signal strength that the device receives. This value is calculated for every measurement. The device therefore provides, for every echo signal, an associated RSSI value for the signal strength.

The RSSI values have a resolution of 8 bits with whole-number values between 1 and 255, where 1 represents the weakest signal and 254 the strongest signal (e.g., with a reflector).

A value of 255 means "dazzled". The value 0 (zero) means that the received energy was too low to produce a valid measured value. A valid distance measurement has at least an RSSI value of 1.

If the RSSI value is 0, then no distance measurement is possible. There can be two reasons for this:

- The target object lies outside the sensing range.
- The target object has an extremely low remission.

Please note that white paper can have very similar values as a reflector at a short distance.

The RSSI values are sensor-specific, relative values that can vary slightly between different devices and during the service life of the device.

3.5.13 Contamination indication

The device has an front screen to protect it. This front screen can get dirty. Contamination reduces the energy emitted and received by the laser beam. As a result, scanned objects appear to have a lower remission than they actually have and, with a certain level of contamination, it will no longer be possible to perform measurements.

The contamination is constantly measured by a separate system during operation. A contamination warning is output first for the different degrees of contamination. If the front screen is not cleaned and contamination increases, then a contamination error is output.

Depending on the application in which the device is used, you can choose from different contamination measurement strategies.

- **Deactivated:** No indication of contamination.
- **High availability:** Contamination warning and contamination errors are only output when the front screen is uniformly contaminated. This means that all 6 sectors must have reached the limit value for a warning or error.
- **Available:** Contamination warning and contamination errors are output when the front screen is partially contaminated. With this strategy, the front screen is divided into two monitored areas (3 sectors on the right half and 3 sectors on the left half). Only when all 3 sectors of a monitored area have reached the limit value for warning or error does the contamination warning or contamination error become active.
- **Semi-sensitive:** Contamination warning and contamination errors are output when the front screen is partially and only slightly contaminated. The sensor evaluates all sectors and activates the contamination warning or contamination error using the following strategy:
 - No warning/error: If the sum of sectors with reached limit value for error = 0 and the sum of sectors with reached limit value for warning ≤ 1
 - Warning: If the sum of sectors with reached limit value for error = 1 and the sum of sectors with reached limit value for warning ≥ 2
 - Error: If the sum of sectors with reached limit value for error ≥ 2
- **Sensitive:** Contamination warning and contamination errors are output even when there is just a little or local contamination. When a sector has reached the limit value for warning or error, the contamination warning or contamination error becomes active.



NOTE

- The cleaner the application environment is, the lower you can set the contamination measurement sensitivity. If a high precision of the measured values is required, the contamination measurement must be set to the most sensitive level.
 - If a weather protection hood is mounted on the device, the accessory combination used must be communicated to the device in SOPAS ET.
-

Contamination warnings and contamination errors are displayed on the status indicators of the device [see "Status indicators", page 10](#).

3.5.14 Calculation of the field size for mobile applications

In order to prevent collisions between vehicles, and between vehicles and fixed objects, the switching field must have sufficient length and width.

To calculate the switching field length, you need to take into consideration the stopping distance of the vehicle. This comprises the following:

- the braking distance, which can be found in the vehicle documentation
- the distance covered during the vehicle control's response time, which can be found in the vehicle documentation
- The distance covered during the response time of the LiDAR sensor, "[Technical data](#)", page 51.



NOTE

- We recommend adding a supplement of at least 100 mm to the protective field length in order to stop the vehicle before a possible collision.
- If retro-reflectors are situated in the path of the vehicles, or if you anticipate that the braking force of the vehicle will diminish over time, you may, under certain circumstances, need to increase the recommended supplement.
- The width of the switching field should cover the vehicle width. You should also configure a supplement of at least 100 mm on every side.

Height of the scan plane

The recommended mounting height for mobile applications is at least 150 mm.

3.5.14.1 Switching field length

You must configure the switching field so that a minimum distance to the vehicle is maintained at all times. This ensures that a vehicle monitored by the LiDAR sensor stops before an object is reached. You can define multiple monitoring cases each with different switching fields. These can be switched over dynamically via static control inputs, for example to adjust the switching field size based on the vehicle speed.

In this kind of application, you must calculate the switching field sizes (in particular the switching field lengths) for all speeds.

The switching field length SL can be calculated using the following formula (guideline values based on a pixel calculation):

$$SL = SA + ZG + ZR + ZB$$

SA = Stopping distance

ZG = General safety supplement for the LiDAR sensor = 100 mm

ZR = Supplement for application-related influences or the selected application parameters

ZB = Supplement for the decreasing braking force of the vehicle. This can be obtained from the relevant vehicle documentation, or alternatively: 10% of the stopping distance.

Stopping distance SA

The stopping distance comprises the vehicle's braking distance and the distance covered during the response time of the LiDAR sensor and the vehicle control's response time.

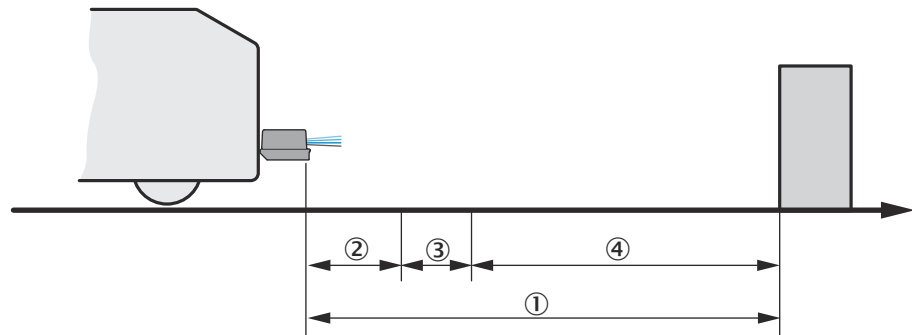

Figure 31: Stopping distance

- ① S_A
- ② S_{AnF}
- ③ S_{AnS}
- ④ S_{Br}



NOTE

Please note that a vehicle’s braking distance does not increase linearly with increasing speed, but rather in a squared relationship. This is particularly important if you switch between different-sized switching fields depending on the speed.

How to calculate the stopping distance S_A :

$$S_A = S_{AnF} + S_{AnS} + S_{Br}$$

S_{AnF} = The distance covered during the vehicle control’s response time, which is specified in the vehicle documentation

S_{AnS} = The distance covered during the response time of the LiDAR sensor

S_{Br} = The braking distance, found in the vehicle documentation

The distance S_{AnS} covered during the response time of the LiDAR sensor depends on:

- the response time of the LiDAR sensor
- the maximum speed of the vehicle in your mobile application

For more information on the response time T_S of the LiDAR sensor, see "Technical data", page 51.

How to calculate the distance S_{AnS} covered during the response time of the LiDAR sensor:

$$S_{AnS} = T_S \times V_{max}$$

T_S = Response time of the LiDAR sensor

V_{max} Maximum speed of the vehicle, from the relevant vehicle documentation

The response time T_S of the LiDAR sensor depends on:

- the base response time of the LiDAR sensor
- whether multiple sampling is set
- the filter settings (e.g., particle filter).

ZR supplement

This supplement must be determined on an application-specific basis and taken into account appropriately. The following factors can make it necessary to use a supplement: reflectors or shiny objects on the scan plane, multi-echo analysis, blanking size, device filter (e.g., particle filter).

3.5.14.2 Switching field width

The width of the switching field must cover the width of the vehicle and take into account the supplements for the measurement error.

The switching field width SB can be calculated using the following formula (guideline values based on a pixel calculation):

$$SB = FB + 2 \times (ZG + ZR)$$

FB = Vehicle width

ZG = General safety supplement for the LiDAR sensor = 100 mm

ZR = Supplement for application-related influences or the selected application parameters

4 Transport and storage

4.1 Transport

For your own safety, please read and observe the following notes:



NOTICE

Damage to the product due to improper transport.

- The device must be packaged for transport with protection against shock and damp.
- Recommendation: Use the original packaging as it provides the best protection.
- Transport should be performed by trained specialist staff only.
- The utmost care and attention is required at all times during unloading and transportation on company premises.
- Note the symbols on the packaging.
- Do not remove packaging until immediately before you start mounting.

4.2 Unpacking

- To protect the device against condensation, allow it to equilibrate with the ambient temperature before unpacking if necessary.
- Handle the device with care and protect it from mechanical damage.
- To avoid ingress of dust and water, only remove the protective caps of the electrical connections just before attaching the connecting cable.

4.3 Transport inspection

Immediately upon receipt in Goods-in, check the delivery for completeness and for any damage that may have occurred in transit. In the case of transit damage that is visible externally, proceed as follows:

- Do not accept the delivery or only do so conditionally.
- Note the scope of damage on the transport documents or on the transport company's delivery note.
- File a complaint.



NOTE

Complaints regarding defects should be filed as soon as these are detected. Damage claims are only valid before the applicable complaint deadlines.

4.4 Storage

Store the device under the following conditions:

- Recommendation: Use the original packaging.
- Electrical connections are provided with a protective cap (as in the delivery condition).
- Do not store outdoors.
- Store in a dry area that is protected from dust.
- To allow any residual dampness to evaporate, do not package in airtight containers.
- Do not expose to any aggressive substances.
- Protect from sunlight.
- Avoid mechanical shocks.
- Storage temperature: see "Technical data", page 51.

- Relative humidity: [see "Technical data", page 51.](#)
- For storage periods of longer than 3 months, check the general condition of all components and packaging on a regular basis.

5 Mounting

5.1 Mounting instructions

- Observe the technical data.
- Protect the sensor from direct sunlight.
- To prevent condensation, avoid exposing the device to rapid changes in temperature.
- The mounting site has to be designed for the weight of the device.
- The device can be mounted in any position.
- It should be mounted so that it is exposed to as little shock and vibration as possible. Optional mounting accessories are available, [see "Accessories", page 56](#).
- Regularly check the tightness of the fixing screws.
- For indoor mounting, use a protection hood if necessary, for outdoor installation use a weather protection hood if necessary (both optional accessories), [see "Accessories", page 56](#).
- Do not mount the device on or directly in front of a bright metallic surface or other reflective surface, since reflections can falsify the measurements.
- Do not place magnetic objects on the optics cover, since they can disturb the angular measurement.
- Avoid having shiny or reflective surfaces in the scanning range, e.g., stainless steel, aluminum, glass, reflectors, or surfaces with these types of coatings.
- Protect the device from moisture, contamination, and damage.
- Make sure that the status indicator is clearly visible.
- Do not affix any labels or stickers to the optics cover.
- Do not subject the device to excessive shock or vibrations. In systems subjected to heavy vibrations, secure the fixing screws with screw-locking devices.

5.2 Mounting device

1. Mount the device in a suitably prepared bracket using the fixing holes provided ([see "Dimensional drawing", page 54](#)). Mounting brackets are available as accessories, [see "Accessories", page 56](#).
2. Make the electrical connection. Attach and tighten a voltage-free cable, [see "Connecting the device electrically", page 42](#).
3. Align the vertical center line of the field of view of the device with the center of the area to be monitored. The marking on the upper side of the optics hood serves as a bearing alignment aid.



NOTE

By enabling alignment mode, it is possible to activate a single one of the four scan planes. This makes it easier to align the device using this selected reference plane.

4. Switch on the supply voltage.
- ✓ After successful initialization, the two status LEDs light up green. The device is ready for use.
5. Perform a fine adjustment using a test target and, if necessary, use the alignment aid.

5.3 Mounting multiple devices



NOTICE RISK OF INTERFERENCE FROM OTHER DEVICES!

Radiation sources with a wavelength of 850 nm can cause interference if they affect the device directly.

The device has been designed to minimize the probability of mutual interference, including between different LiDAR sensors. To rule out even the slightest effects on the measurement accuracy, the devices should be arranged such the laser beams are not received by another device.

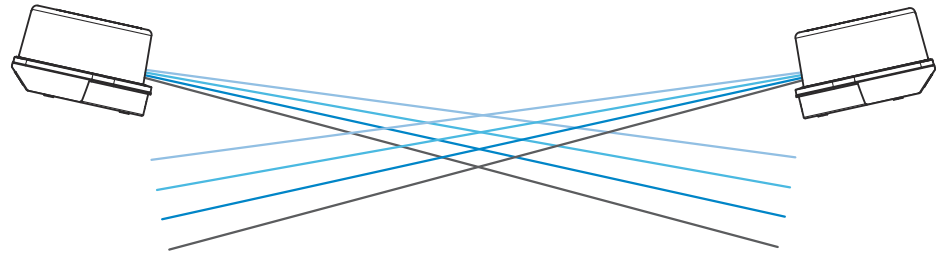

Figure 32: Arrangement for 2 devices

6 Electrical installation

6.1 Wiring instructions



NOTE

Pre-assembled cables can be found online at:

- www.sick.com/MRS1000
-



NOTICE

Faults during operation and device or system defects!

Incorrect wiring may result in operational faults and defects.

- Follow the wiring notes precisely.
-

All electrical connections of the device are configured as M12 round connectors.

The enclosure rating stated in the technical data is achieved only with screwed plug connectors or protective caps.

All circuits connected to the device must be configured as SELV or PELV circuits. SELV = safety extra-low voltage, PELV = protective extra-low voltage.

Observe the following notes to ensure safe and trouble-free operation:

- Connect the connecting cables in a de-energized state. Do not switch on the supply voltage until installation is complete and all connecting cables have been connected to the device and control.
- Wire cross-sections in the supply cable from the customer's power system should be designed in accordance with the applicable standards. Protect the device with an external slow-blow fuse of 5 A at the beginning of the supply cable, viewed from the voltage supply.
- The specified enclosure rating of the device when mounted is reached only if suitable mating connectors or protective caps are used.
- Do not open the screwed housing of the device, since the warranty will then become void.
- Turn the rotatable electrical connections max 270° from end position to end position.
- Prior to connecting the I/O line, check the device configuration for the inputs/ outputs.
- Avoid tensile loads to the connecting cables.
- Maximum cable lengths for the voltage supply depending on the power supply voltage used (conditions: cable cross-section 0.34 mm², 20 °C cable temperature, 10 V applied to the device, max. power consumption as per type label): 6.5 m at 12 V; 46.5 m at 24 V; 66.5 m at 30 V.

6.2 Prerequisites for safe operation of the device



WARNING

Risk of injury and damage caused by electrical current!

As a result of equipotential bonding currents between the device and other grounded devices in the system, faulty grounding of the device can give rise to the following dangers and faults:

- Dangerous voltages are applied to the metal housings.
- Devices will behave incorrectly or be destroyed.
- Cable shielding will be damaged by overheating and cause cable fires.

Remedial measures

- Only skilled electricians should be permitted to carry out work on the electrical system.
- If the cable insulation is damaged, disconnect the voltage supply immediately and have the damage repaired.
- Ensure that the ground potential is the same at all grounding points.
- Where local conditions do not meet the requirements for a safe earthing method, take appropriate measures. For example, ensure low-impedance and current-carrying equipotential bonding.

The device is connected to the peripheral devices (voltage supply, any local trigger sensor(s), system controller) via shielded cables. The cable shield – for the data cable, for example – rests against the metal housing of the device. The device can be grounded through the cable shield or through a blind tapped hole in the housing, for example.

If the peripheral devices have metal housings and the cable shields are also in contact with their housings, it is assumed that all devices involved in the installation have the **same ground potential**.

This is achieved by complying with the following conditions:

- Mounting the devices on conductive metal surfaces
- Correctly grounding the devices and metal surfaces in the system
- If necessary: low-impedance and current-carrying equipotential bonding between areas with different ground potentials

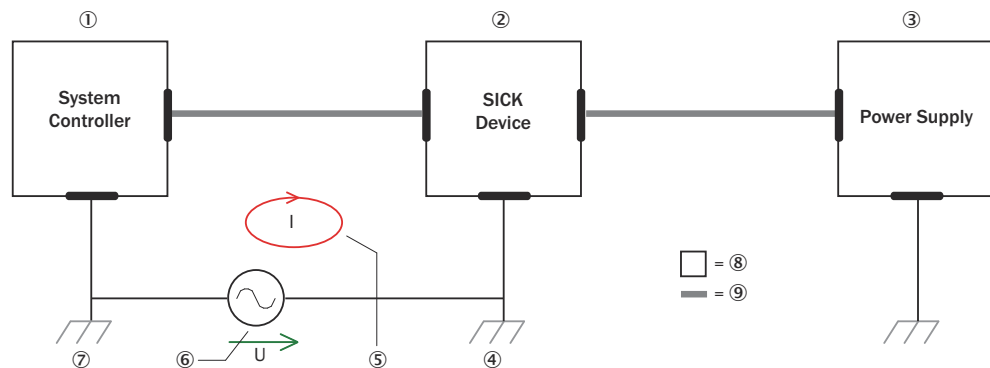

Figure 33: Example: Occurrence of equipotential bonding currents in the system configuration

- ① System controller
- ② Device
- ③ Voltage supply
- ④ Grounding point 2
- ⑤ Closed current loop with equalizing currents via cable shield
- ⑥ Ground potential difference

- ⑦ Grounding point 1
- ⑧ Metal housing
- ⑨ Shielded electrical cable

If these conditions are not fulfilled, equipotential bonding currents can flow along the cable shielding between the devices due to differing ground potentials and cause the hazards specified. This is, for example, possible in cases where there are devices within a widely distributed system covering several buildings.

Remedial measures

The most common solution to prevent equipotential bonding currents on cable shields is to ensure low-impedance and current-carrying equipotential bonding. If this equipotential bonding is not possible, the following solution approaches serve as a suggestion.



NOTICE

We expressly advise against opening up the cable shields. This would mean that the EMC limit values can no longer be complied with and that the safe operation of the device data interfaces can no longer be guaranteed.

Measures for widely distributed system installations

On widely distributed system installations with correspondingly large potential differences, the setting up of local islands and connecting them using commercially available **electro-optical signal isolators** is recommended. This measure achieves a high degree of resistance to electromagnetic interference.

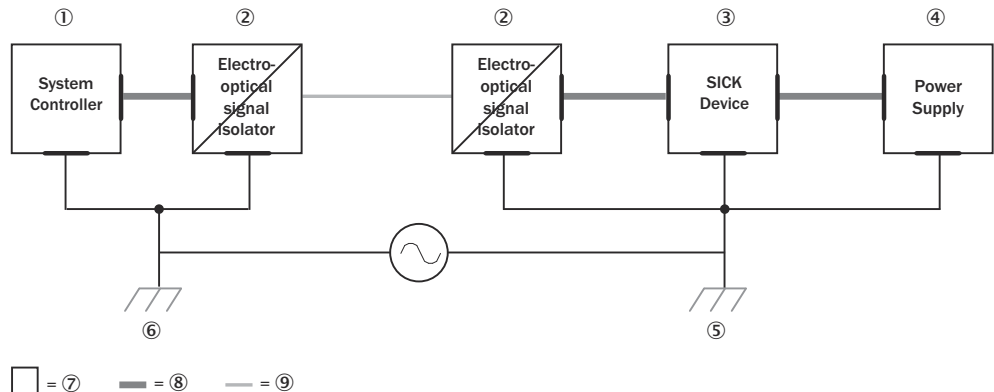

Figure 34: Example: Prevention of equipotential bonding currents in the system configuration by the use of electro-optical signal isolators

- ① System controller
- ② Electro-optical signal isolator
- ③ Device
- ④ Voltage supply
- ⑤ Grounding point 2
- ⑥ Grounding point 1
- ⑦ Metal housing
- ⑧ Shielded electrical cable
- ⑨ Optical fiber

The use of electro-optical signal isolators between the islands isolates the ground loop. Within the islands, a stable equipotential bonding prevents equalizing currents on the cable shields.

Measures for small system installations

For smaller installations with only slight potential differences, insulated mounting of the device and peripheral devices may be an adequate solution.

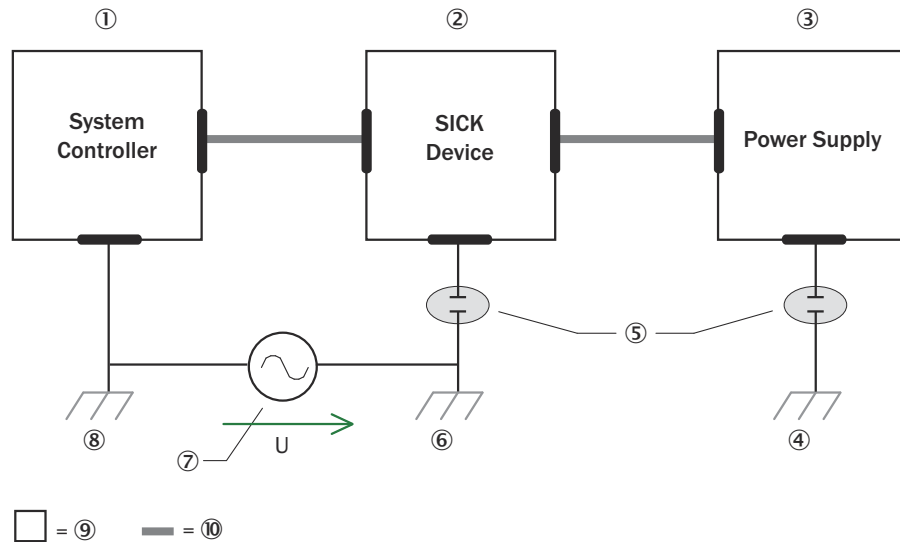

Figure 35: Example: Prevention of equipotential bonding currents in the system configuration by the insulated mounting of the device

- ① System controller
- ② Device
- ③ Voltage supply
- ④ Grounding point 3
- ⑤ Insulated mounting
- ⑥ Grounding point 2
- ⑦ Ground potential difference
- ⑧ Grounding point 1
- ⑨ Metal housing
- ⑩ Shielded electrical cable

Even in the event of large differences in the ground potential, ground loops are effectively prevented. As a result, equalizing currents can no longer flow via the cable shields and metal housing.



NOTICE

The voltage supply for the device and the connected peripheral devices must also guarantee the required level of insulation.

Under certain circumstances, a tangible potential can develop between the insulated metal housings and the local ground potential.

6.3 Connection diagram



NOTE

The recommended connecting cables and their associated technical data can be found online at:

www.sick.com/MRS1000

PWR connection

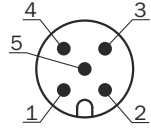

Figure 36: Male connector M12, 5-pin, A-coded

Table 9: Pin assignment for PWR connection

Pin	Identification	Description	Wire color, part number 2095733 ¹
1	Vs	Supply voltage: +10 ... +30 V DC	Brown
2	-	Reserved	White
3	GND	Supply voltage: 0 V	Blue
4	IN8 / OUT8	Digital input 8 / digital output 8	Black
5	-	Reserved	Gray

¹ Information only valid when using the specified open-ended connecting cable which is available as an accessory

Ethernet connection

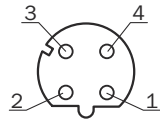

Figure 37: M12 female connector, 4-pin, D-coded

Table 10: Pin assignment for Ethernet connection

Pin	Identification	Description
1	TX+	Sender+
2	RX+	Receiver+
3	TX-	Sender-
4	RX-	Receiver-

I/O connection

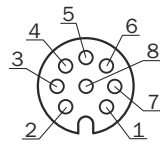

Figure 38: Female connector, M12, 8-pin, A-coded

Table 11: Pin assignment for I/O connection

Pin	Identification	Description	Wire color, part number 6036155 ¹
1	IN1 / OUT1	Digital input 1 / digital output 1	White
2	IN2 / OUT2	Digital input 2 / digital output 2	Brown
3	IN3 / OUT3	Digital input 3 / digital output 3	Green
4	IN4 / OUT4	Digital input 4 / digital output 4	Yellow
5	IN5 / OUT5	Digital input 5 / digital output 5	Gray
6	IN6 / OUT6	Digital input 6 / digital output 6	Pink

Pin	Identification	Description	Wire color, part number 6036155 ¹
7	GND INx/OUTx	Ground for all digital inputs / outputs	Blue
8	IN7 / OUT7	Digital input 7 / digital output 7	Red

¹ Information only valid when using the specified open-ended connecting cable which is available as an accessory

6.4 Connection options

The following illustrations show several wiring examples based on the different types of inputs and outputs used.

Inputs:

- IN1-3: Field set switching
- IN4: EasyTeach teach-in

Outputs (maximum output current, "Technical data", page 51):

- OUT5: EasyTeach cut-off path (evaluation)
- OUT6: Cut-off path for subsequent evaluations
- OUT7: EasyTeach confirmed indicator (signals teach-in)
- OUT8: Device ready indicator

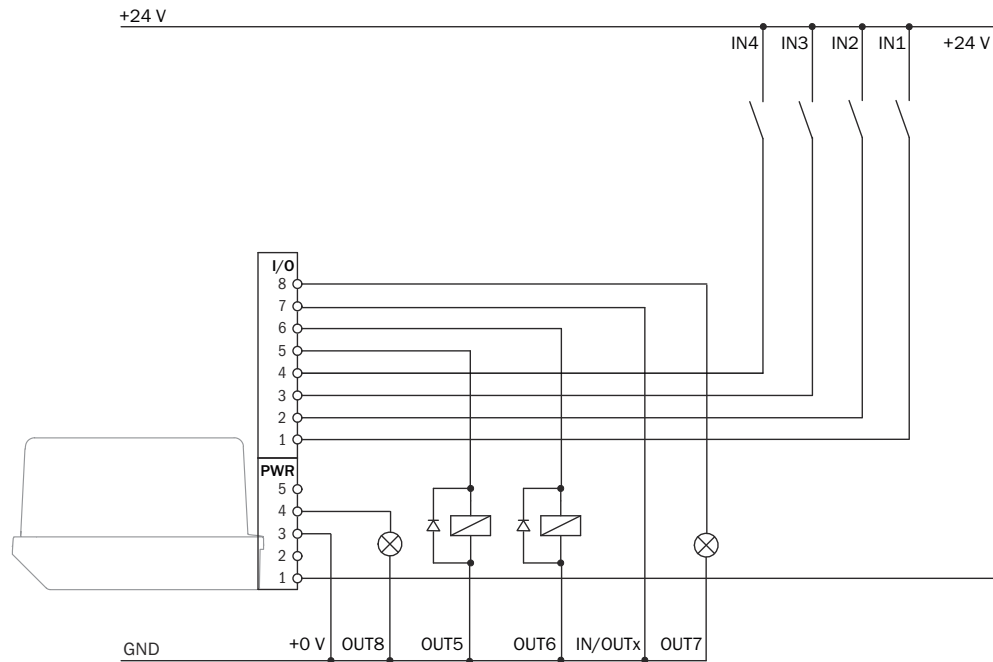

Figure 39: Connection example with PNP outputs and active high inputs (default)

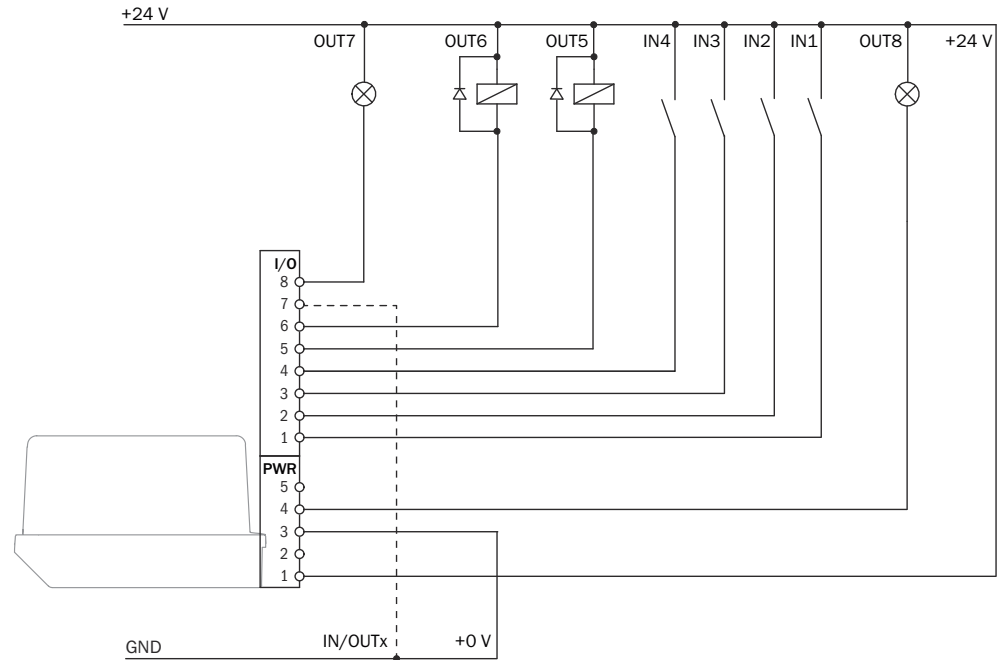

Figure 40: Connection example with NPN outputs and active high inputs

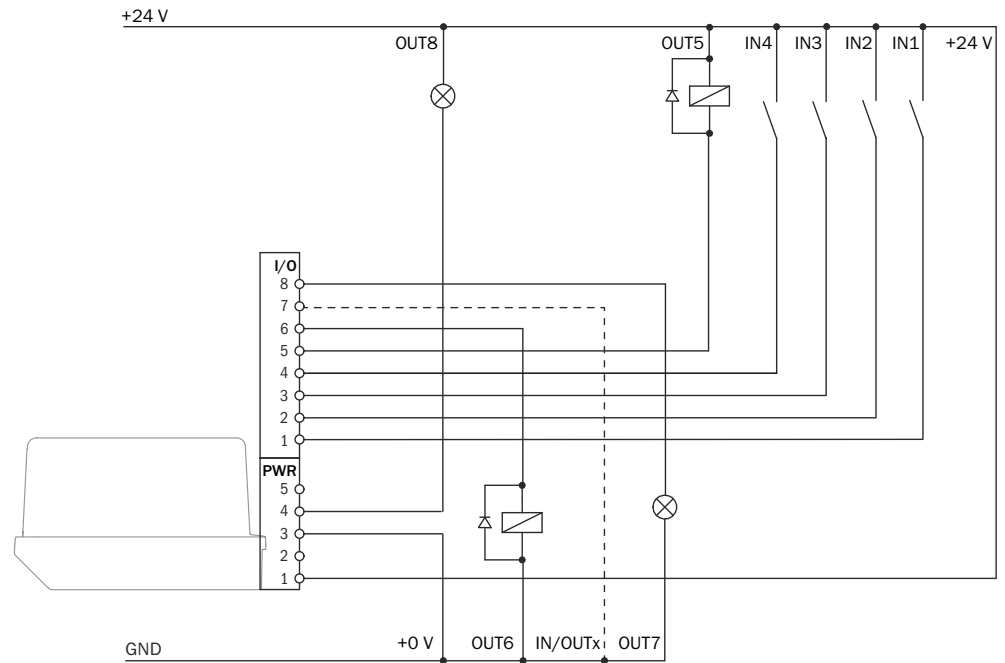

Figure 41: Connection example with push-pull outputs and active high inputs

6.5 Connecting the device electrically



NOTICE

Observe the wiring instructions (see "Wiring instructions", page 36) and prerequisites for safe operation (see "Prerequisites for safe operation of the device", page 37).

1. Ensure the voltage supply is not connected.
2. Connect the device according to the connection diagram, see "Connection diagram", page 39.
Examples for the connection options, see "Connection options", page 41.

7 Operation

7.1 Operation with SOPAS ET

Version 3.3.3 and higher of the SOPAS Engineering Tool (SOPAS ET) software can be used for parameterization of the device and for service and diagnostic purposes.

To configure the device, you will require a computer with SOPAS ET installed and a free Ethernet connection. Alternatively, the connection can be established via a USB connection using an Ethernet USB adapter.



NOTE

The most up-to-date version of the SOPAS ET software can be downloaded from www.sick.com/SOPAS_ET. The respective system requirements for installing SOPAS ET are also specified there.

1. Connect the communication interface (Ethernet, 4-pin M12 female connector) of the device to the computer.
 2. Switch on and start the computer.
 3. Supply the device with voltage (5-pin M12 male connector, supply voltage 10 ... 30 V DC).
- ✓ After successful initialization, the two status LEDs light up green. The device is ready for use.



NOTE

To use SOPAS ET with the device, you need a device description file (SDD, SOPAS Device Description) for this device. You can install this within SOPAS ET using the device catalog. The device description file is saved on the device and can be installed there. Alternatively, installation is possible from the SICK website (Internet connection required).

Following installation of the device description file, the device can be selected from the device catalog and added to a project.

A connection to the device is established via the communication interface. The connection must be activated for data transmission (**online**).

Certain functions (e.g., Edit parameters) require you to be logged in to the device (**Device** > **Log In** menu, **User Level**: Authorized customer, **Password** (factory default): client).

Table 12: Passwords

User levels	Password
Maintenance	main
Authorized client	client
Service	service level



NOTE

Change the passwords at initial commissioning to ensure your device is protected.

Information about the device is displayed in the device window and the device can also be configured here (**Device**> **Open** menu).

Description of the device window

The device window features various views supporting a selection of functions:

- **Start:** Start device configuration with display of information about the device (left-hand side) and display of the current scan (right-hand side).

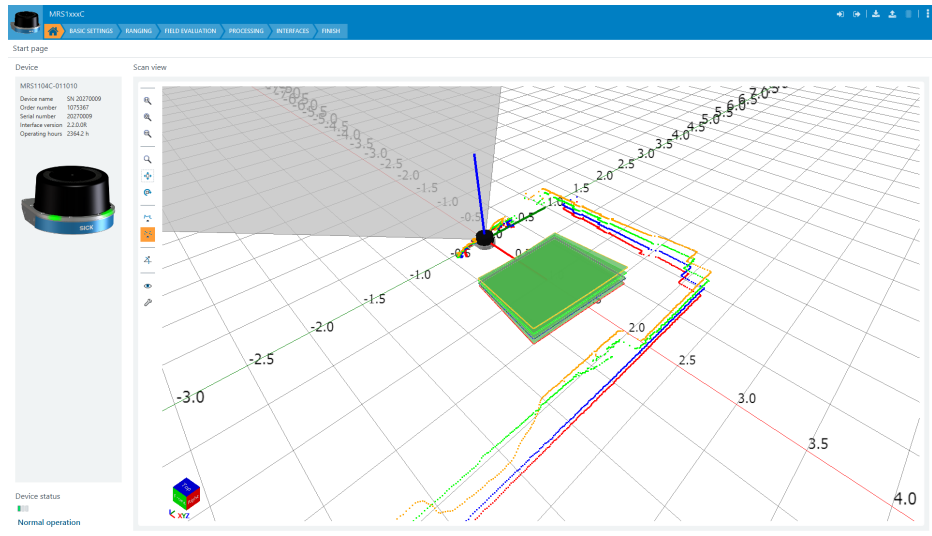

The scan view can be customized with the assistance of various tools (to the left of the scan view), for example:

- : Resets scan display to default view.
- : Displays measured values as points or lines.
- : Freely rotates scan display.
- : Changes the perspective of the LiDAR sensor.

- **Default:** Scan display (left-hand side), entry of the device parameters as well as display of the IMU (inertial measurement unit) data, entry of the mounting position as well as parameterization of the contamination indication (right-hand side):

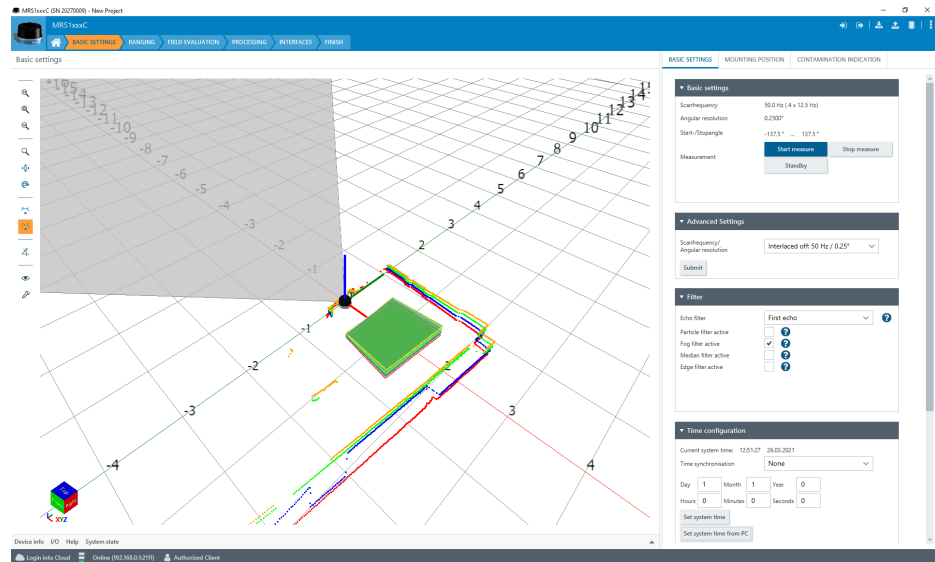

- **Setup mode:** Optionally activate one of the four scan planes used for alignment.
- **Distance measurement:** input fields for output data format, output control and output range (right-hand side).

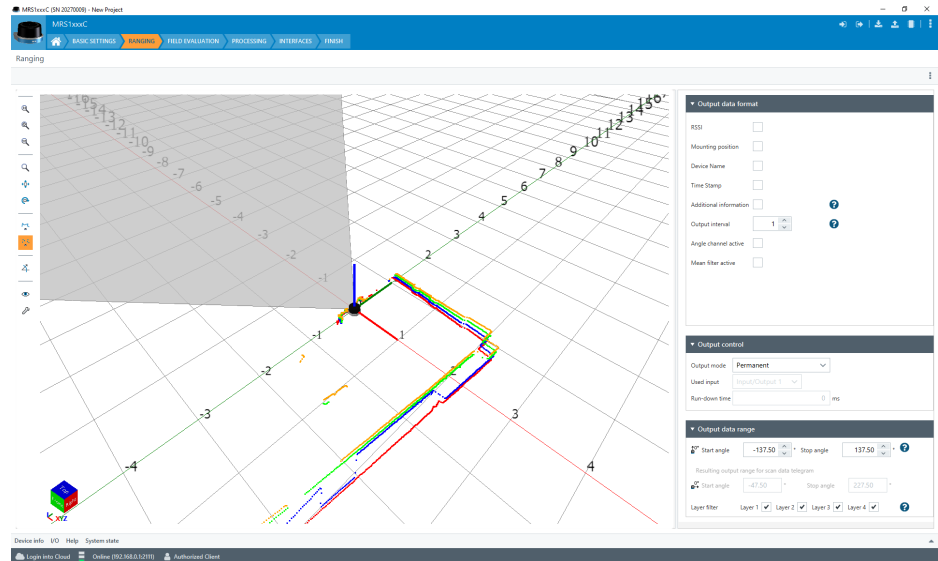

▼ Output data format

RSSI

Mounting position

Device Name

Time Stamp

Additional information ?

Output interval ?

Angle channel active

Mean filter active

- **Field evaluation:** Scan display for adapting the field geometry (left-hand side) and entering detection parameters (right-hand side):

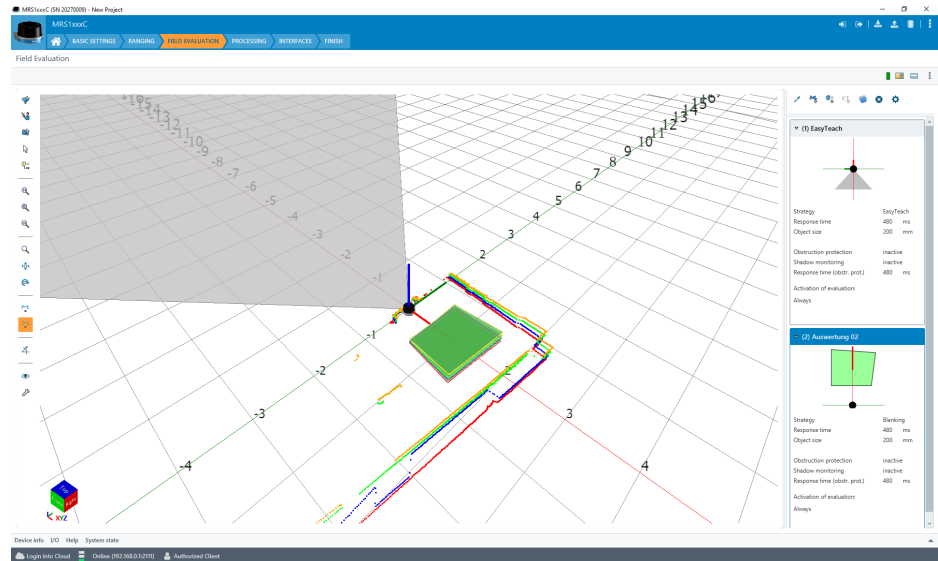

The **Edit field points** tool (mouse pointer in the list of tools to the left of the scan view) can be used to customize the field geometry with the assistance of the mouse pointer. Alternatively, the field vertices can also be customized by entering the coordinate values in the **Field coordinates** mask.

Table 13: Options for editing the field geometry with the mouse pointer

Function	Procedure
Scale field	Drag square red handle.
Rotate field	Drag round black handle.
Customize field shape	Drag square green handle.
Add field vertices	Double-click in required position.
Remove field vertex	Click to select square green handle and press the [del] key.
Delete field	Press the [del] pushbutton without first selecting a green handle.
Insert new field (function is only available if a field has not been created)	Select Insert field points tool, click to set field vertices, and double-click last field vertex to close the field.



NOTE

Fields are defined on the y global plane.

Depending on the mounting location of the device (specified in the Default view), the fields are then projected onto the individual scan planes (layers).

- **Processing:** Further input fields for field evaluation processing (e.g. minimum perpendicular distance to reference line, direction detection)

Processing

Field evaluation processing

(1) EasyTeach

(2) Auswertung 02

- **Interfaces.** Configuration of the interfaces (left-hand side) and input of communication parameters (right-hand side).

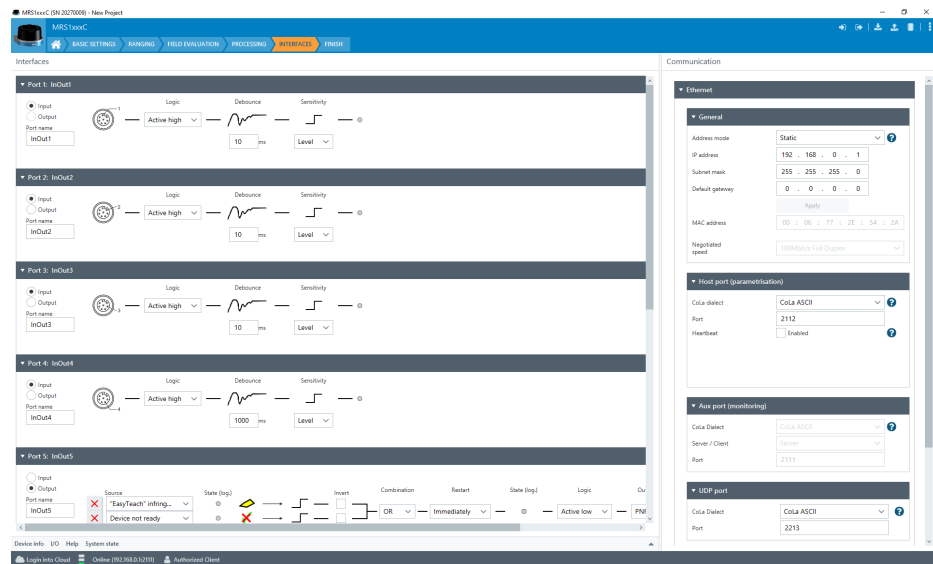

- **Complete:** Scans display (left-hand side) and buttons for finalizing the device parameterization and for system status/system diagnosis.

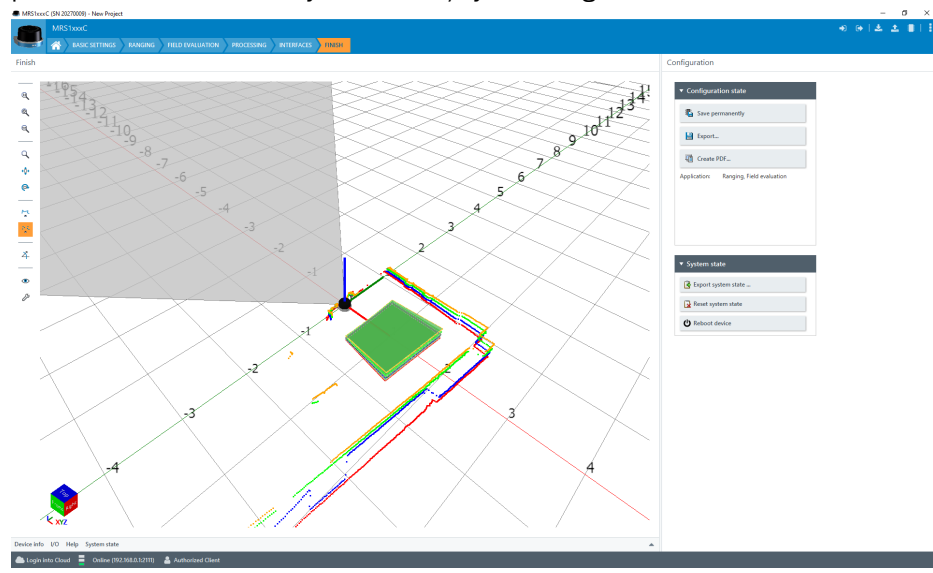

NOTE

Changes to parameters that are made in SOPAS ET are not saved automatically in the device. After you have completed the configuration, you must save it in the device permanently by pressing the **Save permanent** button.



NOTE

For examples of using the software and the configuration options in the device window, refer to the annex, see ["Configuration with computer"](#), page 58.

Terminal program description

The terminal program is started in the main window of SOPAS via the **Tools > Terminal** menu.

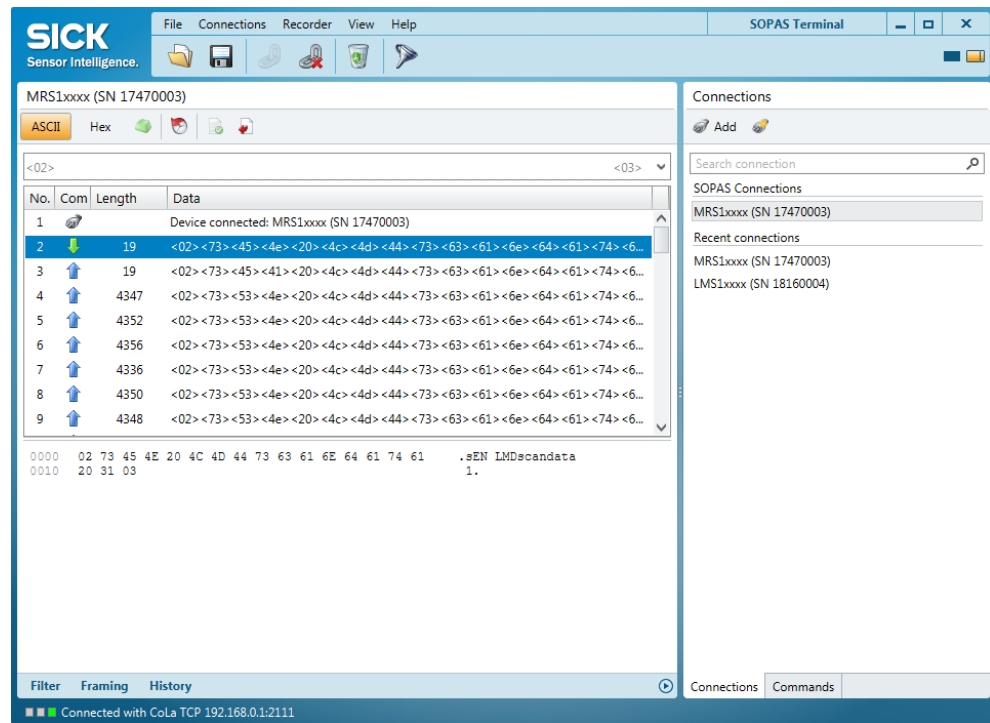
**NOTE**

For examples of using the software and the configuration options in the terminal program, refer to the annex, "[Output of measured values via terminal program](#)", page 58.

7.2 Operation with teach-in

For the field evaluation application, it is possible to configure the device using the field contour teach-in (EasyTeach) function rather than configuring it via SOPAS. The teach-in phase can be activated / deactivated via an input circuit or SOPAS.

**NOTE**

For an example of configuring the device using EasyTeach and for an input circuit, refer to the annex, "[Configuration without computer](#)", page 57.

8 Maintenance

8.1 Maintenance plan

During operation, the device works maintenance-free.

Depending on the assignment location, the following preventive maintenance tasks may be required for the device at regular intervals:

Table 14: Maintenance plan

Maintenance work	Interval	To be carried out by
Check device and connecting cables for damage at regular intervals.	Depends on ambient conditions and climate.	Specialist
Clean housing and optics cover.	Depends on ambient conditions and climate.	Specialist
Check the screw connections and plug connectors.	Depends on the place of use, ambient conditions or operating requirements. Recommended: At least every 6 months.	Specialist
Check that all unused connections are sealed with protective caps.	Depends on ambient conditions and climate. Recommended: At least every 6 months.	Specialist

8.2 Cleaning



NOTICE

Equipment damage due to improper cleaning.

Improper cleaning may result in equipment damage.

- Only use recommended cleaning agents and tools.
- Never use sharp objects for cleaning.

- ▶ Clean the optics hood at regular intervals and in the event of contamination using a lint-free lens cloth (part no. 4003353) and plastic cleaning agent (part no. 5600006). Rinse off coarse dirt first with water. The cleaning interval essentially depends on the ambient conditions.

9 Troubleshooting

9.1 General faults, warnings, and errors

Possible errors and corrective actions are described in the table below. In the case of errors that cannot be rectified using the information below, please contact the SICK Service department. To find your agency, see the final page of this document.



NOTE

Before calling, make a note of all type label data such as type designation, serial number, etc., to ensure faster telephone processing.

Table 15: Troubleshooting questions and replies

Question / status	Response / remedial actions
Both LEDs flash red.	Device fault: Read out the fault code via the PC software SOPAS ET and remedy the cause of the fault.
LEDs indicate an undefined status.	Check the device status, if necessary contact the SICK Service department.
Measurement data show anomalies.	Optics cover contaminated: Clean the cover.

9.2 Repairs

Repair work on the device may only be performed by qualified and authorized personnel from SICK AG. Interruptions or modifications to the device by the customer will invalidate any warranty claims against SICK AG.

9.3 Returns

- ▶ Only send in devices after consulting with SICK Service.
- ▶ The device must be sent in the original packaging or an equivalent padded packaging.



NOTE

To enable efficient processing and allow us to determine the cause quickly, please include the following when making a return:

- Details of the contact person
- Description of the application
- Description of the fault that occurred

9.4 Disposal

If a device can no longer be used, dispose of it in an environmentally friendly manner in accordance with the applicable country-specific waste disposal regulations. Do not dispose of the product along with household waste.



NOTICE

Danger to the environment due to improper disposal of the device.

Disposing of devices improperly may cause damage to the environment.

Therefore, observe the following information:

- Always observe the national regulations on environmental protection.
- Separate the recyclable materials by type and place them in recycling containers.

10 Technical data



NOTE

The relevant online data sheet for your product, including technical data, dimensional drawing, and connection diagrams can be downloaded, saved, and printed from the Internet:

- www.sick.com/MRS1000

Please note: This documentation may contain further technical data.

10.1 Features

Measurement principle	HDDM+
Application	MRSxxxx-0xxxx: Indoor MRSxxxx-1xxxx: Outdoor
Light source	Infrared (wavelength 850 nm, max. output power 1.26 W, pulse duration 3.5 ns, average power 4.0 mW)
Laser class	Laser class 1 (EN/IEC 60825-1:2014, EN/IEC 60825-1:2007) Complies with 21 CFR 1040.10 and 1040.11 except for deviations pursuant to Laser Notice No. 50, dated June 24, 2007.
Horizontal aperture angle	275°
Vertical aperture angle	7.5° (over 4 measurement levels)
Scan field flatness	Conical error: ± 0.6° Tilt: ± 0.6°
Scanning frequency	50 Hz, 4x 12.5 Hz
Angular resolution	0.25°, 0.125° (interlaced mode), 0.0625° (interlaced mode)
Heating	self-heating
Working range	0.2 m ... 64 m
Scanning range with 10% remission	16 m
Scanning range with 90% remission	30 m
Spot divergence	10.4 mrad x 8.7 mrad
Light spot size at front screen	7 mm rounded
Number of echoes evaluated	3

Working range diagram

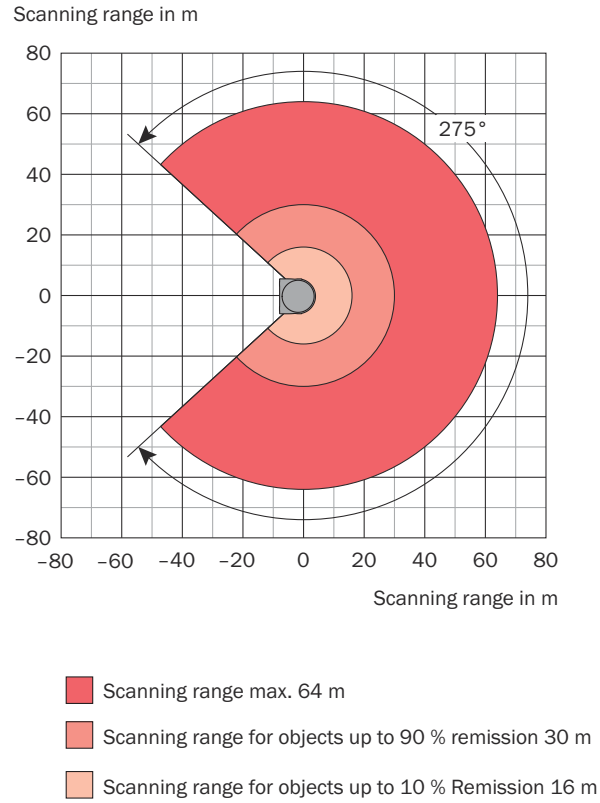

Figure 42: Working area diagram, top view

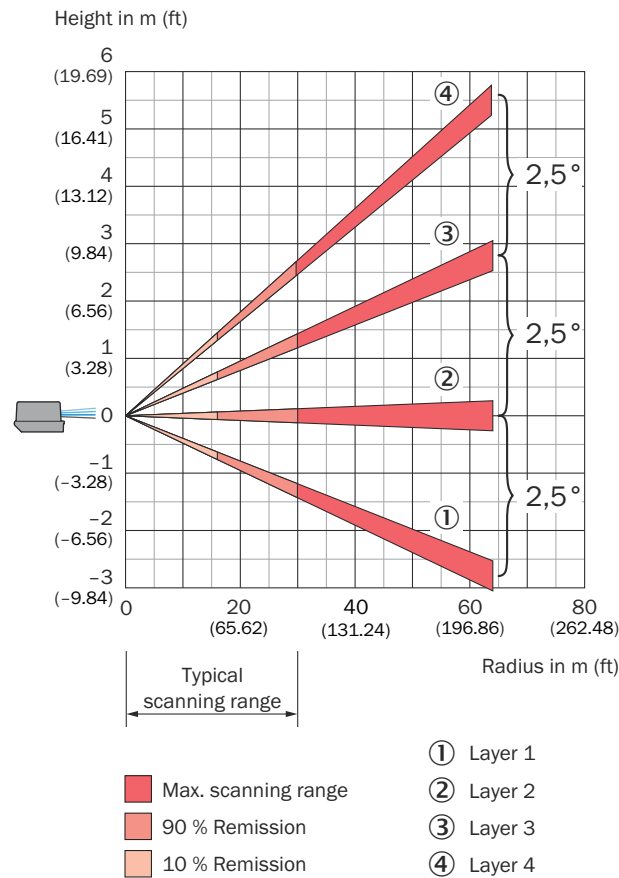

Figure 43: Working area diagram, side view

10.2 Mechanics/electronics

Connection type	3 x M12 round connectors with swivel connector
Supply voltage	10 V DC ... 30 V DC
Permissible residual ripple	±5%
Power consumption	$P_{typ} = 13 \text{ W}$ $P_{start} = 30 \text{ W}$ for 1 s (motor start-up) $P_{max} = 37 \text{ W}$ (with full specified current at all outputs)
Housing	ALSi12 Optics cover: PC
Housing color	MRSxxxx-xxxx0: Light blue(RAL 5012) MRSxxxx-xxxx1: Gray (RAL 7042)
Enclosure rating	MRSxxxx-0xxxx (indoor): IP65 (IEC 60529:1989+AMD1:1999+AMD2:2013) MRSxxxx-1xxxx (outdoor): IP65 / IP67 (IEC 60529:1989+AMD1:1999+AMD2:2013)
Protection class	III (IEC 61140:2016-11)
Electrical safety	IEC 61010-1:2010-06
Weight	1.2 kg
Dimensions (L x W x H)	151.9 mm x 150 mm x 92.5 mm
Encoder input frequency	not available
Maximum output current	max. 100 mA per output

1) e.g., 30 V*100 mA = 3 W

10.3 Dimensional drawing

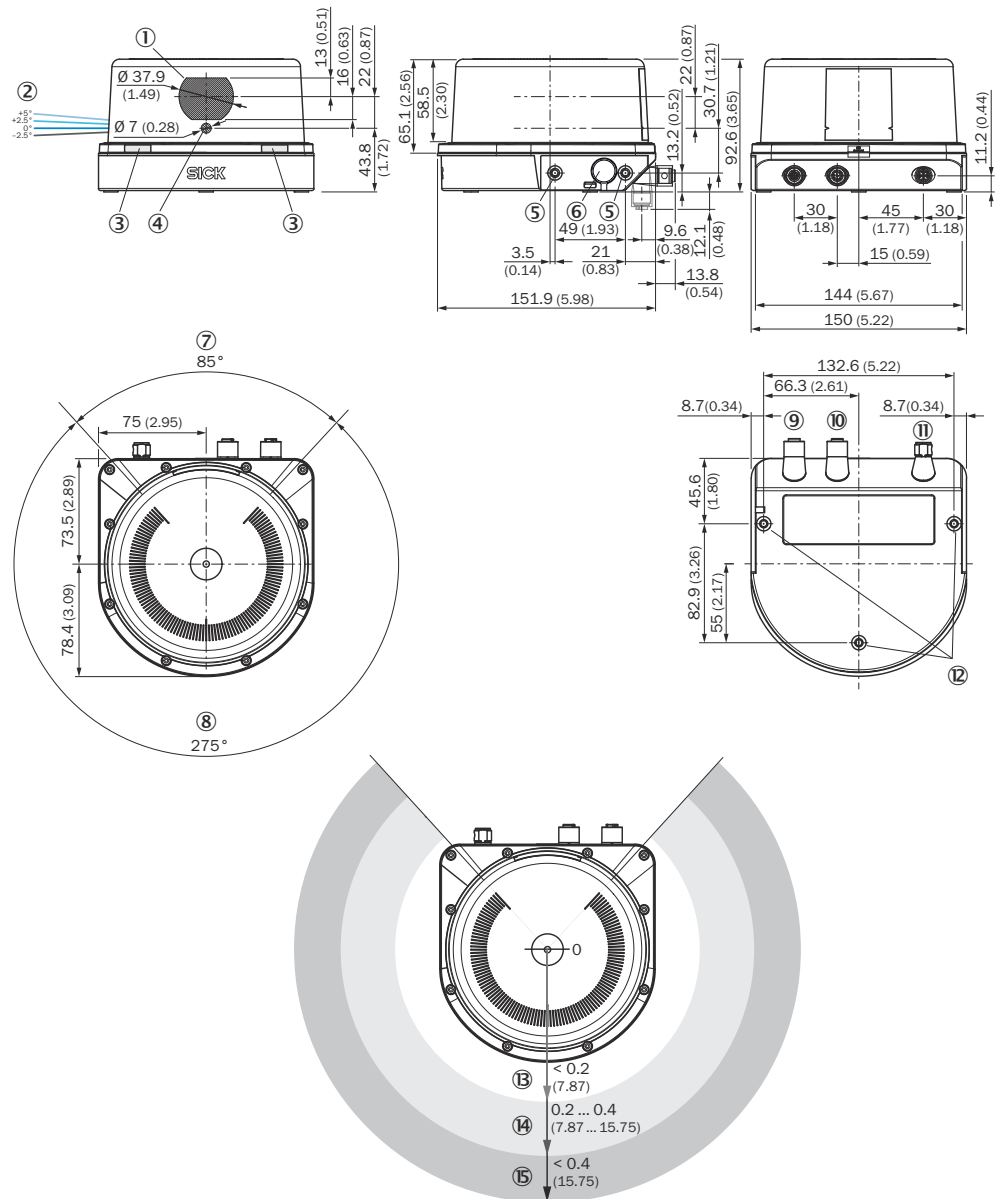

Figure 44: MRS1000 device structure and dimensions, dimensions in mm

- ① Receiver
- ② Laser aperture angle, layers 1 to 4
- ③ Status LEDs
- ④ Sender
- ⑤ M5x7.5 fixing holes
- ⑥ Pressure compensation element
- ⑦ Blind spot
- ⑧ Field of view
- ⑨ Ethernet connection
- ⑩ I/O connection
- ⑪ PWR connection (supply voltage)
- ⑫ M5x7.5 fixing holes
- ⑬ < 0.2 (7.87)
- ⑭ 0.2 ... 0.4 (7.87 ... 15.75)
- ⑮ < 0.4 (15.75)

- ⑭ Detection area
- ≙ Measuring range

10.4 Performance

Scan/frame rate	55000 ... 165000 measuring points/second
Response time	typically 20 ms (4 layers), typically 80 ms (1 layer) min. 7 ms, max. 84 ms + 1 scan
Systematic error	± 60 mm Temperature drift: Typically ± 0.5 mm/K
Statistical error	≤ 30 mm
Integrated application	Integrated field evaluation with flexible fields on 4 levels, data output
Number of field sets	Up to 64 fields
Simultaneous analysis cases	Up to 16 analyses
Filters	Fog filter, particle filter, average filter, median filter, ground reference evaluation, edge filter, echo filter

1) Depends on the object size and selected filter settings.

10.5 Interfaces

Ethernet	✓, TCP/ IP, UDP/ IP Function: HOST, OPC, NTP Measured data output (distance, RSSI) Data transmission rate: 10/100 Mbit/s
digital inputs/outputs	I/O (8 (multiport))
Output data	Contamination indication, IMU (secondary sensor data)
Optical indicators	2 LEDs
Configuration software	SOPAS ET, web server (display)

10.6 Ambient data

Object remission	2% ... > 1,000% (reflector)
Electromagnetic compatibility (EMC)	EN 61000-6-2:2005 EN 61000-6-3:2007+A1:2011
Vibration resistance	EN 60068-2-6:2007
Shock resistance	EN 60068-2-27:2008
Ambient operating temperature	MRSxxx-0xxxx: -10 °C ... +50 °C MRSxxx-1xxxx: -30 °C ... +50 °C
Storage temperature	-40 °C ... +75 °C
Operating and storage air humidity	Max 90% air humidity (non-condensing)
Ambient light immunity	80 klx

11 Accessories



NOTE

Accessories and where applicable mounting information can be found online at:

- www.sick.com/MRS1000
-

Support Portal



NOTE

In the SICK Support Portal (supportportal.sick.com, registration required) you will find, besides useful service and support information for your product, further detailed information on the available accessories and their use.

12 Annex

12.1 EU declaration of conformity/Certificates

The EU declaration of conformity and other certificates can be downloaded from the Internet at:

- www.sick.com/MRS1000

12.2 Licenses

SICK verwendet Open-Source-Software, die von den Rechteinhabern unter einer freien Lizenz veröffentlicht wird. Unter anderem werden folgende Lizenztypen verwendet: GNU General Public License (GPL Version 2, GPL Version 3), GNU Lesser General Public License (LGPL), MIT-Lizenz, zlib-Lizenz und von der BSD-Lizenz abgeleitete Lizenzen.

This program is provided for general use without warranty of any kind. This warranty disclaimer also extends to the implicit assurance of marketability or suitability of the program for a particular purpose.

More details can be found in the GNU General Public License.

For license texts see www.sick.com/licensetexts.

Printed copies of the license texts are also available on request.

12.3 Cybersecurity

To protect against cybersecurity threats, it is necessary to continuously monitor and maintain a comprehensive and holistic cybersecurity concept. A suitable concept comprises organizational, technical, procedural, electronic, and physical levels of defense and provides suitable measures for different types of risks. SICK's products and solutions must be viewed as a component of this concept.

Information on Cybersecurity can be found at: www.sick.com/psirt.

12.4 Configuration without computer

12.4.1 Field evaluation

Configuration is performed by teaching in (EasyTeach) of the surrounding contour in order to automatically generate a field with any shape, including more complex shapes. In the as-delivered configuration, the teach-in phase is activated and deactivated using the wiring for input IN4.

Preparing EasyTeach

- Remove all objects that will not permanently be in the field of view in monitoring mode later on.
- Distance yourself sufficiently from the device during the teach-in phase and do not enter the monitored area, so that you are not detected as part of the field contour.

Teaching in the field contour

- The device forms the field from the surrounding contour with a negative offset of 100 mm.
- The field shape to be formed can be defined by pacing out the limits during the teach-in phase. It is important to make sure that the person can always be unequivocally detected.

- The device stores the shortest value measured during the teach-in phase as a field limit for each angle.
- Note: A parameter upload is required in order to display the newly taught-in field contour in SOPAS.

1. Install the device.
2. Carry out the EasyTeach wiring.

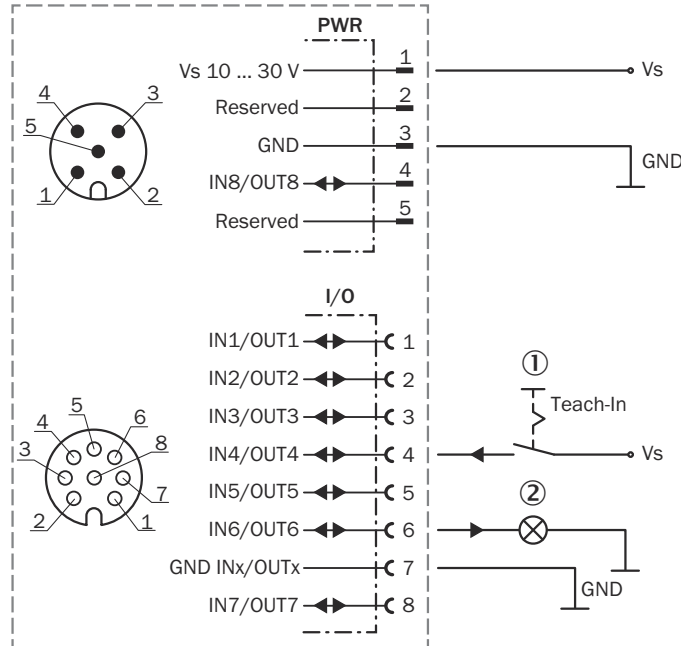

Figure 45: Wiring for EasyTeach (example)

- ① Teach-in via an external signaling device such as a pushbutton, at input IN4/OUT4 in this example.
 - ② Feedback for object detection; At output IN6/OUT6 in this example
3. Set the EasyTeach input signal to start the teach-in phase (active high).
 4. Define the field (e.g., using the existing surrounding contour or by pacing out the field).
 5. Remove the EasyTeach input signal to end the teach-in phase (active high).
 6. Thoroughly check correct detection of the field borders by performing a functional check in which For this purpose, deliberately induce object detections.

12.5 Configuration with computer

The SOPAS ET configuration software (from Version 3.3.3) is used as standard to display the surrounding contour (measuring line) recorded by the LiDAR sensor, as well as diagnostic information in the event of an error.

12.5.1 Output of measured values via terminal program

Example commands for output of measured values

If the LiDAR sensor receives one of the two example commands by telegram through the Ethernet interface, it will start the output of measured values through this data interface.

The detailed structure of the output telegram as well as the flow of requirements and outputs is described in the “Measurement output telegram” chapter in the Telegram listing publication (English, no. 8014631).

Request for output of measured values:

Table 16: Telegram structure: *sRN LMDscandata*

Telegram part	Description	Variable type	Length (byte)	Value range
Command type	Request (SOPAS read by name)	string	3	sRN
Command	Request data	string	11	LMDscandata

Table 17: Example: *sRN LMDscandata*

Telegram type	Command
ASCII	<STX>sRN{SPC}LMDscandata<ETX>
HEX	02 73 52 4E 20 4C 4D 44 73 63 61 6E 64 61 74 61 03
Binary	02 02 02 02 00 00 00 0F 73 52 4E 20 4C 4D 44 73 63 61 6E 64 61 74 61 05

Request for continuous output of measured values:Table 18: Telegram structure: *sEN LMDscandata* measurement start/stop

Telegram part	Description	Variable type	Length (byte)	Value range
Command type	Request (SOPAS event by name)	string	3	sEN
Command	Request data	string	11	LMDscandata
StartStop measurement		Enum8	1	0: Stop output of measured values 1: Start output of measured values

Table 19: Example: *sEN LMDscandata*

Telegram type	Command
ASCII	<STX>sEN{SPC}LMDscandata{SPC}1<ETX>
HEX	02 73 45 4E 20 4C 4D 44 73 63 61 6E 64 61 74 61 20 31 03
Binary	02 02 02 02 00 00 00 11 73 45 4E 20 4C 4D 44 73 63 61 6E 64 61 74 61 20 01 33

Note:

For the content of the response telegram for the measured value request, see the telegram listing (no. 8014631) under Send Data Permanently in Chapter 4. The telegram consists of one part with information on the configuration of the device and the time stamp, one part with measured data, and a status part with information on the device status and the statuses of the inputs/outputs.

After starting the measurement mode, the device needs some time to reach status 1 ("ready"). You should therefore query the status of the device using the **sRN SCdevicestate** telegram.

Then request measured data via telegram at the data interface from which you want to receive measured data. This can be achieved in two ways:

- The request of exactly one measured value with the **sRN LMDscandata** telegram – the last measured scan is transmitted.
- Continuous request of measured data with the **sEN LMDscandata 1** telegram – measured data is transmitted until the output of measured values is stopped with the **sEN LMDscandata 0** telegram.

Activating the output of the measured values in SOPAS on a test basis:

1. Start the terminal emulator: **Tools** menu > **Terminal**.
2. In the dialog window in the **Connections** menu, select the **Create new connection** function.

3. In the connection wizard, select the communication interface (**Ethernet**) and connection settings (default IP address: 192.168.0.1) and establish the connection (**Finish** button).
4. Enter in the input line one of the two example telegrams from the annex as they appear (automatically framed by **STX** and **ETX** when sending in the default setting). Pay attention to blank characters in the string.
5. Use the  button to transmit the telegram to the LiDAR sensor.
- ✓ The LiDAR sensor responds by providing the data as a one-off or continuously in the display area of the terminal emulator. The data is output in the following order: Layer 2, 3, 1, 4 (see "Features", page 51 "Working range diagram, side view").

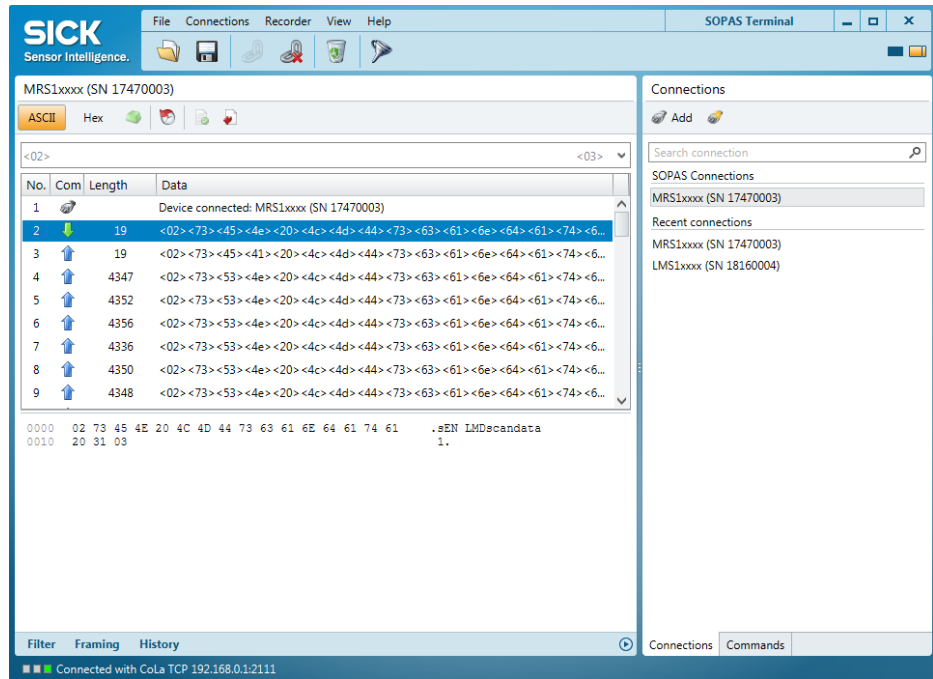

Data output format of the measured values

The data output format per scan is comprised of the configuration information, measured values, radial distance, RSSI, layer assignment, device and status information, and time stamp.

In the default settings, the distance is output as a measured value (in mm).

To output the reflectance values in the telegram: Open the device window (**Device> Open** menu) and, in the **Distance measurement** view, select the **RSSI** check box under **Output data format**.

12.5.2 Measured value display and configuration via start window

- ▶ Open start window: **Device> Open** menu.
- ✓ The **Start** view with information on the device, device status, and the graphic scan display opens.

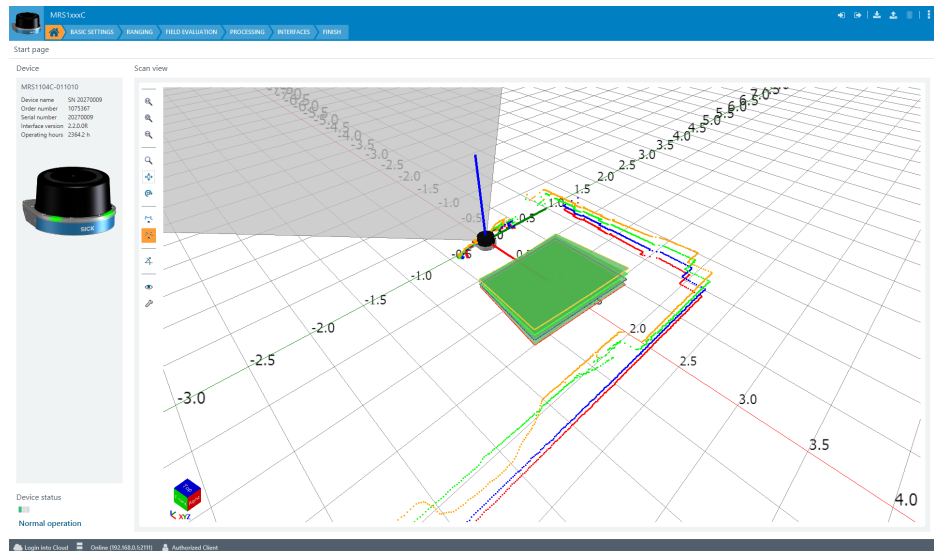



Figure 46: SOPAS ET: Start window

12.5.3 Selecting the application

1. Open the **Application** view.
2. Select **Field evaluation** or **Measurement data output**.

12.5.4 Field evaluation

Creating a new evaluation

- ▶ Click the  button.

Entering evaluation parameters

- ▶ Click the  button and enter evaluation parameters.

Inserting field points

1. Click the  button.
2. Insert field points by clicking.
3. Double-click to close the field.

Editing field points

The Edit field points tool () can be used to customize the field geometry with the assistance of the mouse pointer. Alternatively, the field vertices can also be customized by entering the coordinate values in the Field coordinates mask.

Function	Procedure
Scale field	Drag square red handle.
Rotate field	Drag round black handle.
Customize field shape	Drag square green handle.
Add field vertices	Double-click in required position.
Remove field vertex	Click to select the square green handle and press the [del] key.
Delete field	Press the [del] key without first selecting a green handle.

Important information about fields

It is possible to define up to 64 fields and 16 evaluations.

In the default settings, fields are projected into all levels. If you do not want this to happen, you can deactivate the option in Field properties.

12.5.5 Configuring interfaces

Settings for using the multifunctional I/Os can be made in the **Interfaces** area. In addition, the current status and saved function of the input/output are displayed.



The multifunctional I/Os are switchable and can therefore each be used as either a digital input or output. The factory settings are as follows: multifunctional I/Os 1-4 preset as inputs and multifunctional I/Os 5-8 preset as outputs.

The inputs may switch on, switch off, and switch over analysis cases, for example. The inputs can also be used to activate other functions, such as EasyTeach or measurement data output triggering.

The outputs can be used as digital switching outputs, for example to ground (PNP) (depending on the device type). For each output, it is necessary to define whether it is to be switched by the field evaluation application or by means of SOPAS ET telegrams, or whether it is being used to signal device readiness. If the field evaluation application is being used to switch an output, the sensor may signal evaluation field breaches or contour breaches. In SOPAS ET, you can configure which evaluation affects which output.

12.5.6 Some useful functions

 button: Resets scan display to default view.

 And  button: Displays measured values as points or lines.

 button: Freely rotates scan display.

 perspective cube: Changes perspective of the laser scanner.

12.5.7 Configuring the device

1. Set the desired configuration data in the **Basic settings** and **Interfaces** views (buttons under the menu bar).
2. Finally, permanently save the configuration in the **Finish** view:
 - o Click the **Save permanent** button to save the parameter set in the device.
 - o Click the **Export...** button to save the parameter set on the computer.

Australia

Phone +61 (3) 9457 0600
1800 33 48 02 – tollfree
E-Mail sales@sick.com.au

Austria

Phone +43 (0) 2236 62288-0
E-Mail office@sick.at

Belgium/Luxembourg

Phone +32 (0) 2 466 55 66
E-Mail info@sick.be

Brazil

Phone +55 11 3215-4900
E-Mail comercial@sick.com.br

Canada

Phone +1 905.771.1444
E-Mail cs.canada@sick.com

Czech Republic

Phone +420 234 719 500
E-Mail sick@sick.cz

Chile

Phone +56 (2) 2274 7430
E-Mail chile@sick.com

China

Phone +86 20 2882 3600
E-Mail info.china@sick.net.cn

Denmark

Phone +45 45 82 64 00
E-Mail sick@sick.dk

Finland

Phone +358-9-25 15 800
E-Mail sick@sick.fi

France

Phone +33 1 64 62 35 00
E-Mail info@sick.fr

Germany

Phone +49 (0) 2 11 53 010
E-Mail info@sick.de

Greece

Phone +30 210 6825100
E-Mail office@sick.com.gr

Hong Kong

Phone +852 2153 6300
E-Mail ghk@sick.com.hk

Hungary

Phone +36 1 371 2680
E-Mail ertesites@sick.hu

India

Phone +91-22-6119 8900
E-Mail info@sick-india.com

Israel

Phone +972 97110 11
E-Mail info@sick-sensors.com

Italy

Phone +39 02 27 43 41
E-Mail info@sick.it

Japan

Phone +81 3 5309 2112
E-Mail support@sick.jp

Malaysia

Phone +603-8080 7425
E-Mail enquiry.my@sick.com

Mexico

Phone +52 (472) 748 9451
E-Mail mexico@sick.com

Netherlands

Phone +31 (0) 30 229 25 44
E-Mail info@sick.nl

New Zealand

Phone +64 9 415 0459
0800 222 278 – tollfree
E-Mail sales@sick.co.nz

Norway

Phone +47 67 81 50 00
E-Mail sick@sick.no

Poland

Phone +48 22 539 41 00
E-Mail info@sick.pl

Romania

Phone +40 356-17 11 20
E-Mail office@sick.ro

Russia

Phone +7 495 283 09 90
E-Mail info@sick.ru

Singapore

Phone +65 6744 3732
E-Mail sales.gsg@sick.com

Slovakia

Phone +421 482 901 201
E-Mail mail@sick-sk.sk

Slovenia

Phone +386 591 78849
E-Mail office@sick.si

South Africa

Phone +27 10 060 0550
E-Mail info@sickautomation.co.za

South Korea

Phone +82 2 786 6321/4
E-Mail infokorea@sick.com

Spain

Phone +34 93 480 31 00
E-Mail info@sick.es

Sweden

Phone +46 10 110 10 00
E-Mail info@sick.se

Switzerland

Phone +41 41 619 29 39
E-Mail contact@sick.ch

Taiwan

Phone +886-2-2375-6288
E-Mail sales@sick.com.tw

Thailand

Phone +66 2 645 0009
E-Mail marcom.th@sick.com

Turkey

Phone +90 (216) 528 50 00
E-Mail info@sick.com.tr

United Arab Emirates

Phone +971 (0) 4 88 65 878
E-Mail contact@sick.ae

United Kingdom

Phone +44 (0)17278 31121
E-Mail info@sick.co.uk

USA

Phone +1 800.325.7425
E-Mail info@sick.com

Vietnam

Phone +65 6744 3732
E-Mail sales.gsg@sick.com

Detailed addresses and further locations at www.sick.com