

Type 8691 REV.2

Control Head



Operating Instructions

We reserve the right to make technical changes without notice.
Technische Änderungen vorbehalten.
Sous réserve de modifications techniques.

© Bürkert Werke GmbH & Co. KG, 2017 - 2021

Operating Instructions 2111/03_EU-EN_00810626 / Original DE

Control head Type 8691 REV.2

TABLE OF CONTENTS

1	ABOUT THESE INSTRUCTIONS	7
1.1	Symbols.....	7
1.2	Definition of terms.....	7
2	INTENDED USE	8
3	BASIC SAFETY INSTRUCTIONS	9
4	GENERAL INFORMATION.....	10
4.1	Contact address.....	10
4.2	Warranty	10
4.3	Information on the Internet.....	10
4.4	Trademarks.....	10
5	PRODUCT DESCRIPTION.....	11
5.1	Structure.....	11
5.1.1	Structure, integrated pilot air duct (21xx, Element)	11
5.1.2	Structure, external pilot air duct (20xx, Classic)	11
5.1.3	Variants	12
5.2	Function.....	12
6	TECHNICAL DATA	13
6.1	Conformity.....	13
6.2	Standards	13
6.3	Approvals	13
6.4	Type label	14
6.4.1	Type label standard	14
6.4.2	UL type label.....	14
6.4.3	UL additional label.....	14

6.5	Operating conditions	15
6.5.1	Fluidic data	15
6.5.2	Electrical data	15
6.5.2.1	Electrical data, IO-Link	15
6.5.2.2	Electrical data, bÜS.....	16
6.6	Mechanical data.....	16
6.6.1	Safety end positions	16
7	MECHANICAL INSTALLATION	17
7.1	Safety instructions	17
7.2	Installing devices with integrated pilot air duct (21xx, Element)	17
7.3	Installing devices with external control air duct (20xx, Classic)	20
7.4	Aligning (turning) the device and position of connections.....	24
7.4.1	Turning the actuator, devices with hexnut	25
7.4.2	Turning the actuator, devices without hexnut.....	26
7.4.3	Turning the device	27
8	PNEUMATIC INSTALLATION.....	28
8.1	Safety instructions	28
8.2	Connecting the device pneumatically.....	28
9	ELECTRICAL INSTALLATION.....	29
9.1	Safety instructions for electrical installation.....	29
9.2	Connecting the device electrically, IO-Link.....	29
9.3	Connecting the device electrically, bÜS	30
10	START-UP	31
10.1	Teach function: Determine end positions and save these, REV.2	31
10.1.1	Automatic teach function.....	31
10.1.2	Manual teach function	33
10.2	Setting with Bürkert Communicator.....	35
10.2.1	Connecting IO-Link device with Bürkert Communicator.....	35
10.2.2	Connecting bÜS device with Bürkert Communicator	36

10.3	IO-Link	36
10.3.1	Information, IO-Link	36
10.3.2	Technical specifications, IO-Link	36
10.3.3	Interfaces, IO-Link	37
10.3.4	Configuration of the fieldbus	37
10.4	büS	38
10.4.1	Information, büS	38
10.4.2	Interfaces, büS	38
10.4.3	Configuration of the fieldbus	38
11	OPERATION	39
11.1	Display device status, IO-Link and büS	39
11.1.1	Pilot valve LED	40
11.1.2	Status LED, green and red	40
11.1.3	Device status display	40
11.1.3.1	Valve mode	41
11.1.3.2	Valve mode + errors	41
11.1.3.3	Valve mode + errors + warnings	41
11.1.3.4	NAMUR mode	43
11.2	Switching the device manually with pilot valve	43
12	MAINTENANCE	45
12.1	Servicing the air intake filter	45
13	DEINSTALLATION	46
13.1	Safety instructions deinstallation	46
13.2	Deinstallation	47
14	SPARE PARTS, ACCESSORIES	48
14.1	Communications software	48
15	TRANSPORTATION, STORAGE, DISPOSAL	49

1 ABOUT THESE INSTRUCTIONS

The operating instructions describe the entire life cycle of the device.

→ Keep these instructions ready to hand at the operation site.

Important safety information.

- ▶ Carefully read these instructions.
- ▶ Observe in particular the safety instructions, intended use and operating conditions.
- ▶ Persons, who work on the device, must read and understand these instructions.

1.1 Symbols



DANGER

Warns of an immediate danger.

- ▶ Failure to observe the warning will result in a fatal or serious injury.



WARNING

Warns of a potentially dangerous situation.

- ▶ Failure to observe the warning may result a fatal or serious injury.



CAUTION

Warns of a possible danger.

- ▶ Failure to observe the warning may result in moderate or minor injuries.

NOTE

Warns of damage to property.

- ▶ Failure to observe the warning may result in damage to device or system.



Indicates important additional information, tips and recommendations.



Refers to information in these operating instructions or in other documentation.

- ▶ Designates an instruction for risk prevention.

→ Designates a procedure which you must carry out.



Indicates a result.

1.2 Definition of terms

In these instructions the term “device” denotes the following device types:

Control head Type 8691 REV.2

The term “bÜS” (Bürkert system bus) used in this instruction stands for the communication bus developed by Bürkert and based on the CANopen protocol.

2 INTENDED USE

The control head Type 8691 REV.2 is designed to be mounted on pneumatic actuators of process valves for the control of media. The permitted fluid media are listed in the technical data.

- ▶ Use the device for its intended purpose only. Non-intended use of the device may be dangerous to people, nearby equipment and the environment.
- ▶ Correct transportation, correct storage as well as correct installation, commissioning, operation and maintenance are essential for reliable and problem-free operation.
- ▶ When using the device, observe the permitted data, operating conditions and application conditions. This information can be found in the contractual documents, the operating instructions and on the type label.
- ▶ Use the device only in conjunction with third-party devices and components recommended and authorized by Bürkert.
- ▶ Do not use the device outdoors without protection from the weather.
- ▶ In areas at risk of explosion, only use devices approved for use in those areas. These devices are labeled with a separate Ex type label. For such use, note the information provided on the separate Ex type label and the additional explosion-related information or separate explosion-related operating instructions.

3 BASIC SAFETY INSTRUCTIONS

These safety instructions do not consider any contingencies or incidents which occur during installation, operation and maintenance.

The operator is responsible for observing the location-specific safety regulations, also with reference to the personnel.

DANGER

Risk of injury from high pressure and discharge of medium.

- ▶ Before working on the device or system, switch off the pressure. Vent or drain lines.

DANGER

Risk of injury from electric shock.

- ▶ Before working on the device or system, switch off the power supply. Secure against reactivation.
- ▶ Observe applicable accident prevention and safety regulations for electrical equipment.



To prevent injury, ensure the following:

- ▶ Secure device or system to prevent unintentional activation.
- ▶ Only trained technicians may perform installation and maintenance work.
- ▶ Perform installation and maintenance with suitable tools only.
- ▶ Do not make any changes to the device and do not subject it to mechanical stress.
- ▶ Operate the device only in perfect state and in consideration of the operating instructions.
- ▶ Observe the general rules of technology.
- ▶ Install the device according to the regulations applicable in the respective country.
- ▶ Do not feed corrosive or flammable media into the device connections.
- ▶ Do not feed any fluids into the connections of the device.
- ▶ After the process is interrupted, restart in a controlled manner. Observe sequence:
 1. Connect electrical or pneumatic power supply.
 2. Charge the device with medium.
- ▶ Observe intended use.

4 GENERAL INFORMATION

4.1 Contact address

Germany

Bürkert Fluid Control System
Sales Center
Chr.-Bürkert-Str. 13-17
D-74653 Ingelfingen
Tel. + 49 (0) 7940 - 10 91 111
Fax + 49 (0) 7940 - 10 91 448
E-mail: info@burkert.com

International

Contact addresses can be found on the final pages of the printed operating instructions.

Also in the internet at:

www.burkert.com

4.2 Warranty

The warranty is only valid if the device is used as intended in accordance with the specified application conditions.

4.3 Information on the Internet

The operating instructions and data sheets for Bürkert products can be found on the Internet at:

www.burkert.com

4.4 Trademarks

The brands listed below are trademarks of the corresponding companies / associations or organizations.

Loctite Henkel Loctite Deutschland GmbH

5 PRODUCT DESCRIPTION

5.1 Structure

The modular design of the device supports various configurations and variants.

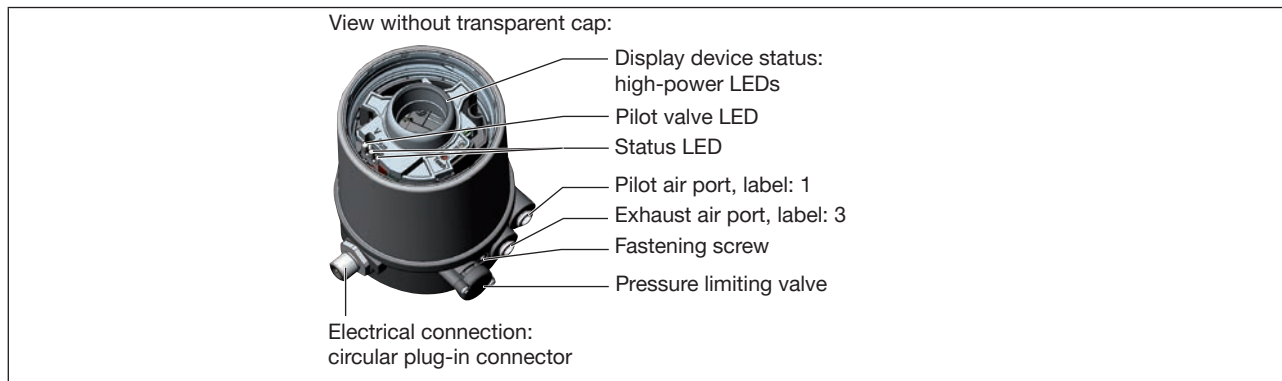

Figure 1: Structure

5.1.1 Structure, integrated pilot air duct (21xx, Element)

The structure with integrated pilot air duct is optimized for mounting on process valves of the 21xx series (Element).

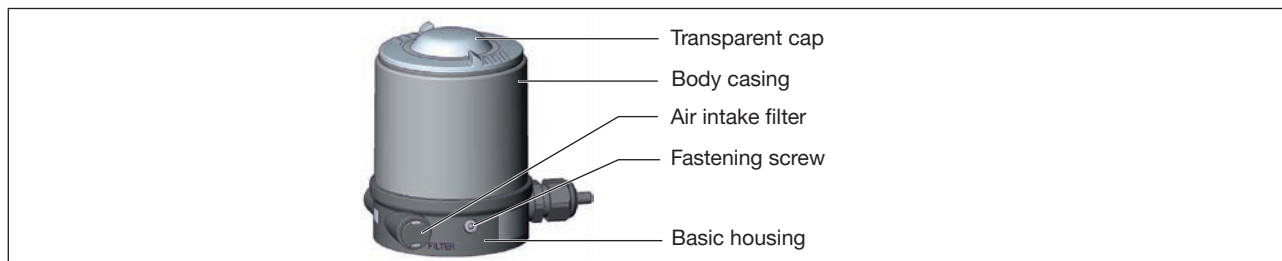

Figure 2: Structure, integrated pilot air duct

5.1.2 Structure, external pilot air duct (20xx, Classic)

The structure with external pilot air duct is optimized for mounting on process valves of the 20xx series (Classic).

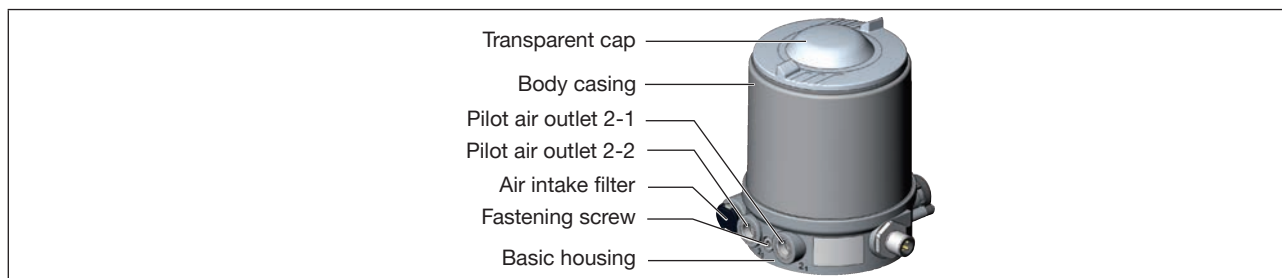

Figure 3: Structure, external pilot air duct

So that the pilot air can be externally connected to the actuator, this structure has a different basic housing.

5.1.3 Variants

Communication possible via:

- IO-Link
- büS

5.2 Function

This device is capable of controlling single-acting and double-acting process valves.

The pilot valves can be manually overridden.

An analog, inductive sensor element provides feedback about end positions being reached. The teach function is used for configuration.

Colored LEDs indicate the device status.

6 TECHNICAL DATA

6.1 Conformity

The device conforms to the EU directives as per the EU Declaration of Conformity (if applicable).

6.2 Standards

The applied standards, which are used to demonstrate conformity with the EU Directives, are listed in the EU type examination certificate and/or the EU Declaration of Conformity (if applicable).

6.3 Approvals

The product is approved for use in zone 2 and 22 in accordance with ATEX directive 2014/34/EU category 3GD.



Observe instructions on operation in the explosion-risk area. See additional explosion-related information.

The product is cULus approved. Instructions on operation in the UL area see chapter “Electrical data”.

6.4 Type label

6.4.1 Type label standard

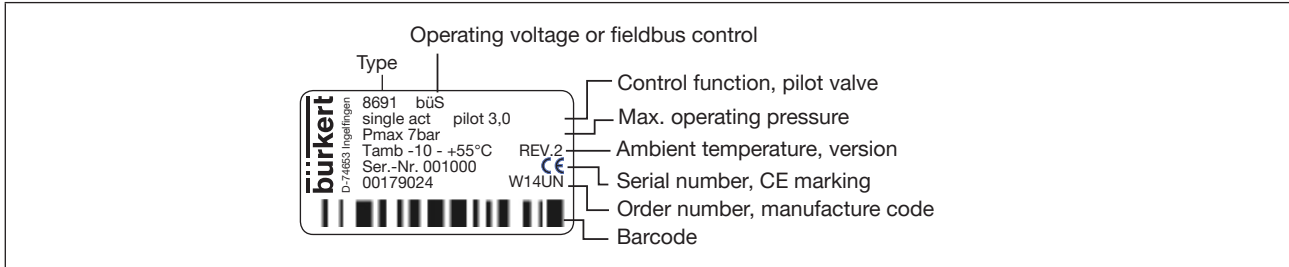

Figure 4: Type label standard (example)

6.4.2 UL type label

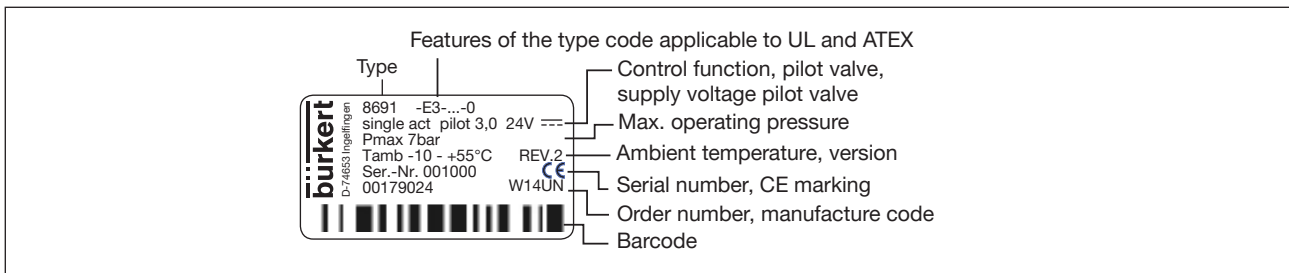

Figure 5: UL type label (example)

6.4.3 UL additional label

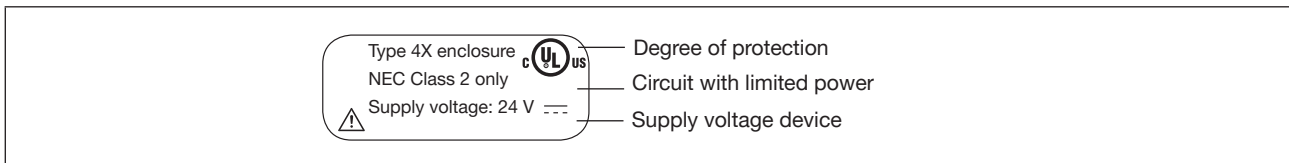

Figure 6: UL additional label (example)

6.5 Operating conditions

Ambient temperature	See type label
Degree of protection	
Evaluated by manufacturer:	IP65, IP67 as per EN 60529*
Evaluated by UL:	UL type 4x Rating, indoor only*
Operating altitude	up to 2000 m above sea level
Relative air humidity	max. 90% at 55 °C (non condensing)

6.5.1 Fluidic data

Control medium	Neutral gases, air Quality classes as per ISO 8573-1
Dust content Class 7	Max. particle size 40 µm, max. particle density 10 mg/m ³
Water content class 3	Max. pressure dew point -20°C or min. 10°C below lowest operating temperature
Oil content Class X	Max. 25 mg/m ³
Pressure range	3–7 bar
Temperature range	-10 to +50 °C
Pilot valve air flow rate	250 l _N / min (for aeration and deaeration) (Q _{Nn} - value according to definition for pressure drop from 7 to 6 bar absolute)
Connections	Internal thread G 1/8 "

6.5.2 Electrical data

NOTE

For variants with cULus approval, please note:

- ▶ Only use circuits of limited power as per UL NEC Class 2.

6.5.2.1 Electrical data, IO-Link

Protection class	3 as per DIN EN 61140 (VDE 0140-1)
Connection	Circular plug-in connector M12 x 1, 4-pin, Port Class A
Operating voltage	18–30 V DC (according to specification)
Max. current consumption	135 mA @18 V (incl. inrush current pilot valve for 200 ms)
Current consumption input during normal operation	110 mA @18 V
(after current reduction, pilot valve after 200 ms and 1 end position reached)	

* Only if cables, plugs and sockets have been connected correctly and in compliance with the exhaust air concept see chapter "Pneumatic installation".

6.5.2.2 Electrical data, bÜS

Protection class	3 as per DIN EN 61140 (VDE 0140-1)
Connection	Circular plug-in connector M12 x 1, 5-pin
Operating voltage	18–30 V DC (according to specification)
Max. current consumption	120 mA @18 V (incl. inrush current pilot valve for 200 ms)
Current consumption input during normal operation (after current reduction, pilot valve after 200 ms and 1 end position reached)	95 mA @18 V

6.6 Mechanical data

Dimensions	See data sheet
Body material	
exterior:	PPS, PC, VA
Seal material	
external:	EPDM
internal:	NBR
Stroke range of valve spindle	2–47 mm

6.6.1 Safety end positions

Safety end positions after failure of the electrical or pneumatic auxiliary power:

Actuator system	Designation	Safety end positions after failure of the auxiliary power	
		electrical	pneumatic
	single-acting control function A	down	down
	single-acting control function B	up	up
	double-acting control function I	down	not defined

Table 1: Safety end positions

7 MECHANICAL INSTALLATION

7.1 Safety instructions

DANGER

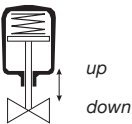
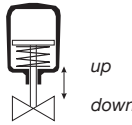
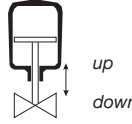
Risk of injury from high pressure and discharge of medium.

- ▶ Before working on the device or system, switch off the pressure. Vent or drain lines.

WARNING

Risk of injury from improper installation.

- ▶ Only trained technicians may perform installations.
- ▶ Perform installations with suitable tools only.

WARNING

Risk of injury due to unintentional activation and uncontrolled start-up of the system.

- ▶ Secure system against unintentional activation.
- ▶ Ensure that the system does not start up in an uncontrolled manner.

7.2 Installing devices with integrated pilot air duct (21xx, Element)

 Only for devices without preinstalled process valve.

Required attachment kit: ELEMENT Type 21xx

NOTE

Damage to the device and the drive when welding welded bodies.

Observe the following during installation on process valves with welded body:

- ▶ Observe the installation instructions for the operating manual of the process valve.
- ▶ Before installing the device, weld the process valve into the pipe system.

1. Installing the switch spindle

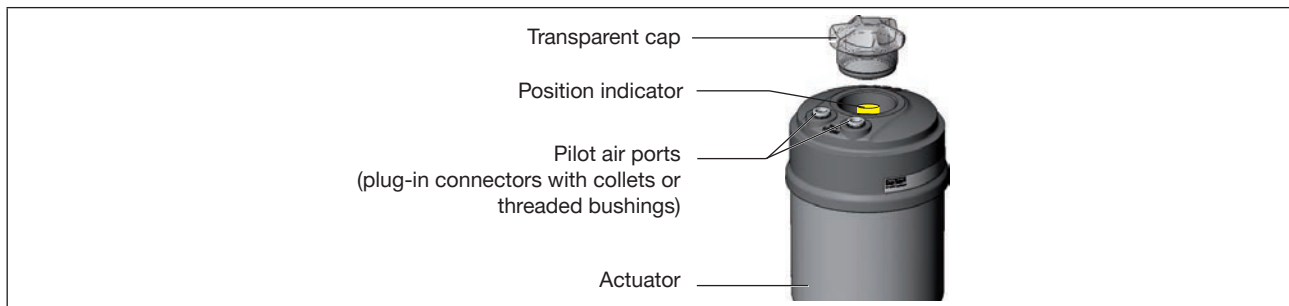

Figure 7: Installing the switch spindle (1), integrated pilot air duct

- Unscrew the transparent cap from the actuator.
- Unscrew position indicator from spindle extension.
- For variant with hose connector: remove the collets (white sleeves) from the pilot air ports.

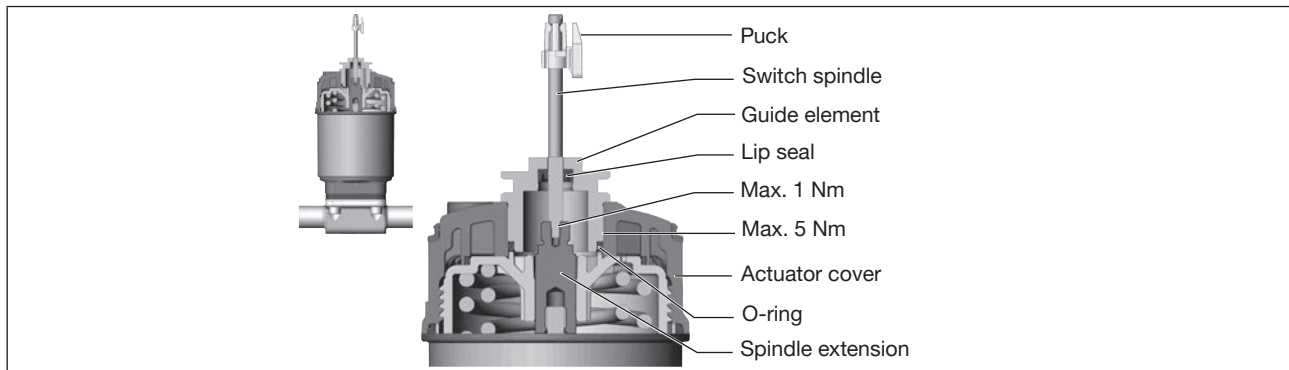

Figure 8: Installing the switch spindle (2), integrated pilot air duct

NOTE

Lip seal can be damaged if incorrectly installed.

The lip seal is pre-mounted in the guide element and must be "locked into position" in the undercut.

- ▶ When installing the switch spindle, do not damage the lip seal.

- Slide switch spindle through the guide element.

NOTE

Contamination of the lip seal due to screw locking paint.

- ▶ Do not apply any screw locking paint to the switch spindle.

- To secure the switch spindle, apply some screw locking paint (e.g. Loctite 290) in the threading of the spindle extension in the actuator.
- Check that the O-ring is in the correct position.
- Screw guide element in actuator cover (tightening torque: max. 5 Nm).
- Screw switch spindle onto the spindle extension. A slot is provided on the top side (tightening torque: max. 1 Nm).
- Push puck onto the switch spindle and lock into position.

2. Attaching the form seal

- Pull the form seal onto the actuator cover (smaller diameter points upwards).
- Check that the O-rings are correctly positioned in the pilot air ports.

! Before installing the device, remove the collets in the pilot air ports.

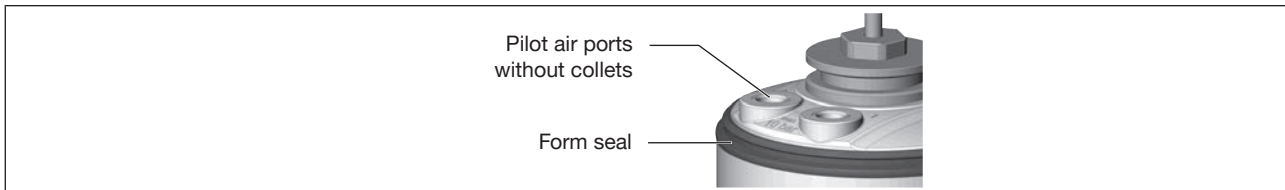

Figure 9: Attaching the form seal

3. Installing the device

NOTE

Damage or functional outage of the PCB

- ▶ Ensure that the puck lies flat in the guide rail.

- Align the puck and device so that:
 1. The puck rests in the guide rail of the device (see Fig. below).
 2. Find the connection pieces of the device into the pilot air ports of the actuator (see second Fig. below).

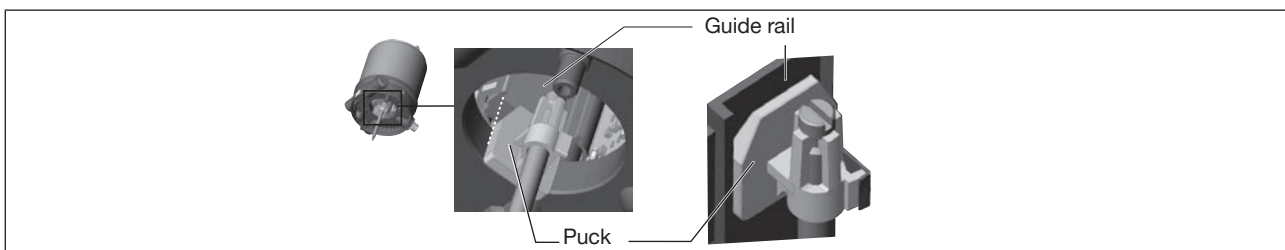

Figure 10: Aligning the puck

- Push the device without turning it onto the actuator until no gap is visible on the form seal.

NOTE

Damage or malfunction due to ingress of dirt or moisture.

To observe the degree of protection IP65 or IP67:

- ▶ Tighten fastening screws only with a tightening torque of max. 1.5 Nm.

- Attach device to the actuator using the two side fastening screws. In doing so, tighten the screws only hand-tight (max. torque: 1.5 Nm).

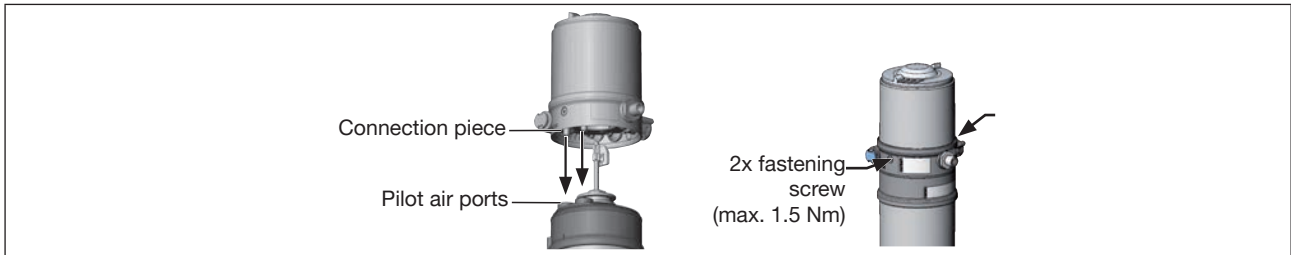

Figure 11: Installation

7.3 Installing devices with external control air duct (20xx, Classic)

! Only for devices without preinstalled process valve.

Required attachment kit: Classic Type 20xx for the corresponding variant

NOTE

Damage to the device and the drive when welding welded bodies.

Observe the following during installation on process valves with welded body:

- ▶ Observe the installation instructions for the operating manual of the process valve.
- ▶ Before installing the device, weld the process valve into the pipe system.

1. Installing switch spindle

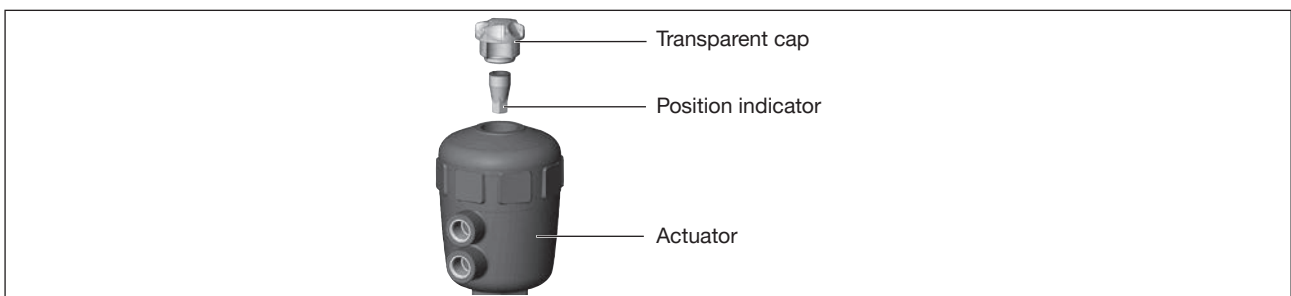

Figure 12: Installing the switch spindle (1), external pilot air duct

→ Unscrew the transparent cap from the actuator.

→ Unscrew the position indicator of the spindle with hex key.

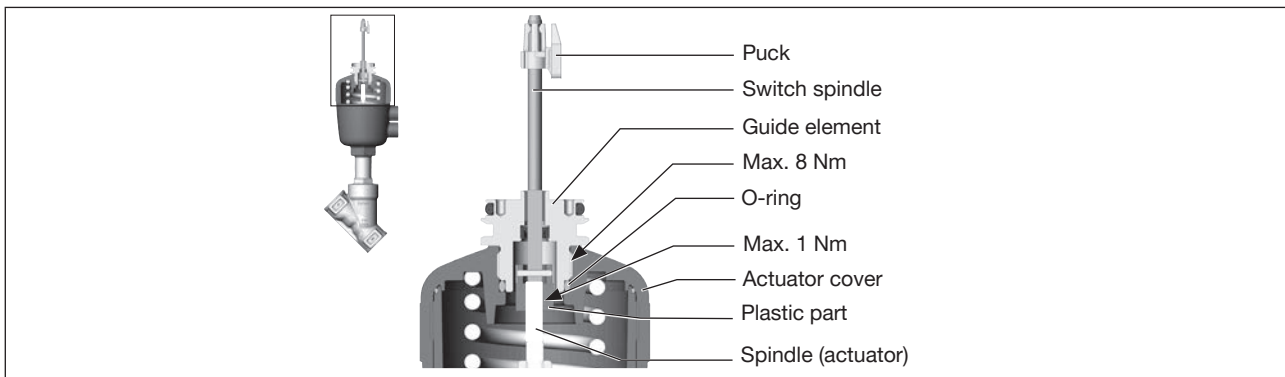

Figure 13: Installing the switch spindle (2), external pilot air duct

- Press O-ring down into the actuator cover.
- Manually screw the switch spindle (and the slipped over guide element) to the spindle of the actuator with the plastic part and do not tighten initially.
- Screw the guide element into the cover of the actuator with a face pin wrench* (tightening torque: max. 8 Nm).
- Tighten the switch spindle on the spindle of the actuator. A slot is provided on the top side (tightening torque: max. 1 Nm).
- Push puck onto the switch spindle and lock into position.

2. Installing the device

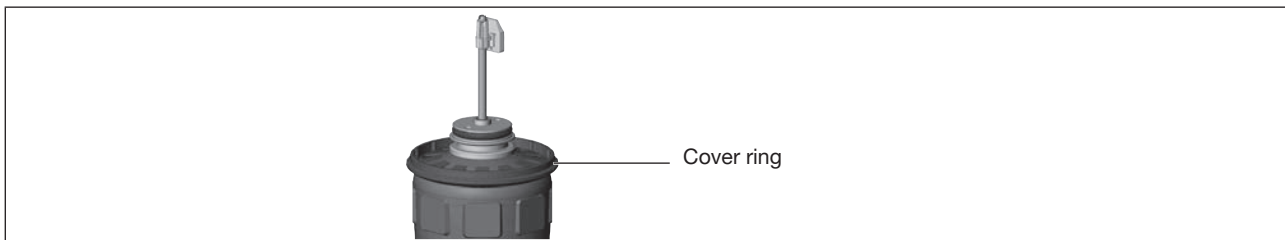

Figure 14: Attaching cover ring

- Wind cover ring onto actuator cover (only for actuator size $\varnothing 50$ and $\varnothing 63$).

NOTE

Damage or functional outage of the PCB

- ▶ Ensure that the puck lies flat in the guide rail.

- Align the puck and the device so that the puck rests in the guide rail of the device (see following figure).

* journal \varnothing : 3 mm; journal gap: 23.5 mm

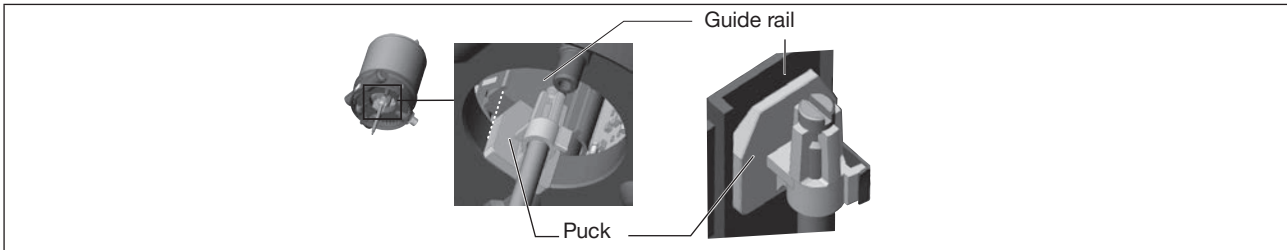

Figure 15: Aligning the puck

→ Press the device all the way down to the actuator and turn it into the required position.



Ensure that the pneumatic connections of the device and those of the valve actuator are situated preferably vertically one above the other (see Fig. below). For different positioning, longer hoses may be required than those supplied in the attachment kit.

NOTE

Damage or malfunction due to ingress of dirt or moisture.

To observe the degree of protection IP65 or IP67:

- ▶ Tighten fastening screws only with a tightening torque of max. 1.5 Nm.

→ Attach device to the actuator using the two side fastening screws. In doing so, tighten the screws only hand-tight (max. torque: 1.5 Nm).

3. Pneumatically connecting device and actuator

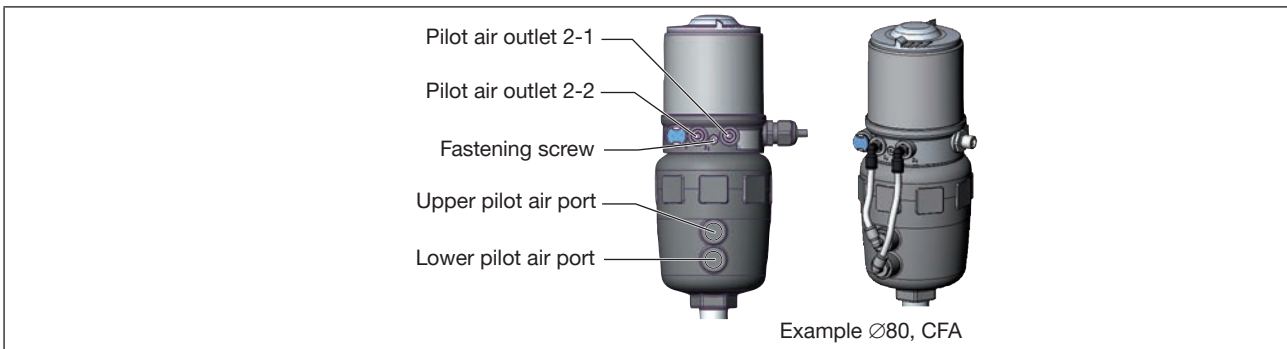

Figure 16: Pneumatically connecting device and actuator

→ Screw plug-in hose connector onto device and actuator.

→ Using the hoses supplied in the attachment kit, make the pneumatic connection between the device and actuator with the following table.

NOTE

Damage or malfunction due to ingress of dirt or moisture.

To observe the degree of protection IP65 or IP67:



- ▶ Only for CFA and CFB: Connect the pilot air outlet which is not required to the free pilot air port of the actuator or seal with a plug.

Control function A (CFA) Process valve closed in resting position (by spring force)				
Device	Pilot air outlet		or	
Actuator	Upper pilot air port			
	Lower pilot air port			
Control function B (CFB) Process valve open in resting position (by spring force)				
Device	Pilot air outlet		or	
Actuator	Upper pilot air port			
	Lower pilot air port			

Table 2: Pneumatically connecting device and actuator CFA and CFB

Control function I (CFI) Process valve closed in resting position				
Device	Pilot air outlet			
Actuator	Upper pilot air port			
	Lower pilot air port			
Control function I (CFI) Process valve open in resting position				
Device	Pilot air outlet			
Actuator	Upper pilot air port			
	Lower pilot air port			

Table 3: Pneumatically connecting device and actuator CFI

-  "In rest position" means that the pilot valves of the device are isolated and not actuated.
-  If the ambient air is humid, a hose can be connected between pilot air outlet 2₂ of the device and the unconnected pilot air port of the actuator for control function A and control function B. As a result, the spring chamber of the actuator is supplied with dry air from the pilot air outlet of the device.

7.4 Aligning (turning) the device and position of connections



Devices with integrated pilot air duct:

Alignment of device and position of connections is only possible with 2100, 2101 and 2106 process valves.

The device and position of the connections can be aligned by:

- turning the actuator



Devices with external pilot air duct:

The device and position of the connections can be aligned by:

- turning the actuator (only types 2000, 2002, 2006 and 2012)
- turning the device

7.4.1 Turning the actuator, devices with hexnut



The following description only applies for devices with hexnut on the actuator.

For devices without a hexnut on the actuator: refer to the section "Turning the actuator, devices without hexnut" in the operating instructions.

The position of the connections can be infinitely adjusted by rotating the actuator through 360°.

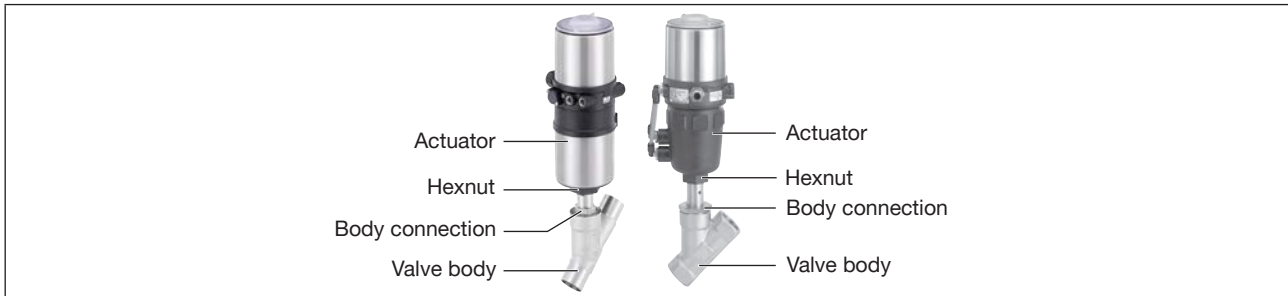

Figure 17: Turning the actuator (1)

→ Clamp the valve body into a holding device (only for valves not yet installed).

NOTE

Damage to the seat seal or the seat contour.

▶ When turning the actuator, the valve must be open.

→ For control function A and I*:

Apply compressed air to pilot air port 1.

→ Switching the device manually with pilot valve (see chapter).

→ Using a suitable open-end wrench, counter the wrench flat on the body connection.

→ Place a suitable open-end wrench on the hexagonal bolt of the actuator.



DANGER

Risk of injury from high pressure and discharge of medium.

If the direction of rotation is wrong, the body connection may become detached.

▶ Only turn the actuator in the prescribed direction.

→ Move the actuator to the required position by **turning it counter-clockwise** (viewed from below).

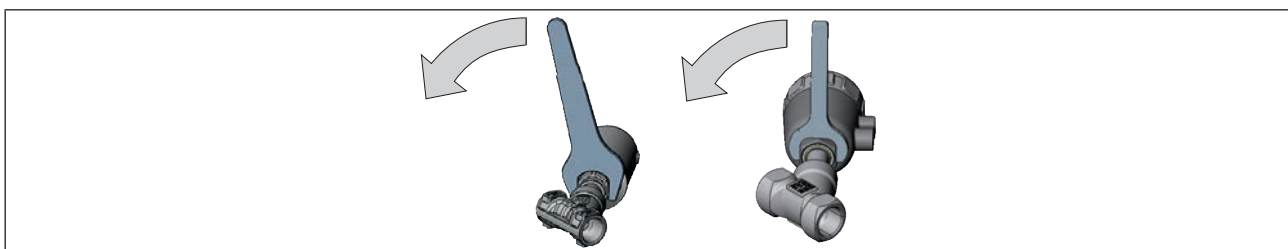

Figure 18: Turning the actuator (2)

* if variant exists

7.4.2 Turning the actuator, devices without hexnut

The position of the connections can be infinitely adjusted by rotating the actuator through 360°.

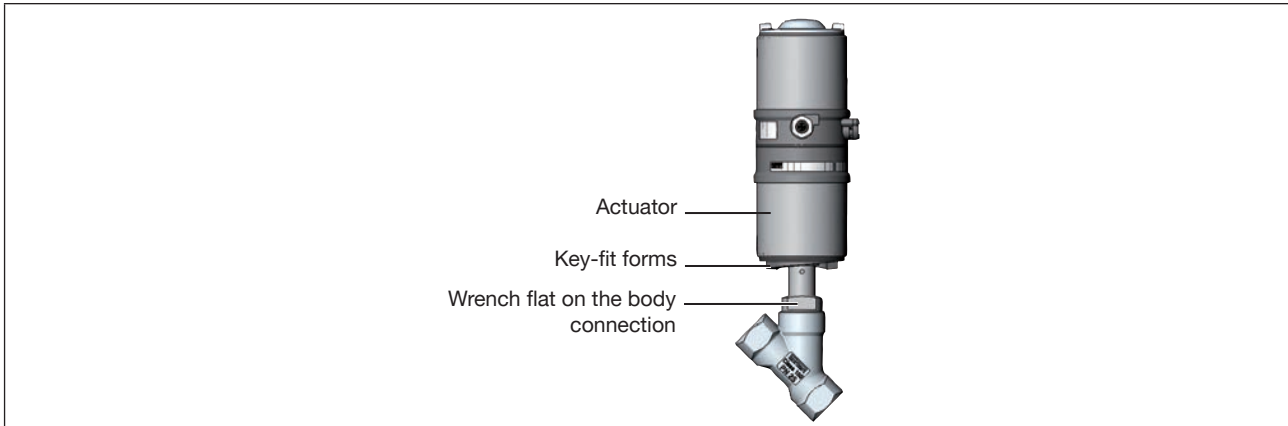

Figure 19: Turning the actuator (1), devices without hexnut

→ Clamp the valve body into a holding device (only for valves not yet installed).

NOTE

Damage to the seat seal or the seat contour.

▶ When turning the actuator, the valve must be open.

→ For control function A and I*:

Apply compressed air to pilot air port 1.

→ Switching the device manually with pilot valve (see chapter).

→ Using a suitable open-end wrench, counter the wrench flat on the body connection.

→ Use a special wrench** precisely in the key-fit forms of the actuator.

DANGER

Risk of injury from high pressure and discharge of medium.

If the direction of rotation is wrong, the body connection may become detached.

▶ Only turn the actuator in the prescribed direction.

→ By rotating in a clockwise direction (viewed from below), move the actuator to the desired position.

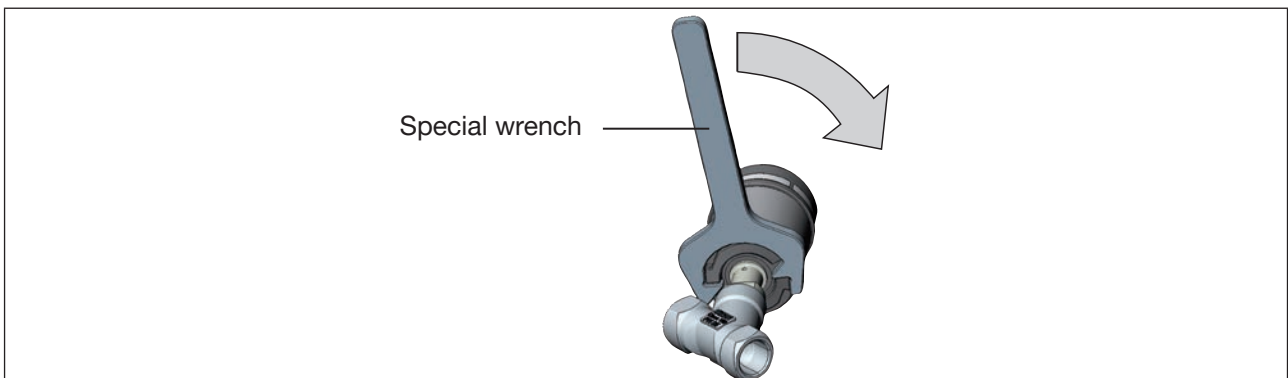

Figure 20: Turning the actuator (2), devices without hexnut

* if variant exists

** The special wrench (665702) can be procured from your Bürkert sales department.

7.4.3 Turning the device

! Only for devices with external pilot air duct (20xx, Classic).

The position of the connections can be aligned by rotating the device continuously through 360°.

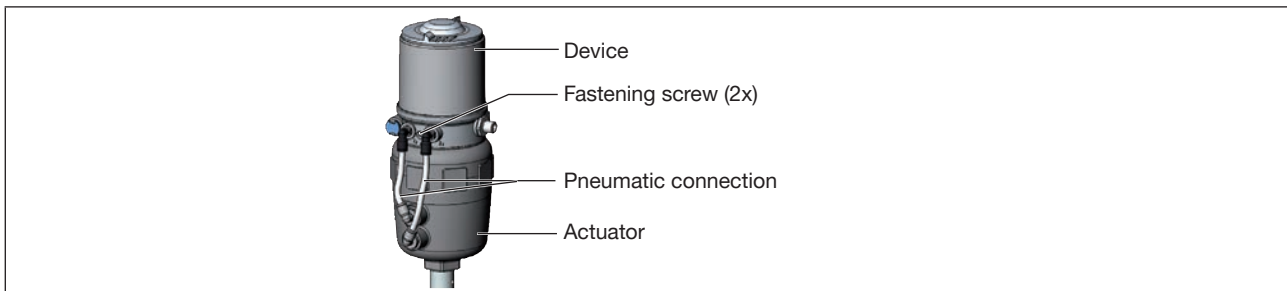

Figure 21: Turning the device

- Loosen pneumatic connection between device and actuator.
- Release fastening screws (hex socket bolt SW2.5).
- Rotate the device into the required position.

NOTE

Damage or malfunction due to ingress of dirt or moisture.

To observe the degree of protection IP65 or IP67:

- ▶ Tighten fastening screws only with a tightening torque of max. 1.5 Nm.
- ▶ Screw in body casing to the stop.
- ▶ Screw in transparent cap to the stop.
- ▶ Only for CFA and CFB: Connect the pilot air outlet which is not required to the free pilot air port of the actuator or seal with a plug.

- Only tighten the fastening screws until they are hand-tight (max. torque: 1.5 Nm).
- Re-establish pneumatic connections between device and actuator. If necessary, use longer hoses.

8 PNEUMATIC INSTALLATION

8.1 Safety instructions

DANGER

Risk of injury from high pressure and discharge of medium.

- ▶ Before working on the device or system, switch off the pressure. Vent or drain lines.

WARNING

Risk of injury from improper installation.

- ▶ Only trained technicians may perform installations.
- ▶ Perform installations with suitable tools only.

WARNING

Risk of injury due to unintentional activation and uncontrolled start-up of the system.

- ▶ Secure system against unintentional activation.
- ▶ Ensure that the system does not start up in an uncontrolled manner.

8.2 Connecting the device pneumatically

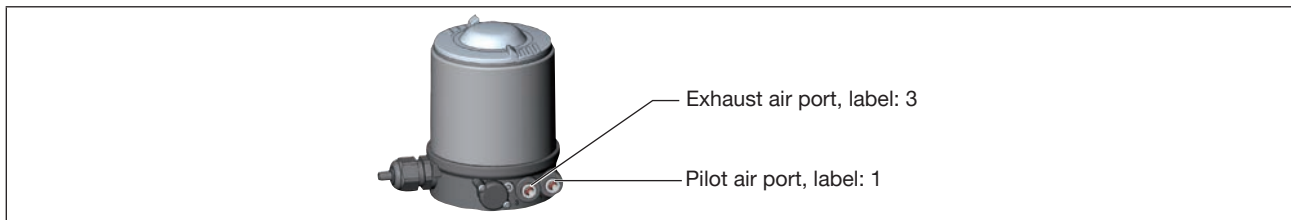

Figure 22: Connecting the device pneumatically

Important information for the problem-free functioning of the device:

- ▶ The installation must not cause back pressure to build up.
- ▶ Select a hose with sufficient cross section for the connection.
- ▶ Design the exhaust air line in such a way that no water or other liquid can get into the device through the exhaust air port.
- ▶ The pressure supply must always be at least 0.5–1 bar above the pressure required to bring the actuator into its end position.

→ Connect the control medium to the pilot air port (1)
(3–7 bar, instrument air, oil-free, anhydrous and dust-free).

→ Connect the exhaust air line or a silencer to the exhaust air port (3).

Exhaust air system:

- ▶ To maintain the IP67 degree of protection, install an exhaust air line in the dry area.

9 ELECTRICAL INSTALLATION

9.1 Safety instructions for electrical installation

DANGER

Risk of injury from electric shock.

- ▶ Before working on the device or system, switch off the power supply. Secure against reactivation.
- ▶ Observe applicable accident prevention and safety regulations for electrical equipment.

WARNING

Risk of injury from improper installation.

- ▶ Only trained technicians may perform installations.
- ▶ Perform installations with suitable tools only.

WARNING

Risk of injury due to unintentional activation and uncontrolled start-up of the system.

- ▶ Secure system against unintentional activation.
- ▶ Ensure that the system does not start up in an uncontrolled manner.

Minimum temperature rating of the cable to be connected to the field wiring terminals: 75 °C

9.2 Connecting the device electrically, IO-Link

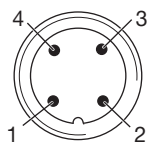

Figure 23: Pin assignment

Pin	Designation	Assignment	
		IO-Link mode	SIO mode
1	L +	24 V DC	
2	I/Q	Not assigned	DI or DO
3	L –	0 V (GND)	
4	Q/C	IO-Link	DI or DO

Table 4: Pin assignment

9.3 Connecting the device electrically, bÜS

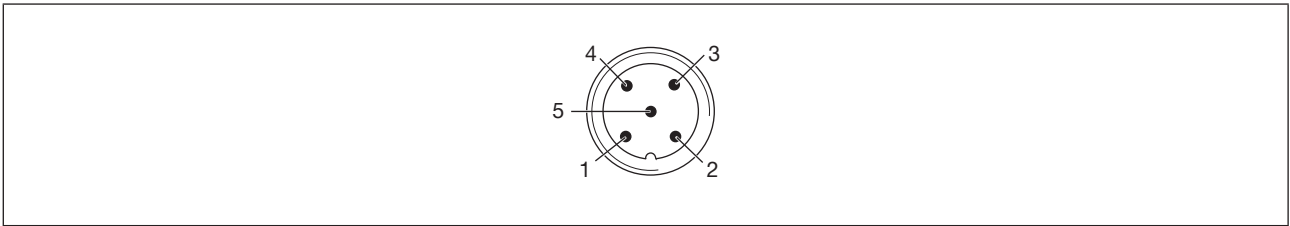

Figure 24: Pin assignment

Pin	Wire color	Assignment
1	CAN plate/shielding	CAN plate/shielding
2	red	+24 V DC \pm 10%, max. residual ripple 10%
3	black	GND / CAN_GND
4	white	CAN_H
5	blue	CAN_L

Table 5: Pin assignment



For electrical installation with bÜS network, note:
Use a 5-pin round plug and shielded 5-core cable.

10 START-UP

10.1 Teach function: Determine end positions and save these, REV.2

- **Automatic teach function:** For devices with pilot valve
The teach function automatically identifies and saves the end positions of the valve.
- **Manual teach function:** For devices without pilot valve
The end positions are captured and saved automatically.

10.1.1 Automatic teach function

For devices with pilot valve:

The teach function automatically identifies and saves the end positions of the valve.



With the IO-Link variant, the teach function can also be started with an acyclic IO-Link parameter (see parameter list) or with the Bürkert Communicator.



With the büS variant, the teach function can also be started with the Bürkert Communicator.

Essential requirements:

- The device is mounted on the actuator.
- The supply voltage is connected.
- The compressed air supply is connected.
- So that the correct reference conditions are identified, the pilot pressure must correspond to the operating conditions.

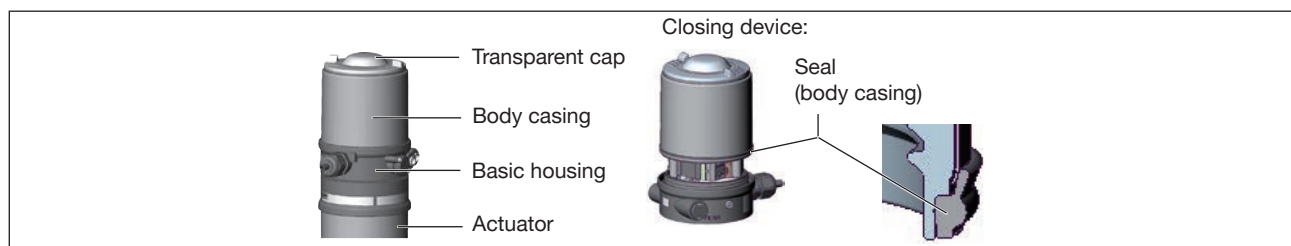

Figure 25: Opening or closing the device

NOTE

Breakage of the pneumatic connection pieces due to rotational impact.

- ▶ When opening or closing the device, do not press against the actuator, but against the basic housing.

→ Screw off the body casing by turning counterclockwise.

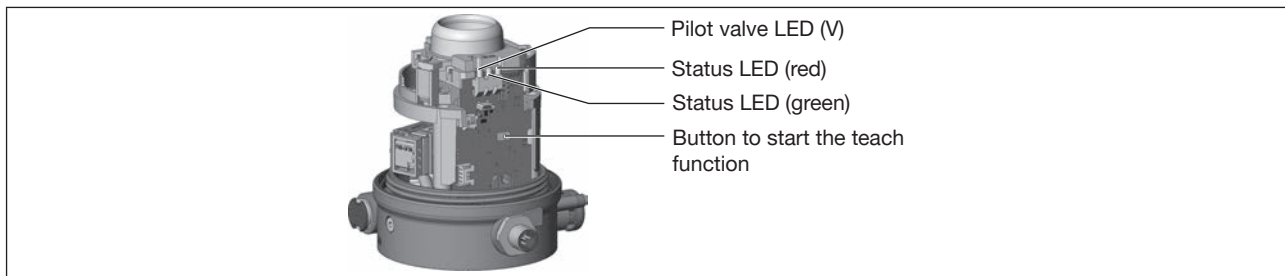

Figure 26: Starting teach function

→ Hold down the button to start the teach function for approx. 5 s until the red status LED blinks.

→ When the red status LED starts blinking, release the button within 5 seconds.

✔ When the red status LED stops blinking, the teach function is terminated.

✔ The end positions of the valve have been identified and saved.

→ Check that the seal (body casing) is in the correct position.

NOTE

Damage or malfunction due to ingress of dirt or moisture.

To observe the degree of protection IP65 or IP67:

▶ Screw in body casing to the stop.

→ Close the device (wrench*: 674077).

Description of workflow for teach function:

The status LED blinks red when the teach function is running.

- The end position is scanned in.
- The pilot valve switches.
- The actuator moves automatically to the upper position.
- The upper end position is scanned in.
- The pilot valve is switched off.
- The actuator moves to the lower position.
- In order to determine the opening time and the closing time, the actuator moves again into the upper and lower end position.

* The wrench (674077) is available from your Bürkert sales office..

10.1.2 Manual teach function

For devices without pilot valve:

The end positions are captured and saved manually by the user.



With the IO-Link variant, the teach function can also be started with an acyclic IO-Link parameter (see parameter list) or with the Bürkert Communicator.



With the büS variant, the teach function can also be started with the Bürkert Communicator.

Essential requirements:

- The device is mounted on the actuator.
- The supply voltage is connected.
- The compressed air supply is connected.
- So that the correct reference conditions are identified, the pilot pressure must correspond to the operating conditions.
- Provide the possibility for the user to switch the pneumatic actuator (open and closed).

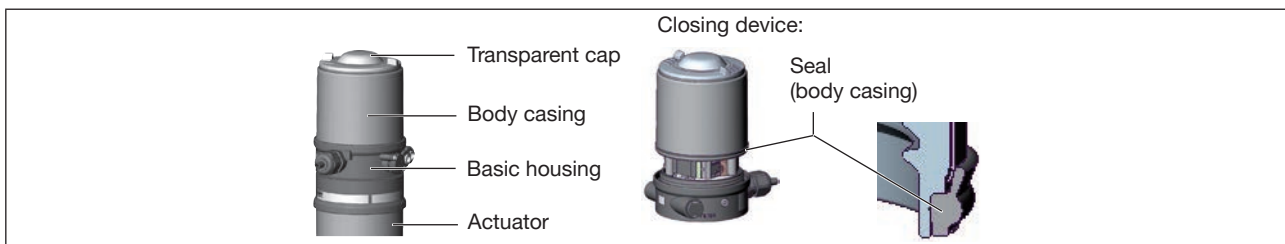

Figure 27: Opening or closing the device

NOTE

Breakage of the pneumatic connection pieces due to rotational impact.

- ▶ When opening or closing the device, do not press against the actuator, but against the basic housing.

→ Screw off the body casing by turning counterclockwise.

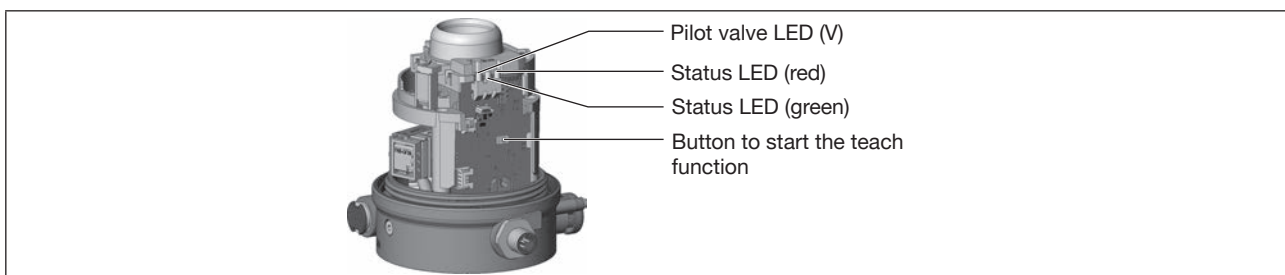

Figure 28: Starting teach function

→ Air bleed the pneumatic actuator: move to the unactuated end position.

→ Hold down the button to start the teach function for at least 10 s.
After 5 s, the red status LED will start blinking. Keep the button pressed down. After a further 5 s, the red LED blinks very quickly. Only then release the button.

✔ Status LED red blinks once every second: The manual teach function is active.

→ Check whether the pneumatic actuator is in the deaerated, unactuated end position.

→ This end position is confirmed by briefly pressing the button.

✔ Yellow pilot valve LED is lit.

→ Move the pneumatic actuator into the aerated, switched end position.

→ This end position is confirmed by briefly pressing the button.

✔ Yellow pilot valve LED is not lit.

→ Air bleed the pneumatic actuator: move to the unactuated end position.

✔ Yellow pilot valve LED is lit.

To determine the opening times and closing times, aerate and deaerate the pneumatic actuator:

Measurement of opening time (Opening_Time):

→ Move the pneumatic actuator into the aerated, switched end position.

✔ Yellow status LED is not lit.

Measurement of closing time (Closing_Time):

→ Air bleed the pneumatic actuator: move to the unactuated end position.

✔ When the red status LED stops lighting, the teach function is terminated.

✔ The end positions of the valve have been identified and saved.

Note: If the red LED is lit, the manual teach function is defective and must be repeated.

→ Check that the seal (body casing) is in the correct position.

NOTE

Damage or malfunction due to ingress of dirt or moisture.

To observe the degree of protection IP65 or IP67:

- ▶ Screw in body casing to the stop.

→ Close the device (wrench*: 674077).

* The wrench (674077) is available from your Bürkert sales office.

10.2 Setting with Bürkert Communicator

The Bürkert Communicator can be used to make all settings on the device.



The settings in the Bürkert Communicator can be found in the operating manual.

10.2.1 Connecting IO-Link device with Bürkert Communicator

Required components:

- Communications software: Bürkert Communicator for PC
- büS standard set (see accessories)
- büS adapter for büS service interface (see accessories)
- If necessary, a büS cable extension (see accessories)

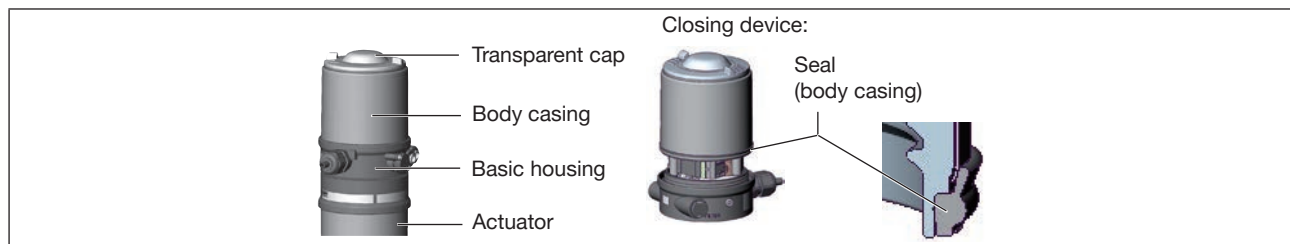

Figure 29: Opening or closing the device

NOTE

Breakage of the pneumatic connection pieces due to rotational impact.

- ▶ When opening or closing the device, do not press against the actuator, but against the basic housing.

→ Screw off the body casing by turning counterclockwise.

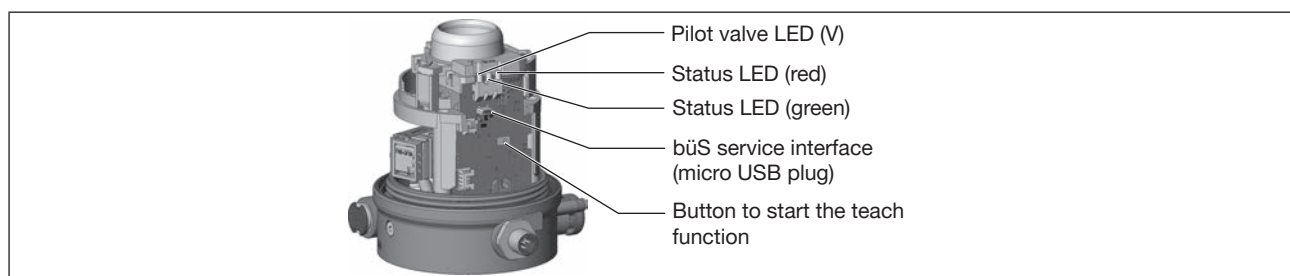

Figure 30: büS service interface

→ Insert micro USB plug in büS service interface.

→ Establish connection to PC with büS stick.

→ Starting Bürkert Communicator.

→ Implementing settings.

10.2.2 Connecting büS device with Bürkert Communicator

Required components:

- Communications software: Bürkert Communicator for PC
- büS standard set (see accessories)

→ Establish connection to PC with büS stick.

→ Starting Bürkert Communicator.

→ Implementing settings.

10.3 IO-Link

10.3.1 Information, IO-Link

IO-Link is an internationally standardized IO technology (IEC 61131-9) to enable sensors and actuators to communicate.

IO-Link is a point-to-point communication with 3-wire connection technology for sensors and actuators and unshielded standard sensor cables.

10.3.2 Technical specifications, IO-Link

IO-Link specifications	V1.1.2
Supply	via IO-Link (M12 x 1, 4-pin, A-coded)
Port Class	A
SIO mode	yes, optionally 2xDO (end positions), or 1xDI+1xDO (switch valve + one end position)
IODD file	Download from: www.burkert.com / Type 8691 / Software
VendorID	0x78, 120
DeviceID	see IODD file
Transmission speed	COM3 (230.4 kbit/s)
M-sequence type in Operate Mode	TYPE_2_V
Min. cycle time	1 ms
Data storage	Yes
Max. cable length	20 m

10.3.3 Interfaces, IO-Link

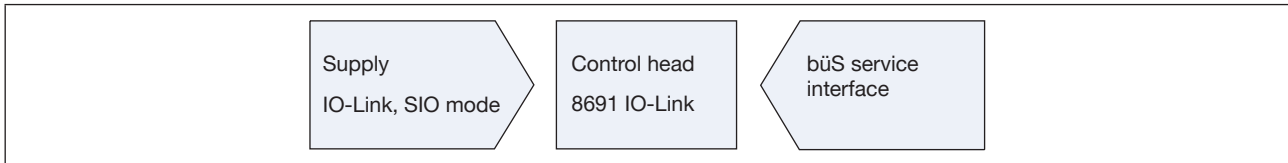

Figure 31: Interfaces

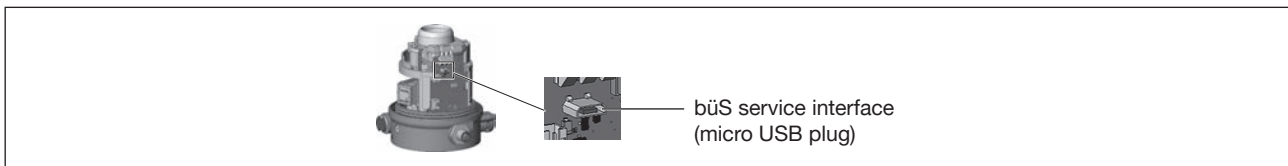

Figure 32: bÜS service interface

10.3.4 Configuration of the fieldbus

The required start-up files and the description of the process data and acyclic parameters are available on the Internet.



Download from:

www.burkert.com / Type 8691 / Software

10.4 büS

10.4.1 Information, büS

büS is a system bus developed by Bürkert with a communication protocol based on CANopen.

10.4.2 Interfaces, büS

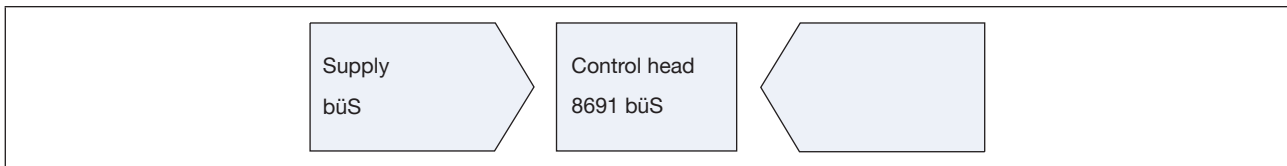

Figure 33: Interfaces

10.4.3 Configuration of the fieldbus

The required start-up files and the description of objects are available on the Internet.



Download from:

www.burkert.com / Type 8691 / Software

11 OPERATION

11.1 Display device status, IO-Link and bÜS

Following device statuses are indicated with LEDs:

- Pilot valve LED: Activation of pilot valve
- Device status LED: Valve position, errors, warnings
- Status LED green: IO-Link mode
- Status LED red: Teach function, error

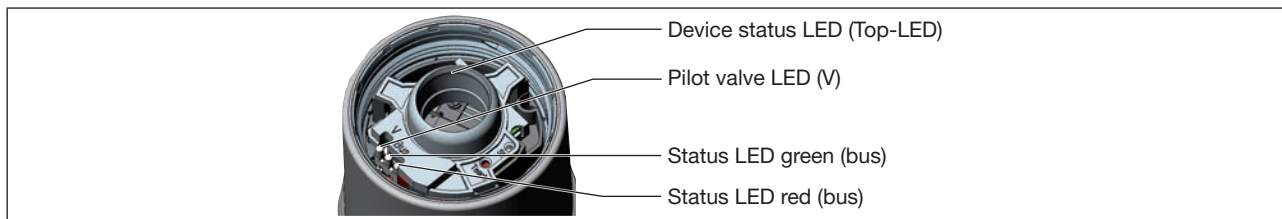

Figure 34: Display device status

Note the following when opening and closing the transparent cap:

NOTE

Breakage of the pneumatic connection pieces due to rotational impact.

- ▶ When opening or closing the device, do not press against the actuator, but against the basic housing.

NOTE

Damage or malfunction due to ingress of dirt or moisture.

To observe the degree of protection IP65 or IP67:

- ▶ Screw in transparent cap to the stop.

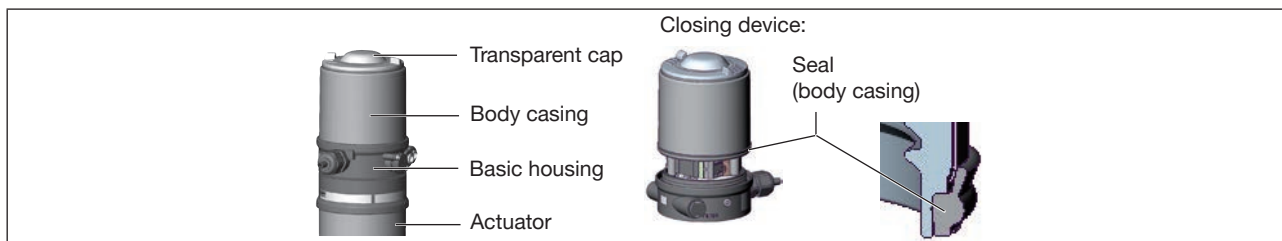

Figure 35: Opening or closing the device

11.1.1 Pilot valve LED

Color	Status	Description
yellow	is lit	Pilot valve is activated
yellow	is not lit	Pilot valve is not activated

Table 6: Pilot valve LED

11.1.2 Status LED, green and red

Color	Status	Description
green	is lit	
green	is not lit	IO-Link communication inactive
green	blinking	IO-Link communication active

Table 7: IO-Link status LED, green

Color	Status	Description
red	is lit	Teach function error
red	is not lit	After restart or successful teach function
red	blinking	Teach function active

Table 8: IO-Link status LED, red

11.1.3 Device status display

The device status LEDs (top LED) show the device status.

The user can set the following LED modes for the display of device status and valve position.

- Valve mode
- Valve mode with error messages
- Valve mode with error messages and warnings (factory setting)
- NAMUR mode
- LED off

IO-Link:

The LED mode and the colors of the valve position can be set with an acyclic IO-Link parameter (see parameter list) or with the Bürkert Communicator.

büS:

The LED mode and the colors of the valve position can be set with the Bürkert Communicator.



The description for setting the LED mode can be found in the section "Setting the LED mode" in the operating manual.

11.1.3.1 Valve mode

Displays in valve mode:

- Valve position: open, half-way, closed

Valve position	Valve position status, color
Open	is lit yellow*
Half-way	LED off*
Closed	is lit green*

Table 9: Valve mode

11.1.3.2 Valve mode + errors

Displays in valve mode + errors:

- Valve position: open, half-way, closed
- Device status: Error

Valve position	Valve position status, color	Device status: Error status, color
Open	is lit yellow*	blinks alternately with color of valve position
Half-way	LED off*	blinks alternately with color of valve position
Closed	is lit green*	blinks alternately with color of valve position

Table 10: Valve mode + errors

11.1.3.3 Valve mode + errors + warnings

Displays in valve mode + errors + warnings:

- Valve position: open, half-way, closed
- Device status: Error
- Device status: Displays of NAMUR mode

If several device statuses exist simultaneously, the device status with the highest priority is displayed.

Valve position	Valve position status, color	Device status: Error status, color
Open	is lit yellow*	blinks alternately red and yellow*
Half-way	LED off*	blinks alternately red and white*
Closed	is lit green*	blinks alternately red and green*

Table 11: Valve mode + errors + warnings, part 1

* Factory setting, selectable colors for the valve position: Off, white, green, blue, yellow, orange, red

Valve position	Valve position status, color	Device status: Function control status, color
Open	is lit yellow*	blinks alternately orange and yellow*
Half-way	LED off*	blinks alternately orange and white*
Closed	is lit green*	blinks alternately orange and green*

Table 12: Valve mode + errors + warnings, part 2

Valve position	Valve position status, color	Device status: Out of specification status, color
Open	is lit yellow*	blinks alternately yellow and yellow*
Half-way	LED off*	blinks alternately yellow and white*
Closed	is lit green*	blinks alternately yellow and green*

Table 13: Valve mode + errors + warnings, part 3

Valve position	Valve position status, color	Device status: Maintenance required status, color
Open	is lit yellow*	blinks alternately blue and yellow*
Half-way	LED off*	blinks alternately blue and white*
Closed	is lit green*	blinks alternately blue and green*

Table 14: Valve mode + errors + warnings, part 4

For error messages and warning messages, the LEDs are briefly switched off between the change of the colors.

For localizations, the colors are only shown momentarily.

* Factory setting, selectable colors for the valve position: Off, white, green, blue, yellow, orange, red

11.1.3.4 NAMUR mode

The device status LEDs (top LED) show the device status.

The display elements change color in accordance with NAMUR NE 107.

If several device statuses exist simultaneously, the device status with the highest priority is displayed. The priority is determined by the severity of the deviation from controlled operation (red LED = failure = highest priority).

Status display in accordance with NE 107, edition 2006-06-12			
Color	Color code	Status	Description
Red	5	Outage, error or malfunction	Normal operation is not possible due to a malfunction in the device or on its peripheral equipment.
Orange	4	Function check	Work is being carried out on the device; normal operation is therefore temporarily not possible
Yellow	3	Out of specification	Ambient conditions or process conditions for the device are outside the specified area.
Blue	2	Maintenance required	The device is in normal operation, although a function is briefly restricted. → Service device.
Green	1	Diagnostics active	Device is operating perfectly. Status changes are indicated in different colors. Messages are transmitted via a fieldbus if connected.

Table 15: Description of the colors

11.2 Switching the device manually with pilot valve

The device can be switched manually with the pilot valve when the control air is connected.

Opening the device:

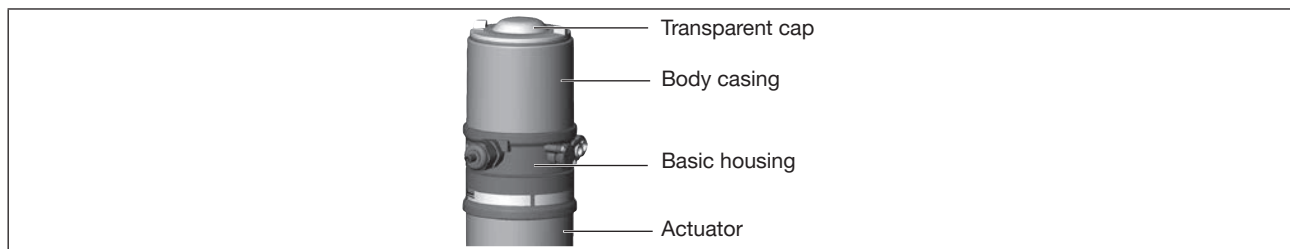

Figure 36: Opening the device

NOTE

Breakage of the pneumatic connection pieces due to rotational impact.

► When opening or closing the device, do not press against the actuator, but against the basic housing.

→ Screw off the body casing by turning counterclockwise.

Switching the device:

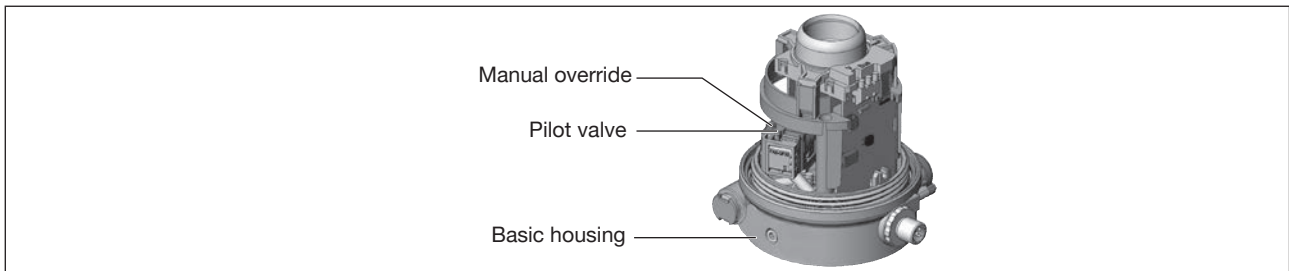

Figure 37: Manually switching the device

NOTE

Damage to the manual override by pressing and rotating at the same time.

- ▶ Do not simultaneously press and turn manual override.

Switching the positions for manual override:

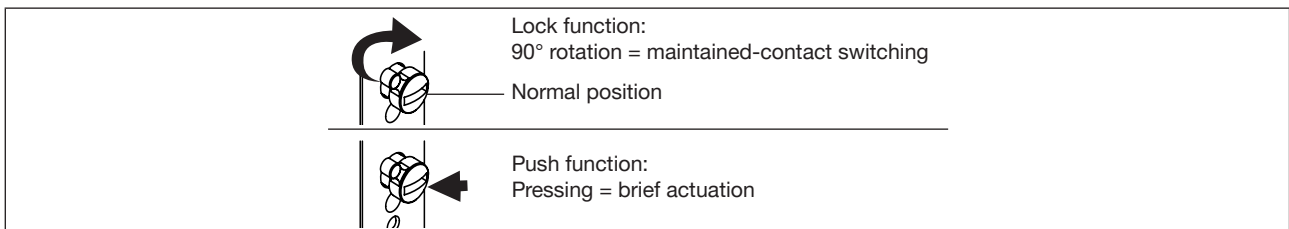

Figure 38: Manual override

→ Switch manual override with a screwdriver (button or click).

Closing the device:

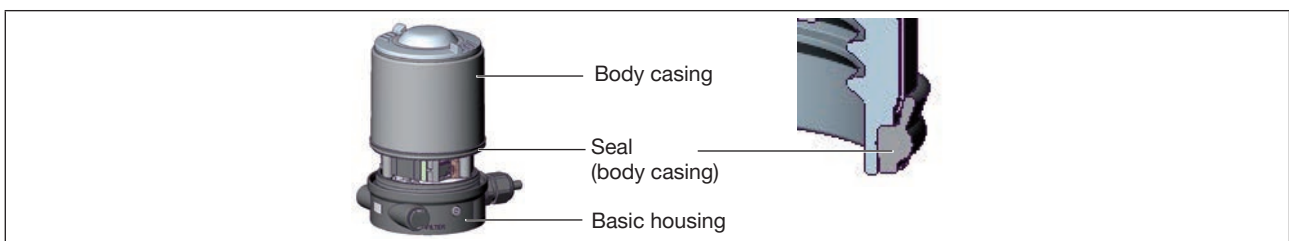

Figure 39: Closing the device

→ Check that seal is in the correct position.

NOTE

Damage or malfunction due to ingress of dirt or moisture.

To observe the degree of protection IP65 or IP67:

- ▶ Screw in body casing to the stop.

→ Close the device (wrench*: 674077).

* The wrench (674077) is available from your Bürkert sales office..

12 MAINTENANCE

12.1 Servicing the air intake filter

To protect the pilot valve and actuator, the pilot air is filtered.

Air flows through the air intake filter from inside to outside through the filter fabric in its pre-installed state.

DANGER!

Risk of injury if not maintained correctly.

- ▶ Only trained and qualified personnel may perform maintenance.
- ▶ Perform maintenance with suitable tools only.

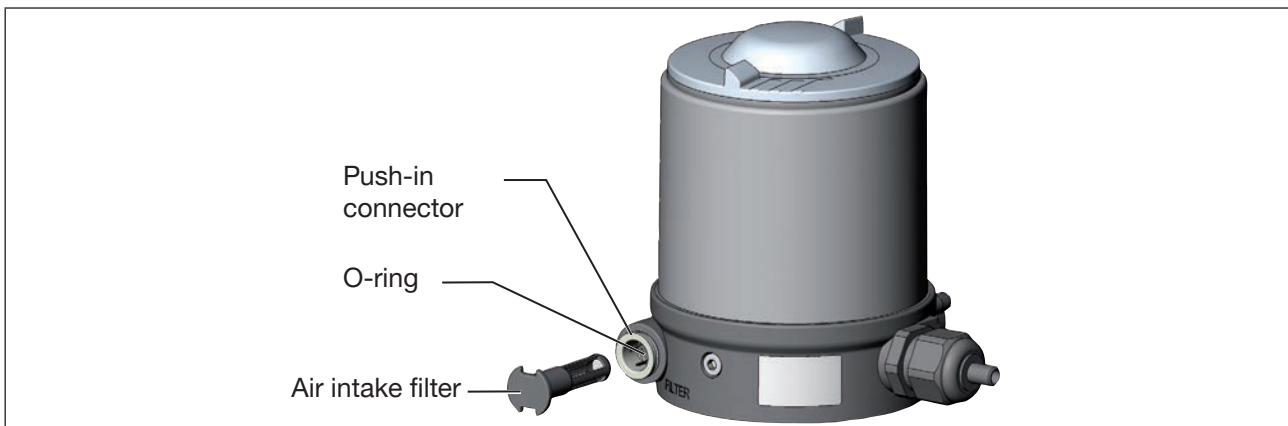

Figure 40: Servicing the air intake filter

DANGER!

Risk of injury from high pressure and discharge of medium.

- ▶ Before working on the device or system, switch off the pressure. Vent or drain lines.

- Unclamp the push-in connector by pressing the collet, then pull out the air intake filter. If necessary, use a suitable tool between the recesses in the head of the air intake filter.
- Clear or (if appropriate) replace the filter.
- Check the inside O-ring and clean if necessary.
- Push the air intake filter into the push-in connector as far as it will go.
- Ensure that the air intake filter is securely seated.

13 DEINSTALLATION

13.1 Safety instructions deinstallation

 **DANGER**

Risk of injury from high pressure and discharge of medium.

- ▶ Before working on the device or system, switch off the pressure. Vent or drain lines.

 **DANGER**

Risk of injury from electric shock.

- ▶ Before working on the device or system, switch off the power supply. Secure against reactivation.
- ▶ Observe applicable accident prevention and safety regulations for electrical equipment.

 **WARNING**

Risk of injury due to improper deinstallation.

- ▶ Only trained technicians may perform deinstallations.
- ▶ Perform deinstallations with suitable tools only.

 **WARNING**

Risk of injury due to unintentional activation and uncontrolled start-up of the system.

- ▶ Secure system against unintentional activation.
- ▶ Ensure that the system does not start up in an uncontrolled manner.

13.2 Deinstallation

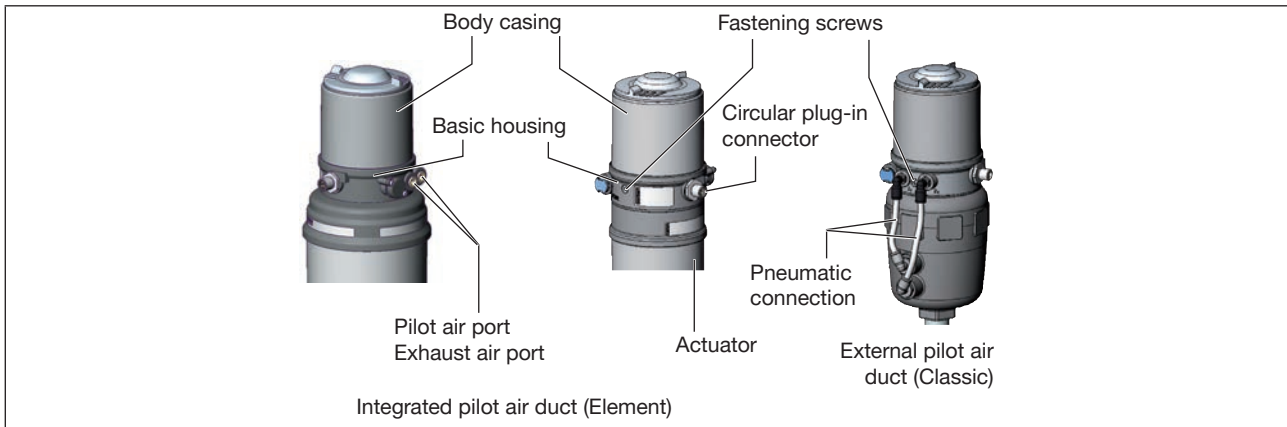

Figure 41: Deinstalling the device

Pneumatically deinstalling the device

- Disconnect pilot air port.
- When exhaust air port connected: Disconnect exhaust air port:
- With external control air duct (Classic):
Disconnect the pneumatic connection to the actuator.

Electrically deinstalling the device

Devices with circular plug-in connector:

- Disconnect the circular plug.

Mechanically deinstalling the device

- Release the fastening screws.
- Pull off the device by lifting upward.

14 SPARE PARTS, ACCESSORIES

Designation	Order no.
Special wrench	665702
Wrench for opening/closing the transparent cap	674077
Communication software Bürkert Communicator	Information at www.burkert.com

USB-büS interface set:	
büS standard set (büS stick + 0.7 m cable with M12 plug)	772551
büS adapter for büS service interface (M12 on büS service interface Micro-USB)	773254
büS cable extension (M12 pin to M12 socket), length 1 m	772404
büS cable extension (M12 pin to M12 socket), length 3 m	772405
büS cable extension (M12 pin to M12 socket), length 5 m	772406
büS cable extension (M12 pin to M12 socket), length 10 m	772407

Table 16: Accessories

14.1 Communications software

The Bürkert Communicator PC program is designed for communication with Type 8691 devices with fieldbus control via DeviceNet, IO-Link or büS. Devices from year of construction April 2014 support the full range of functions.

For questions regarding compatibility, please contact the Bürkert Sales Center.



A detailed description for installing and operating the software can be found in the associated operating instructions.

Download the software from: www.burkert.com

15 TRANSPORTATION, STORAGE, DISPOSAL

NOTE

Damage in transit due to inadequately protected devices.

- ▶ Protect the device against moisture and dirt in shock-resistant packaging during transportation.
- ▶ Observe permitted storage temperature.

NOTE

Incorrect storage may damage the device.

- ▶ Store the device in a dry and dust-free location.
- ▶ Storage temperature: -20 to +65 °C

NOTE

Damage to the environment caused by device components contaminated with media.

- ▶ Dispose of the device and packaging in an environmentally friendly manner.
- ▶ Observe applicable disposal and environmental regulations.



Observe national regulations on the disposal of waste.

