

CATALOG
air prep

280 Series

Digital Pressure / Vacuum Sensors



NUMATICS®

Numatics, Inc. is a leading manufacturer of pneumatic products and motion control products. Our broad spectrum of standard, custom developed products and application components, have made a significant impact on pneumatic innovation as well as pneumatic and motion control technology. Our company has an extensive history of generating innovative concepts and technological breakthroughs. Many of today's standard features in pneumatic technology were industry firsts from Numatics. We continue our innovative approach to product development by developing electric motion control solutions and enhancing our embedded Fieldbus and I/O products to continually meet and solve our customer's application requirements.

Today Numatics is proud to be a part of the Industrial Automation Division of Emerson Electric Co.

Emerson (NYSE: EMR) is a global company that brings together technology and engineering to provide innovative solutions for customers in a wide range of industrial, commercial, and consumer markets.

Numatics, along with the vast resources of the Emerson organization, will assure that our proud history of innovation and service will continue to meet the needs of our global customers.



EMERSON™
Industrial Automation

Table of Contents



280 Series <i>DPS / DVS</i>	2-4
Features & Benefits	2
How to Order	3
Accessory Numbers	3
Panel Instructions	3
Output Circuit Wiring	3
Dimensions	4
Panel & Mounting Bracket Kits	4
Digital Sensor Fittings	5



280 Series Digital Pressure / Vacuum Sensor



Application

Numatics DPS / DVS 280 series digital sensors can be used as a digital pressure / vacuum gauge for accurate visual display of the current value. It can also be used as a controls device designed for applications requiring extremely accurate measurement of a specific value, then generating a digital input to the PLC or controls system. The large LCD display is easy to view. It changes color indicating the set point is achieved, causing the digital output to change state. Other features include quick response (2.5 ms or less), repeatable to $\pm 0.2\%$ of full scale ± 1 digit, raised set buttons for simple intuitive programming of the hysteresis or window comparator modes of operation.

Applications include verification of part present, quality assurance using decay leak testing, control of edges on film winding, clamping forces, evacuate and fill circuits, pump up and down circuits and many more.



DPS280



DVS280

Features

- Hysteresis and Window comparator modes of operation
- Large 7 segment LCD display
- Selectable Two Color Display (Red / Green or Green / Red)
Large display changes color at set point achieved
- Selectable Single Color Only Display (Red or Green)
"OUT" Displayed when digital output is "ON"
- Panel display shows - Selected units, operation mode, output type (n.o. / n.c.), setting mode and key lock
- Ease of wiring 8 mm 4 Pin Pico Connector (2M Mating cable included)
- CE Marked - RoHs Compliant

SPECIFICATIONS		DPS280 (PRESSURE)	DVS280 (VACUUM)
Rated pressure range		0 ~ 1000 kPa 0 ~ 145 PSIG	0.0 ~ - 101.3 kPa 0 ~ 29.9" Hg Vacuum
Operating / Set pressure range		-100 ~ 1000 kPa - 14.5 PSIG ~ + 145 PSIG	10.0 ~ - 101.3 kPa 1.45 PSIG ~ 29.9" Hg Vacuum
Maximum pressure		1500 kPa	300 kPa
(Exceeding max pressure could damage switch)		217.5 PSIG	43.5 PSIG
Fluid		Air, Non-corrosive gases, incombustible gases	
Set pressure resolution	kPa	1	0.1
	kgf/cm ²	0.01	0.001
	bar	0.01	0.001
	psi	0.1	0.01
	InHg	-	0.1
	mmHg	-	1
Power supply voltage		12 to 24VDC $\pm 10\%$, Ripple (P-P) 10 % or less	
Current consumption		$\leq 45\text{mA}$ (with no load)	
Switch output		PNP open collector Max. load current: 125mA Max. supply voltage: 24VDC Residual voltage: $\leq 1.5\text{V}$ (load current 125mA)	NPN open collector Max. load current: 125mA Max. supply voltage: 30VDC Residual voltage: $\leq 1.5\text{V}$ (load current 125mA)
	Repeatability (Switch output)	$\leq \pm 0.2\%$ F.S. ± 1 digit	
Hysteresis mode	Adjustable		
Window comparator mode			
Response time	$\leq 2.5\text{ms}$ (chatter-proof function: 24ms, 250ms, 500ms, 1000ms and 1500ms selections)		
Output short circuit protection	Yes		
7 segment LCD display	Two color (red/green) display (sampling rate: 5 times/1sec.)		
Indicator accuracy	$\leq \pm 2.0\%$ F.S. ± 1 digit (ambient temp: 77°F $\pm 5^\circ\text{F}$ / 25°C $\pm 3^\circ\text{C}$)		
Switch ON Indicator	Green OUT Indicator		
Enclosure	IP40		
	Ambient temp. range	Operation: 0°F ~ 122°F / 0°C ~ 50°C, Storage: 14°F ~ 140°F / -10°C ~ 60°C (no condensation or freezing)	
Ambient humidity range	Operation/Storage: 35 ~ 85% RH (no condensation)		
Environment	Withstand voltage	1000VAC in 1-min (between case and lead wire)	
	Insulation resistance	50Mohm min. (at 500 VDC, between case and lead wire)	
Vibration	Total amplitude 1.5mm, 10Hz-55Hz-10Hz scan for 1 minute, two hours each direction of X,Y and Z		
	Shock	100m/s ² (10G), 3 times each in direction of X,Y and Z	
Temperature characteristic	$\leq \pm 2\%$ F.S. of detected pressure (77°F / 25°C) at temp. Range of 0°F ~ 122°F / 0°C ~ 50°C		
Port size	1/8" NPT Male x 10-32 UNF Female		
Lead wire	Oil-resistant cable (0.15 mm ²)		
Weight	Approx *45g - Switch only		
	Approx *90g - Switch with 2M mating cable		



How to Order

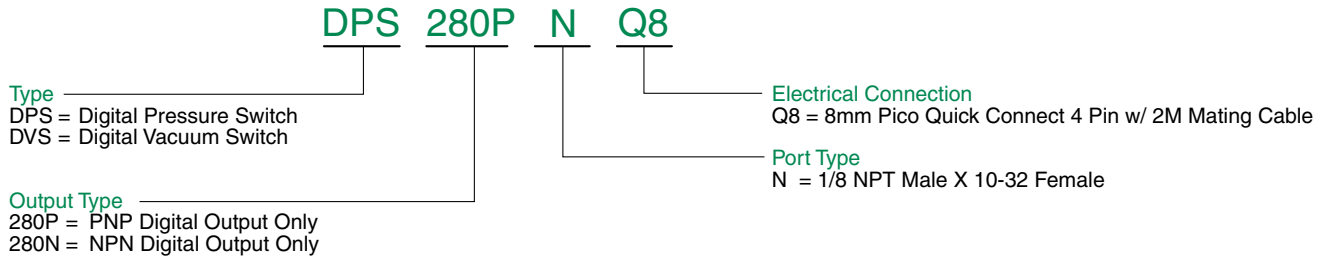

Example: DPS280PNQ8 = Digital Pressure Switch - PNP - 1/8 NPT - 8mm Pico 4 Pin w/ 2M Mating Cable

Accessory Numbers

Model	Accessory Description
DPS280-8-4-ST-2	Mating Cable 8 mm 4 Pin 2 Meter
DPS280-8-4-ST-5	Mating Cable 8 mm 4 Pin 5 Meter
PC0402MEETA03000	Patch Cable M8 4 Pin X M12 3 Pin 2 Meter

Model	Accessory Description
BRK280-1	Mounting Bracket (S)
BRK280-2	Mounting Bracket (L)
PMK280-C	Panel Mount Kit w/Cover

Mating Cable: Cable O.D. - 4.0mm
 Conductor Gauge - 26 AWG

Panel Instructions

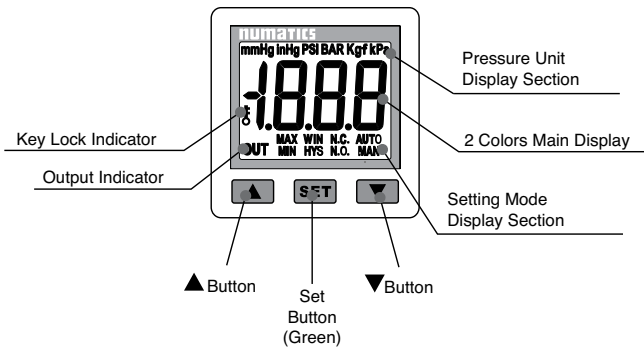

Switch Wiring

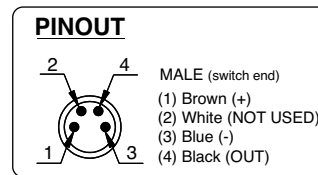

Output Circuit Wiring

DPS / DVS280P

PNP output

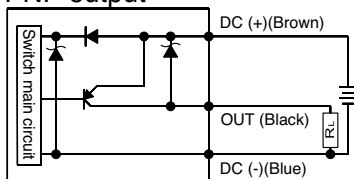

DPS / DVS280N

NPN output

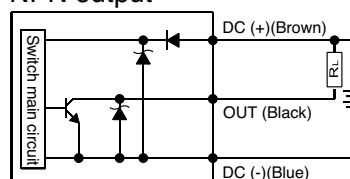



Dimensions

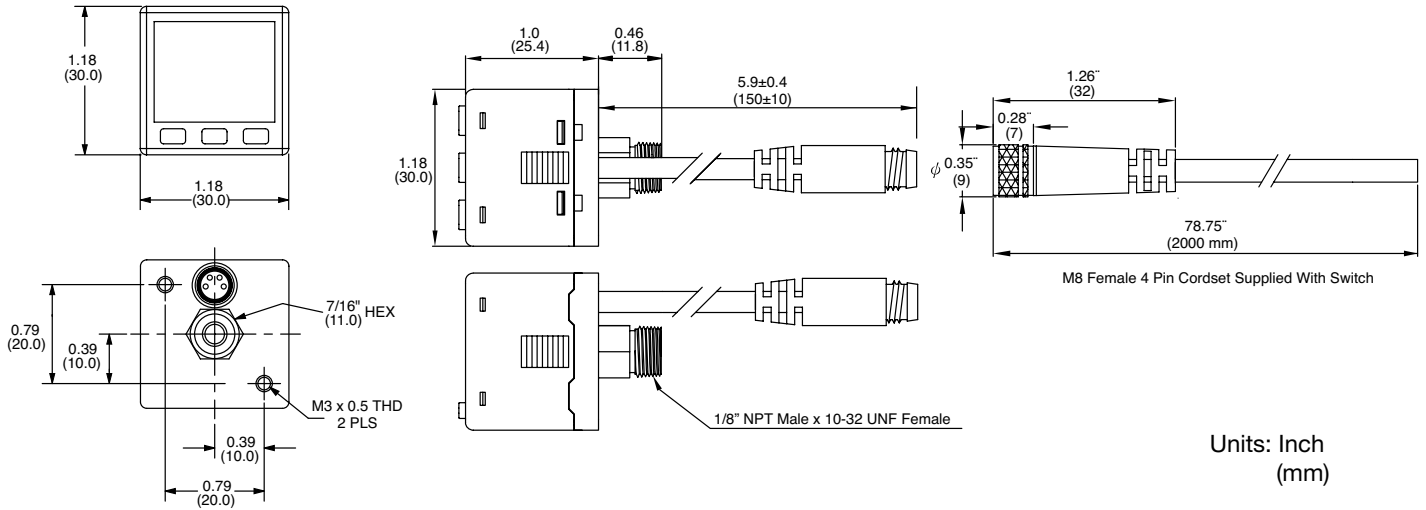

Units: Inch
(mm)

Mounting Bracket Kits (2 M3 Screws Included)

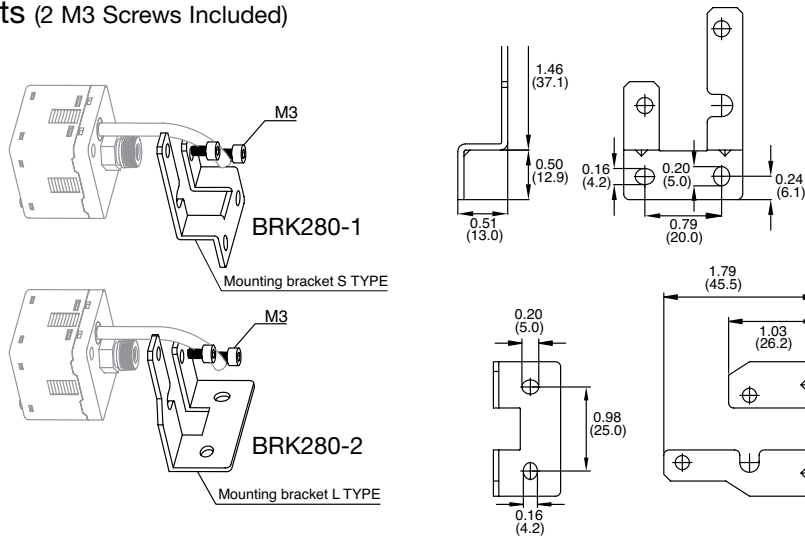

Units: Inch
(mm)

Panel Mounting Kit (Includes 2 adapters & 1 cover)

PMK280-C

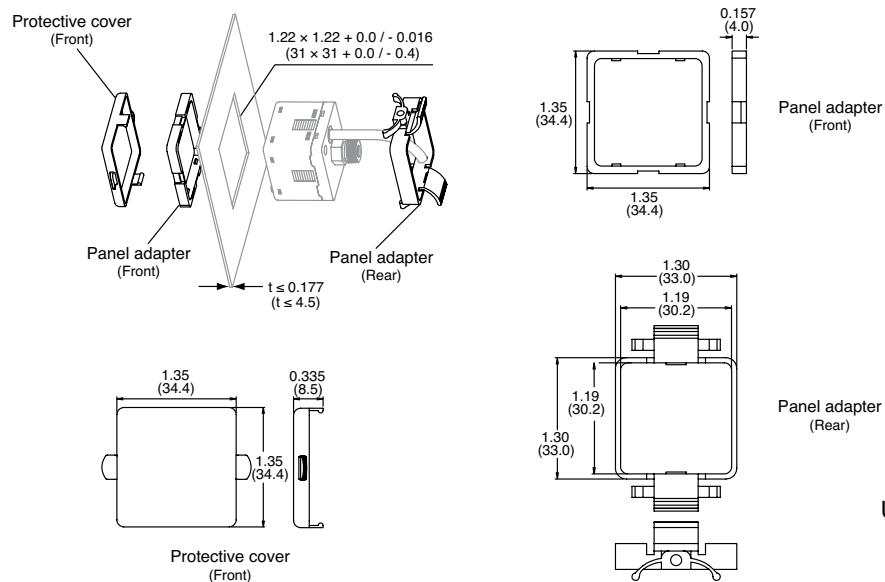

Units: Inch
(mm)



Inch Fittings (Nickel Plated Brass)

INB103 Male Connector

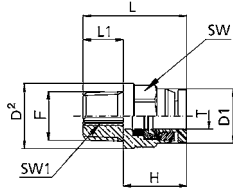

Model Number	Tube Diameter (T)	Thread (F)	D1	D2	L	L1	H	SW	SW1
INB103-108-036	1/8	10-32 UNF	0.370	0.370	0.697	0.165	0.472	/	5/64
INB103-532-036	5/32	10-32 UNF	0.394	0.394	0.717	0.165	0.492	/	5/64
INB103-104-036	1/4	10-32 UNF	0.472	0.472	0.772	0.165	0.531	/	5/64

INB105 Female Connector

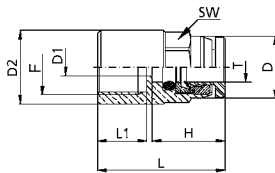

Model Number	Tube Diameter (T)	Thread (F)	D	D1	D2	L	L2	H	SW
INB105-108-020	1/8	1/8 NPTF	0.370	0.094	0.551	0.945	0.335	0.472	3/8
INB105-532-020	5/32	1/8 NPTF	0.394	0.118	0.551	0.965	0.335	0.492	7/16
INB105-104-020	1/4	1/8 NPTF	0.472	0.157	0.551	0.965	0.335	0.531	1/2
INB105-516-020	5/16	1/8 NPTF	0.591	0.236	0.669	1.055	0.335	0.630	19/32

INB109 Swivel Elbow

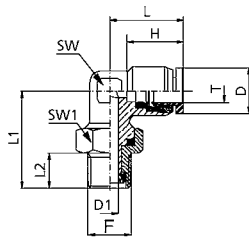

Model Number	Tube Diameter (T)	Thread (F)	D	D1	L	L1	L2	H	SW	SW1
INB109-108-036	1/8	10-32 UNF	0.394	0.087	0.638	0.630	0.165	0.472	0.354	0.354
INB109-532-036	5/32	10-32 UNF	0.394	0.087	0.657	0.630	0.165	0.492	0.354	0.354
INB109-104-036	1/4	10-32 UNF	0.472	0.087	0.740	0.709	0.165	0.531	0.433	0.354

Metric Fittings (Nickel Plated Brass)

NB104 Male Connector without External Hex

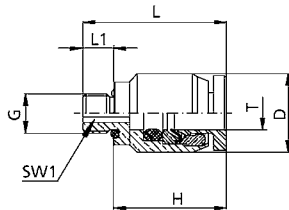

Model Number	Tube Diameter (T)	Thread (G)	D	H	L	L1	SW1
NB104-004-005	4.0	M5	10.0	14.4	18.4	4.0	2
NB104-005-005	5.0	M5	11.0	14.7	18.7	4.0	2
NB104-006-005	6.0	M5	12.0	15.3	19.3	4.0	2

NB108 Swivel Elbow

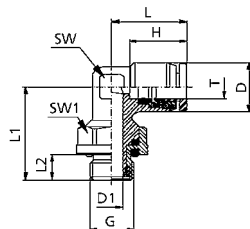

Model Number	Tube Diameter (T)	Thread (G)	D	D1	H	L	L1	L2	SW	SW1
NB108-004-005	4.0	M5	9.9	2.3	12.2	16.6	16.5	4.0	9	9
NB108-005-005	5.0	M5	10.9	2.3	12.7	16.6	18.0	4.0	10	9
NB108-006-005	6.0	M5	11.9	2.3	13.3	19.1	18.5	4.0	11	9

NUMATICS

*World Class Supplier
of Pneumatic Components*

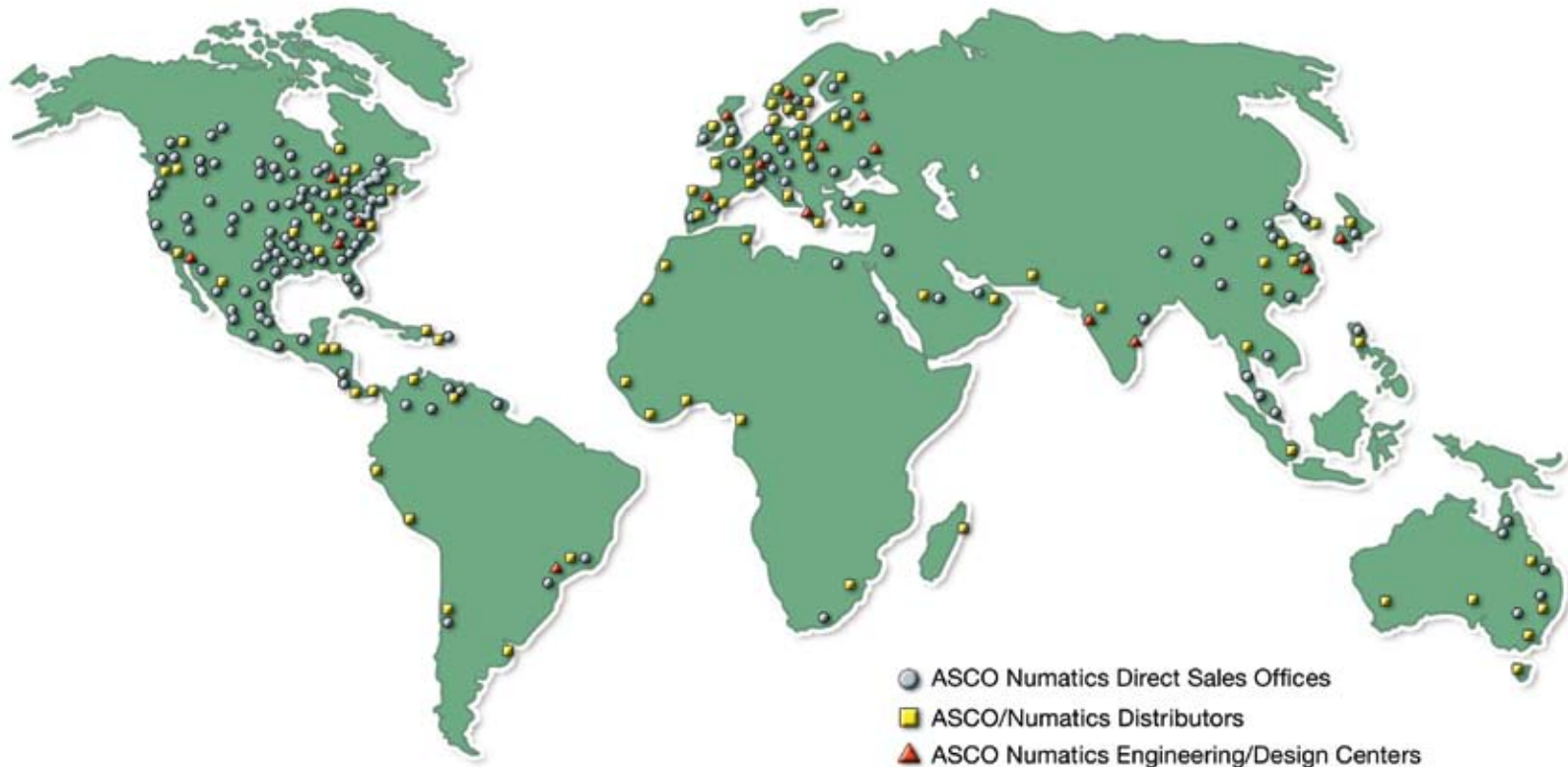

WORLD HEADQUARTERS

USA

Numatics, Incorporated

46280 Dylan Drive
Novi, Michigan 48377

P: 1-888-Numatics
1-888-686-2842

Canada

Numatics, Ltd

P: 519-452-1777

Mexico

Numatics de Mexico S.A. de C.V.

P: 52-222-284-6176

For a comprehensive listing of all Numatics production and distribution facilities worldwide, visit:

www.numatics.com