





Pneumatically operated 2/2-way Diaphragm Valve with plastic body

- Control function convertible
- Can be used for aggressive medium
- Compact design



Product variants described in the data sheet may differ from the product presentation and description.

Can be combined with

| | | |
|---|---|---|
|  | Type 6014 Plunger valve 3/2-way direct-acting | ▶ |
|  | Type 7012 Direct-acting 3/2-way plunger valve | ▶ |
|  | Type 8644 AirLINE SP electropneumatic automation system | ▶ |

Type description

2/2-way plastic diaphragm valve, pilot operated with pneumatic actuator and spring return. Used for polluted medium in process and water technology.

DTS 1000020595 EN Version: J Status: RL (released | freigegeben | valide) printed: 12.05.2026

Table of contents

| | |
|---|----------|
| 1. General technical data | 3 |
| 2. Control functions | 3 |
| 3. Approvals and conformities | 4 |
| 3.1. General notes | 4 |
| 3.2. Conformity | 4 |
| 3.3. Standards | 4 |
| 4. Materials | 4 |
| 4.1. Bürkert resistApp | 4 |
| 5. Dimensions | 5 |
| 5.1. DN 15, screwed connection with Ø 20 threaded socket | 5 |
| 5.2. DN 12, G 3/8 threaded socket, Ø 16 glued socket connection or weld socket connection | 5 |
| 6. Performance specifications | 6 |
| 6.1. Pressure temperature diagram | 6 |
| 6.2. Pilot pressure diagram | 6 |
| 7. Ordering information | 7 |
| 7.1. Bürkert eShop | 7 |
| 7.2. Bürkert product filter | 7 |
| 7.3. Ordering chart | 7 |
| 7.4. Ordering chart accessories | 8 |
| 3/2-way pilot valve Typ 7012 with plug pattern: Form B | 8 |
| Replacement diaphragms for all nominal diameters | 8 |
| Cable plug Type 2507 according to industry standard connector Form B | 8 |

DTS 1000020595 EN Version: J Status: RL (released | freigegeben | valide) printed: 12.05.2026

1. General technical data

| Product properties | |
|---|---|
| Dimensions | Further information can be found in chapter "5. Dimensions" on page 5. |
| Material | |
| Body | PVC-U, PP |
| Actuator | PP, glass-fibre reinforced |
| Seal | EPDM |
| Performance data | |
| Pilot pressure | Max. 7 bar, Further information can be found in chapter "6.1. Pressure temperature diagram" on page 6 |
| Medium data | |
| Operating medium | Neutral or aggressive mediums that do not attack the body and seal materials |
| Medium temperature | Further information can be found in chapter "6.1. Pressure temperature diagram" on page 6. |
| Control medium | Lubricated/non lubricated compressed air and other neutral medium (e.g. water) |
| Process/Port connection & communication | |
| Port connection | Further information can be found in chapter "7.3. Ordering chart" on page 7. |
| Environment and installation | |
| Installation position | See operating manual Type 3230 ▶ |
| Ambient temperature | 0 °C...+ 60 °C |

2. Control functions

| Control function | Description |
|------------------|---|
| | Control function A (CF A) Pneumatically operated 2/2-way on/off valve Flow direction above seat Normally closed by spring force |
| | Control function B (CF B) Single-acting actuator for pneumatically operated 2/2-way on/off valve Normally opened by spring force |

DTS 1000020595 EN Version: J Status: RL (released | freigegeben | valide) printed: 12.05.2026

3. Approvals and conformities

3.1. General notes

- The approvals and conformities listed below must be stated when making enquiries. This is the only way to ensure that the product complies with all required specifications.
- Not all available versions can be supplied with the below mentioned approvals or conformities.

3.2. Conformity

In accordance with the Declaration of Conformity, the product is compliant with the EU Directives.

3.3. Standards

The applied standards which are used to demonstrate compliance with the EU Directives are listed in the EU-Type Examination Certificate and/or the EU Declaration of Conformity.

4. Materials

4.1. Bürkert resistApp

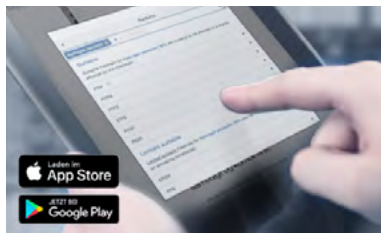

Bürkert resistApp – Chemical resistance chart

You want to ensure the reliability and durability of the materials in your individual application case? Verify your combination of media and materials on our website or in our resistApp.

[Start chemical resistance check](#)

5. Dimensions

5.1. DN 15, screwed connection with Ø 20 threaded socket

Note:

Dimensions in mm

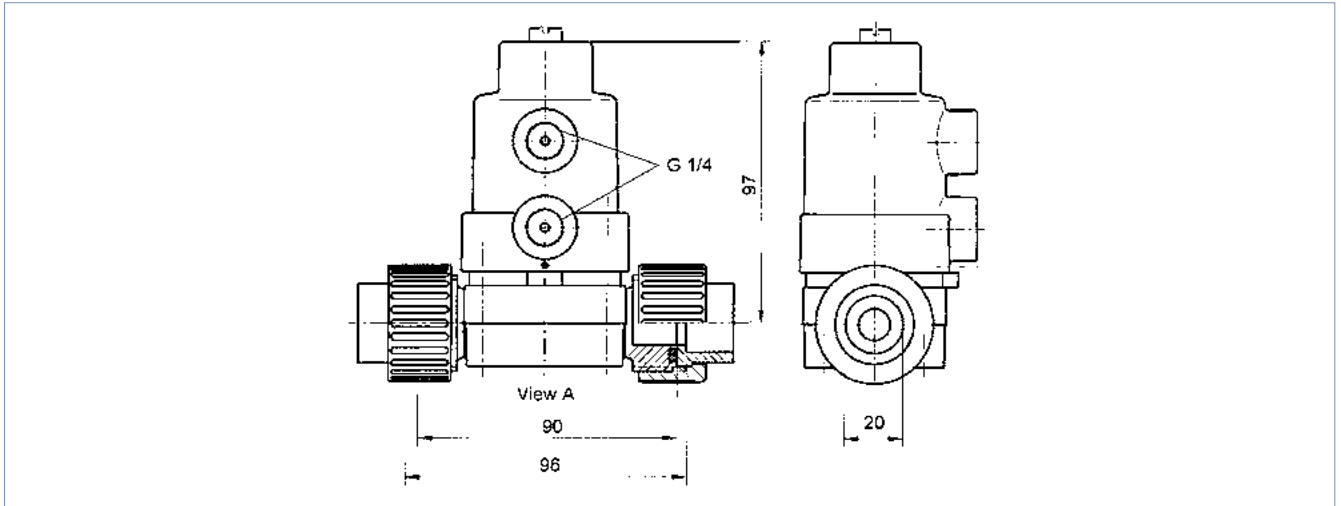

5.2. DN 12, G 3/8 threaded socket, Ø 16 glued socket connection or weld socket connection

Note:

Dimensions in mm

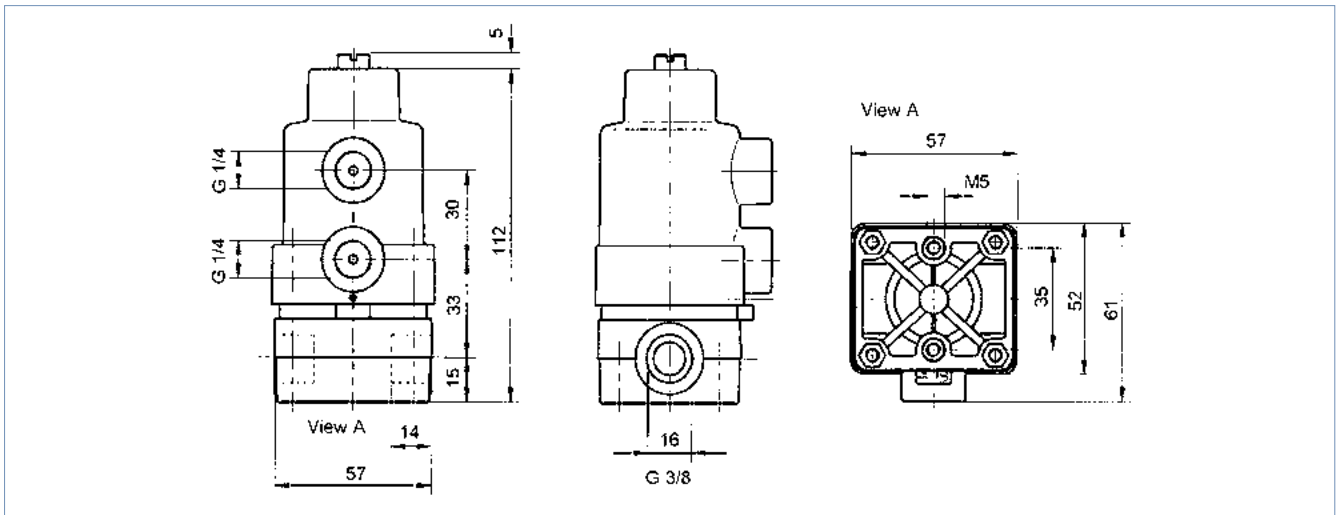

DTS 1000020595 EN Version: J Status: RL (released | freigegeben | valide) printed: 12.05.2026

6. Performance specifications

6.1. Pressure temperature diagram

Note:

Depending on the body materials

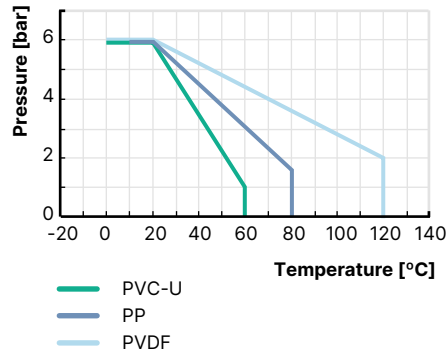

6.2. Pilot pressure diagram

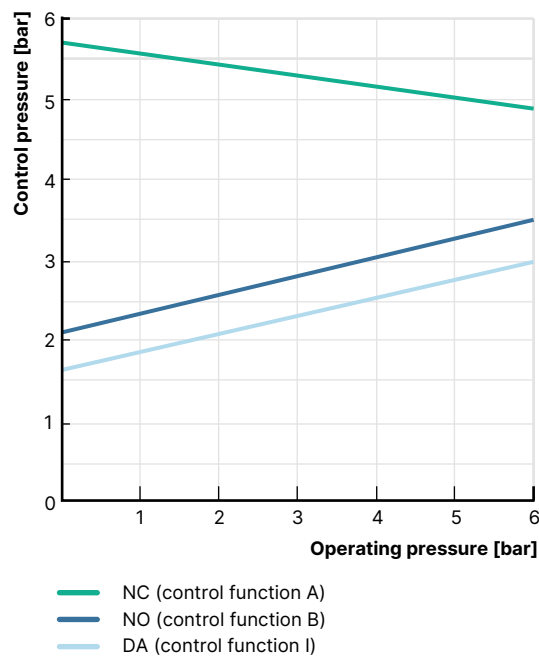

7. Ordering information

7.1. Bürkert eShop



Bürkert eShop – Easy ordering and quick delivery

You want to find your desired Bürkert product or spare part quickly and order directly? Our online shop is available for you 24/7. Sign up and enjoy all the benefits.

[Order online now](#)

7.2. Bürkert product filter



Bürkert product filter – Get quickly to the right product

You want to select products comfortably based on your technical requirements? Use the Bürkert product filter and find suitable articles for your application quickly and easily.

[Try out our product filter](#)

7.3. Ordering chart

Note:



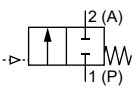
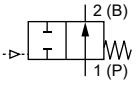



- All valves with EPDM diaphragm
- The permissible nominal pressure decreases with increasing medium temperature (see [“6.1. Pressure temperature diagram” on page 6](#)).

| Control function | Orifice | K _v value water | Pressure range at + 20 °C | Body material | Port connection | Article no. |
|---|---------|----------------------------|---------------------------|---------------|-----------------------|-------------|
| | [mm] | | | | | |
| A (CF A) Pneumatically operated 2/2-way on/off valve Flow direction above seat Normally closed by spring force  | 12 | 2.8 | 0..6 | PVC-U | Ø 16 glued socket | 784822 |
| | | | | | G 3/8 threaded socket | 784824 |
| | 15 | 3.5 | 0..6 | PVC-U | Ø 20 glued socket | 784826 |
| | | | | PP | Ø 20 true union weld | 784832 |
| B (CF B) Single-acting actuator for pneumatically operated 2/2-way on/off valve Normally opened by spring force  | 12 | 2.8 | 0..6 | PVC-U | Ø 16 glued socket | 784823 |
| | | | | | G 3/8 threaded socket | 784825 |
| | 15 | 3.5 | 0..6 | PVC-U | Ø 20 glued socket | 784827 |
| | | | | PP | Ø 20 true union weld | 784833 |

DTS 1000020595 EN Version: J Status: RL (released | freigegeben | valide) printed: 12.05.2026

7.4. Ordering chart accessories

3/2-way pilot valve Typ 7012 with plug pattern: Form B

| Pressure inlet P (valve body) | Service port A (banjo bolt) | Nominal diameter | Q _{Nn} value air | Voltage | Frequency | Electrical power | Pressure range ^{2,3,4)} | Article no. |
|--|--------------------------------|------------------|------------------------------|---------|-----------|------------------|----------------------------------|--|
| | | [mm] | [l/min] | | | [W] | [bar] | |
| G 1/8" | G 1/4" | 1.2 | 35 | 24 V | DC | 5 | 0...10 | 20082715  |
| G 1/8" | G 1/4" | 1.2 | 35 | 230 V | 50 Hz | 4 | 0...11 | 20096741  |
| Swivel connector Ø 6 mm ⁴⁾ | G 1/4" | 1.2 | 35 | 24 V | DC | 5 | 0...10 | 20083551  |
| Swivel connector Ø 6 mm ⁴⁾ | G 1/4" | 1.2 | 35 | 230 V | 50 Hz | 4 | 0...11 | 20096742  |
| G 1/4" | G 1/4" | 1.2 | 35 | 24 V | DC | 5 | 0...10 | 20078886  |
| G 1/4" | G 1/4" | 1.2 | 35 | 230 V | 50 Hz | 4 | 0...11 | 20096744  |



1.) For P1: 6 bar absolute and P2: 5 bar absolute

2.) Pressure specification: Overpressure to atmospheric pressure and medium air

3.) Number of switching cycles under laboratory conditions (FKM seal, lubricated air, unpressurised, DC): 5 million. Please note that increasing the switching pressure can reduce the service life of the seat seal.

4.) Screw-in swivel connector with Ø 6 mm push-in is supplied loose





Replacement diaphragms for all nominal diameters

| Description | Material | Article no. |
|--|---|---|
| Replacement diaphragms for all nominal diameters | EPDM | 789409  |
| | FKM | 789661  |
| | Laminate of Advanced PTFE and EPDM (EK) | 789597  |

Cable plug Type 2507 according to industry standard connector Form B

Note:

- Delivery of cable plug includes a flat seal and a fixing screw.
- Further versions of cable plug with circuitry according to industry standard connector Form B as well as detailed technical data (see datasheet **Type 2507** ).

| Cable plug | Version | Voltage | Article no. |
|---|--|-----------------|--|
|  | Cable plug 20 mm, 3-pin (2 conductors + protective conductors), form B in accordance with industry standard, standard and/or no wiring (Type 2507) | 2...250 V AC/DC | 423845  |
| | Cable plug, 20 mm, 3-pin (2 conductors + protective conductors), form B in accordance with industry standard, with LED (Type 2507) | 24 V AC/DC | 423849  |
| | Cable plug 20 mm, 3-pin (2 conductors + protective conductors), form B in accordance with industry standard, with LED and varistor (Type 2507) | 12...24 V AC/DC | 423851  |
| | Cable plug 20 mm, 3-pin (2 conductors + protective conductors), form B in accordance with industry standard, with bridge rectifier, LED and varistor (Type 2507) | 12...24 V AC/DC | 423853  |