

## Type 8691 REV.3

Control Head



## Operating Instructions

We reserve the right to make technical changes without notice.  
Technische Änderungen vorbehalten.  
Sous réserve de modifications techniques.

© Bürkert Werke GmbH & Co. KG, 2022 - 2024

Operating Instructions 2403/03\_EU-EN\_00815428 / Original DE

## Control head Type 8691 REV.3

### TABLE OF CONTENTS

<b>1</b>	<b>ABOUT THESE INSTRUCTIONS .....</b>	<b>7</b>
1.1	Symbols.....	7
1.2	Definition of terms.....	7
<b>2</b>	<b>INTENDED USE .....</b>	<b>8</b>
<b>3</b>	<b>BASIC SAFETY INSTRUCTIONS .....</b>	<b>9</b>
<b>4</b>	<b>GENERAL INFORMATION.....</b>	<b>10</b>
4.1	Contact address.....	10
4.2	Warranty .....	10
4.3	Information on the Internet.....	10
4.4	Trademarks.....	10
<b>5</b>	<b>PRODUCT DESCRIPTION.....</b>	<b>11</b>
5.1	Structure.....	11
5.1.1	Structure, integrated pilot air duct (21xx, Element) .....	11
5.1.2	Structure, external pilot air duct (20xx, Classic) .....	11
5.1.3	Variants .....	12
5.2	Function.....	12
<b>6</b>	<b>TECHNICAL DATA .....</b>	<b>13</b>
6.1	Standards and directives.....	13
6.2	Approvals .....	13
6.3	Type label .....	14
6.3.1	Type label standard .....	14
6.3.2	UL type label.....	14
6.3.3	UL additional label.....	14
6.4	Operating conditions .....	14
6.4.1	Fluidic data .....	15

6.4.2	Electrical data .....	15
6.4.2.1	Electrical data without fieldbus communication.....	15
6.4.2.2	Electrical data, IO-Link .....	16
6.4.2.3	Electrical data, bÜS.....	16
6.4.2.4	Electrical data, AS-Interface.....	17
<b>6.5</b>	<b>Mechanical data.....</b>	<b>17</b>
6.5.1	Safety end positions .....	18
<b>6.6</b>	<b>Communication.....</b>	<b>18</b>
6.6.1	IO-Link .....	18
<b>7</b>	<b>MECHANICAL INSTALLATION.....</b>	<b>19</b>
<b>7.1</b>	<b>Safety instructions .....</b>	<b>19</b>
<b>7.2</b>	<b>Installing devices with integrated pilot air duct (21xx, Element) .....</b>	<b>19</b>
<b>7.3</b>	<b>Installing devices with external control air duct (20xx, Classic).....</b>	<b>22</b>
<b>7.4</b>	<b>Aligning (turning) the device and position of connections.....</b>	<b>26</b>
7.4.1	Turning the actuator, devices with hexnut.....	27
7.4.2	Turning the actuator, devices without hexnut.....	28
7.4.3	Turning the device .....	29
<b>7.5</b>	<b>Installation on rotary actuators from third party manufacturers.....</b>	<b>30</b>
<b>8</b>	<b>PNEUMATIC INSTALLATION.....</b>	<b>31</b>
<b>8.1</b>	<b>Safety instructions .....</b>	<b>31</b>
<b>8.2</b>	<b>Connecting the device pneumatically.....</b>	<b>31</b>
<b>9</b>	<b>ELECTRICAL INSTALLATION.....</b>	<b>32</b>
<b>9.1</b>	<b>Safety instructions for electrical installation.....</b>	<b>32</b>
<b>9.2</b>	<b>Electrical installation without fieldbus communication.....</b>	<b>32</b>
9.2.1	Device with cable gland.....	32
9.2.2	Device with circular plug-in connector .....	34
<b>9.3</b>	<b>Connecting the device electrically, IO-Link, port class A .....</b>	<b>34</b>
<b>9.4</b>	<b>Connecting the device electrically, IO-Link, port class B .....</b>	<b>35</b>
<b>9.5</b>	<b>Connecting the device electrically, bÜS .....</b>	<b>35</b>
<b>9.6</b>	<b>Connecting the device electrically, AS-Interface .....</b>	<b>36</b>
<b>9.7</b>	<b>Connecting the device electrically, AS-Interface with multi-pole cable and flat cable terminal.....</b>	<b>36</b>

- 10 START-UP .....37**
  - 10.1 Invert process valve direction .....37**
  - 10.2 Teach function: Determine end positions and save these, REV.3 .....40**
    - 10.2.1 Start automatic teach function .....40
    - 10.2.2 Start manual teach function .....42
    - 10.2.3 Teach-in-operation function.....44
  - 10.3 Setting with Bürkert Communicator.....44**
    - 10.3.1 Connecting the device with Bürkert Communicator .....44
  - 10.4 IO-Link .....46**
    - 10.4.1 Information, IO-Link.....46
    - 10.4.2 Configuration of the fieldbus .....46
  - 10.5 bÜS.....46**
    - 10.5.1 Information, bÜS .....46
    - 10.5.2 Configuration of the fieldbus .....46
  - 10.6 AS-Interface .....47**
    - 10.6.1 Certification .....47
    - 10.6.2 Programming data .....47
- 11 OPERATING AND DISPLAY ELEMENTS .....48**
  - 11.1 Operating state .....50**
  - 11.2 Functions of the operating and display elements .....50**
  - 11.3 Status indicator .....53**
  - 11.4 Description of the LED modes .....53**
    - 11.4.1 Valve mode .....53
    - 11.4.2 Valve mode with error messages (valve mode + errors).....54
    - 11.4.3 Valve mode with error messages and warnings (valve mode + warnings) .....54
    - 11.4.4 NAMUR mode.....56
    - 11.4.5 Fixed colour .....56
    - 11.4.6 LED off .....56
  - 11.5 Setting the LED mode, status indicator .....57**
  - 11.6 Switching the device manually with pilot valve .....58**
- 12 MAINTENANCE .....59**
  - 12.1 Servicing the air intake filter .....59**

MAN 1000549653 EN Version: C Status: RL (released | freigegeben) printed: 06.05.2026

<b>13</b>	<b>DEINSTALLATION.....</b>	<b>60</b>
<b>13.1</b>	<b>Safety instructions deinstallation .....</b>	<b>60</b>
<b>13.2</b>	<b>Deinstallation.....</b>	<b>61</b>
<b>14</b>	<b>SPARE PARTS, ACCESSORIES.....</b>	<b>62</b>
<b>14.1</b>	<b>Communications software.....</b>	<b>62</b>
<b>15</b>	<b>TRANSPORTATION, STORAGE .....</b>	<b>63</b>

# 1 ABOUT THESE INSTRUCTIONS

The operating instructions describe the entire life cycle of the device.

→ Keep these instructions ready to hand at the operation site.

## Important safety information.

- ▶ Carefully read these instructions.
- ▶ Observe in particular the safety instructions, intended use and operating conditions.
- ▶ Persons, who work on the device, must read and understand these instructions.

## 1.1 Symbols

### **DANGER**

Warns of an immediate danger.

- ▶ Failure to observe the warning will result in a fatal or serious injury.

### **WARNING**

Warns of a potentially dangerous situation.

- ▶ Failure to observe the warning may result a fatal or serious injury.

### **CAUTION**

Warns of a possible danger.

- ▶ Failure to observe the warning may result in moderate or minor injuries.

### **NOTE**

Warns of damage to property.

- ▶ Failure to observe the warning may result in damage to device or system.

 Indicates important additional information, tips and recommendations.

 Refers to information in these operating instructions or in other documentation.

▶ Designates an instruction for risk prevention.

→ Designates a procedure which you must carry out.

 Indicates a result.

## 1.2 Definition of terms

In these instructions the term “device” denotes the following device types:

Control head Type 8691 REV.3

The term “bÜS” (Bürkert system bus) used in this instruction stands for the communication bus developed by Bürkert and based on the CANopen protocol.

## 2 INTENDED USE

The control head Type 8691 REV.3 is designed to be mounted on pneumatic actuators of process valves for the control of media. The permitted fluid media are listed in the technical data.

- ▶ Use the device for its intended purpose only. Non-intended use of the device may be dangerous to people, nearby equipment and the environment.
- ▶ Correct transportation, correct storage as well as correct installation, commissioning, operation and maintenance are essential for reliable and problem-free operation.
- ▶ When using the device, observe the permitted data, operating conditions and application conditions. This information can be found in the contractual documents, the operating instructions and on the type label.
- ▶ Use the device only in conjunction with third-party devices and components recommended and authorized by Bürkert.
- ▶ Do not use the device outdoors without protection from the weather.
- ▶ In potentially explosive atmosphere, only use devices approved for use in those areas. These devices are labeled with a separate Ex type label. For such use, note the information provided on the separate Ex type label and the additional explosion-related information or separate explosion-related operating instructions.

### 3 BASIC SAFETY INSTRUCTIONS

These safety instructions do not consider any contingencies or incidents which occur during installation, operation and maintenance.

The operator is responsible for observing the location-specific safety regulations, also with reference to the personnel.

#### **DANGER**

**Risk of injury from high pressure and discharge of medium.**

- ▶ Before working on the device or system, switch off the pressure. Vent or drain lines.

#### **DANGER**

**Risk of injury from electric shock.**

- ▶ Before working on the device or system, switch off the power supply. Secure against reactivation.
- ▶ Observe applicable accident prevention and safety regulations for electrical equipment.



**To prevent injury, ensure the following:**

- ▶ Secure device or system to prevent unintentional activation.
- ▶ Only trained technicians may perform installation and maintenance work.
- ▶ Perform installation and maintenance with suitable tools only.
- ▶ Do not make any changes to the device and do not subject it to mechanical stress.
- ▶ Operate the device only in perfect state and in consideration of the operating instructions.
- ▶ Observe the general rules of technology.
- ▶ Install the device according to the regulations applicable in the respective country.
- ▶ Do not feed corrosive or flammable media into the device connections.
- ▶ Do not feed any fluids into the connections of the device.
- ▶ After the process is interrupted, restart in a controlled manner. Observe sequence:
  1. Connect electrical or pneumatic power supply.
  2. Charge the device with medium.
- ▶ Observe intended use.

## 4 GENERAL INFORMATION

### 4.1 Contact address

#### Germany

Bürkert Fluid Control System  
Chr.-Bürkert-Str. 13-17  
D-74653 Ingelfingen  
E-mail: info@burkert.com

#### International

Contact addresses can be found on the final pages of the printed operating instructions.

Also in the internet at:

[www.burkert.com](http://www.burkert.com)

### 4.2 Warranty

The warranty is only valid if the device is used as intended in accordance with the specified application conditions.

### 4.3 Information on the Internet

The operating instructions and data sheets for Bürkert products can be found on the Internet at:

[www.burkert.com](http://www.burkert.com)

### 4.4 Trademarks

The brands listed below are trademarks of the corresponding companies / associations or organizations.

Loctite      Henkel Loctite Deutschland GmbH

## 5 PRODUCT DESCRIPTION

### 5.1 Structure

The modular design of the device supports various configurations and variants.

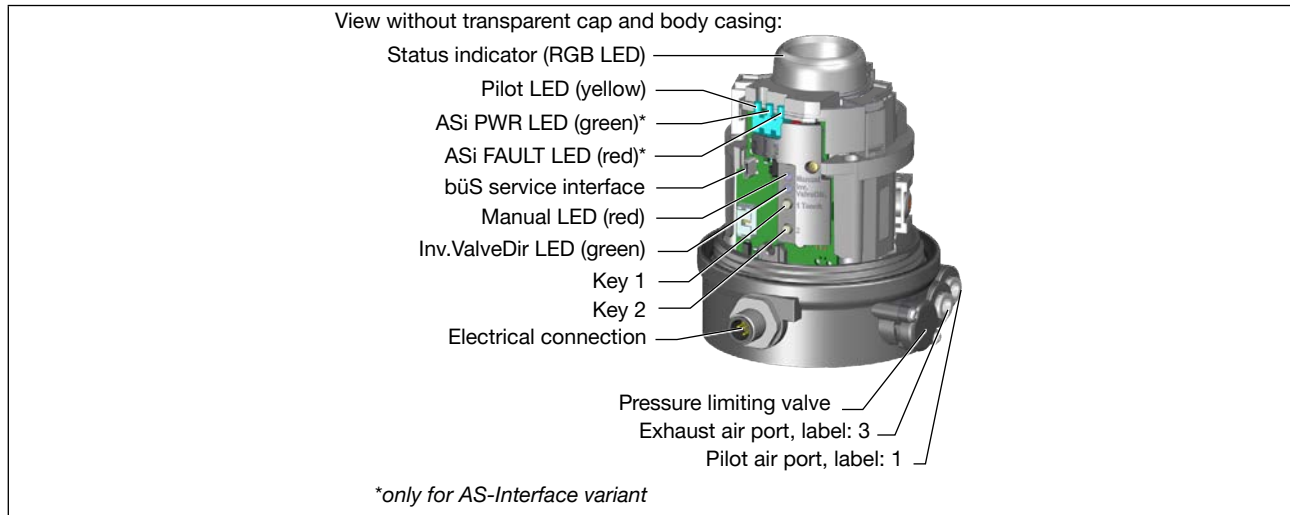

Figure 1: Structure

#### 5.1.1 Structure, integrated pilot air duct (21xx, Element)

The structure with integrated pilot air duct is optimized for mounting on process valves of the 21xx series (Element).

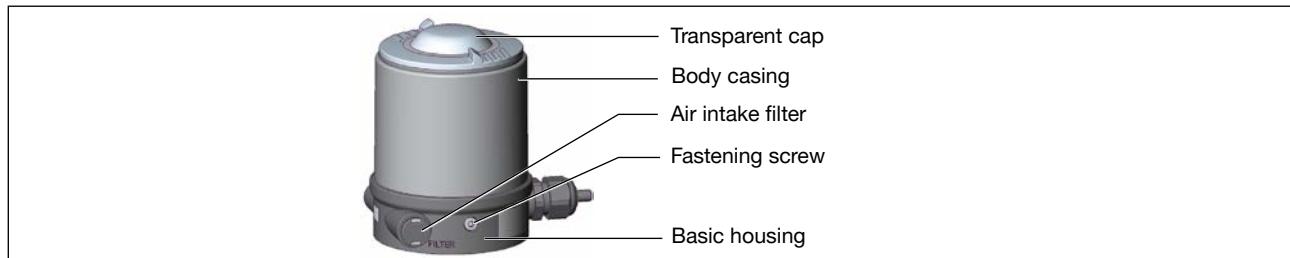

Figure 2: Structure, integrated pilot air duct

#### 5.1.2 Structure, external pilot air duct (20xx, Classic)

The structure with external pilot air duct is optimized for mounting on process valves of the 20xx series (Classic).

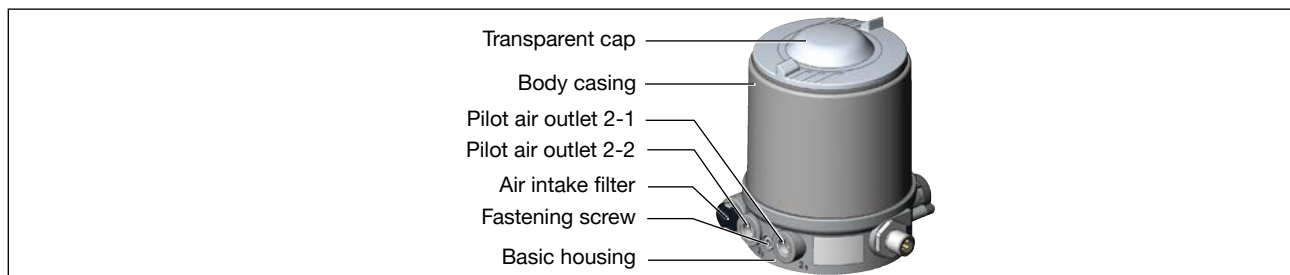

Figure 3: Structure, external pilot air duct

So that the pilot air can be externally connected to the actuator, this structure has a different basic housing.

### 5.1.3 Variants

Communication possible via:

- without fieldbus communication: 24 V device with digital inputs and outputs and büS service interface
- AS Interface
- IO-Link
- büS

## 5.2 Function

This device is capable of controlling single-acting and double-acting process valves.

The pilot valves can be manually overridden.

An analog, inductive sensor element provides feedback about end positions being reached. The teach function is used for configuration.

Colored LEDs indicate the device status.

## 6 TECHNICAL DATA

### 6.1 Standards and directives

The device complies with the relevant EU harmonisation legislation. In addition, the device also complies with the requirements of the laws of the United Kingdom.

The harmonised standards that have been applied for the conformity assessment procedure are listed in the current version of the EU Declaration of Conformity/UK Declaration of Conformity.

### 6.2 Approvals

The product is approved for use in zone 2 and 22 in accordance with ATEX directive 2014/34/EU category 3GD.



**Observe instructions on operation in the potentially explosive atmosphere. See additional explosion-related information.**

The product is cULus approved. Instructions on operation in the UL area see chapter “Electrical data”.

## 6.3 Type label

### 6.3.1 Type label standard

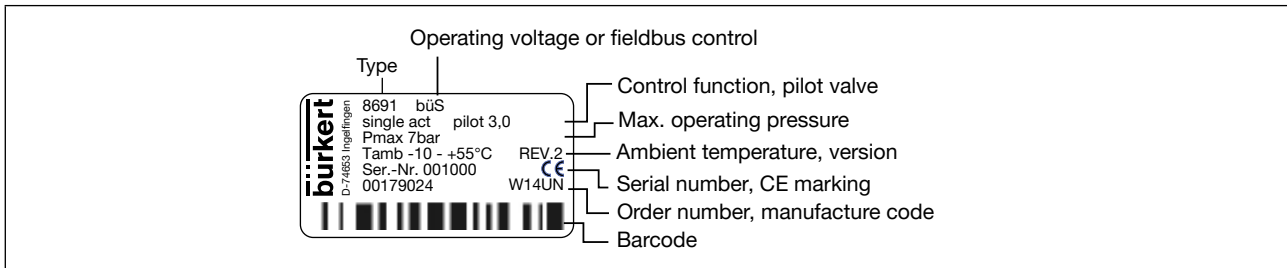

Figure 4: Type label standard (example)

### 6.3.2 UL type label

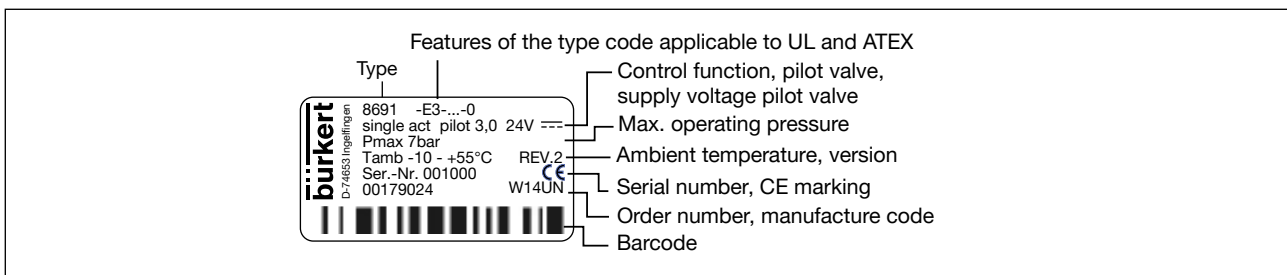

Figure 5: UL type label (example)

### 6.3.3 UL additional label

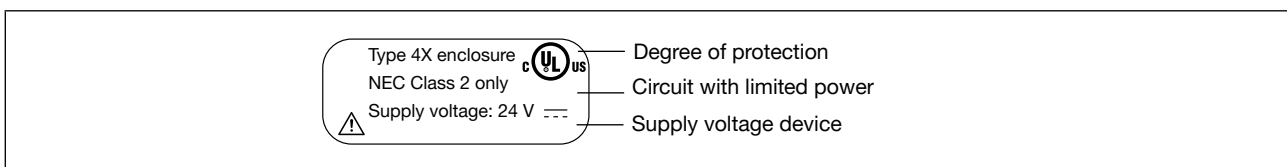

Figure 6: UL additional label (example)

## 6.4 Operating conditions

Ambient temperature	See type label
Degree of protection	
Evaluated by manufacturer:	IP65, IP67 as per EN 60529*
Evaluated by UL:	UL type 4x Rating, indoor only*
Operating altitude	up to 2000 m above sea level
Relative air humidity	max. 90% at 55 °C (non condensing)

\* Only if cables, plugs and sockets have been connected correctly and in compliance with the exhaust air concept see chapter "Pneumatic installation".

## 6.4.1 Fluidic data

Control medium	Neutral gases, air Quality classes as per ISO 8573-1
Dust content Class 7	Max. particle size 40 µm, max. particle density 10 mg/m <sup>3</sup>
Water content class 3	Max. pressure dew point -20°C or min. 10°C below lowest operating temperature
Oil content Class X	Max. 25 mg/m <sup>3</sup>
Pressure range	3...7 bar
Temperature range	-10...+50 °C
Pilot valve air flow rate	250 l <sub>N</sub> / min (for aeration and deaeration) (Q <sub>Nn</sub> - value according to definition for pressure drop from 7 to 6 bar absolute)
Connections	Internal thread G 1/8 "

## 6.4.2 Electrical data

### NOTE

For variants with cULus approval, please note:

- ▶ Only use circuits of limited power as per UL NEC Class 2.

### 6.4.2.1 Electrical data without fieldbus communication

Protection class	III as per DIN EN 61140 (VDE 0140-1)
Connection	
Supply	Cable gland M16 x 1.5, wrench size 22 (clamping area 5...10 mm) with screw-type terminals for cable cross-sections 0.14...1.5 mm <sup>2</sup> Circular plug-in connector (M12 x 1, 8-pin)
Communication	büS service interface
Operating voltage	24 V $\pm$ 25 %, max. residual ripple 10 %
Current consumption	90 mA @18 V $\pm$ + current load for an active digital output
Digital output	2 x 24 V $\pm$ PNP (standard variant, optionally also as NPN)
Output current	max. 100 mA per output
Output voltage	Low = GND + max. 2 V and High = operating voltage - max. 2 V
Digital input	24 V $\pm$ potential-free (suitable for PNP and NPN control)
Output current	max. 9 mA @30 V $\pm$ (as per EN 61131-2 Type 1)
Output voltage	Low = 0...5 V $\pm$ and High = 15...30 V $\pm$ (as per EN 61131-2 Type 1)
Power consumption incl. load on one active digital output	2 W / 5 W
Communication software	Bürkert Communicator

### 6.4.2.2 Electrical data, IO-Link

Protection class	III as per DIN EN 61140 (VDE 0140-1)
Connection	
Supply, IO-Link	Circular plug-in connector M12 x 1, 4-pin, port class A Circular plug-in connector M12 x 1, 5-pin, port class B
Communication	büS service interface
Operating voltage	
System supply (Pin 1+3)	24 V $\pm$ 25 % (according to specification)
only for port class B:	
Actuator supply (Pin 2+5)*	24 V $\pm$ 25 % (according to specification)
Current consumption	
System supply (Pin 1+3)	For port class A max. 150 mA (only with installed pilot valves) For port class B max. 100 mA
only for port class B:	
Actuator supply (Pin 2+5)	max. 50 mA
Communication software	Bürkert Communicator

---

*\*Actuator supply is galvanically isolated from system supply in accordance with IEC 60664 and for electrical safety in accordance with SELV from IEC 61010-2-201*

### 6.4.2.3 Electrical data, büS

Protection class	III as per DIN EN 61140 (VDE 0140-1)
Connection	Circular plug-in connector M12 x 1, 5-pin
Operating voltage	18...30 V $\pm$ (according to specification)
Max. current consumption	120 mA @18 V (incl. inrush current pilot valve for 200 ms)
Current consumption input during normal operation	95 mA @18 V
(after current reduction, pilot valve after 200 ms and 1 end position reached)	

#### 6.4.2.4 Electrical data, AS-Interface

Protection class	III as per DIN EN 61140 (VDE 0140-1)
Connection	
Supply, AS-Interface	Circular plug-in connector M12 x 1, 4-pin
Communication	büS service interface
Operating voltage	
System supply AS-Interface (Pin 1+3)	via AS-Interface power supply unit according to specification with 29.5 V...31.6 V $\overline{=}$
only for variant with additional actuator supply (AUX Power) (Pin 2+4)*	24 V $\overline{=}$ $\pm 10\%$
Power consumption	
Output pilot valve	approx. 0.8 W incl. integrated watchdog function
Current consumption	
System supply (Pin 1+3)	Without additional actuator supply and installed pilot valve max. 110 mA
	With additional actuator supply (AUX power) or without pilot valve max. 60 mA @23 V $\overline{=}$
only with additional actuator supply (AUX Power) (Pin 2+4)	max. 50 mA @24 V $\pm 10\%$
Communication software	Bürkert Communicator

\* The power supply unit must include a secure disconnection in accordance with IEC 364-4-41 (PELV or SELV)

## 6.5 Mechanical data

Dimensions	See data sheet
Body material	
exterior:	PPS, PC, VA
Seal material	
external:	EPDM
internal:	NBR
Stroke range of valve spindle	2...47 mm

## 6.5.1 Safety end positions

Safety end positions after failure of the electrical or pneumatic auxiliary power:

Actuator system	Designation	Safety end positions after failure of the auxiliary power	
		electrical	pneumatic
	single-acting control function A	down	down
	single-acting control function B	up	up
	double-acting control function I	down	not defined

Table 1: Safety end positions

## 6.6 Communication

### 6.6.1 IO-Link

Port class	A	B
IO-Link specification	V1.1.2	
Supply	via IO-Link (M12 x 1, 5-pin, A-coded)	
SIO-Mode	No	
IODD-File	see internet	
VendorID	0x0078, 120	
DeviceID	see IODD file	
ProductID	8691 Class A	8691 Class B
Transmission speed	COM3 (230,4 kbit/s)	
PD Input Bits	56	
PD Output Bits	8	
M-sequence Cap.	0x0D	
Min. cycle time	5 ms	
Data storage	Yes	
Max. cable length	20 m	

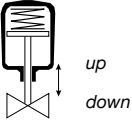
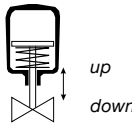
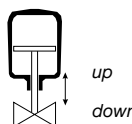
## 7 MECHANICAL INSTALLATION

### 7.1 Safety instructions

 **DANGER**

Risk of injury from high pressure and discharge of medium.

- ▶ Before working on the device or system, switch off the pressure. Vent or drain lines.

 **WARNING**

Risk of injury from improper installation.

- ▶ Only trained technicians may perform installations.
- ▶ Perform installations with suitable tools only.

 **WARNING**

Risk of injury due to unintentional activation and uncontrolled start-up of the system.

- ▶ Secure system against unintentional activation.
- ▶ Ensure that the system does not start up in an uncontrolled manner.

### 7.2 Installing devices with integrated pilot air duct (21xx, Element)

 Only for devices without preinstalled process valve.

Required attachment kit: ELEMENT Type 21xx

#### NOTE

Damage to the device and the actuator when welding bodies.

Observe the following during installation on process valves with welded connection:

- ▶ Observe the installation instructions for the operating manual of the process valve.
- ▶ Before installing the device, weld the process valve into the pipe system.

## 1. Installing the switch spindle

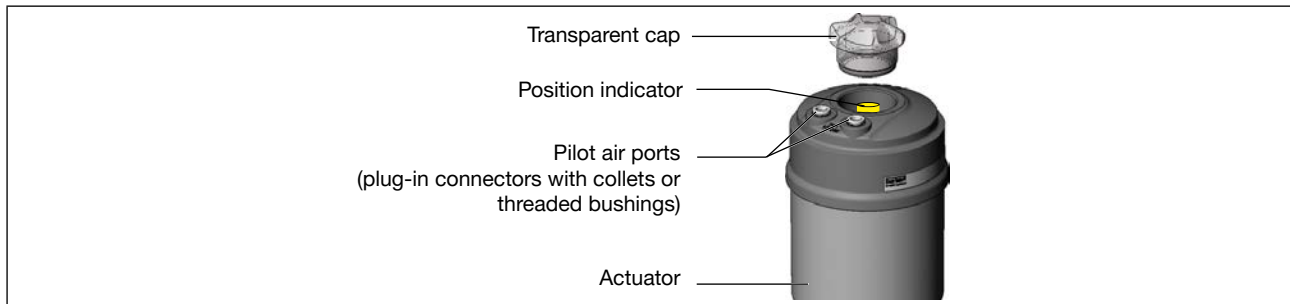

Figure 7: Installing the switch spindle (1), integrated pilot air duct

- Unscrew the transparent cap from the actuator.
- Unscrew position indicator from spindle extension.
- For variant with hose connector: remove the collets (white sleeves) from the pilot air ports.

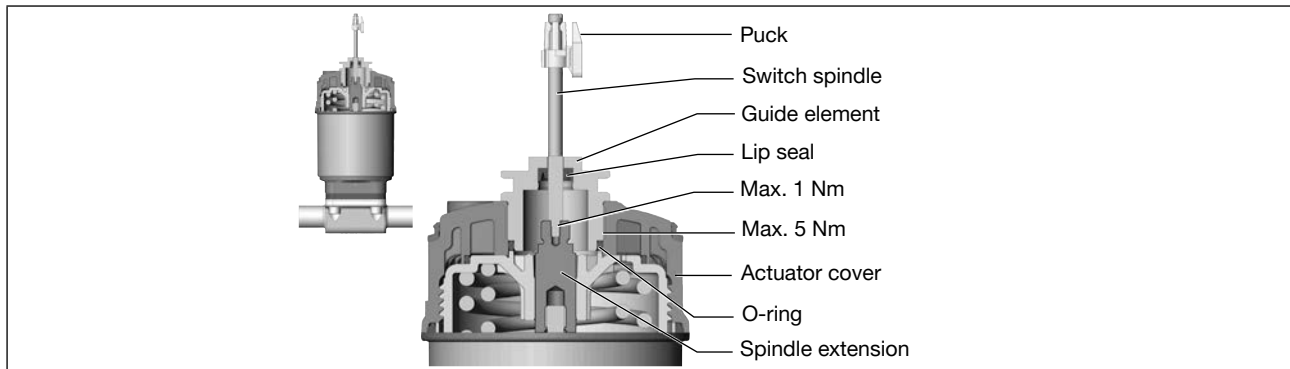

Figure 8: Installing the switch spindle (2), integrated pilot air duct

### NOTE

**Lip seal can be damaged if incorrectly installed.**

The lip seal is pre-mounted in the guide element and must be "locked into position" in the undercut.

- ▶ When installing the switch spindle, do not damage the lip seal.

- Slide switch spindle through the guide element.

### NOTE

**Contamination of the lip seal due to screw locking paint.**

- ▶ Do not apply any screw locking paint to the switch spindle.

- To secure the switch spindle, apply some screw locking paint (e.g. Loctite 290) in the threading of the spindle extension in the actuator.
- Check that the O-ring is in the correct position.
- Screw guide element in actuator cover (tightening torque: max. 5 Nm).
- Screw switch spindle onto the spindle extension. A slot is provided on the top side (tightening torque: max. 1 Nm).
- Push puck onto the switch spindle and lock into position.

## 2. Attaching the form seal

- Pull the form seal onto the actuator cover (smaller diameter points upwards).
- Check that the O-rings are correctly positioned in the pilot air ports.

**!** Before installing the device, remove the collets in the pilot air ports.

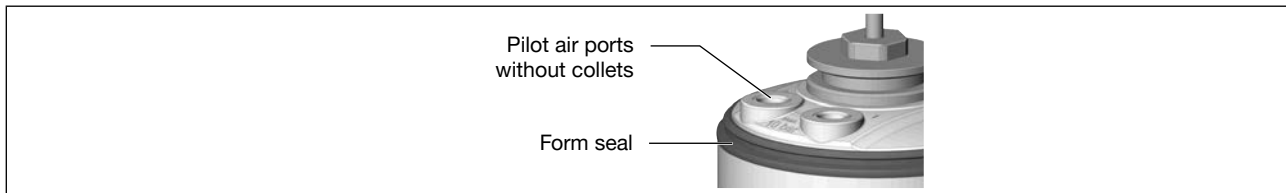

Figure 9: Attaching the form seal

## 3. Installing the device

### NOTE

#### Damage or functional outage of the PCB

- ▶ Ensure that the puck lies flat in the guide rail.

→ Align the puck and device so that:

1. The puck rests in the guide rail of the device (see Fig. below).
2. Find the connection pieces of the device into the pilot air ports of the actuator (see second Fig. below).

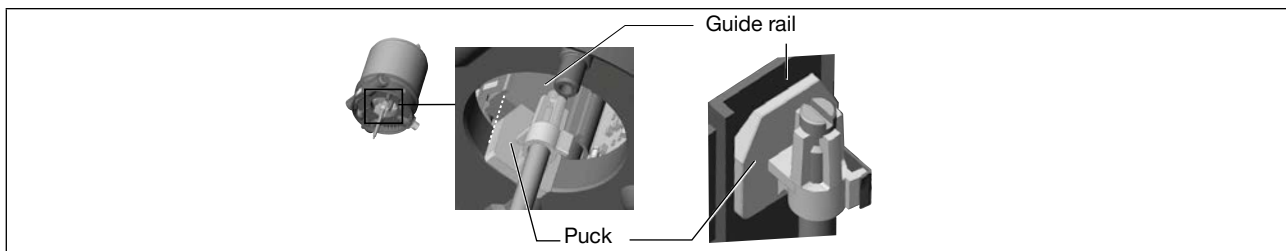

Figure 10: Aligning the puck

→ Push the device without turning it onto the actuator until no gap is visible on the form seal.

### NOTE

#### Damage or malfunction due to ingress of dirt or moisture.

To observe the degree of protection IP65 or IP67:

- ▶ Tighten fastening screws only with a tightening torque of max. 1.5 Nm.

→ Attach device to the actuator using the two side fastening screws. In doing so, tighten the screws only hand-tight (max. torque: 1.5 Nm).

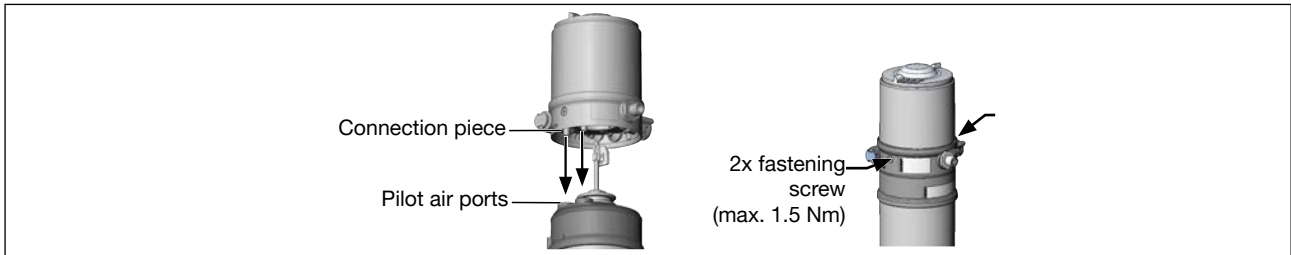

Figure 11: Installation

## 7.3 Installing devices with external control air duct (20xx, Classic)

**!** Only for devices without preinstalled process valve.

Required attachment kit: Classic Type 20xx for the corresponding variant

### NOTE

**Damage to the device and the actuator when welding bodies.**

Observe the following during installation on process valves with welded connection:

- ▶ Observe the installation instructions for the operating manual of the process valve.
- ▶ Before installing the device, weld the process valve into the pipe system.

### 1. Installing switch spindle

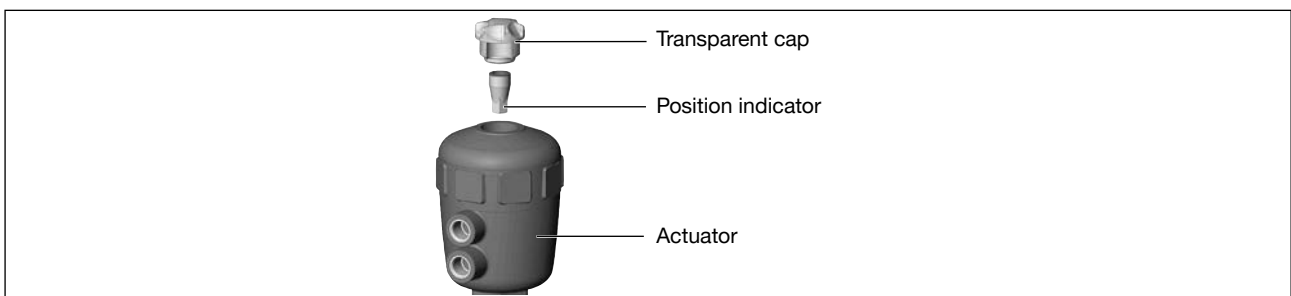

Figure 12: Installing the switch spindle (1), external pilot air duct

→ Unscrew the transparent cap from the actuator.

→ Unscrew the position indicator of the spindle with hex key.

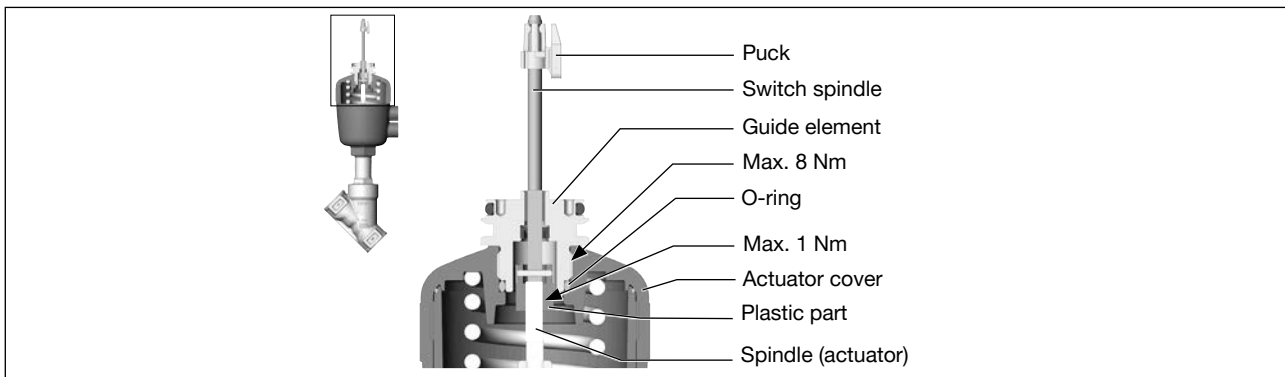

Figure 13: Installing the switch spindle (2), external pilot air duct

- Press O-ring down into the actuator cover.
- Manually screw the switch spindle (and the slipped over guide element) to the spindle of the actuator with the plastic part and do not tighten initially.
- Screw the guide element into the cover of the actuator with a face pin wrench\* (tightening torque: max. 8 Nm).
- Tighten the switch spindle on the spindle of the actuator. A slot is provided on the top side (tightening torque: max. 1 Nm).
- Push puck onto the switch spindle and lock into position.

## 2. Installing the device

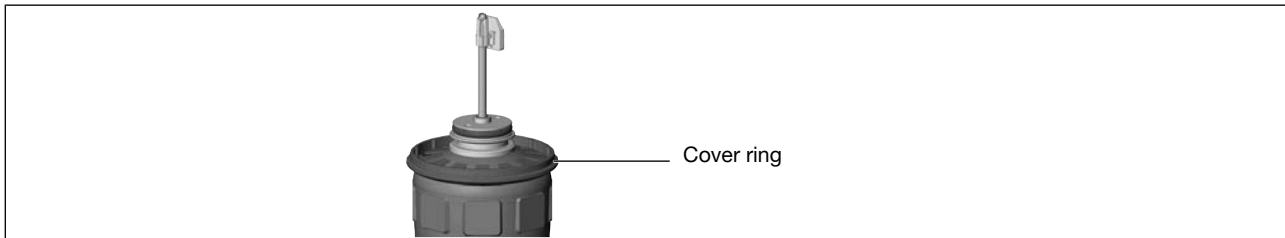

Figure 14: Attaching cover ring

- Wind cover ring onto actuator cover (only for actuator size  $\varnothing 50$  and  $\varnothing 63$ ).

### NOTE

#### Damage or functional outage of the PCB

- ▶ Ensure that the puck lies flat in the guide rail.

- Align the puck and the device so that the puck rests in the guide rail of the device (see following figure).

\* journal  $\varnothing$ : 3 mm; journal gap: 23.5 mm

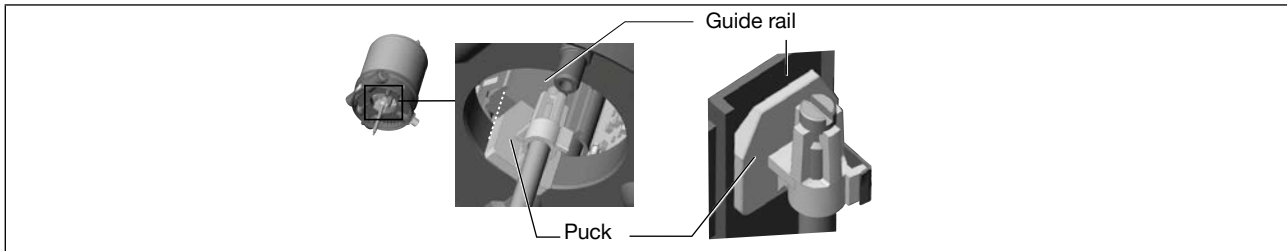

Figure 15: *Aligning the puck*

→ Press the device all the way down to the actuator and turn it into the required position.

**!** Ensure that the pneumatic connections of the device and those of the valve actuator are situated preferably vertically one above the other (see Fig. below). For different positioning, longer hoses may be required than those supplied in the attachment kit.

## NOTE

**Damage or malfunction due to ingress of dirt or moisture.**

To observe the degree of protection IP65 or IP67:

▶ Tighten fastening screws only with a tightening torque of max. 1.5 Nm.

→ Attach device to the actuator using the two side fastening screws. In doing so, tighten the screws only hand-tight (max. torque: 1.5 Nm).

## 3. Pneumatically connecting device and actuator

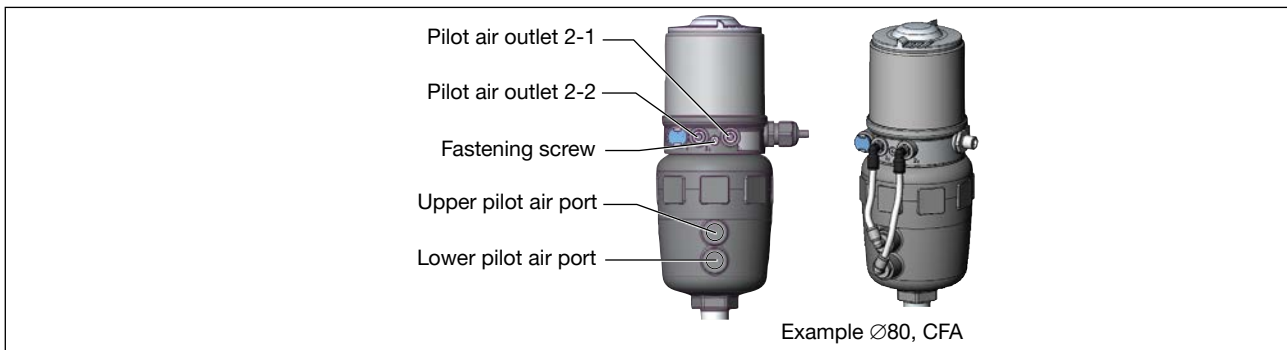

Figure 16: *Pneumatically connecting device and actuator*

→ Screw plug-in hose connector onto device and actuator.

→ Using the hoses supplied in the attachment kit, make the pneumatic connection between the device and actuator with the following table.

## NOTE

**Damage or malfunction due to ingress of dirt or moisture.**

To observe the degree of protection IP65 or IP67:

▶ Only for CFA and CFB: Connect the pilot air outlet which is not required to the free pilot air port of the actuator or seal with a plug.

<b>Control function A (CFA)</b> Process valve closed in resting position (by spring force)				
Device	Pilot air outlet		or	
Actuator	Upper pilot air port			
	Lower pilot air port			
<b>Control function B (CFB)</b> Process valve open in resting position (by spring force)				
Device	Pilot air outlet		or	
Actuator	Upper pilot air port			
	Lower pilot air port			

Table 2: Pneumatically connecting device and actuator CFA and CFB

<b>Control function I (CFI)</b> Process valve closed in resting position				
Device	Pilot air outlet			
Actuator	Upper pilot air port			
	Lower pilot air port			
<b>Control function I (CFI)</b> Process valve open in resting position				
Device	Pilot air outlet			
Actuator	Upper pilot air port			
	Lower pilot air port			

Table 3: Pneumatically connecting device and actuator CFI

- "In rest position" means that the pilot valves of the device are isolated and not actuated.
- If the ambient air is humid, a hose can be connected between pilot air outlet 2<sub>2</sub> of the device and the unconnected pilot air port of the actuator for control function A and control function B. As a result, the spring chamber of the actuator is supplied with dry air from the pilot air outlet of the device.

## 7.4 Aligning (turning) the device and position of connections



### Devices with integrated pilot air duct:

Alignment of device and position of connections is only possible with 2100, 2101 and 2106 process valves.

The device and position of the connections can be aligned by:

- turning the actuator



### Devices with external pilot air duct:

The device and position of the connections can be aligned by:

- turning the actuator (only types 2000, 2002, 2006 and 2012)
- turning the device

## 7.4.1 Turning the actuator, devices with hexnut



The following description only applies for devices with hexnut on the actuator.

For devices without a hexnut on the actuator: refer to the section "Turning the actuator, devices without hexnut" in the operating instructions.

The position of the connections can be infinitely adjusted by rotating the actuator through 360°.



Figure 17: Turning the actuator (1)

→ Clamp the valve body into a holding device (only for valves not yet installed).

### NOTE

**Damage to the seat seal or the seat contour.**

▶ When turning the actuator, the valve must be open.

→ For control function A and I\*:

Apply compressed air to pilot air port 1.

→ Switching the device manually with pilot valve (see chapter).

→ Using a suitable open-end wrench, counter the wrench flat on the body connection.

→ Place a suitable open-end wrench on the hexagonal bolt of the actuator.



### DANGER

**Risk of injury from high pressure and discharge of medium.**

If the direction of rotation is wrong, the body connection may become detached.

▶ Only turn the actuator in the prescribed direction.

→ Move the actuator to the required position by **turning it counter-clockwise** (viewed from below).

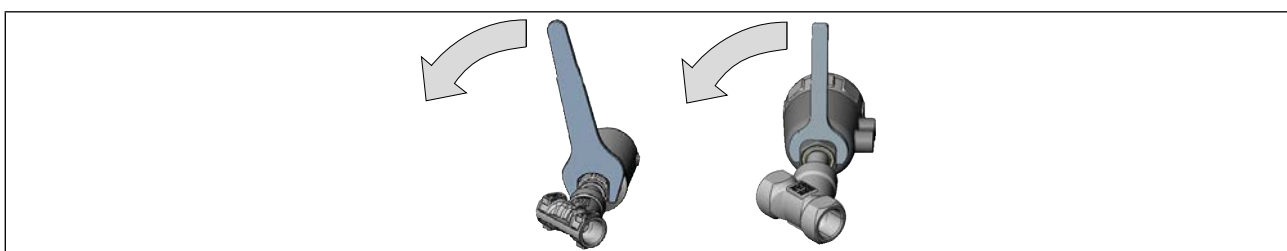

Figure 18: Turning the actuator (2)

\* if variant exists

## 7.4.2 Turning the actuator, devices without hexnut

The position of the connections can be infinitely adjusted by rotating the actuator through 360°.

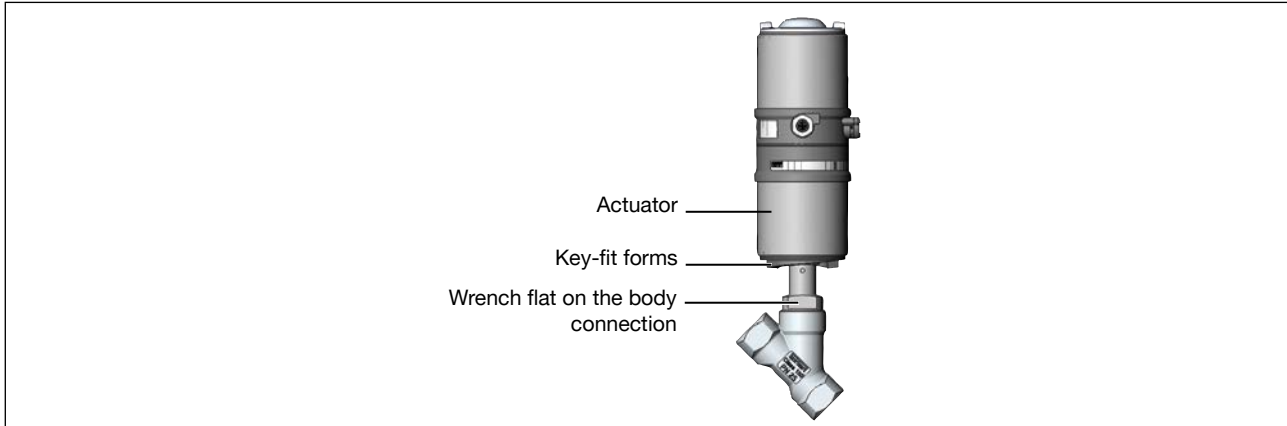

Figure 19: Turning the actuator (1), devices without hexnut

→ Clamp the valve body into a holding device (only for valves not yet installed).

### NOTE

**Damage to the seat seal or the seat contour.**

▶ When turning the actuator, the valve must be open.

→ For control function A and I\*: Apply compressed air to pilot air port 1.

→ Switching the device manually with pilot valve (see chapter).

→ Using a suitable open-end wrench, counter the wrench flat on the body connection.

→ Use a special wrench\*\* precisely in the key-fit forms of the actuator.

### **!** DANGER

**Risk of injury from high pressure and discharge of medium.**

If the direction of rotation is wrong, the body connection may become detached.

▶ Only turn the actuator in the prescribed direction.

→ By rotating in a clockwise direction (viewed from below), move the actuator to the desired position.

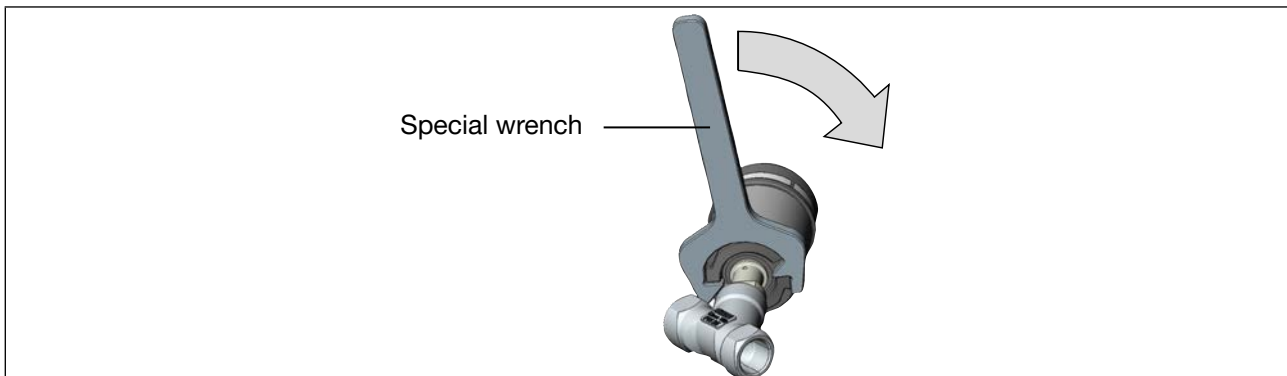

Figure 20: Turning the actuator (2), devices without hexnut

\* if variant exists

\*\* Special wrench see accessories.

### 7.4.3 Turning the device

**!** Only for devices with external pilot air duct (20xx, Classic).

The position of the connections can be aligned by rotating the device continuously through 360°.

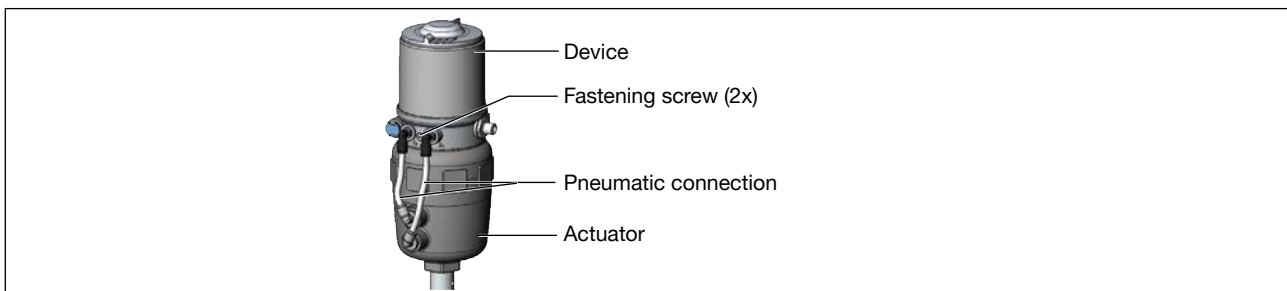

Figure 21: Turning the device

- Loosen pneumatic connection between device and actuator.
- Release fastening screws (hex socket bolt SW2.5).
- Rotate the device into the required position.

#### NOTE

**Damage or malfunction due to ingress of dirt or moisture.**

To observe the degree of protection IP65 or IP67:

- ▶ Tighten fastening screws only with a tightening torque of max. 1.5 Nm.
- ▶ Screw in body casing to the stop.
- ▶ Screw in transparent cap to the stop.
- ▶ Only for CFA and CFB: Connect the pilot air outlet which is not required to the free pilot air port of the actuator or seal with a plug.

- Only tighten the fastening screws until they are hand-tight (max. torque: 1.5 Nm).
- Re-establish pneumatic connections between device and actuator. If necessary, use longer hoses.

## 7.5 Installation on rotary actuators from third party manufacturers

- Align actuator and device to each other (see installation instructions for the adaptation set).
- Connect magnetic encoder to actuator shaft and attach using setscrew (maximum tightening torque: 0.5 Nm).
- Place angle of rotation sensor on magnetic encoder (attachment is with the adaptation set; see associated installation instructions).

### NOTE

#### Damage to the sensor cable.

- ▶ Ensure that the sensor cable is not damaged during assembly.

- Press down the device as far as the actuator.

### NOTE

#### Damage or malfunction due to ingress of dirt or moisture.

To observe the degree of protection IP65 or IP67:

- ▶ Tighten fastening screws only with a tightening torque of max. 0.5 Nm.

- Attach the device to the actuator using both lateral fastening screws. In doing so, tighten the screws only lightly (maximum tightening torque: 0.5 Nm).

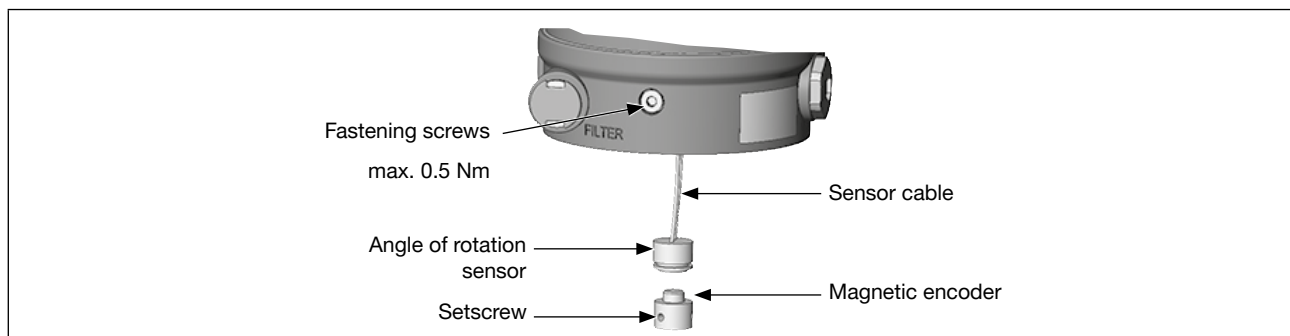

Figure 22: Installation on rotary actuators

- ⚠ The angle of rotation sensor is suitable for rotary actuators with a maximum control speed of up to 90°/0.4 s. At higher control speeds, this affects the accuracy of the valve diagnostics (e.g. the switching time measurement becomes inaccurate).

## 8 PNEUMATIC INSTALLATION

### 8.1 Safety instructions

#### DANGER

Risk of injury from high pressure and discharge of medium.

- ▶ Before working on the device or system, switch off the pressure. Vent or drain lines.

#### WARNING

Risk of injury from improper installation.

- ▶ Only trained technicians may perform installations.
- ▶ Perform installations with suitable tools only.

#### WARNING

Risk of injury due to unintentional activation and uncontrolled start-up of the system.

- ▶ Secure system against unintentional activation.
- ▶ Ensure that the system does not start up in an uncontrolled manner.

### 8.2 Connecting the device pneumatically

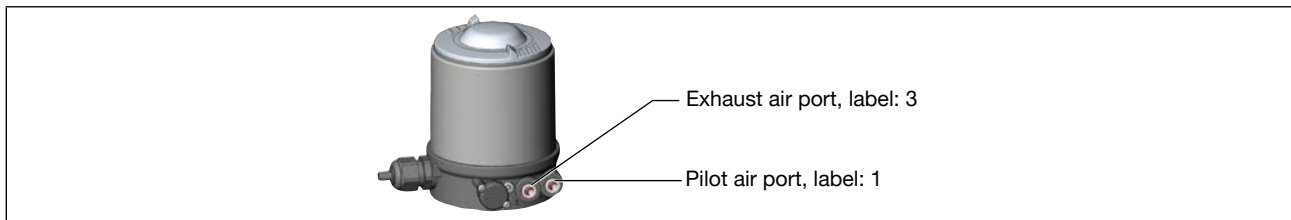

Figure 23: Connecting the device pneumatically

#### Important information for the problem-free functioning of the device:

- ▶ The installation must not cause back pressure to build up.
- ▶ Select a hose with sufficient cross section for the connection.
- ▶ Design the exhaust air line in such a way that no water or other liquid can get into the device through the exhaust air port.
- ▶ The pressure supply must always be at least 0.5–1 bar above the pressure required to bring the actuator into its end position.

→ Connect the control medium to the pilot air port (1)  
(3–7 bar, instrument air, oil-free, anhydrous and dust-free).

→ Connect the exhaust air line or a silencer to the exhaust air port (3).

#### Exhaust air system:

- ▶ To maintain the IP67 degree of protection, install an exhaust air line in the dry area.

## 9 ELECTRICAL INSTALLATION

### 9.1 Safety instructions for electrical installation

#### **DANGER**

Risk of injury from electric shock.

- ▶ Before working on the device or system, switch off the power supply. Secure against reactivation.
- ▶ Observe applicable accident prevention and safety regulations for electrical equipment.

#### **WARNING**

Risk of injury from improper installation.

- ▶ Only trained technicians may perform installations.
- ▶ Perform installations with suitable tools only.

#### **WARNING**

Risk of injury due to unintentional activation and uncontrolled start-up of the system.

- ▶ Secure system against unintentional activation.
- ▶ Ensure that the system does not start up in an uncontrolled manner.

Minimum temperature rating of the cable to be connected to the field wiring terminals: 75 °C

### 9.2 Electrical installation without fieldbus communication

#### 9.2.1 Device with cable gland

##### **NOTE**

Breakage of the pneumatic connection pieces due to rotational impact.

- ▶ When unscrewing and screwing in the body casing, do not hold the actuator of the process valve but the basic housing.

→ Unscrew the body casing (stainless steel) in an anticlockwise direction.

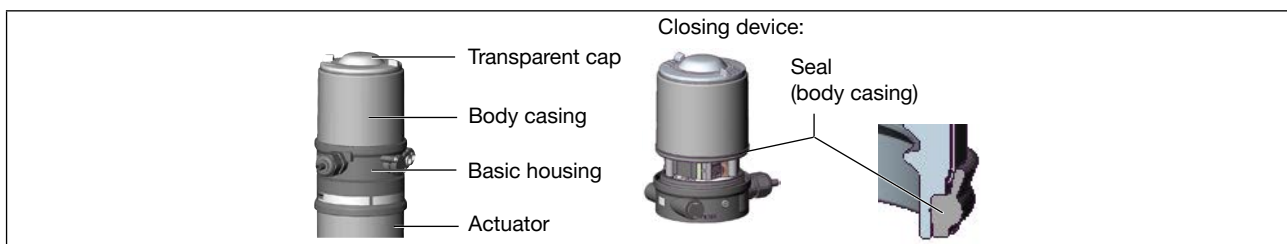

Figure 24: Opening or closing the device

→ Push the cables through the cable gland.

→ Connect the wires.

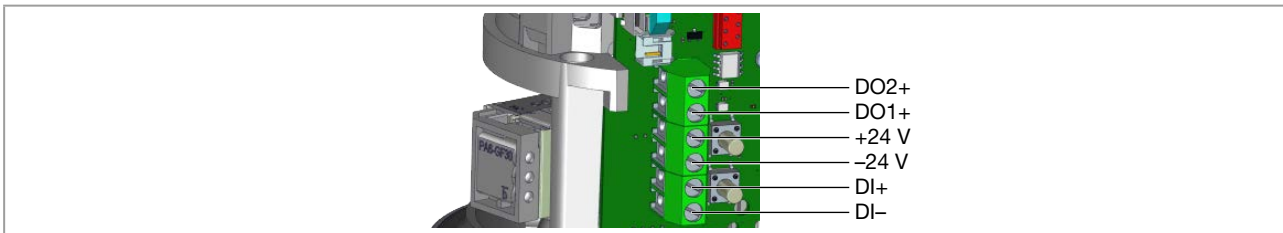

Figure 25: Connection terminals

Pin	Assignment
DO2+	Digital output end position with actuator activated
DO1+	Digital output end position with actuator deactivated
+24 V	Operating voltage +24 V
-24 V	Operating voltage GND
DI+	Digital input valve control +
DI-	Digital input valve control -

Table 4: Connection terminals

## NOTE

**Damage or malfunction due to ingress of dirt or moisture.**

To observe the degree of protection IP65 or IP67:

- ▶ Tighten the union nut on the cable gland according to the cable size or dummy plugs used. (ca. 1.5 Nm).
- ▶ Screw in body casing to the stop.

→ Tighten union nut on the cable gland (torque approx. 1.5 Nm).

→ Check that the seal is correctly positioned in the body casing.

→ Close the device (see accessories for assembly tool).

## 9.2.2 Device with circular plug-in connector

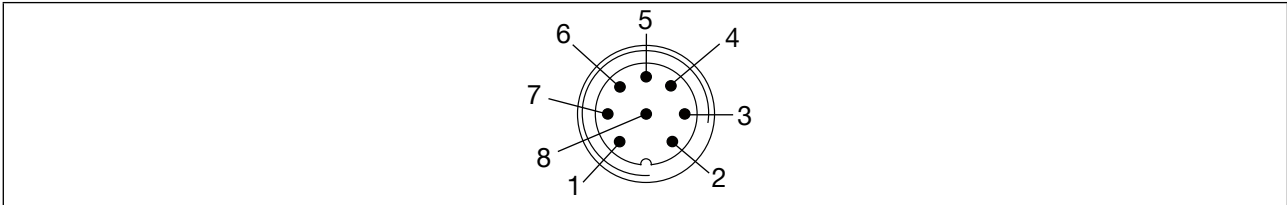

Figure 26: Pin assignment circular plug (M12 x 1, 8-pin)

Pin	Wire color*)	Designation
1	white	Digital output (DO2+) end position with actuator activated
2	brown	Digital output (DO1+) end position with actuator deactivated
3	green	Operating voltage GND
4	yellow	Operating voltage +24 V
5	grey	Digital input valve control +
6	pink	Digital input valve control -
7		Not assigned
8		Not assigned

Table 5: Pin assignment

\*) The indicated colors refer to the connecting cable available as an accessory with the order number 919267.

## 9.3 Connecting the device electrically, IO-Link, port class A

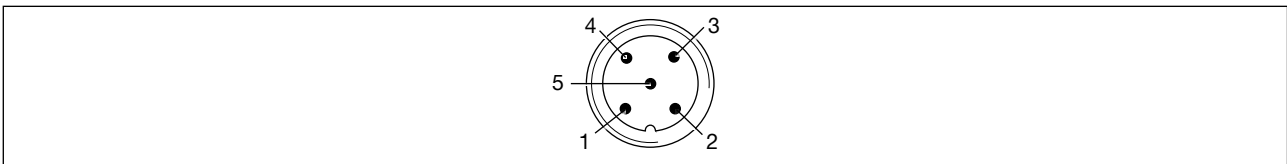

Figure 27: Pin assignment

Pin	Designation	Assignment	
1	L +	24 V DC	System supply
2	I/Q	N.C.	Not assigned
3	L -	0 V (GND)	System supply
4	C/Q	IO-Link	Communication
5	N.C.	N.C.	Not assigned

Table 6: Pin assignment

## 9.4 Connecting the device electrically, IO-Link, port class B

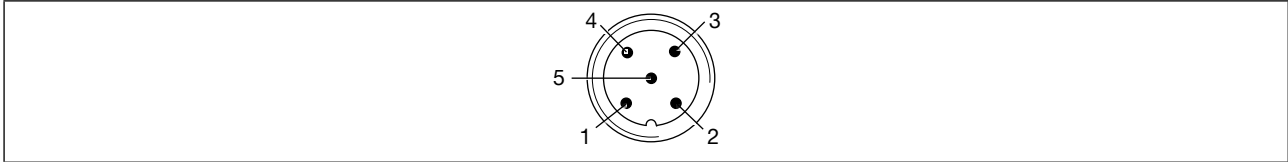

Figure 28: Pin assignment

Pin	Designation	Assignment	
1	L +	24 V DC	System supply
2	P24	24 V DC	Actuator supply
3	L –	0 V (GND)	System supply
4	C/Q	IO-Link	Communication
5	N24	0 V (GND)	Actuator supply

Table 7: Pin assignment

## 9.5 Connecting the device electrically, bÜS

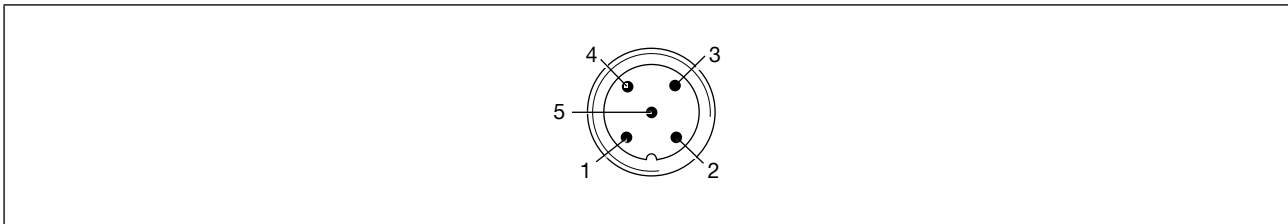

Figure 29: Pin assignment

Pin	Wire color*	Assignment
1	CAN plate/shielding	CAN plate/shielding**
2	red	+24 V DC $\pm$ 10%, max. residual ripple 10%
3	black	GND / CAN_GND
4	white	CAN_H
5	blue	CAN_L

Table 8: Pin assignment



**For electrical installation with bÜS network, note:**

Use a 5-pin round plug and shielded 5-core cable.

\* The indicated colours refer to the bÜS connection cables available as accessories.

\*\* Not connected to earth.

## 9.6 Connecting the device electrically, AS-Interface

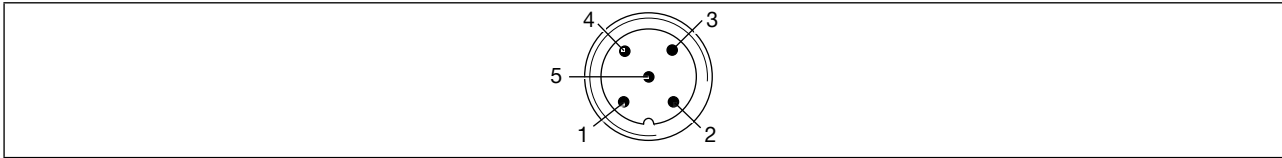

Figure 30: Pin assignment

Pin	Designation	Assignment
1	Bus +	Bus line AS-Interface +
2	AUX -	Actuator supply - (optional, only for variant with additional actuator supply (AUX Power))
3	Bus -	Bus line AS-Interface -
4	AUX +	Actuator supply + (optional, only for variant with additional actuator supply (AUX Power))
5	N.C.	Not assigned

Table 9: Pin assignment

## 9.7 Connecting the device electrically, AS-Interface with multi-pole cable and flat cable terminal

As an alternative to the bus connection variant with circular plug, the control head is available with a 1 metre long connection cable and M12 circular plug. The connection diagram of the circular plug corresponds to the bus connection M12 circular plug and can be easily connected with a flat cable terminal\*.

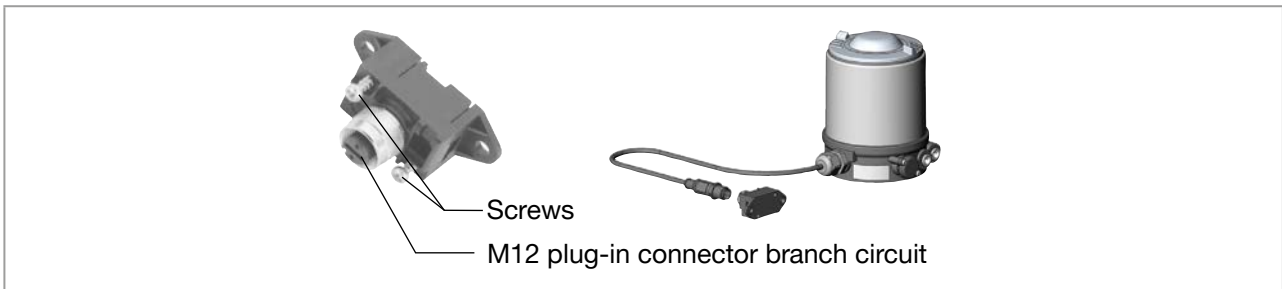

Figure 31: Control head 8691 with connection cable and flat cable terminal

### Handling the flat cable terminal

The flat cable terminal contacts the AS-Interface flat cable by means of penetration technology which allows installation by “clipping in” the AS-Interface flat cable without cutting and without removing insulation.

- Open the flat cable terminal (loosen screws and remove cover).
- Insert AS-Interface flat cable conclusively.
- Close flat cable terminal again.
- Tighten screws  
Slightly undo thread-forming screws (approx. 3/4 turn to the left) and position them on the existing tapped bore and screw in.

\* The flat cable clamp is available as an accessory under order number 799646.

# 10 START-UP

## 10.1 Invert process valve direction

In the factory settings, the following actuator end positions and colours of the status indicator are assigned to the valve positions:

Valve position	Status indicator	Actuator position
Valve closed	is lit green	Actuator deactivated
Valve open	is lit yellow	Actuator activated

Table 10: Factory settings

Depending on the device combination of actuator type and valve type, it follows whether the process valve direction must be inverted so that the valve position (closed/open) can be assigned to the actuator position:

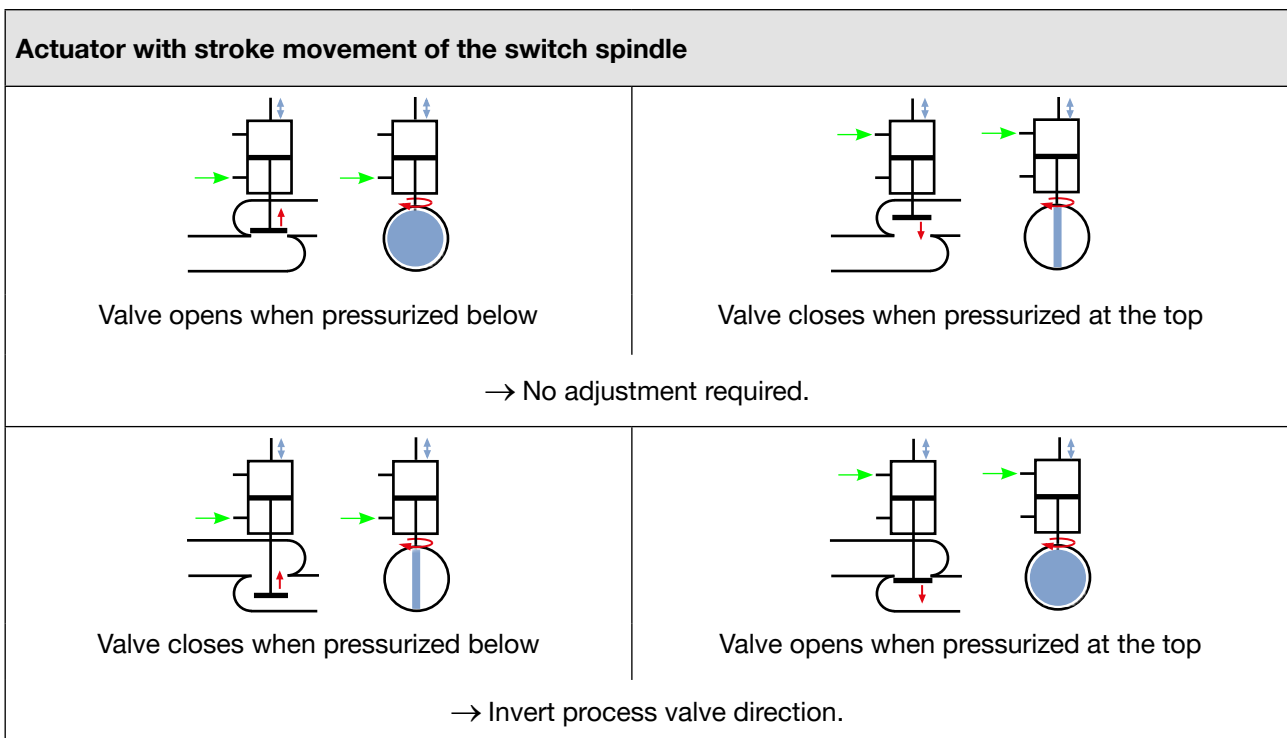

Table 11: Device combination

MAN 1000549653 EN Version: C Status: RL (released | freigegeben) printed: 06.05.2026

Actuator with rotational movement	
Rotational movement during aeration: clockwise (seen from above)	Rotational movement during aeration: anticlockwise (seen from above)
 <p>Valve opens when pressurized</p>	 <p>Valve closes when pressurized</p>
→ No adjustment required.	
 <p>Valve closes when pressurized</p>	 <p>Valve opens when pressurized</p>
→ Invert process valve direction.	

Table 12: Device combination

### Invert process valve direction:

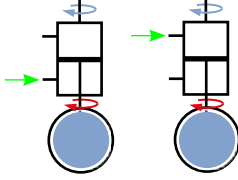
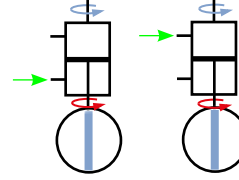
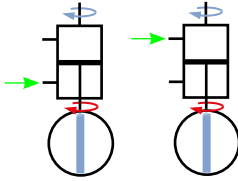
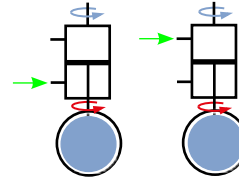
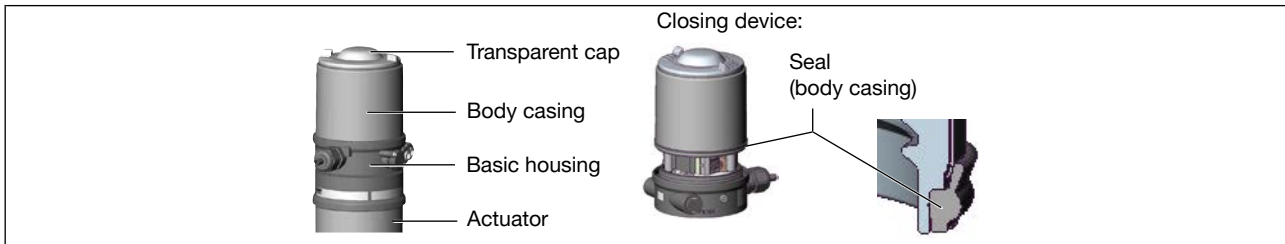

Figure 32: Opening or closing the device

### NOTE

#### Breakage of the pneumatic connection pieces due to rotational impact.

- ▶ When unscrewing and screwing in the body casing, do not hold the actuator of the process valve but the basic housing.

→ Unscrew the body casing (stainless steel) in an anticlockwise direction.

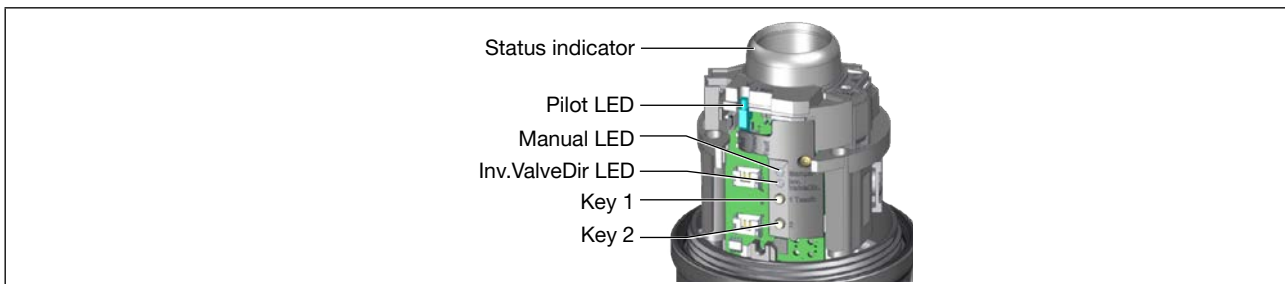

Figure 33: Operating and display elements

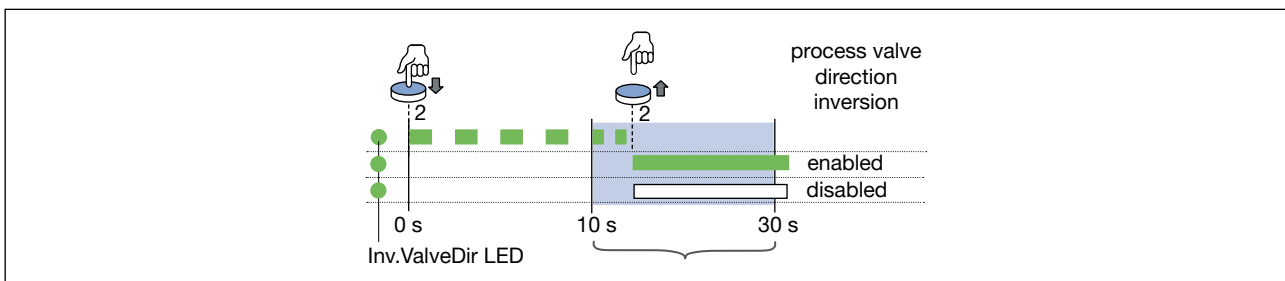

Figure 34: Invert process valve direction

→ Keep key 2 pressed for > 10 s. The green Inv.ValveDir LED flashes for 10 s at 5 Hz.

→ When the green Inv.ValveDir LED start flashing faster (10 Hz), release key 2 within the next 20 s.

✔ The valve direction inversion is enabled: the green Inv.ValveDir LED is lit.

✔ The valve direction inversion is disabled: the Inv.ValveDir LED is not lit.

→ Check that the seal (body casing) is in the correct position.

### NOTE

#### Damage or malfunction due to ingress of dirt or moisture.

To observe the degree of protection IP65 or IP67:

- ▶ Screw in body casing to the stop.

→ Close the device (see accessories for assembly tool).

## 10.2 Teach function: Determine end positions and save these, REV.3

- **Automatic teach function:** For devices with pilot valve  
The teach function automatically identifies and saves the end positions of the valve.
- **Manual teach function:** For devices without pilot valve  
The end positions are captured and saved automatically.
- **Teach-in-operation function:** is (if previously enabled) carried out automatically during the first switching in operation.

### 10.2.1 Start automatic teach function

For devices with pilot valve:

The teach function automatically identifies and saves the end positions of the valve.



With the IO-Link and AS-Interface variant, the teach function can also be started via the bus communication (see respective parameter list) or with all variants of the REV.3 versions with the Bürkert Communicator.

#### Essential requirements:

- The device is mounted on the actuator.
- The supply voltage is connected.
- The compressed air supply is connected.
- So that the correct reference conditions are identified, the pilot pressure must correspond to the operating conditions.

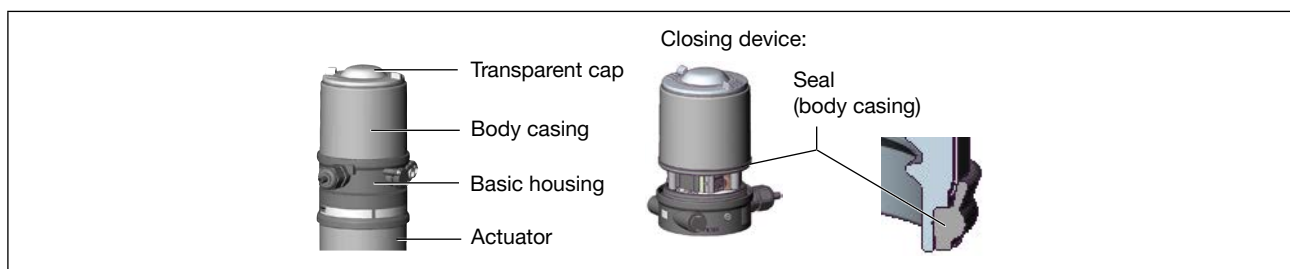

Figure 35: Opening or closing the device

#### NOTE

**Breakage of the pneumatic connection pieces due to rotational impact.**

- ▶ When opening or closing the device, do not press against the actuator, but against the basic housing.

→ Screw off the body casing by turning anticlockwise.

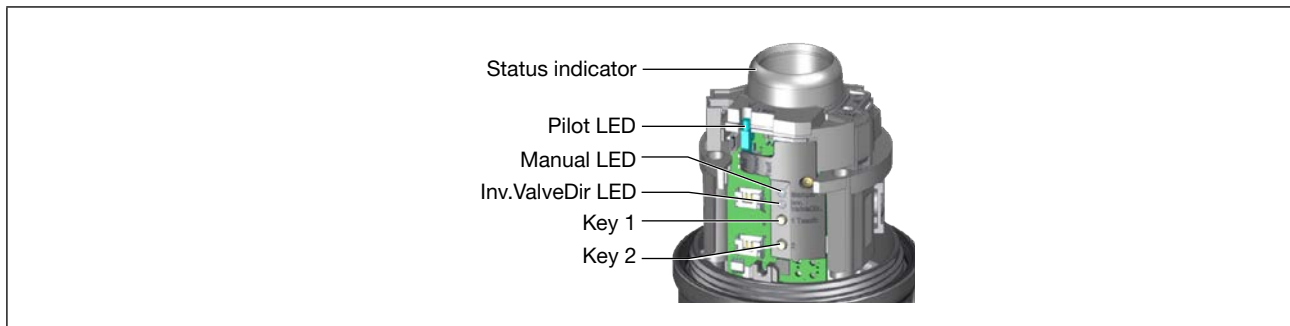

Figure 36: Operating and display elements

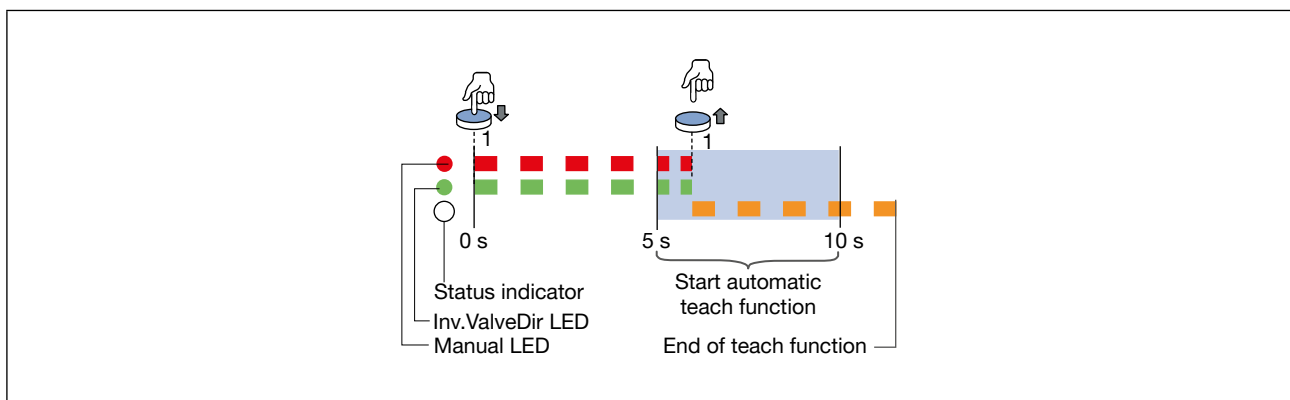

Figure 37: Start automatic teach function

→ Press and hold key 1 for > 5 s to start the automatic teach function. The red manual LED and the green Inv.ValveDir LED flash for 5 s at 5 Hz.

→ When the red manual LED and the green Inv.ValveDir LED start flashing faster (10 Hz), release key 1 within the next 5 s.

✓ The status indicator flashes orange while the automatic teach function is running (function check). When the status indicator stops flashing orange, the teach function is complete.

✓ The end positions of the valve have been identified and saved.

Note: If the status indicator is lit red, the teach function is faulty and must be repeated.

→ Check that the seal (body casing) is in the correct position.

## NOTE

**Damage or malfunction due to ingress of dirt or moisture.**

To observe the degree of protection IP65 or IP67:

▶ Screw in body casing to the stop.

→ Close the device (see accessories for assembly tool).

### Description of workflow for automatic teach function:

The status indicator blinks orange when the teach function is running.

- The end position is scanned in.
- The pilot valve switches.
- The actuator moves automatically to the upper position.
- The upper end position is scanned in.
- The pilot valve is switched off.
- The actuator moves to the lower position.

## 10.2.2 Start manual teach function

For devices without pilot valve:

The end positions are captured and saved manually by the user.

**!** With the IO-Link and AS-Interface variant, the teach function can also be started via the bus communication (see respective parameter list) or with all variants of the REV.3 versions with the Bürkert Communicator.

### Essential requirements:

- The device is mounted on the actuator.
- The supply voltage is connected.
- The compressed air supply is connected.
- So that the correct reference conditions are identified, the pilot pressure must correspond to the operating conditions.
- Provide the possibility for the user to switch the pneumatic actuator (open and closed).

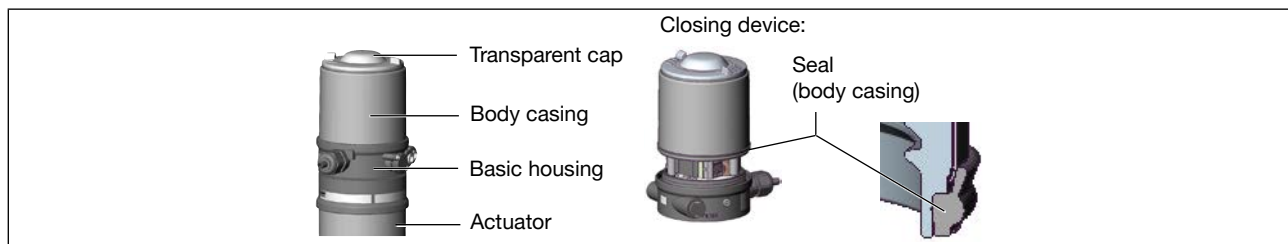

Figure 38: Opening or closing the device

### NOTE

**Breakage of the pneumatic connection pieces due to rotational impact.**

- ▶ When opening or closing the device, do not press against the actuator, but against the basic housing.

→ Screw off the body casing by turning anticlockwise.

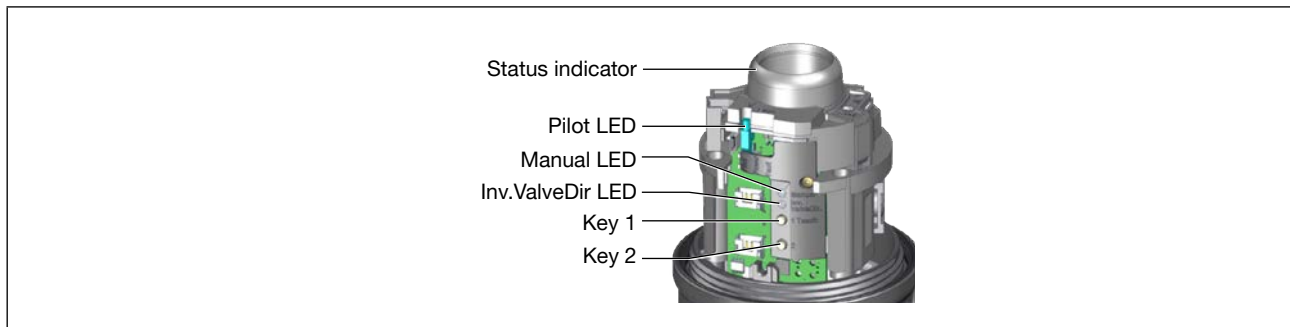

Figure 39: Operating and display elements

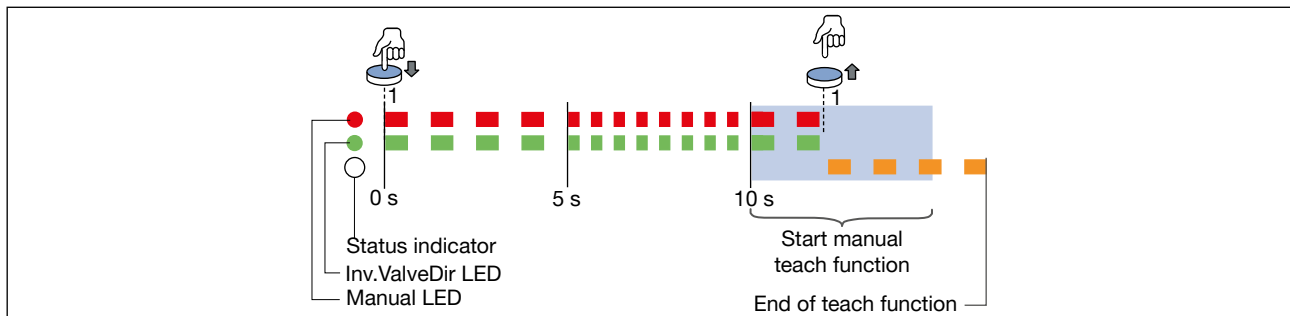

Figure 40: Start manual teach function

→ Air bleed the pneumatic actuator: move to the unactuated end position.

→ Press and hold key 1 to start the manual teach function for >10 s (red manual LED + green Inv.ValveDir LED flash together: the first 5 s slowly, the second 5 s quickly, >10 s slowly again, then release key 1).

✔ The status indicator flashes orange while the manual teach function is running (function check).

→ Check whether the pneumatic actuator is in the deaerated, unactuated end position.

→ Confirm this end position by briefly pressing key 1.

✔ Yellow Pilot LED is lit.

→ Move the pneumatic actuator into the aerated, switched end position.

→ Confirm this end position by briefly pressing key 1.

✔ Yellow Pilot LED is not lit.

→ Air bleed the pneumatic actuator: move to the unactuated end position.

✔ When the status indicator stops flashing orange, the teach function is complete.

✔ The end positions of the valve have been identified and saved.

Note: If the status indicator is lit red, the teach function is faulty and must be repeated.

→ Check that the seal (body casing) is in the correct position.

## NOTE

**Damage or malfunction due to ingress of dirt or moisture.**

To observe the degree of protection IP65 or IP67:

▶ Screw in body casing to the stop.

→ Close the device (see accessories for assembly tool).

### 10.2.3 Teach-in-operation function

The teach-in-operation function can be used if the device is to carry out the end positions of the process valve automatically during normal operation (once when the control unit is switched on for the first time).

This function may only be used for process valve actuators with control function A (normally closed).

The function must first be enabled via the büS service interface (Bürkert Communicator).

For devices that are delivered without a process valve, this function is already enabled because no other teach function has yet been carried out.

If the function is enabled, the device reports the device status „Warning“ (out of specification) until the first switching has been carried out properly, but it is ready for operation and outputs the end positions specified in the last properly carried out teach function via the digital outputs of the device.

#### Process description:

- Enable teach-in-operation function with the communicator.
- The device waits for the first switching of the pilot valve and outputs a „Warning“.
- If the pilot valve is switched for the first time, the first end position is determined.
- The process valve moves to the second end position.
- The process valve must remain in this second end position for at least 1 second, then this second end position is determined.
- Both end positions are saved and the „Warning“ device status is withdrawn.
- The enabling of this function is reset.

Note: the enabling of this function is also reset if one of the other two teach functions (automatic or manual teach function) was carried out before the first switching.

## 10.3 Setting with Bürkert Communicator

The Bürkert Communicator can be used to make all settings on the device.

### 10.3.1 Connecting the device with Bürkert Communicator

#### Devices without fieldbus communication, devices with IO-Link or AS-Interface via büS service interface:

Required components:

- Communications software: Bürkert Communicator for PC
- büS standard set (see accessories)
- büS adapter for büS service interface (see accessories)
- If necessary, a büS cable extension (see accessories)

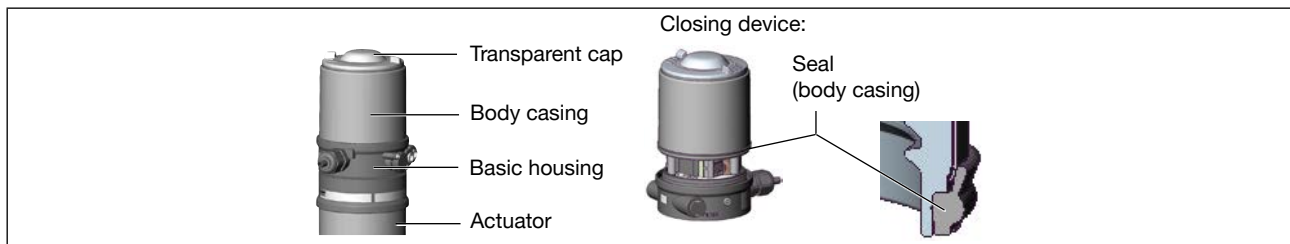

Figure 41: Opening or closing the device

## NOTE

**Breakage of the pneumatic connection pieces due to rotational impact.**

- ▶ When opening or closing the device, do not press against the actuator, but against the basic housing.

→ Screw off the body casing by turning anticlockwise.

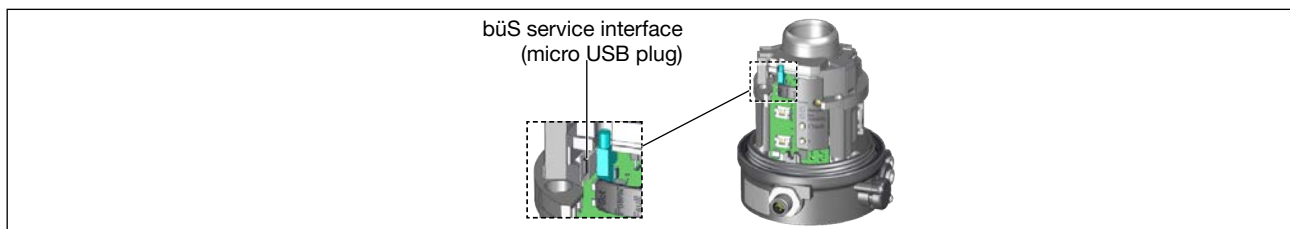

Figure 42: büS service interface

→ Insert micro USB plug in büS service interface.

→ Establish connection to PC with büS stick.

→ Starting Bürkert Communicator.

→ Implementing settings.

→ Check that the seal (body casing) is in the correct position.

## NOTE

**Damage or malfunction due to ingress of dirt or moisture.**

To observe the degree of protection IP65 or IP67:

- ▶ Screw in body casing to the stop.

→ Close the device (see accessories for assembly tool).

## Devices with büS:

Required components:

- Communications software: Bürkert Communicator for PC
- büS standard set (see accessories)

→ Establish connection to PC with büS stick.

→ Starting Bürkert Communicator.

→ Implementing settings.

## 10.4 IO-Link

### 10.4.1 Information, IO-Link

IO-Link is an internationally standardized IO technology (IEC 61131-9) to enable sensors and actuators to communicate.

IO-Link is a point-to-point communication with 3-wire connection technology for sensors and actuators and unshielded standard sensor cables.

### 10.4.2 Configuration of the fieldbus

The required start-up files and the description of the process data and acyclic parameters are available on the Internet.



Download from:

[www.burkert.com](http://www.burkert.com) / Type 8691 / Software

## 10.5 bÜS

### 10.5.1 Information, bÜS

bÜS is a system bus developed by Bürkert with a communication protocol based on CANopen.

### 10.5.2 Configuration of the fieldbus

The required start-up files and the description of objects are available on the Internet.



Download from:

[www.burkert.com](http://www.burkert.com) / Type 8691 / Software

## 10.6 AS-Interface

AS-Interface (Actuator Sensor Interface) is a field bus system which is used primarily for networking binary sensors and actuators (slaves) with a higher-level control (master). The unshielded two-wire line is used to transmit both the information (data) and the energy to supply the actuators and sensors.

### 10.6.1 Certification

The device is certified according to AS-Interface specification version 3.0.

Certificate No.: on request

### 10.6.2 Programming data

	AS-Interface 31 slaves	AS-Interface 62 slaves
I/O-Konfiguration	B hex (1 output, 2 inputs)	
ID code	F hex	A hex
Extended ID code 1	F hex	7 hex
Extended ID code 2	F hex	E hex
Profile	S-B.F.F	S-B.A.E

Table 13: Programming data

#### Bit configuration

Data bit	D3	D2	D1	D0
Input	0 0 End position not reached when actuator activated 1 End position reached when actuator activated	0 0 End position not reached when actuator deactivated 1 End position reached when actuator deactivated	–	–
Output	–	–	"1 → 0" (falling edge) START automatic teach function	0 Pilot valve OFF 1 Pilot valve ON
Parameter bit	P3	P2	P1	P0
Output	not used	not used	not used	"1 → 0" (falling edge) START automatic teach function

Table 14: Bit configuration

# 11 OPERATING AND DISPLAY ELEMENTS

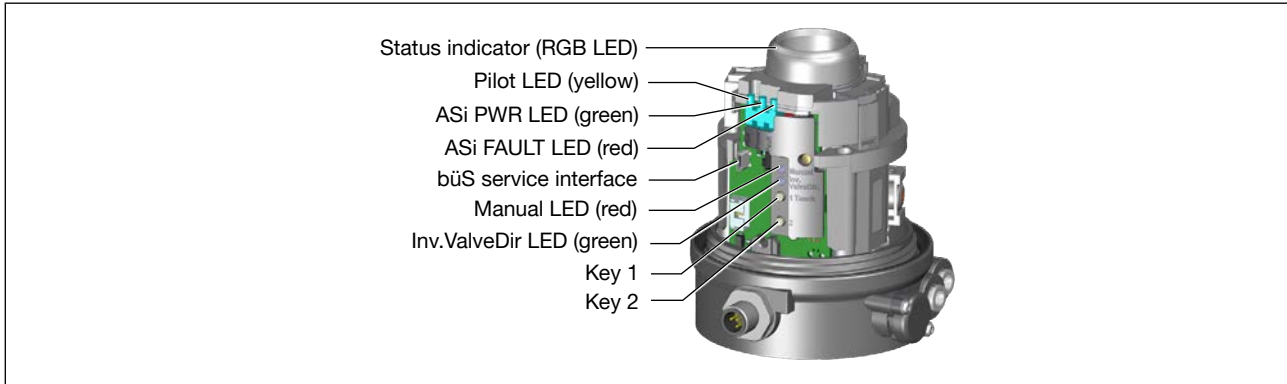

Figure 43: Operating and display elements

Key	Description of the functions*
1	Press and release within 5...10 s: start automatic teach function Press and release for >10 s: start manual teach function
2	Press briefly (only in MANUAL operating state): Switch pilot valve on/off  Press and release within 10...30 s: Enable/disable process valve direction inversion
1 and 2	Press both and release within 2...10 s: Switch MANUAL ↔ AUTO Press both and release within 10...30 s: Start device restart Press both and release for > 30 s: Reset device to factory settings

Table 15: Operating elements

\*The respective time window is indicated by the flashing frequency.

LED		Description of the displays
Status indicator RGB LED		Valve position, error, warning see chapter "Status indicator"
Pilot LED yellow		Is lit yellow: pilot valve is actuated (on)
Manual LED red		Is lit red: MANUAL operating state active
		Flashes red after pressing and holding keys 1 and 2: <ul style="list-style-type: none"> <li>• with 5 Hz for 0...2 s</li> <li>• with 10 Hz for 2...10 s</li> </ul> See key functions „Table 15“

LED		Description of the displays
Inv.ValveDir green		Is lit green: inversion of process valve direction active
		Flashes green after pressing and holding key 2: <ul style="list-style-type: none"> <li>• with 5 Hz for 0...10 s</li> <li>• with 10 Hz for 10...30 s</li> </ul> See key functions „Table 15“
Manual LED red and Inv.ValveDir LED green		Both flashes both after pressing and holding key 1: <ul style="list-style-type: none"> <li>• with 5 Hz for 0...5 s</li> <li>• with 10 Hz for 5...10 s</li> <li>• with 5 Hz &gt;10 s</li> </ul> See key functions „Table 15“
Pilot LED yellow and Manual LED red and Inv.ValveDir LED green		All flash after pressing and holding keys 1 and 2: <ul style="list-style-type: none"> <li>• with 5 Hz for 10...30 s</li> <li>• with 10 Hz &gt;30 s</li> </ul> See key functions „Table 15“
AS-Interface only:		
ASi PWR LED green		Display of ASi-Power
ASi FAULT LED red		Display of ASi-Fehler

Table 16: Display elements

AS-Interface only: Display of the bus status LED

ASi PWR-LED green	ASi FAULT-LED red	
Off	Off	POWER OFF
Is lit green	Is lit red	No data traffic (expired Watch Dog at slave address does not equal 0)
Is lit green	Off	OK
Flashing green	Is lit red	Slave address equals 0s
Is lit green	Flashing red	Sensor supply overloaded or external reset
Flashing green	Flashing red	Teach function error (periphery error*)

Table 17: Display of the bus status LED

\*The device is in error status.

Possible causes: Error in the teach function, alarm limits exceeded, internal device error.

For further details, connect the device to the Bürkert Communicator (see chapter „10.3“) or contact Bürkert Service.

## 11.1 Operating state



To operate the keys, make sure that the local control lock is deactivated/unlocked (factory setting): with communication software or fieldbus communication.

### AUTOMATIC (AUTO)

Normal controller mode is implemented and monitored in AUTOMATIC operating state.

### MANUAL (MANU)

In MANUAL operating state the valve can be opened and closed manually via the key 2.

## 11.2 Functions of the operating and display elements



To operate the keys, make sure that the local control lock is deactivated/unlocked (factory setting): with communication software or fieldbus communication.

### Open or close the device:

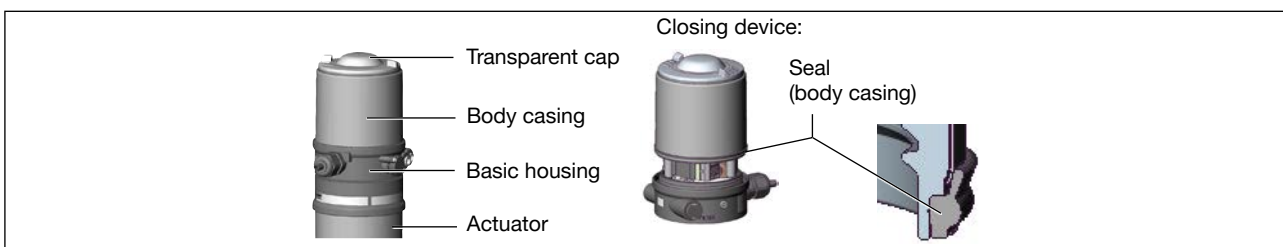

Figure 44: Opening or closing the device

Open the device:

#### NOTE

**Breakage of the pneumatic connection pieces due to rotational impact.**

- ▶ When unscrewing and screwing in the body casing, do not hold the actuator of the process valve but the basic housing.

→ Unscrew the body casing (stainless steel) in an anticlockwise direction.

Close the device:

→ Check that the seal (body casing) is in the correct position.

#### NOTE

**Damage or malfunction due to ingress of dirt or moisture.**

To observe the degree of protection IP65 or IP67:

- ▶ Screw in body casing to the stop.

→ Close the device (see accessories for assembly tool).

### Changing the operating state (MANU ↔ AUTO)

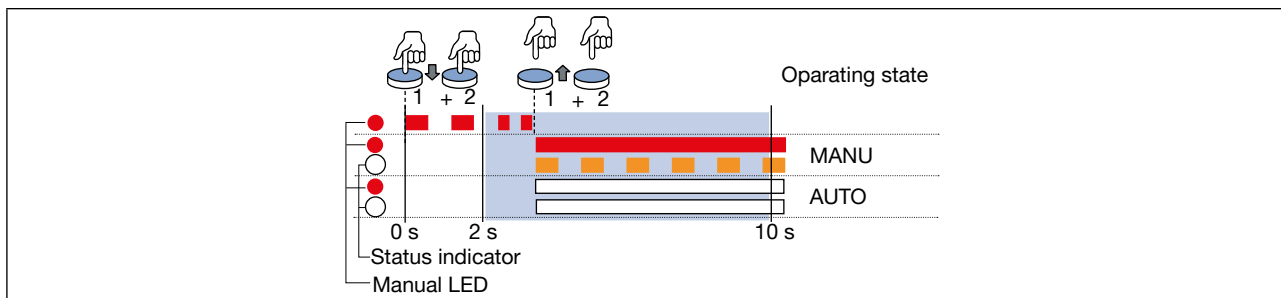

Figure 45: Changing the operating state

- Press and hold keys 1 and 2 for > 2 s. The red manual LED flashes for approx. 2 s at 5 Hz.
- When the red manual LED starts flashing faster (10 Hz), release keys 1 and 2 within the next 5 s.
- ✔ MANUAL operating state: the red manual LED is lit and the status indicator flashes orange.
- ✔ AUTO operating state: the red manual LED and the status indicator is not lit.

### Switch pilot valve (only possible in MANUAL operating state)

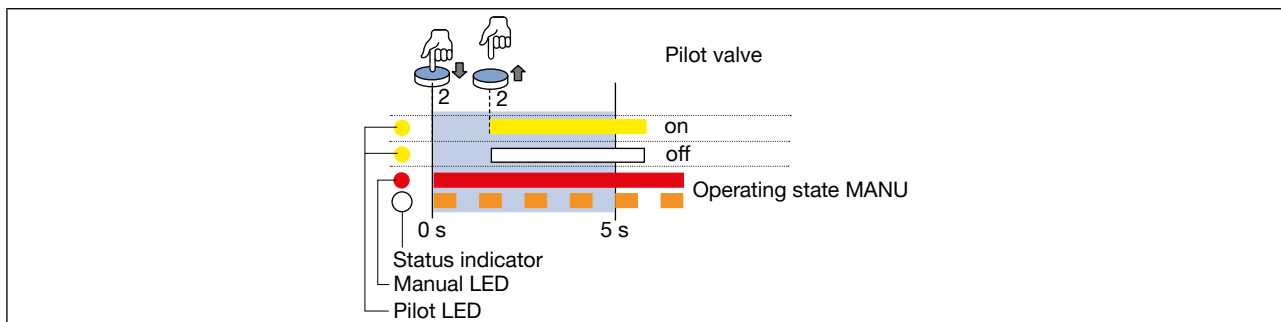

Figure 46: Switch pilot valve

- Briefly press key 2.
- ✔ Pilot valve on: the yellow pilot LED is lit.
- ✔ Pilot valve off: the yellow pilot LED is not lit.

### Perform device restart

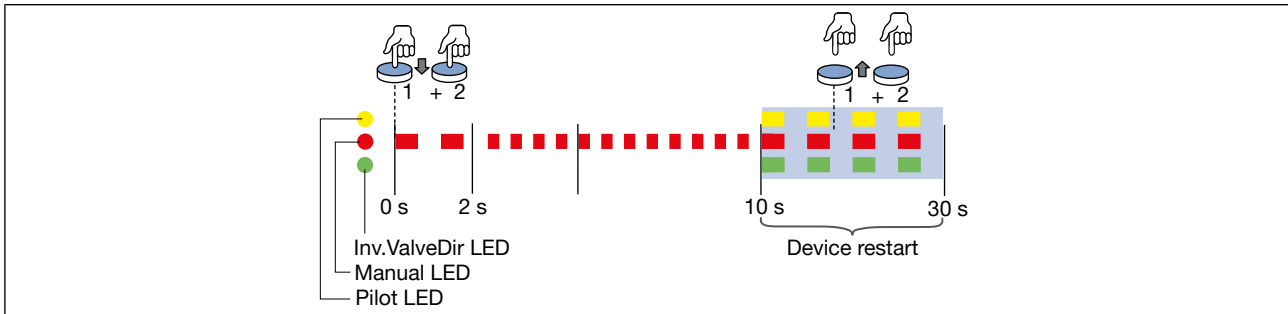

Figure 47: Perform device restart

→ Keep keys 1 and 2 pressed for 10–30 s. The red manual LED flashes for approx. 2 s at 5 Hz, then at 10 Hz.

→ When all 3 LEDs flashes more slowly (5 Hz), release keys 1 and 2 within the next 20 s.

✔ The device will restart.

### Factory reset

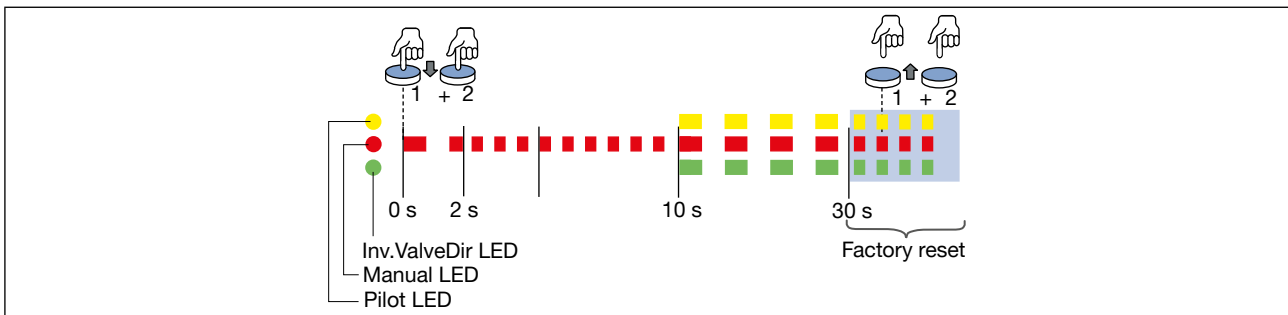

Figure 48: Factory reset

→ Keep keys 1 and 2 pressed for > 30 s. The red manual LED flashes for approx. 2 s at 5 Hz, then at 10 Hz, then all 3 LEDs flash at 5 Hz.

→ When all 3 LEDs are flashing faster (10 Hz), release keys 1 and 2.

✔ The device is reset to factory settings.

## 11.3 Status indicator

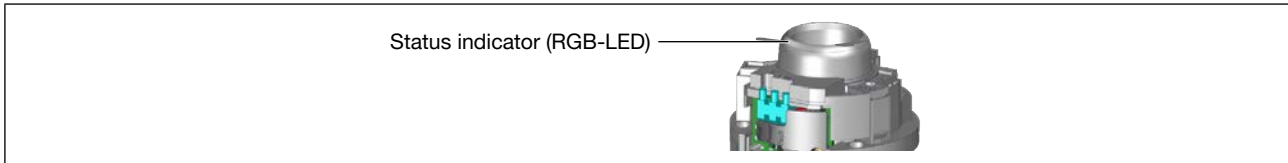

Figure 49: Status indicator

The status indicator (RGB LED) show the device status and the valve position.

The user can set the following LED modes:

- Valve mode
- Valve mode with error messages (valve mode + errors)
- Valve mode with error messages and warnings (valve mode + warnings, factory setting)
- NAMUR mode
- Fixed color
- LED off



With the IO-Link variant, the teach function can also be started via the bus communication (see respective parameter list) or with all variants of the REV.3 versions with the Bürkert Communicator.



The description for setting the LED mode can be found in the section "[11.5 Setting the LED mode, status indicator](#)" in the operating manual.



Restart the device after changing the LED mode.

## 11.4 Description of the LED modes

### 11.4.1 Valve mode

Displays in valve mode:

- Valve position: open, half-way, closed

Valve position	Valve position status, color
Open	is lit yellow*
Half-way	LED off*
Closed	is lit green*

Table 18: Valve mode

\* Factory setting, selectable colors for the valve position: Off, white, pink, blue, turquoise, green, yellow, orange, red

## 11.4.2 Valve mode with error messages (valve mode + errors)

Displays in valve mode with error messages (valve mode + errors):

- Valve position: open, half-way, closed
- Device status: Error

Valve position		Device status: Error	
	state, color	state, color	
Open	is lit yellow*	flashes red	alternately with yellow*
Half-way	LED off*	flashes red	alternately with LED off*
Closed	is lit green*	flashes red	alternately with green*

Table 19: Valve mode + errors, device status: Error

\* Factory setting, selectable colors for the valve position: Off, white, pink, blue, turquoise, green, yellow, orange, red

## 11.4.3 Valve mode with error messages and warnings (valve mode + warnings)

Displays in valve mode with error messages and warnings (valve mode + warnings):

- Valve position: open, half-way, closed
- Device status: error, function check, out of specification, maintenance required (according to NAMUR)

If several device statuses exist simultaneously, the device status with the highest priority is displayed.

Valve position		Device status: normal operation	
	state, color	state, color	
Open	is lit yellow*	--	
Half-way	LED off*	--	
Closed	is lit green*	--	

Table 20: Valve mode + warnings, normal operation

Valve position		Device status: Error	
	state, color	state, color	
Open	is lit yellow*	flashes red	alternately with yellow*
Half-way	LED off*	flashes red	alternately with LED off*
Closed	is lit green*	flashes red	alternately with green*

Table 21: Valve mode + warnings, device status: Error

Valve position		Device status: Function check	
	state, color	state, color	
Open	is lit yellow*	flashes orange	alternately with yellow*
Half-way	LED off*	flashes orange	alternately with LED off*
Closed	is lit green*	flashes orange	alternately with green*

Table 22: Valve mode + warnings, device status: Function check

Valve position		Device status: Out of specification	
	state, color	state, color	
Open	is lit yellow*	flashes yellow	alternately with yellow*
Half-way	LED off*	flashes yellow	alternately with LED off*
Closed	is lit green*	flashes yellow	alternately with green*

Table 23: Valve mode + warnings, device status: Out of specification

Valve position		Device status: Maintenance required	
	state, color	state, color	
Open	is lit yellow*	flashes blue	alternately with yellow*
Half-way	LED off*	flashes blue	alternately with LED off*
Closed	is lit green*	flashes blue	alternately with green*

Table 24: Valve mode + warnings, device status: Maintenance required

For error messages and warning messages, the LEDs are briefly switched off between the change of the colors.

For localizations, the colors are only shown momentarily.

If the colour of the valve position is identical to the device status, the LEDs go out briefly every second.

---

\* Factory setting, selectable colors for the valve position: Off, white, pink, blue, turquoise, green, yellow, orange, red

### 11.4.4 NAMUR mode

The display elements change color in accordance with NAMUR NE 107.

If several device statuses exist simultaneously, the device status with the highest priority is displayed. The priority is determined by the severity of the deviation from controlled operation (red LED = failure = highest priority).

Status display in accordance with NE 107, edition 2006-06-12			
Color	Color code	Status	Description
Red	5	Outage, error or malfunction	Normal operation is not possible due to a malfunction in the device or on its peripheral equipment.
Orange	4	Function check	Work is being carried out on the device; normal operation is therefore temporarily not possible
Yellow	3	Out of specification	Ambient conditions or process conditions for the device are outside the specified area.
Blue	2	Maintenance required	The device is in normal operation, although a function is briefly restricted. → Service device.
Green	1	Diagnostics active	Device is operating perfectly. Status changes are indicated in different colors. Messages are transmitted via a fieldbus if connected.

Table 25: Description of the colors

### 11.4.5 Fixed colour

Displays in fixed colour:

- Status indicator is lit white\*.

---

\* Factory setting, selectable colors for the valve position: Off, white, pink, blue, turquoise, green, yellow, orange, red

### 11.4.6 LED off

Displays in LED off:

- Status indicator is not lit.

## 11.5 Setting the LED mode, status indicator

User level: installer

Factory setting: valve mode + warnings

Menu or function		Values or description
Device		
	> General settings	
	> Parameter	
	> Status LED	
	Mode	<input type="radio"/> NAMUR mode <input type="radio"/> Valve mode <input type="radio"/> Valve mode + errors <input checked="" type="radio"/> Valve mode + warnings <input type="radio"/> Fixed color <input type="radio"/> LED off

### Setting the LED mode, status indicator:

→ Status LED

→ Mode

Possible selection:

- NAMUR mode
- Valve mode
- Valve mode + errors
- Valve mode + warnings
- Fixed color
- LED off

→ Select mode.

→ Restart the device after changing the LED mode.

✔ The mode is set.

## 11.6 Switching the device manually with pilot valve

The device can be switched manually with the pilot valve when the control air is connected.

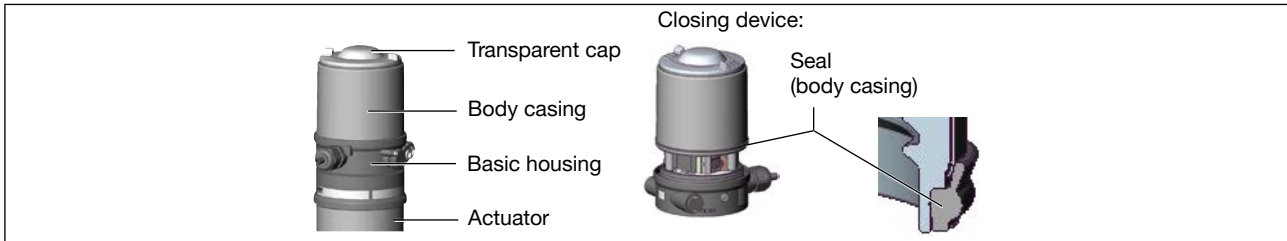

Figure 50: Opening or closing the device

### NOTE

**Breakage of the pneumatic connection pieces due to rotational impact.**

- ▶ When opening or closing the device, do not press against the actuator, but against the basic housing.

→ Screw off the body casing by turning anticlockwise.

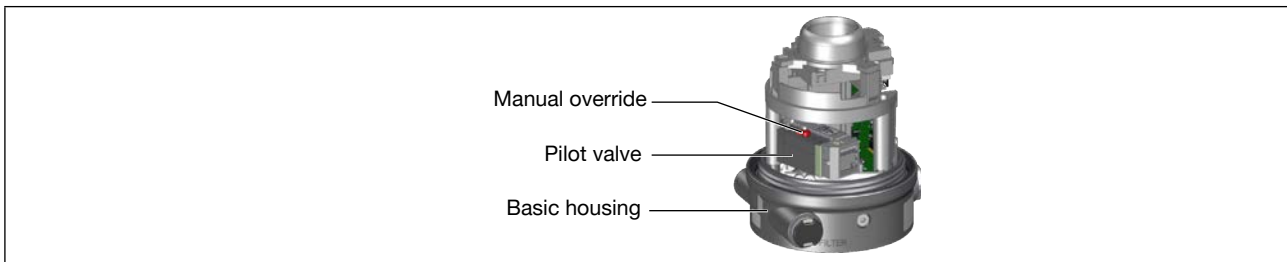

Figure 51: Manually switching the device

### NOTE

**Damage to the manual override by pressing and rotating at the same time.**

- ▶ Do not simultaneously press and turn manual override.

Switching the positions for manual override:

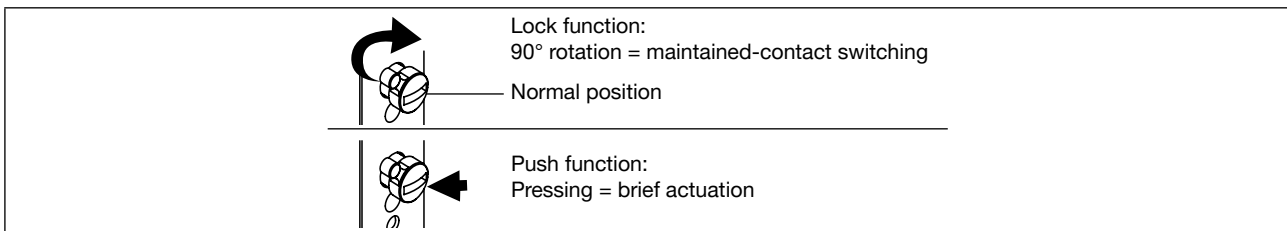

Figure 52: Manual override

→ Switch manual override with a screwdriver (button or click).

→ Check that seal is in the correct position.

### NOTE

**Damage or malfunction due to ingress of dirt or moisture.**

To observe the degree of protection IP65 or IP67:

- ▶ Screw in body casing to the stop.

→ Close the device (see accessories for assembly tool).

## 12 MAINTENANCE

### 12.1 Servicing the air intake filter

To protect the pilot valve and actuator, the pilot air is filtered.

Air flows through the air intake filter from inside to outside through the filter fabric in its pre-installed state.

#### **DANGER!**

Risk of injury if not maintained correctly.

- ▶ Only trained and qualified personnel may perform maintenance.
- ▶ Perform maintenance with suitable tools only.

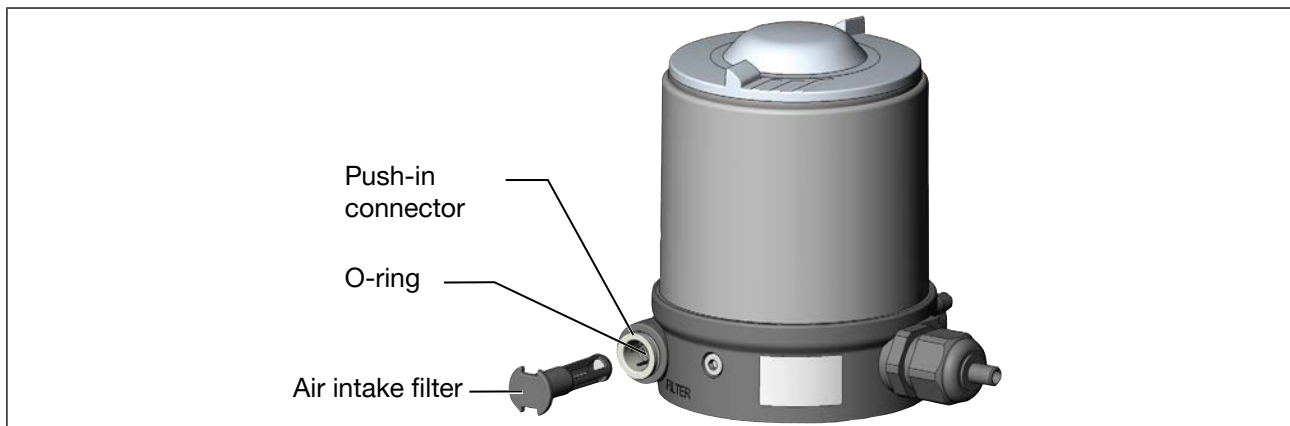

Figure 53: Servicing the air intake filter

#### **DANGER!**

Risk of injury from high pressure and discharge of medium.

- ▶ Before working on the device or system, switch off the pressure. Vent or drain lines.

- Unclamp the push-in connector by pressing the collet, then pull out the air intake filter. If necessary, use a suitable tool between the recesses in the head of the air intake filter.
- Clear or (if appropriate) replace the filter.
- Check the inside O-ring and clean if necessary.
- Push the air intake filter into the push-in connector as far as it will go.
- Ensure that the air intake filter is securely seated.

## 13 DEINSTALLATION

### 13.1 Safety instructions deinstallation

 **DANGER**

Risk of injury from high pressure and discharge of medium.

- ▶ Before working on the device or system, switch off the pressure. Vent or drain lines.

 **DANGER**

Risk of injury from electric shock.

- ▶ Before working on the device or system, switch off the power supply. Secure against reactivation.
- ▶ Observe applicable accident prevention and safety regulations for electrical equipment.

 **WARNING**

Risk of injury due to improper deinstallation.

- ▶ Only trained technicians may perform deinstallations.
- ▶ Perform deinstallations with suitable tools only.

 **WARNING**

Risk of injury due to unintentional activation and uncontrolled start-up of the system.

- ▶ Secure system against unintentional activation.
- ▶ Ensure that the system does not start up in an uncontrolled manner.

## 13.2 Deinstallation

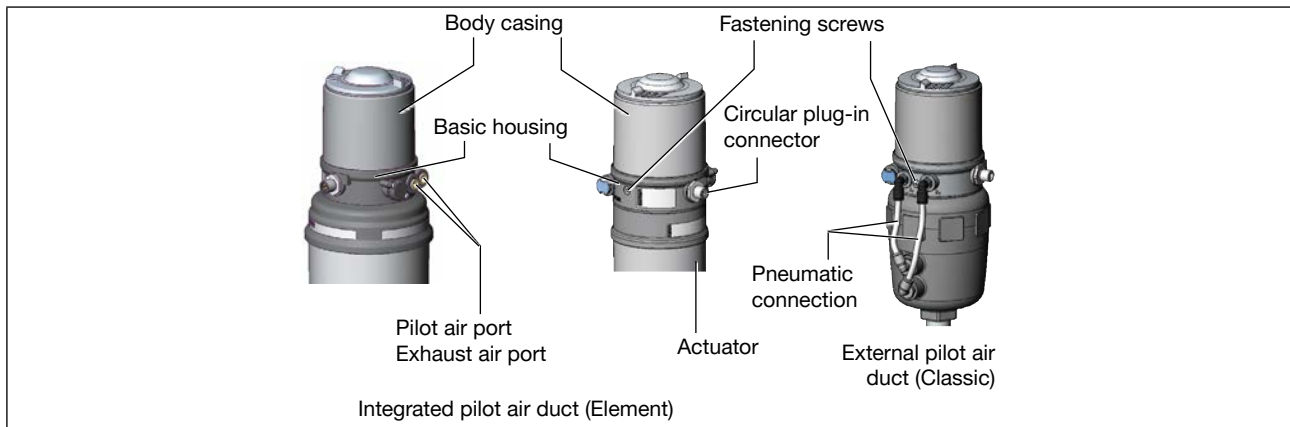

Figure 54: Deinstalling the device

### Pneumatically deinstalling the device

- Disconnect pilot air port.
- When exhaust air port connected: Disconnect exhaust air port:
- With external control air duct (Classic):  
Disconnect the pneumatic connection to the actuator.

### Electrically deinstalling the device

Devices with circular plug-in connector:

- Disconnect the circular plug.

### Mechanically deinstalling the device

- Release the fastening screws.
- Pull off the device by lifting upward.

## 14 SPARE PARTS, ACCESSORIES

Designation	Order no.
Special wrench	665702
Wrench for opening/closing the transparent cap	674077
Communication software Bürkert Communicator	Information at <a href="http://www.burkert.com">www.burkert.com</a>

USB-büS interface set:	
büS interface set 2 (büS stick + 0.7 m cable with M12 plug)	772551
büS adapter for büS service interface (M12 on büS service interface Micro-USB)	773254
büS cable extension (M12 pin to M12 socket), length 1 m	772404
büS cable extension (M12 pin to M12 socket), length 3 m	772405
büS cable extension (M12 pin to M12 socket), length 5 m	772406
büS cable extension (M12 pin to M12 socket), length 10 m	772407
Connection cable PUR with socket M12 x 1, 8-pin, length 2 m	919061

Table 26: Accessories

### 14.1 Communications software

The Bürkert Communicator PC program is designed for communication with Type 8691 devices.

For questions regarding compatibility, please contact the Bürkert Sales Center.



A detailed description for installing and operating the software can be found in the associated operating instructions.

Download the software from: [www.burkert.com](http://www.burkert.com)

## 15 TRANSPORTATION, STORAGE

### NOTE

Damage in transit due to inadequately protected devices.

- ▶ Protect the device against moisture and dirt in shock-resistant packaging during transportation.
- ▶ Observe permitted storage temperature.

### NOTE

Incorrect storage may damage the device.

- ▶ Store the device in a dry and dust-free location.
- ▶ Storage temperature: -20 to +65 °C

## 16 DISPOSAL



- ▶ Follow national regulations regarding disposal and the environment.
- ▶ Collect electrical and electronic devices separately and dispose of them as special waste.

Further information [country.burkert.com](https://country.burkert.com)





