

NUMATICS®

LCX Series

Linear Slide



www.numatics.com

LCX Series

Features and Benefits	3
How To Order	4
Dimensions	5
Technical Specifications	5
Sensing Part Numbers	6-8
Quick Disconnect Cables	9

LCX Series

The LCX combines cost-effectiveness with proven dependability. An economical alternative with greater load carrying capabilities.

- Low Cost
- High Load Capability
- Stainless Steel Shafts Available
- Engineered Plastic Polymer Bearing
- Available in 3 Bore Sizes

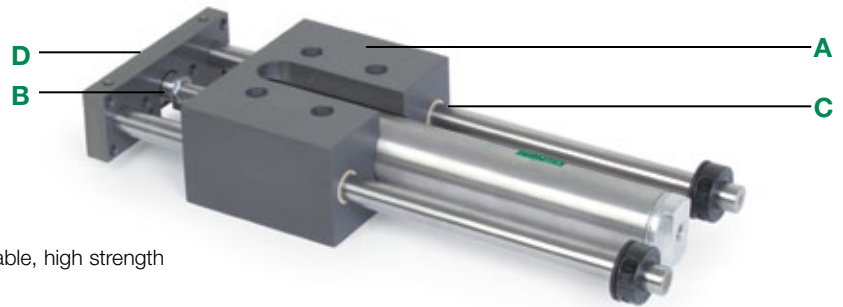

A. Body:

Hardcoat anodized aluminum.....Lightweight, durable, high strength
Increased load carrying capability

B. Alignment Coupler:

360 Degrees of float.....Isolates air cylinder from destructive side loads maximum
cylinder life

C. Bushings:

Engineered plastic polymer.....Low friction, high durability, no lubrication required
Maximum rigidity.....Superior rod diameter to bushing length ratio

D. NuMate™ Mounting:

Direct mount mounting system....Mount other Numatics products directly to
tooling plate

How to Order

LCX 075 04 H 1 6 D XX

Bore Sizes

- 075 = 3/4" Inch
- 106 = 1-1/16" Inches
- 150 = 1-1/2" Inches

Standard Stroke

- X5 = 1/2" 08 = 8"
- 01 = 1" 09 = 9"
- X9 = 1-1/2" 10 = 10"
- 02 = 2" 11 = 11"
- 03 = 3" 12 = 12"
- 04 = 4" 13 = 13"
- 05 = 5" 14 = 14"
- 06 = 6" 15 = 15"
- 07 = 7"

Guide Shaft Type

- H = Hardened Steel
- S = Stainless Steel

Cylinder Type

- 1 = Buna-N Seals
- 2 = FKM Seals / No Magnet
- 3* = Buna-N Seals w/Cushions
- 4 = FKM Seals / with Magnet

*Cushions available on bore sizes 106 and 150
 • Max temperature for LCX Series is 140°F.

Options

- XX = No Options
 - SE* = Stop Collars for Extend Stroke Adjust
 - SR* = Stop Collars for Retract Stroke Adjust
 - SB = Stop Collars for Extend and Retract
- *Stop collars will be stainless when guide shafts are stainless

Sensing Position

- A = Single Position Extend
- B = Single Position Retract
- C = Two Position Sensing
- D = No Sensing

Sensing Type

- Standard Cord Set
- 1 = Hall Effect - PNP (sourcing)
 - 2 = Hall Effect - NPN (sinking)
 - 3 = Reed Switch
 - 4 = Prox Switch on Cylinder - PNP (sourcing)
 - 5 = Prox Switch on Cylinder - NPN (sinking)
 - 6 = No Sensing
- Quick Disconnect Cord Set
- Z = Hall Effect - PNP (sourcing)
 - Y = Hall Effect - NPN (sinking)
 - X = Reed Switch
 - W = Prox Switch on Cylinder - PNP (sourcing) Straight
 - V = Prox Switch on Cylinder - NPN (sinking) Straight
 - U = Prox Switch on Cylinder - PNP (sourcing) 90 Deg.
 - T = Prox Switch on Cylinder - NPN (sinking) 90 Deg.

When ordering additional accessories:

Switch Description	Standard Part No.	Quick Disconnect Part No.
Hall Effect - PNP (Sourcing)	PNP-FL2-00-U	PNP-QDS-M8-U
Hall Effect - NPN (Sinking)	NPN-FL2-00-U	NPN-QDS-M8-U
Reed Switch	REED-FL2-00	REED-QDS-M8U
90° 5 meter cable	-	PXC90
Straight 5 meter cable	-	PXCST

*Bands and tracks required for mounting.
 Reference bracket in the Switch Application Chart in the Sensor section.

LCX Series Dimensions and Specifications

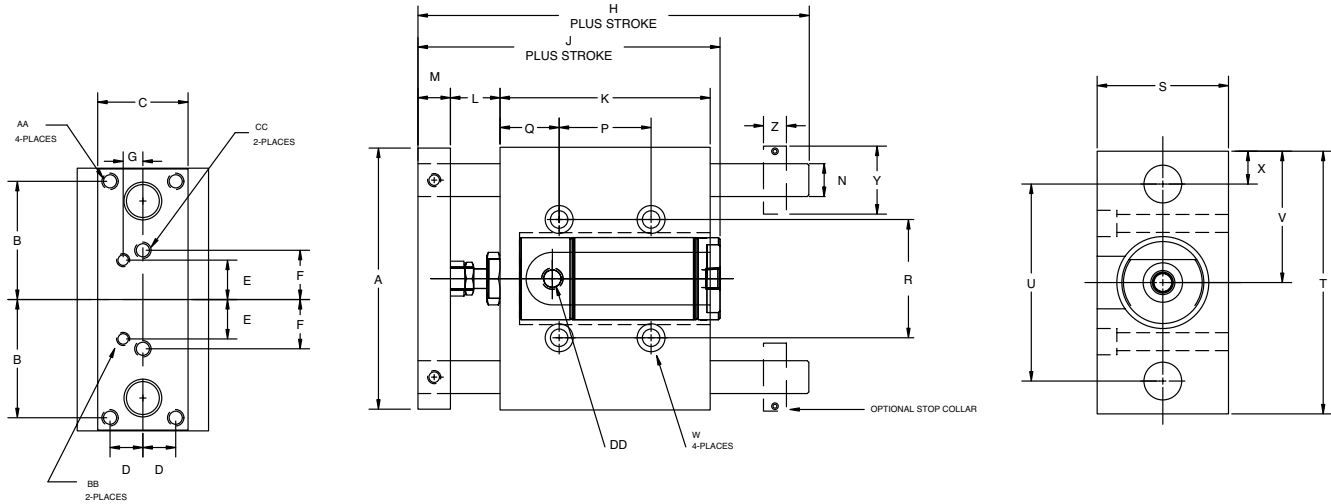

Bore	A	B	C	D	E	F	G	H	J	K	L	M	N	P
0.750	3.36	1.50	0.94	0.31	0.50	0.62	0.18	4.06	3.75	2.28	0.62	0.47	0.37	0.94
1.062	3.90	1.75	1.40	0.50	0.62	0.75	0.23	4.66	4.24	2.57	0.82	0.48	0.50	1.37
1.500	4.97	2.25	1.72	0.62	0.75	0.93	0.37	6.43	4.75	4.00	0.94	0.61	0.62	1.75

Bore	Q	R	S	T	U	V	W	X	Y	Z	AA	BB	CC	DD
0.750	0.51	1.50	1.25	3.40	2.50	1.70	C'bored for 1/4 SHCS	0.45	0.87	0.35	10-32 thru	6-32 thru	10-32 thru	1/8 NPTF
1.062	0.38	1.87	2.00	3.95	3.00	1.97	C'bored for 5/16 SHCS	0.47	1.12	0.41	1/4-20 thru	10-32 thru	1/4-20 thru	1/8 NPTF
1.500	1.12	2.25	2.50	5.00	3.75	2.50	C'bored for 5/16 SHCS	0.62	1.29	0.43	5/16-18 thru	1/4-20 thru	5/16-18 thru	1/8 NPTF

Maximum Side Loads (lbs) Maximum Moment (in-lbs)

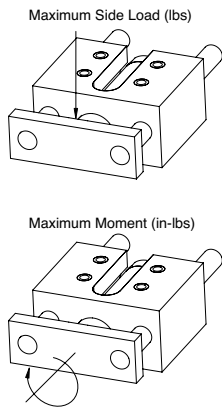

Stroke	LCX 075	LCX 106	LCX150	LCX 075	LCX 106	LCX 150
1	102	165	273	108	259	546
2	82	136	233	87	212	466
3	66	116	199	70	181	398
4	55	98	170	58	153	340
5	45	86	144	48	134	288
6	39	74	124	41	116	248
7	34	65	109	36	101	218
8	30	57	97	32	89	194
9	26	52	87	28	81	174
10	24	47	79	26	73	158
11	22	43	72	23	67	144
12	20	39	66	21	61	132
13	19	36	62	20	57	124
14	17	34	58	19	53	117
15	16	32	55	17	50	110

Unit Output Force

	LCX 075	LCX 106	LCX150
Extend Force (lbs)	0.44	0.88	1.76
Retract Force (lbs)	0.39	0.81	1.61

Multiply force factor X input pressure in psi
 Example: LCX075 extend force @ 70psi .44 X 70= 30.8

Static Rating

Sensing Part Numbers

PNP-FL2-00-U

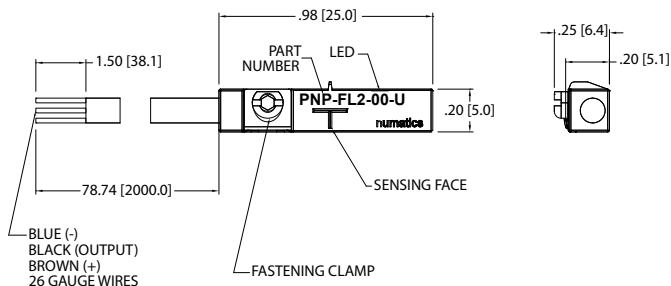

PNP-QDS-M8-U

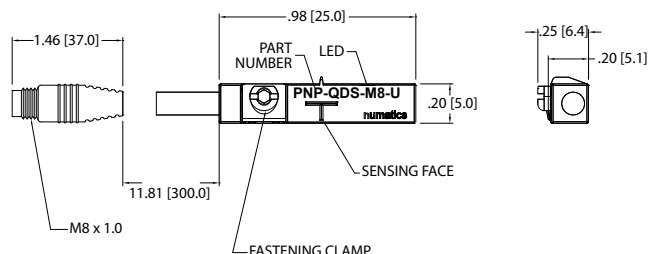





ELECTRICAL DESIGN	DC PNP
OUTPUT	Normally Open
OPERATING VOLTAGE	10-30 VDC
CURRENT RATING	100 mA
SHORT-CIRCUIT PROTECTION	Yes
OVERLOAD PROTECTION	Yes
REVERSE POLARITY PROTECTION	Yes
VOLTAGE DROP	< 2.5 V
CURRENT CONSUMPTION	< 12 mA
REPEATABILITY	< .2mm
POWER-ON DELAY TIME	< 30 ms
SWITCH FREQUENCY	> 3000 Hz
AMBIENT TEMPERATURE	-25°C to 85°C
PROTECTION	IP 67, III
HYSTERESIS	1.0mm
MAGNETIC SENSITIVITY	2.0 mT
TRAVEL SPEED	> 10 m/s
HOUSING MATERIAL	PA (Polyamide) Black; Fastening Clamp: Stainless Steel
FUNCTION DISPLAY SWITCHING STATUS	Yellow LED
CONNECTION	Flying Leads, Pur Cable (2m Long, 3 x26 Gauge Wire)
REMARKS	Clamping Screw with Combined Slot/Hexagon Socket Head AF 1.5 cULus - Class 2 Source Required
ACCESSORIES	Rubber Placeholder, Cable Clip, and Cut Sheet To Be Provided with Every Switch
AGENCY APPROVALS	CE cUL us RoHS

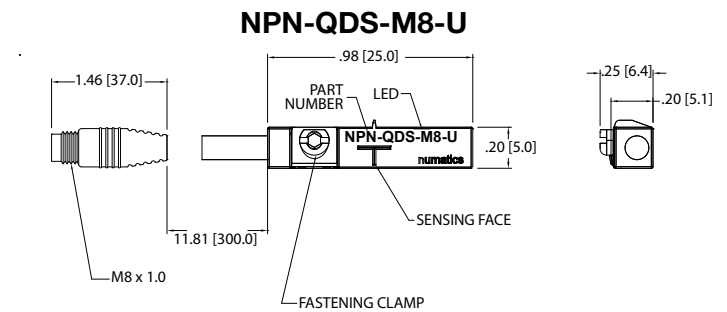
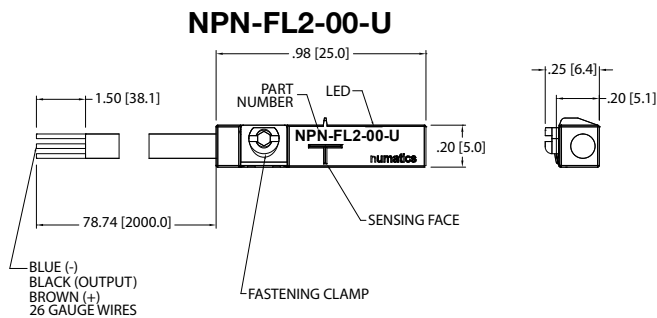

ELECTRICAL DESIGN	DC PNP
OUTPUT	Normally Open
OPERATING VOLTAGE	10-30 VDC
CURRENT RATING	100 mA
SHORT-CIRCUIT PROTECTION	Yes
OVERLOAD PROTECTION	Yes
REVERSE POLARITY PROTECTION	Yes
VOLTAGE DROP	< 2.5 V
CURRENT CONSUMPTION	< 12 mA
REPEATABILITY	< .2mm
POWER-ON DELAY TIME	< 30 ms
SWITCH FREQUENCY	> 3000 Hz
AMBIENT TEMPERATURE	-25°C to 85°C
PROTECTION	IP 67, III
HYSTERESIS	1.0mm
MAGNETIC SENSITIVITY	2.0 mT
TRAVEL SPEED	> 10 m/s
HOUSING MATERIAL	PA (Polyamide) Black; Fastening Clamp: Stainless Steel
FUNCTION DISPLAY SWITCHING STATUS	Yellow LED
CONNECTION	M8 Connector (Snap Fit) , Pur Cable (.3 m)
REMARKS	Clamping Screw with Combined Slot/Hexagon Socket Head AF 1.5 cULus - Class 2 Source Required
ACCESSORIES	Rubber Placeholder, Cable Clip, and Cut Sheet To Be Provided with Every Switch
AGENCY APPROVALS	CE cUL us RoHS

*Switches are not designed for wet environments. Please see your distributor for additional information.

Sensing Part Numbers



ELECTRICAL DESIGN	DC NPN
OUTPUT	Normally Open
OPERATING VOLTAGE	10-30 VDC
CURRENT RATING	100 mA
SHORT-CIRCUIT PROTECTION	Yes
OVERLOAD PROTECTION	Yes
REVERSE POLARITY PROTECTION	Yes
VOLTAGE DROP	< 2.5 V
CURRENT CONSUMPTION	< 12 mA
REPEATABILITY	< .2mm
POWER-ON DELAY TIME	< 30 ms
SWITCH FREQUENCY	> 3000 Hz
AMBIENT TEMPERATURE	-25°C to 85°C
PROTECTION	IP 67, III
HYSTERESIS	1.0mm
MAGNETIC SENSITIVITY	2.0 mT
TRAVEL SPEED	> 10 m/s
HOUSING MATERIAL	PA (Polyamide) Black; Fastening Clamp: Stainless Steel
FUNCTION DISPLAY SWITCHING STATUS	Yellow LED
CONNECTION	Flying Leads, Pur Cable (2m Long, 3 x26 Gauge Wire)
REMARKS	Clamping Screw with Combined Slot/Hexagon Socket Head AF 1.5 cULus - Class 2 Source Required
ACCESSORIES	Rubber Placeholder, Cable Clip, and Cut Sheet To Be Provided with Every Switch
AGENCY APPROVALS	  

ELECTRICAL DESIGN	DC NPN
OUTPUT	Normally Open
OPERATING VOLTAGE	10-30 VDC
CURRENT RATING	100 mA
SHORT-CIRCUIT PROTECTION	Yes
OVERLOAD PROTECTION	Yes
REVERSE POLARITY PROTECTION	Yes
VOLTAGE DROP	< 2.5 V
CURRENT CONSUMPTION	< 12 mA
REPEATABILITY	< .2mm
POWER-ON DELAY TIME	< 30 ms
SWITCH FREQUENCY	> 3000 Hz
AMBIENT TEMPERATURE	-25°C to 85°C
PROTECTION	IP 67, III
HYSTERESIS	1.0mm
MAGNETIC SENSITIVITY	2.0 mT
TRAVEL SPEED	> 10 m/s
HOUSING MATERIAL	PA (Polyamide) Black; Fastening Clamp: Stainless Steel
FUNCTION DISPLAY SWITCHING STATUS	Yellow LED
CONNECTION	M8 Connector (Snap Fit) , Pur Cable (.3 m)
REMARKS	Clamping Screw with Combined Slot/Hexagon Socket Head AF 1.5 cULus - Class 2 Source Required
ACCESSORIES	Rubber Placeholder, Cable Clip, and Cut Sheet To Be Provided with Every Switch
AGENCY APPROVALS	  

*Switches are not designed for wet environments. Please see your distributor for additional information.

Sensing Part Numbers

REED-FL2-00

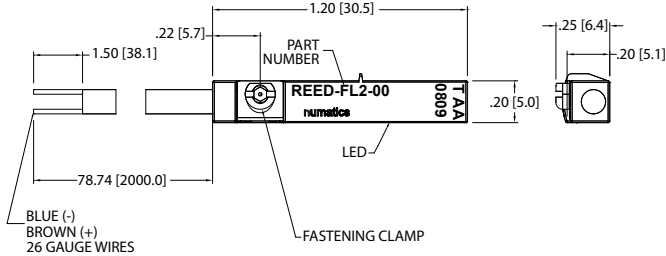

REED-QDS-M8U

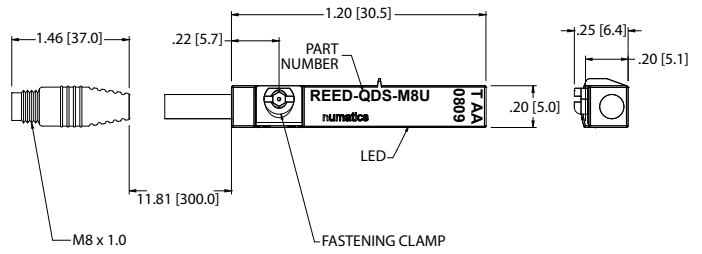

ELECTRICAL DESIGN	AC/DC REED
OUTPUT	Normally Open
OPERATING VOLTAGE	5-120 VAC/DC
CURRENT RATING	100 mA*
SHORT-CIRCUIT PROTECTION	No
OVERLOAD PROTECTION	No
REVERSE POLARITY PROTECTION	Yes
VOLTAGE DROP	< 5 V
REPEATABILITY	± .2mm
MAKETIME INCLUDING BOUNCE	< .6 ms
BREAKTIME	< .1 ms
SWITCHING POWER (MAX)	5 W
SWITCH FREQUENCY	1000 Hz
AMBIENT TEMPERATURE	-25°C to 70°C
PROTECTION	IP 67, II
HYSTERESIS	.9mm
HOUSING MATERIAL	PA (Polyamide) Black; Fastening Clamp: Stainless Steel
FUNCTION DISPLAY SWITCHING STATUS	Yellow LED
CONNECTION	Flying Leads, Pur Cable (2m Long, 2 x26 Gauge Wire)
REMARKS	*External Protective Circuit for Inductive Load (Valve, Contactor, Etc..) Necessary. Conforms to 2008 NEC Section 725 III, Class 2 Circuits Clamping Screw with Combined Slot/Hexagon Socket Head AF 1.5. No LED Function in case of Polarity in DC Operation
ACCESSORIES	Rubber Placeholder, Cable Clip, and Cut Sheet To Be Provided with Every Switch
AGENCY APPROVALS	CE RoHS

ELECTRICAL DESIGN	AC/DC REED
OUTPUT	Normally Open
OPERATING VOLTAGE	*5-60 VDC / 5-50 VAC
CURRENT RATING	100 mA
SHORT-CIRCUIT PROTECTION	No
OVERLOAD PROTECTION	No
REVERSE POLARITY PROTECTION	Yes
VOLTAGE DROP	< 5 V
REPEATABILITY	± .2mm
MAKETIME INCLUDING BOUNCE	< .6 ms
BREAKTIME	< .1 ms
SWITCHING POWER (MAX)	5 W
SWITCH FREQUENCY	1000 Hz
AMBIENT TEMPERATURE	-25°C to 70°C
PROTECTION	IP 67, II
HYSTERESIS	.9mm
HOUSING MATERIAL	PA (Polyamide) Black; Fastening Clamp: Stainless Steel
FUNCTION DISPLAY SWITCHING STATUS	Yellow LED
CONNECTION	M8 Connector (Snap Fit), Pur Cable (.3m)
REMARKS	*External Protective Circuit for Inductive Load (Valve, Contactor, Etc..) Necessary. Conforms to 2008 NEC Section 725 III, Class 2 Circuits M8 Connector voltage limited to 5-60 vdc / 5-50 vac to conform with 2008 IEC 61076-2-104 Clamping Screw with Combined Slot/Hexagon Socket Head AF 1.5. No LED Function in case of Polarity in DC Operation
ACCESSORIES	Rubber Placeholder, Cable Clip, and Cut Sheet To Be Provided with Every Switch
AGENCY APPROVALS	CE RoHS

*Switches are not designed for wet environments. Please see your distributor for additional information.

Quick Disconnect Cables

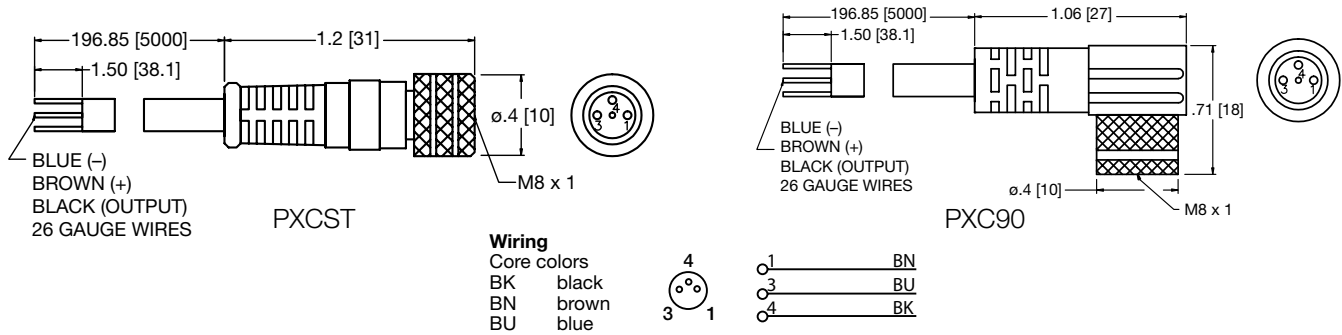

Order Code	Type	Operating Voltage	Current Rating	Cable Material	Protection	Connector
PXCST	Straight 5 m Cable (3 x 26 Gauge wire)	60 AC/75 DC	3 A	PUR	IP 68, III	M8
PXC90	90° 5 m Cable (3 x 26 Gauge wire)	60 AC/75 DC	3 A	PUR	IP 68, III	M8



World Class Supplier of Pneumatic Components



World Headquarters

USA Numatics, Incorporated

46280 Dylan Drive
Novi, Michigan 48377

P: 248-596-3200
F: 248-596-3201

Canada Numatics, Ltd

P: 519-758-2700
F: 519-758-5540

México - Ascomatica SA de CV

P: 52 55 58 09 56 40 (DF y Area metropolitana)
P: 01 800 000 ASCO (2726) (Interior de la República)
F: 52 55 58 09 56 60

Brazil Ascoval Ind.e Comercio Ltda

P: (55) 11-4208-1700
F: (55) 11-4195-3970