

# **150X Series**

## Insulation Testers

## Calibration Manual

November 2005 Rev. 2, 11/21

©2005 - 2021 Fluke Corporation. All rights reserved.

Specifications are subject to change without notice.

All product names are trademarks of their respective companies.

## LIMITED WARRANTY AND LIMITATION OF LIABILITY

Each Fluke product is warranted to be free from defects in material and workmanship under normal use and service. The warranty period is 1 year and begins on the date of shipment. Parts, product repairs, and services are warranted for 90 days. This warranty extends only to the original buyer or end-user customer of a Fluke authorized reseller, and does not apply to fuses, disposable batteries, or to any product which, in Fluke's opinion, has been misused, altered, neglected, contaminated, or damaged by accident or abnormal conditions of operation or handling. Fluke warrants that software will operate substantially in accordance with its functional specifications for 90 days and that it has been properly recorded on non-defective media. Fluke does not warrant that software will be error free or operate without interruption.

Fluke authorized resellers shall extend this warranty on new and unused products to end-user customers only but have no authority to extend a greater or different warranty on behalf of Fluke. Warranty support is available only if product is purchased through a Fluke authorized sales outlet or Buyer has paid the applicable international price. Fluke reserves the right to invoice Buyer for importation costs of repair/replacement parts when product purchased in one country is submitted for repair in another country.

Fluke's warranty obligation is limited, at Fluke's option, to refund of the purchase price, free of charge repair, or replacement of a defective product which is returned to a Fluke authorized service center within the warranty period.

To obtain warranty service, contact your nearest Fluke authorized service center to obtain return authorization information, then send the product to that service center, with a description of the difficulty, postage and insurance prepaid (FOB Destination). Fluke assumes no risk for damage in transit. Following warranty repair, the product will be returned to Buyer, transportation prepaid (FOB Destination). If Fluke determines that failure was caused by neglect, misuse, contamination, alteration, accident, or abnormal condition of operation or handling, including overvoltage failures caused by use outside the product's specified rating, or normal wear and tear of mechanical components, Fluke will provide an estimate of repair costs and obtain authorization before commencing the work. Following repair, the product will be returned to the Buyer transportation prepaid and the Buyer will be billed for the repair and return transportation charges (FOB Shipping Point).

**THIS WARRANTY IS BUYER'S SOLE AND EXCLUSIVE REMEDY AND IS IN LIEU OF ALL OTHER WARRANTIES, EXPRESS OR IMPLIED, INCLUDING BUT NOT LIMITED TO ANY IMPLIED WARRANTY OF MERCHANTABILITY OR FITNESS FOR A PARTICULAR PURPOSE. FLUKE SHALL NOT BE LIABLE FOR ANY SPECIAL, INDIRECT, INCIDENTAL OR CONSEQUENTIAL DAMAGES OR LOSSES, INCLUDING LOSS OF DATA, ARISING FROM ANY CAUSE OR THEORY.**

Since some countries or states do not allow limitation of the term of an implied warranty, or exclusion or limitation of incidental or consequential damages, the limitations and exclusions of this warranty may not apply to every buyer. If any provision of this Warranty is held invalid or unenforceable by a court or other decision-maker of competent jurisdiction, such holding will not affect the validity or enforceability of any other provision.

Fluke Corporation	Fluke Europe B.V.
P.O. Box 9090	P.O. Box 1186
Everett, WA 98206-9090	5602 BD Eindhoven
U.S.A.	The Netherlands

# Table of Contents

Introduction.....	1
Safety Information .....	2
Contact Fluke .....	3
General Specifications.....	3
Basic Maintenance .....	3
Clean the Product .....	3
Test the Batteries.....	4
Replace the Batteries and/or Fuse.....	4
Test the Display .....	5
Backlight Test.....	5
Keypad Test .....	6
Disassemble and Reassemble the Tester .....	6
Remove the Holster.....	7
Remove the Battery Door .....	7
Open the Bottom Case .....	8
Remove the PCA.....	8
Remove the Display .....	10
Replacing the LCD.....	11
Reassemble the Tester.....	11
Required Tools and Equipment .....	12
Performance Tests.....	13
Test the Voltage Function .....	13
Discharge Circuit Test.....	14
Test the Insulation Function.....	14
Insulation Resistance Accuracy Tests .....	15
Insulation Function, External Sense .....	16
Source Voltage Accuracy Test, "R" Nominal.....	16
Source Voltage Accuracy Test, Open Circuit .....	17
I Nominal Test .....	18
I Limit Test.....	18
Test the Ohm Function.....	19
2-Ohm Output Current Test.....	20
Open Circuit Voltage Test.....	20
Calibration Adjustment.....	20
Calibration Adjustment Counter.....	20
Calibration Adjustment Password .....	21
Change the Password .....	21
Restore the Default Password .....	21

Keys Used in the Calibration Steps ..... 22  
Calibration Adjustment Procedure ..... 22  
Service and Parts ..... 25

## Introduction

The Fluke Models 1503, 1507, and 1508 are battery-powered insulation testers (hereafter, Tester, Product, or DUT (Device Under Test)). These Testers meet CAT IV IEC 61010 standards. The IEC 61010 standard defines four measurement categories (CAT I to IV) based on the magnitude of danger from transient impulses. CAT IV Testers protect against transients from the primary supply level (overhead or underground utility service).

Although this manual contains calibration information for Models 1503, 1507, and 1508, all illustrations and examples show Model 1507. [Table 1](#) provides a description of all the symbols used in this manual.

The information provided in this manual includes:

- Warnings and Safety Information
- Basic Maintenance
- Performance Test Procedures
- Calibration Adjustment Procedure
- Replaceable Parts and Accessories

The information provided in this manual should only be used by qualified personnel. For complete operation instructions and additional safety information, refer to the *1507/1503 Insulation Testers Users Manual* or the *1508 Insulation Tester Users Manual*.

## Safety Information

### Warning

To prevent possible electrical shock or personal injury:

- Do not alter the Product and use only as specified, or the protection supplied by the Product can be compromised.
- Do not use the Tester or test leads if they appear damaged, or if the Tester is not operating properly. If in doubt, have the Tester serviced.
- Do not use test leads if they are damaged. Examine the test leads for damaged insulation and measure a known voltage.
- Use the correct terminals, function, and range for measurements.
- Measure a known voltage to verify the operation of the Tester.
- Do not apply more than the rated voltage, between the terminals or between each terminal and earth ground.
- Do not touch voltages >30 V ac rms, 42 V ac peak, or 60 V dc.
- Replace the battery when the low battery indicator shows  to prevent incorrect measurements.
- Disconnect circuit power and discharge all high-voltage capacitors before you test resistance, continuity, diodes, or capacitance.
- Do not use the Product around explosive gas, vapor, or in damp or wet environments.
- Keep fingers behind the finger guards on the probes.
- Do not operate the Product with covers removed or the case open. Hazardous voltage exposure is possible.
- Remove all probes, test leads, and accessories before the battery door is opened.
- Comply with local and national safety requirements when you work in hazardous locations.
- Use proper protective equipment, as required by local or national authorities when you work in hazardous areas.
- Do not work alone.
- Use only specified replacement fuses.
- Check the test leads for continuity before use. Do not use if the readings are high or noisy.

**Table 1. Symbols**

~	AC (Alternating Current)	⏏	Earth Ground
—	DC (Direct Current)	⏏	Fuse
⚠	WARNING: risk of electric shock.	□	Double Insulated
+	Battery (Low battery when shown on display.)	⚠	Important information; see manual
⚠ > 660V	WARNING. Do not apply greater than 660 Volts.		

## Contact Fluke

Fluke Corporation operates worldwide. For local contact information, go to our website: [www.fluke.com](http://www.fluke.com)

To register your product, view, print, or download the latest manual or manual supplement, go to our website [www.fluke.com](http://www.fluke.com).

Fluke Corporation  
P.O. Box 9090  
Everett, WA 98206-9090

+1-425-446-5500

[fluke-info@fluke.com](mailto:fluke-info@fluke.com)

## General Specifications

For specifications, see the Product user manual located at [www.fluke.com](http://www.fluke.com)

## Basic Maintenance

This basic maintenance section contains tests and procedures that require no equipment other than the Tester and some items such as fuses and batteries. Also, internal access is limited to the battery and fuse compartment.

## Clean the Product

To clean the Product, wipe it with a damp cloth and mild detergent. Do not use abrasives or solvents. Dirt or moisture on the terminals can affect readings.



# Static Awareness



Semiconductors and integrated circuits can be damaged by electrostatic discharge during handling. This notice explains how to minimize damage to these components.

1. Understand the problem.
2. Learn the guidelines for proper handling.
3. Use the proper procedures, packaging, and bench techniques.

Follow these practices to minimize damage to static sensitive parts.

## Warning

**To prevent electric shock or personal injury. De-energize the product and all active circuits before opening a product enclosure, touching or handling any PCBs or components.**



- Minimize handling.
- Handle static-sensitive parts by non-conductive edges.
- Do not slide static-sensitive components over any surface.
- When removing plug-in assemblies, handle only by non-conductive edges.
- Never touch open-edge connectors except at a static-free work station.

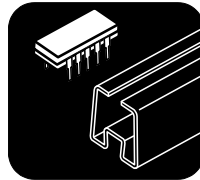

- Keep parts in the original containers until ready for use.
- Use static shielding containers for handling and transport.
- Avoid plastic, vinyl, and Styrofoam® in the work area.

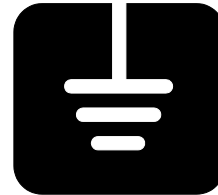



- Handle static-sensitive parts only at a static-free work station.
- Put shorting strips on the edge of the connector to help protect installed static-sensitive parts.
- Use anti-static type solder extraction tools only.
- Use grounded-tip soldering irons only.



## Test the Batteries

### Warning

**To prevent possible electrical shock or personal injury, replace the battery when the low battery indicator () shows to prevent incorrect measurements. A weak battery can cause false readings.**

The Tester continuously monitors battery voltage. If the low battery icon () appears on the display, there is minimal battery life left. Before any performance test, check the batteries and replace if necessary.

This procedure tests the batteries under load:

1. With no probes inserted, turn the rotary switch to the  V position.
2. Press the blue key to initiate the fully loaded battery test. The voltage function display clears and the measured battery voltage shows on the primary display for two seconds, the voltage display then returns. The displayed voltage should be within 5.5 V to 6.2 V. If voltage is <5.2 V, replace the batteries and repeat the test.

## Replace the Batteries and/or Fuse

Replace the fuse and batteries as shown in [Figure 1](#). Follow the steps below to replace the batteries.

### Warning

**To prevent possible electrical shock, personal injury, or damage to the Tester:**

- **Use only specified replacement fuses.**
  - **When you replace the fuse or batteries, turn the rotary switch to OFF and remove the test leads from the terminals.**
1. Remove the yellow holster from the Tester, see [Remove the Holster](#).
  2. To remove the battery door, use a standard screwdriver to turn the battery door lock until the unlock symbol aligns with the arrow.
  3. Lift the bottom of the battery door away from the Tester to access the fuse and battery compartment.
  4. Remove and replace the batteries and/or fuse as shown in [Figure 1](#).
  5. Replace the battery door and turn the battery door lock until the lock symbol () aligns with the arrow.
  6. Position the bottom of the Tester in the bottom of the holster and press the top of the Tester firmly into the holster.

Figure 1. Replace the Batteries



## Test the Display

Press and hold the blue key, and simultaneously turn the DUT on. Compare the display with the example in Figure 2. Check all segments for clarity and contrast.

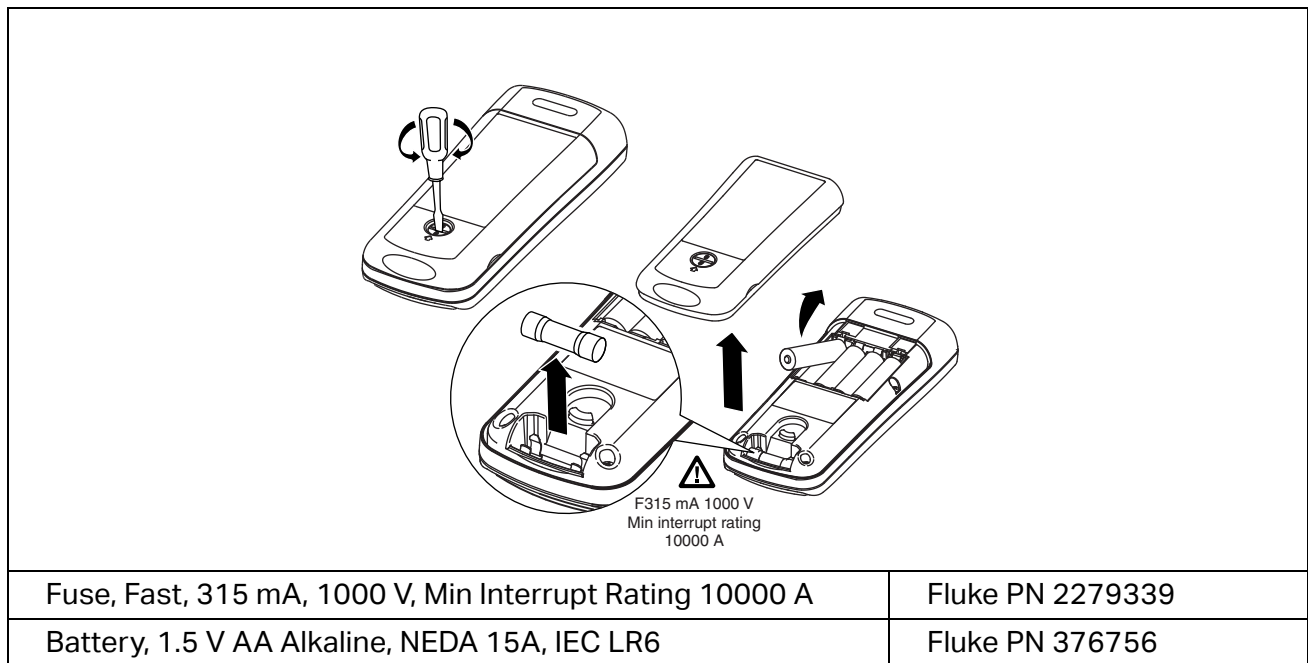
Figure 2. Display Test

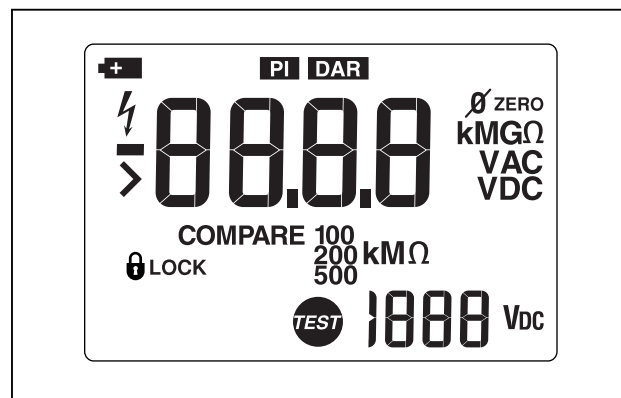

## Backlight Test

The display backlight is a toggle function controlled by ☀. Each press of ☀ causes the backlight to change states, on to off or off to on. To test the backlight:

1. Press ☀ twice to verify that the toggle function works.
2. Turn the backlight off.

## Keypad Test

The keypad consists of six keys located above the rotary switch. To test the keypad:

1. Turn the rotary switch to **V** and momentarily press each of the six keys. Each press of an operational key causes the Tester to beep. No beep in response to a key press indicates a defective keypad.
2. Reset the Tester. Turn the Tester rotary switch to **OFF** and then to any other position.

## Disassemble and Reassemble the Tester

This section provides instructions to disassemble and reassemble the Tester. The instructions are limited to major replaceable assemblies and do not include component-level detail. See [Figure 3](#) for an exploded view of the major assemblies. Also, the emphasis is placed on disassembly. However, when appropriate, an italicized entry at the end of each disassembly procedure provides critical hints for reassembly.

**Figure 3. Disassemble the Tester**

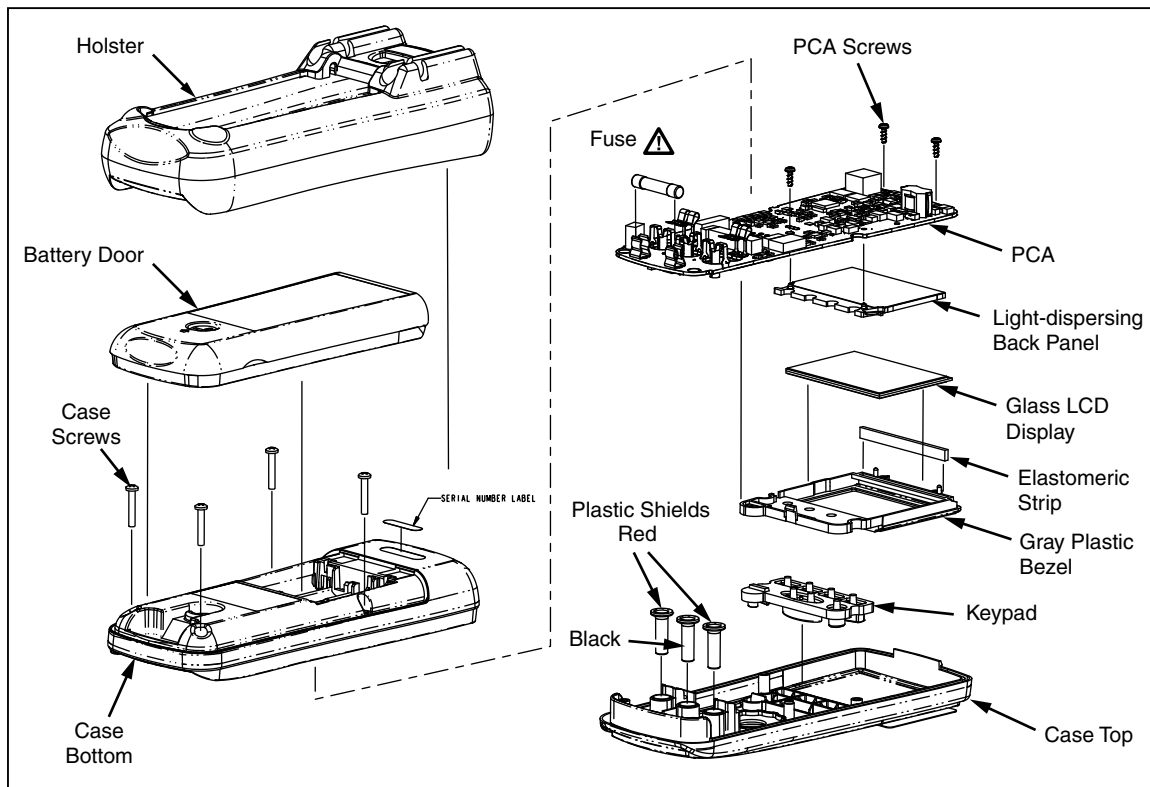

## Remove the Holster

The standard Tester comes with a snug-fitting yellow rubber holster. The holster protects the Tester from rough handling and normally remains on the Tester. The first step to disassemble the Tester is to remove the holster.

To remove the holster:

1. With the Tester face up, place your thumbs on the top corners of the holster and firmly grasp the Tester.
2. Use both thumbs to push the holster up and over both corners of the Tester.
3. Continue to push on the holster until both of its inside corners rest on top of the Tester.
4. Rest the heel of one hand behind the display and place all four fingers of the same hand along the upper front edge of the holster.
5. Firmly grasp the Tester with the other hand, and use your fingers to peel the holster over the top of the Tester.
6. Slide the Tester up and out of the holster.

### Note

*To install the holster, position the bottom of the Tester in the bottom of the holster, and press the top of the Product firmly into the holster.*

## Remove the Battery Door

### Warning

**To prevent possible electrical shock, personal injury, or damage to the Tester, when you replace the fuse or battery, turn the rotary switch to OFF and remove the test leads from the terminals.**

With the holster removed, the next step to disassemble the Tester is to remove the battery door. To remove the door:

1. Locate the black slotted lock on the lower rear of the Tester.
2. Use a standard screwdriver to turn the battery-door lock until the unlock symbol aligns with the arrow. The door is now unlocked.
3. Lift the bottom of the battery door away from the Tester, this provides access to the fuse and battery compartment.
4. If necessary, remove and replace the batteries and/or fuse as shown in [Figure 1](#).

### Note

*To install the battery door, slide the top of the door into position and turn the battery door lock until the lock symbol (🔒) aligns with the arrow to secure the door.*

## Open the Bottom Case

With the battery door removed, the next step to disassemble the Tester is to remove the bottom case. To remove the bottom case:

*Note*

*When you remove the back cover, you do not have to remove the fuse or the batteries.*

1. Locate the four Philips head screws on the bottom case (two are next to the batteries and two are next to the fuse).
2. Use a Philips screwdriver to remove the four screws.
3. Separate the front and bottom cases at the fuse end of the Tester. Tilt the free end of the cover up and lift it away from the top case.

*Note*

*To install the bottom case, first, position and press together the display end of the top and bottom cases. Before you install all four screws, press the fuse end of the covers together.*

## Remove the PCA

With the bottom case removed, the next step to disassemble the Tester is to remove the printed circuit assembly (PCA). Refer to [Figure 3](#) for the exploded part view and use this procedure to remove the PCA:

1. One Philips screw attaches the PCA to the top case. Locate the screw near the center of the PCA and remove it.
2. Two chrome-plated springs on the PCA form an electrical connection (clip) to the two recessed **INSULATION(+)** terminals on the top case. Pull each of the springs back and away from the terminals to carefully break these connections. See [Figure 4](#).

Figure 4. Insulation Terminal Clips

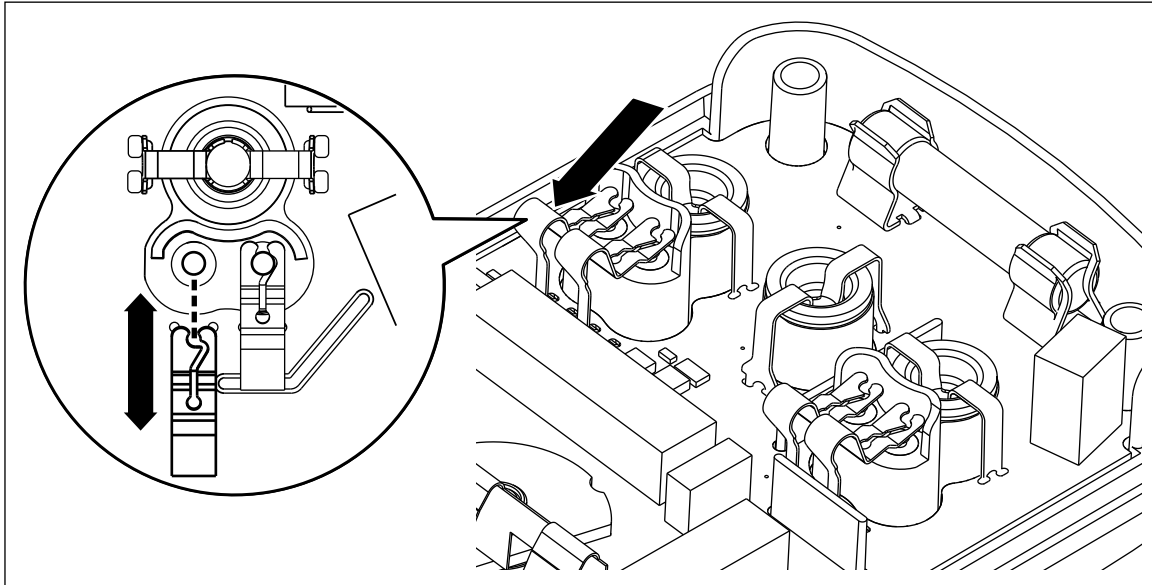

3. With one hand over the PCA, roll the top case over (face up) and lift it away from the PCA.

*Note*

*Two red and one black plastic shields you attisolate the user from the input terminals. With the PCA removed, these shields are loose and can fall away from the PCA.*

4. Remove and set aside all three shields for use during reassembly.

**⚠️⚠️ Warning**

**To prevent possible electrical shock or personal injury, make sure the plastic input terminals are properly positioned on the PCA before you attach it to the top case.**

To install the PCA:

1. With the PCA face-up, place all three plastic shields into position on the PCA.
2. Lower the top cover onto the PCA and roll both parts over (PCA up).
3. Connect (snap) the chrome plated springs to the **INSULATION** terminals.
4. Install the screw that attaches the PCA to the top case.

## Remove the Display

With the PCA removed, the final step to disassemble the Tester is to remove the display assembly from the PCA. Refer to [Figure 5](#) and use this procedure to remove the display assembly:

1. Remove the two screws from the display end of the PCA.
2. Hold the PCA face down with the fuse-end of the PCA toward you. Locate the screw-hole near the center of the assembly. This hole is the one used to attach (with a screw) the PCA to the top case.
3. Locate the gray plastic tab just above and to the left of the hole. Use your thumbnail to press the tab down and toward the display end of the PCA. This releases the LCD assembly from the PCA.

### **⚠ Caution**

**To prevent damage to the plastic guide pins on the display assembly, keep the display assembly parallel to the PCA when you separate the two parts.**

4. Without tilting the PCA, lift it straight up and away from the display assembly.
5. To keep loose parts from falling away from the display assembly, keep it face-down, and set it in a safe place.

**Figure 5. Access the LCD**

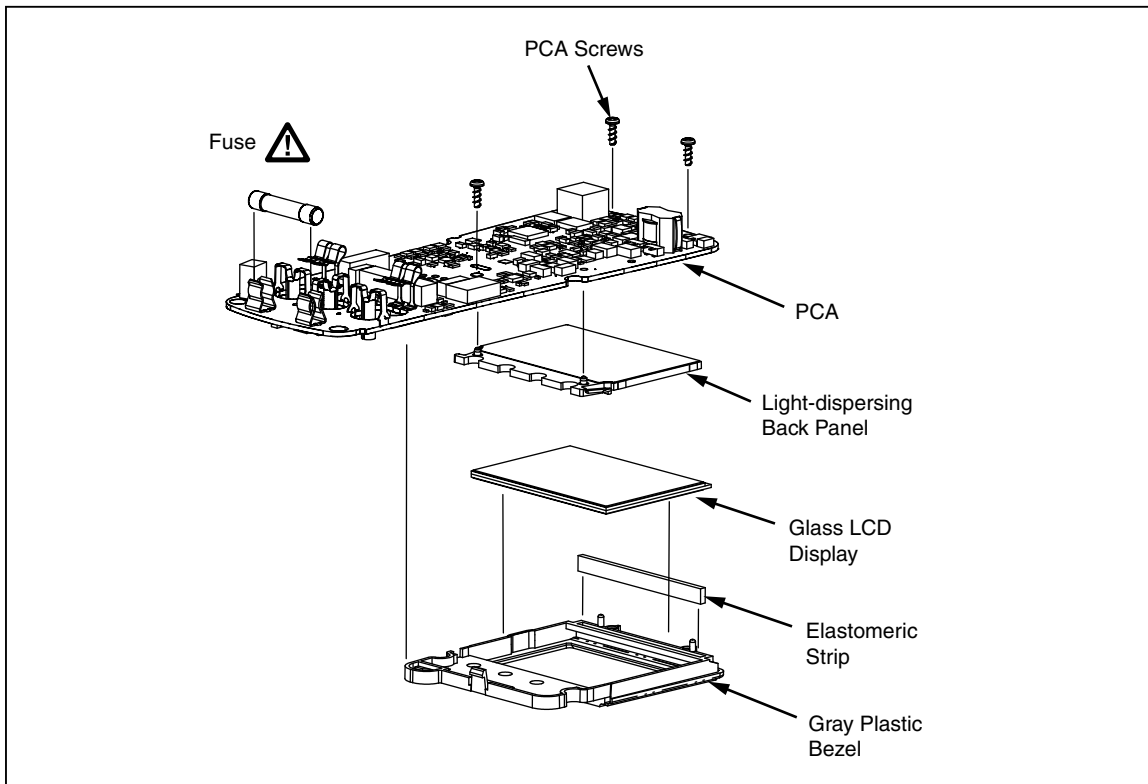

## Replace the LCD

The display assembly consists of four pieces as shown in [Figure 5](#):

- Translucent light-dispersing back panel
- Flexible elastomeric conducting strip
- Plastic bezel for housing the components of the assembly
- Glass LCD

With the display assembly removed from the PCA, use this procedure to replace the LCD:

1. Lift the translucent light dispersing back panel from the plastic bezel.
2. Remove the pink and black elastomeric strip from its slot in the bezel.
3. Remove the old glass LCD from the bezel.

### Note

*Make sure the new LCD is clean (free of lint and fingerprints) before you place it in position in the bezel.*

4. Position the new glass LCD in the bezel; the silver face should face the rear, and the stepped portion of the glass should be directly under the elastomeric slot on the bezel.
5. Drop the elastomeric strip into its slot on the bezel.
6. Position the translucent light-dispersing back panel over the silver side of the glass LCD. Make sure the guide pins on the light dispersing back panel are facing up and that they are on the side opposite the elastomeric strip.
7. Hold the display assembly (face down) in one hand and position the PCA (fuse side up) over the bezel. Match the guide holes in the PCA with the plastic guide pins on the bezel and the translucent light dispersing back panel. After the display assembly is in position, press (below the display) the bezel against the PCA to lock it into place. Listen for the tab on the bezel to snap (lock) into position on the PCA.
8. Install the two screws that attach the PCA to the bezel to secure the PCA to the display assembly. These screws also ensure contact between the glass LCD, the elastomeric strip, and the PCA.

## Reassemble the Tester

To reassemble the Tester, logically reverse the previous disassembly procedures. In the process, make sure to re-establish all electrical connections, specifically, the elastomeric strip for the LCD, the red and black plastic shields for the input terminals, and the two spring contacts for the Insulation Test Probe. Also make sure all parts are correctly aligned and positioned. Do not force-fit any of the parts into position.



## Required Tools and Equipment

Table 2 and Table 3 list the required equipment used in the Performance Test and Calibration Adjustments. If a recommended model is unavailable, use a substitute with equivalent or better specifications.

**Table 2. Required Performance Test Equipment**

Equipment	Required Characteristics	Recommended Model
Calibrator	<p><b>AC Voltage Range:</b> 0 V – 600 V Accuracy: <math>\pm 0.5\%</math></p> <p><b>Frequency Range:</b> 50 Hz – 400 Hz Accuracy: <math>\pm 3\%</math></p> <p><b>DC Voltage:</b> 0 V – 600 V Accuracy: <math>\pm 0.5\%</math></p> <p><b><math>\Omega</math> Range:</b> 0 <math>\Omega</math> – 20 k<math>\Omega</math> Accuracy: <math>\pm 0.37\%</math></p> <p><b>Insulation Resistance:</b> 50 k<math>\Omega</math> – 10 G<math>\Omega</math> Accuracy: <math>\pm 0.37\%</math></p>	Fluke 5320A/VLC
Meter Function	<p><b>DC Volts:</b> 0 V – 1500 V Accuracy: <math>\pm 5\%</math></p> <p><b>DC Current:</b> 0 mA – 2 mA Accuracy: <math>\pm 1\%</math></p>	
Ohm Meter	<b><math>\Omega</math> Range:</b> 2000 $\Omega$ – 3000 $\Omega$	Fluke 189

**Table 3. Required Calibration Adjustment Equipment**

Equipment	Required Characteristics	Recommended Model
Calibrator	<p><b>DC Voltage:</b> 0 V – 750 V Accuracy: <math>\pm 5\%</math></p> <p><b>DC Current:</b> 0 mA – 2 mA Accuracy: <math>\pm 0.37\%</math></p>	Fluke 5520A
Precision Resistor	Resistor, Wirewound, 2 $\Omega$ k, $\pm 0.1\%$ , 1 W, 50 ppm	IRC PN RWR89S2R00BR

## Performance Tests

The subsequent series of tests comprise a performance test to verify the accuracy of the Tester (DUT) and its performance level. The performance test is recommended as an acceptance test for incoming inspection and as a calibration procedure to periodically ensure the accuracy of the Tester. Fluke recommends that you run the performance test at least once a year.

No adjustments are required during the performance test, and it is not necessary to open the case. If the Tester does not pass all parts of the performance tests, repair and/or calibration adjustment are required. A calibration adjustment procedure is given in [Calibration Adjustment](#). If significant repairs are required, contact Fluke, see [Contact Fluke](#). If user repairs are appropriate, refer to [Service and Parts](#).

### Test the Voltage Function

To verify the accuracy of the voltage measure function:



1. Turn the DUT rotary switch to the **V** function.
2. Connect the Fluke 5320A voltage output terminals to the **INSULATION** and **COM** terminals of the DUT.
3. Set the 5320A for the voltage output function ().
4. Apply the input level for each step listed in [Table 4](#).
5. Compare the reading on the DUT display with the display reading in [Table 4](#).
6. If the display reading falls outside of the limits shown in [Table 4](#), the Tester does not meet specification.

**Table 4. Voltage Accuracy Tests**

Step	Function	Range	Applied Input	Display Reading	
				Low Limit	High Limit
1	V	600.0 V	3 V, 0 Hz	2.7	3.3
2			8 V, 0 Hz	7.5	8.5
3			8 V, 400 Hz	Display must show V ac annunciator	
4			50 V, 0 Hz	48.7	51.3
5			100 V, 0 Hz	97.7	102.3
6			250 V, 0 Hz	244.7	255.3
7			500 V, 0 Hz	489.7	510.3
8			120 V, 60Hz	117.3	122.7
9			230 V, 50 Hz	225.1	234.9
10			600 V, 400 Hz	587.7	612.3

## Discharge Circuit Test

The subsequent Discharge Circuit Test is a safety related test that verifies input jack wiring to the PCA, the RSOB contacts, RSOB PCA pads, and other active discharge components on the PCA.

1. Place a shorting bar across the DUT **COM** and **INSULATION** input terminals.
2. Set the DUT rotary switch to 1000 V, and press .
3. Release  and remove the short from the DUT input terminals.

### Caution

**To avoid damage to the DMM, DO NOT press the DUT  key when you do the next steps.**

4. Connect the test DMM to the DUT **INSULATION** and **COM** terminals.
5. Set the test DMM to  $\Omega$  function.
6. Make sure that the test DMM reads between 2000  $\Omega$  and 3000  $\Omega$ .

## Test the Insulation Function

### Warning

**To prevent possible electrical shock or personal injury, avoid contact with the DUT when you test the insulation function. When the Tester is in the Insulation function, if you press the  key, it produces a potentially dangerous voltage at the DUT insulation output terminals.**

### Caution



**To prevent damage to the calibrator, do not attempt to use the 5500A, 5520A, or other standard calibrator for the insulation tests.**

### Caution

**To prevent damage to the Fluke 5320A, make sure to select the High Ohms function before you push the  on the DUT.**

### Insulation Resistance Accuracy Tests

To test the insulation resistance accuracy, complete the test steps in [Table 5](#) with this procedure:

1. Connect the DUT **INSULATION** and **COM** terminals to the Fluke 5320A High Resistance output terminals.
2. Set the Fluke 5320A to the high resistance source function ().
3. Turn the DUT rotary function switch to an **INSULATION** function.
4. Select the DUT insulation voltage range per [Table 5](#).
5. Apply the Fluke 5320A output called out in [Table 5](#).
6. Press  on the DUT.
7. Make sure that the DUT reads within the display reading limits listed in [Table 5](#).

**Table 5. Insulation Resistance Accuracy Test**

Step	Insulation Voltage Range	Applied	Display Units	Display Reading Limits	
				1503	1507/1508
1	1000 V	9 GΩ	MΩ	N/A	7.8 to 10.2
2	1000 V	1.9 GΩ		1862 to 1938	N/A
3	1000 V	1 MΩ		0.5 to 1.5	0.5 to 1.5
4	1000 V	49 MΩ		47.5 to 50.5	47.8 to 50.2
5	1000 V	60 MΩ		58.3 to 61.7	58.6 to 61.4
6	500 V	500 kΩ		0.44 to 0.56	0.44 to 0.56
7	250 V	250 kΩ		N/A	0.20 to 0.30
8	100 V	100 kΩ		N/A	0.05 to 0.15
9	50 V	50 kΩ		N/A	0.0 to 0.10



**Insulation Function, External Sense**

This test verifies that the Tester will sense a voltage >30 V when present on the circuit under test.

1. Connect the DUT **INSULATION** and **COM** output terminals to the Fluke 5320A voltage output terminals.
2. Set the 5320A to the voltage output function ().
3. Turn the DUT rotary function switch to an insulation function.
4. Apply 35 V, 50 Hz to the DUT.
5. Verify that the DUT displays >30 V in the primary display, and the red LED lightning bolt comes on.

**Source Voltage Accuracy Test, "R" Nominal**

Complete the test steps in [Table 6](#) to verify source voltage of the insulation function under load. If you use the Fluke 5320A, use the high resistance function to verify source voltage.

1. Connect the Fluke 5320A high resistance output terminals to the DUT **INSULATION** and **COM** terminals.
2. Put the Fluke 5320A in the high resistance function (.
3. Set the Fluke 5320A for the applied load shown in [Table 6](#) for Steps 1-5.
4. Press  and verify that the DUT and Fluke 5320A voltage reads within the limits of [Table 6](#). Record both readings.
5. Use the Fluke 5320A voltage reading as the reference and calculate the DUT voltage reading error %,  $(5320A\ V - DUT\ V / 5320A\ V) \times 100$ , and record for later use.

**Table 6. Source Voltage Accuracy Test, R-Nominal**

Step	DUT Function	Tester Range	Applied Load	5320A Display Reading	DUT Display Reading	DUT Voltage Reading Error %
1	Insulation	1000 V	1 MΩ	1000 V to 1200 V	1000 V to 1200 V	
2	Insulation	500 V	500 k	500 V to 600 V	500 V to 600 V	
3	Insulation (1507/1508)	250 V	250 kΩ	250 V to 300 V	250V to 300 V	
4	Insulation (1507/1508)	100 V	100 kΩ	100 V to 120 V	100 V to 120 V	
5	Insulation (1507/1508)	50 V	50 kΩ	50 V to 60 V	50 V to 60 V	

### Source Voltage Accuracy Test, Open Circuit

Determine the open circuit source voltage accuracy by calculation. use the DUT Voltage Reading Error % previously noted. Complete the subsequent test to verify the actual open circuit source voltage.

1. Remove test leads from the DUT terminals.
2. Set the DUT rotary function switch to an insulation test function.
3. Press **TEST** and record the DUT display reading for each step in [Table 7](#).
4. Use the previously determined DUT Voltage Reading Error % to calculate the actual open circuit output voltage for each voltage range. Make sure that the calculated value is within the limits shown in [Table 7](#). The formula is Recorded DUT Display Reading x DUT Voltage Reading Error % + Recorded DUT Display Reading.

**Table 7. Source Voltage Accuracy Test, Open Circuit**

Step	Function	Range	Recorded DUT Display Reading	Calculated DUT Output Voltage Limits
1	Insulation	1000 V		1000 V to 1200 V
2	Insulation	500 V		500 V to 600 V
3	Insulation (1507/1508)	250 V		250 V to 300 V
4	Insulation (1507/1508)	100 V		100 V to 120 V
5	Insulation (1507/1508)	50 V		50 V to 60 V

### I Nominal Test

This test verifies the ability of the DUT to maintain the nominal insulation test current while loaded.

1. Connect the Fluke 5320A high resistance output terminals to the DUT **INSULATION** and **COM** terminals.
2. Set the 5320A to the high resistance source function ( $\overline{\text{HI}}\Omega$ ).
3. Set the 5320A for the Applied Load called out in [Table 8](#) for Steps 1-5.
4. Press  $\text{TEST}$  and make sure that the Fluke 5320A current reading is >1000.0  $\mu\text{A}$  for steps 1-5.

**Table 8. I Nominal Test/Limit Test**

Step	Function	Range	Applied Load	5320A Current Reading
1	Insulation	1000 V	1 M $\Omega$	>1000.0 $\mu\text{A}$
2	Insulation	500 V	500 k $\Omega$	
3	Insulation (1507/1508)	250 V	250 k $\Omega$	
4	Insulation (1507/1508)	100 V	100 k $\Omega$	
5	Insulation (1507/1508)	50 V	50 k $\Omega$	>1000.0 $\mu\text{A}$

### I Limit Test

This test verifies the internal insulation function of the DUT and current limit operation.

1. Connect the Fluke 5320A high resistance output terminals to the DUT **INSULATION** and **COM** terminals.
2. Set the Fluke 5320A to the high resistance source function ( $\overline{\text{HI}}\Omega$ ) and 50 k $\Omega$ .
3. Set the DUT rotary switch to the 1000 V range.
4. Press and hold  $\text{TEST}$ .
5. The Fluke 5320A current reading should be <2000.0  $\mu\text{A}$ .

## Test the Ohm Function

### Earth Bond Resistance Accuracy Tests

To test earth bond resistance accuracy, complete the test steps in [Table 9](#), with this procedure:

1. Connect the DUT **COM** and  $\Omega$  terminals to the Fluke 5320A low resistance output terminals in a 2-wire configuration.
2. Set the Fluke 5320A to the low resistance source function ( $\overline{LO\Omega}$ ).
3. Turn the DUT rotary function switch to the  $\Omega$  function.
4. Apply the calibrator output listed in [Table 9](#), Steps 1-3. Prior to step 1, set the 5320A Ohms output to **Short** and press the ZERO button on the DUT. Change the 5320A Ohms to 2-Wire mode.
5. Press  $\text{TEST}$  and make sure that the DUT reads within the display reading limits shown in [Table 9](#).
6. Connect the Fluke 5320A high resistance output terminals to the DUT **COM** and  $\Omega$  terminals.
7. Set the Fluke 5320A to the high resistance source function ( $\overline{HI\Omega}$ ).
8. Press  $\text{TEST}$  and make sure that the reading is within the display reading limits for [Table 9](#), Step 4.

**Table 9. Earth Bond Resistance Tests**

Step	Tester Range	Applied	Display Units	Display Reading	
				Low Limit	High Limit
1	20.00 $\Omega$	2.0 $\Omega$	$\Omega$	1.94	2.06
2	2000 $\Omega$	810.0 $\Omega$	$\Omega$	795	825
3	2000 $\Omega$	990.0 $\Omega$	$\Omega$	972	1008
4	20.00 k $\Omega$	18.0 k $\Omega$	k $\Omega$	17.70	18.30



## 2-Ohm Output Current Test

This procedure verifies the minimum current for a 2- $\Omega$  Load in the continuity function:

1. Connect the Fluke 5320A low resistance output terminal to the DUT **COM** and  $\Omega$  terminals.
2. Set the Fluke 5320A to the low resistance source function ( $\overline{LO\Omega}$ ) and 2- $\Omega$  output.
3. Set the DUT rotary function switch to the  $\Omega$  function.
4. Press the DUT **TEST**. The Fluke 5320A current reading should be >200 mA.

## Open Circuit Voltage Test

This test confirms that the open circuit voltage for the DUT  $\Omega$  function is within limits.

1. Connect the Fluke 5320A **V** and **COM** meter terminals directly to the DUT  $\Omega$  and **COM** terminals. Observe the correct polarity.
2. Set the Fluke 5320A to the **METER** mode and dc volts.
3. Set the DUT rotary function switch to the  $\Omega$  function.
4. Press **TEST** and verify that the Fluke 5320A voltage reading is >4.0 V but <8.0 V.

# Calibration Adjustment

The Tester features closed-case calibration adjustment and uses known reference sources. The Tester measures the applied reference source, calculates correction factors and stores the correction factors in nonvolatile memory.

The subsequent sections present the features and Tester function keys used in the calibration adjustment procedure. Do the calibration adjustment procedure if the Tester fails any performance test listed earlier in this manual.

## Calibration Adjustment Counter

The Tester contains a calibration adjustment counter. The counter increments each time you complete a calibration adjustment procedure. The value in the counter can be recorded and used to show that no adjustments have been made during a calibration cycle.

Use these steps to view the calibration counter of the Tester.

1. Hold down **LOCK** and turn the rotary function switch from **OFF** to **V**. The Tester displays **[AL**.
2. Press the blue key **[ ]** once to see the calibration counter. For example, **n003**.
3. Turn the rotary function switch to **OFF**.

## Calibration Adjustment Password



Enter the correct four-key password to start the calibration adjustment procedure. You can change the password or reset to the default as described in below. The default password is 1234.

### Change the Password

To change the Tester password:

1. Hold down **LOCK**, turn the rotary function switch from **OFF** to **V**. The Tester displays **RL**.
2. Press the blue key once to see the calibration counter.
3. Press the blue key again to start the password entry. The Tester displays ----.
4. The Tester keys represent the digits indicated below when you enter or change the password:

Blue Key = 1    **LOCK** = 2     = 3    **TEST** = 4

5. Press the four keys to enter the old password. When you change the password for the first time, press the blue key (1), **LOCK** (2),  (3), **TEST** (4).
6. Press  to change the password. The Tester displays ---- if the old password is correct. If the password is not correct, the Tester emits a double beep, displays ---- and the four-key password must be entered again. Repeat step 4.
7. Press the four keys of the new password.
8. Press the blue key to store the new password.

### Restore the Default Password

If you forget the calibration password, restore the default password (1234) with these steps:

#### Warning

**To prevent electrical shock or personal injury, remove the test leads and any input signal before you remove the bottom case of the Tester.**

1. Remove the back case from the DUT. Leave the PCA in the top case.
2. Apply 6.0 V across the battery contact pads (J8) + and – on the PCA. See [Figure 6](#).
3. Short across the Cal keypad (S8) on the back of the PCA. See [Figure 6](#).
4. Turn the rotary knob from **OFF** to **V**. The DUT will beep and display **RL**. The default password is now restored.
5. Remove the 6.0 V supply, turn the rotary switch to **OFF**, and install the back case on the DUT.

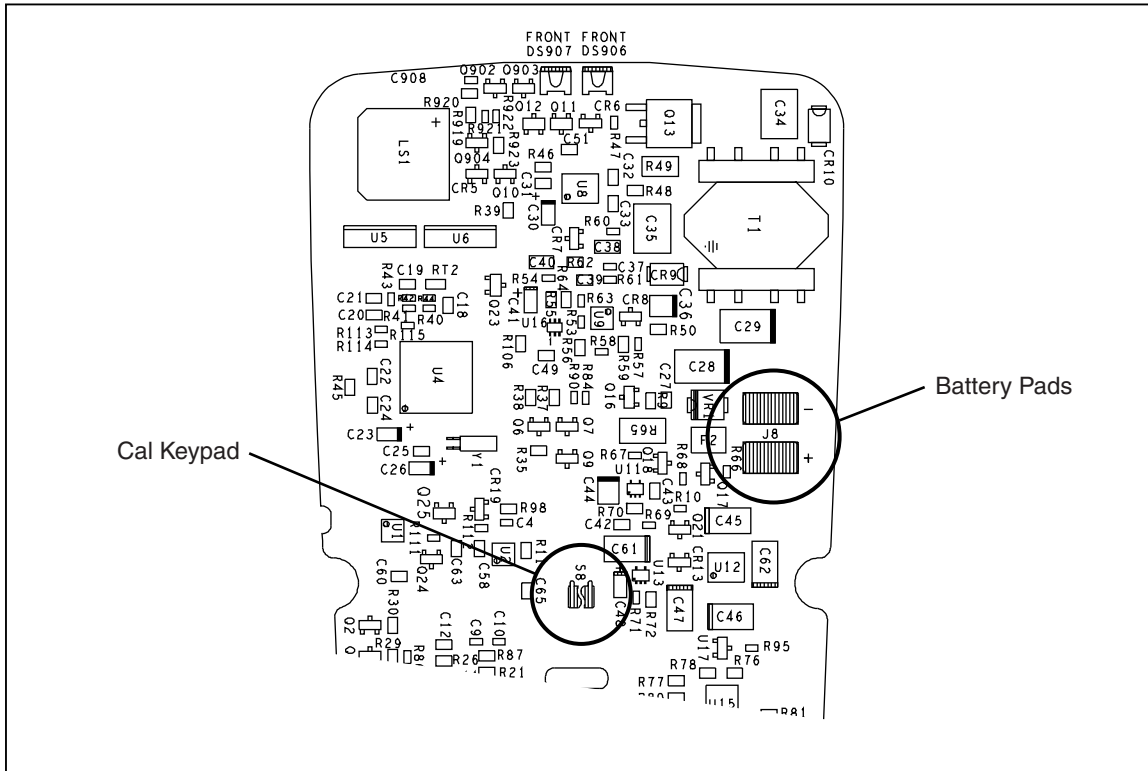

Figure 6. Restore the Default Password



## Keys Used in the Calibration Steps

The Tester keys behave as follows when you do the calibration adjustment procedure:



 stores the calibration value and advances to the next step.

 ignores the calibration value and advances to the next step.  is also used to exit the calibration function after the calibration adjustment sequence is complete.

## Calibration Adjustment Procedure

Use these steps to make calibration adjustments to the Tester. If the Tester is turned off before completion of the adjustment procedure, the calibration constants are not changed.

1. Remove batteries from DUT battery compartment. Connect a +5.0 V lab supply to the + and – battery terminals.
2. Hold down **[LOCK]**, turn the rotary function switch from **OFF** to **VAC**. The Tester displays **[AL]**.
3. Press the blue button once to see the calibration counter.
4. Press blue button again to start the password entry. --- appears on the display.
5. Press four keys to enter the password.
6. Press the blue button to go to the first calibration step. The Tester displays **[ - 0 ]** if the password is correct. If the password is not correct, the Tester emits a double beep, displays ---- and you must enter the password again. Repeat step 4.

7. Use [Table 10](#) and apply the input value listed for each calibration adjustment step. For each step, position the rotary function switch and apply the input to the terminals as indicated in the table.
8. After you apply each input, press  to accept the value and proceed to the next step ( and so forth).

*Note*

*After you press , wait until the step number advances before you change the calibrator source or turn the Tester rotary function switch. If the Tester rotary function switch is not in the correct position, or if the measured value is not within the anticipated range of the input value, the Tester emits a double beep and will not continue to the next step. Some adjustment steps take longer to execute than others (10 seconds to 15 seconds). For these steps, the Tester beeps when the step is complete. Not all steps have this feature.*

9. After the final step, the display shows **End** to indicate that the calibration adjustment is complete. Press  to go to meter mode.

*Note*

*Set the calibrator to standby before you change the function switch position and or after you complete adjustment of each function. If the calibration adjustment procedure is not completed correctly, the Tester will not operate correctly.*

**Table 10. Calibration Adjustment Steps**

Switch Position	Input Terminal	Adjustment Step	Input Value
1000 V Insulation	+ : COM – : A gnd (remote test probe pin)	C-01	0 mA, 0 Hz
		C-02	15 $\mu$ A, 0 Hz
		C-03	20 $\mu$ A, 0 Hz
		C-04	1.8 mA, 0 Hz
Continuity		C-05	0.5 mA, 0 Hz
		C-06	5.0 mA, 0 Hz
		C-07	0.5 mA, 0 Hz
		C-08	5.0 mA, 0 Hz
		C-09	5.0 mA, 0 Hz <sup>[2]</sup>
		C-10	300 mA, 0 Hz <sup>[2]</sup>
Volts	+ : Volts Input	C-11	25.0 V, 0 Hz
	– : COM	C-12	750 V, 0 Hz
Continuity	+ : Continuity Input	C-13	0.5 V, 0 Hz
	– : COM	C-14	5.0 V, 0 Hz
1000 V Insulation	None	C-15	
Continuity	+ : Continuity Input – : COM	C-16	2.00 $\Omega$ (Use external resistor, 0.1 %, 1 W, 50 PPM) <sup>[1]</sup>
Any	+ : Battery + Terminal – : Battery – Terminal	C-18	+ 5 V
<p>[1] Must certify that this resistor is within 1.998 <math>\Omega</math> to 2.002 <math>\Omega</math>. This resistor should be mounted directly to the Tester <math>\Omega</math> and COM terminals to minimize lead resistance.</p> <p>[2] Wait at least 40 seconds before hitting the TEST button.</p>			

## Service and Parts

User service is limited to parts replacements. [Table 11](#) identifies the replacement parts used by all models. [Table 12](#), [Table 13](#), and [Table 14](#) identify the replacement parts unique to each model. [Figure 7](#) shows the location of each part. To order replacement parts refer to [Contact Fluke](#).

Figure 7. 150X Replacement Parts

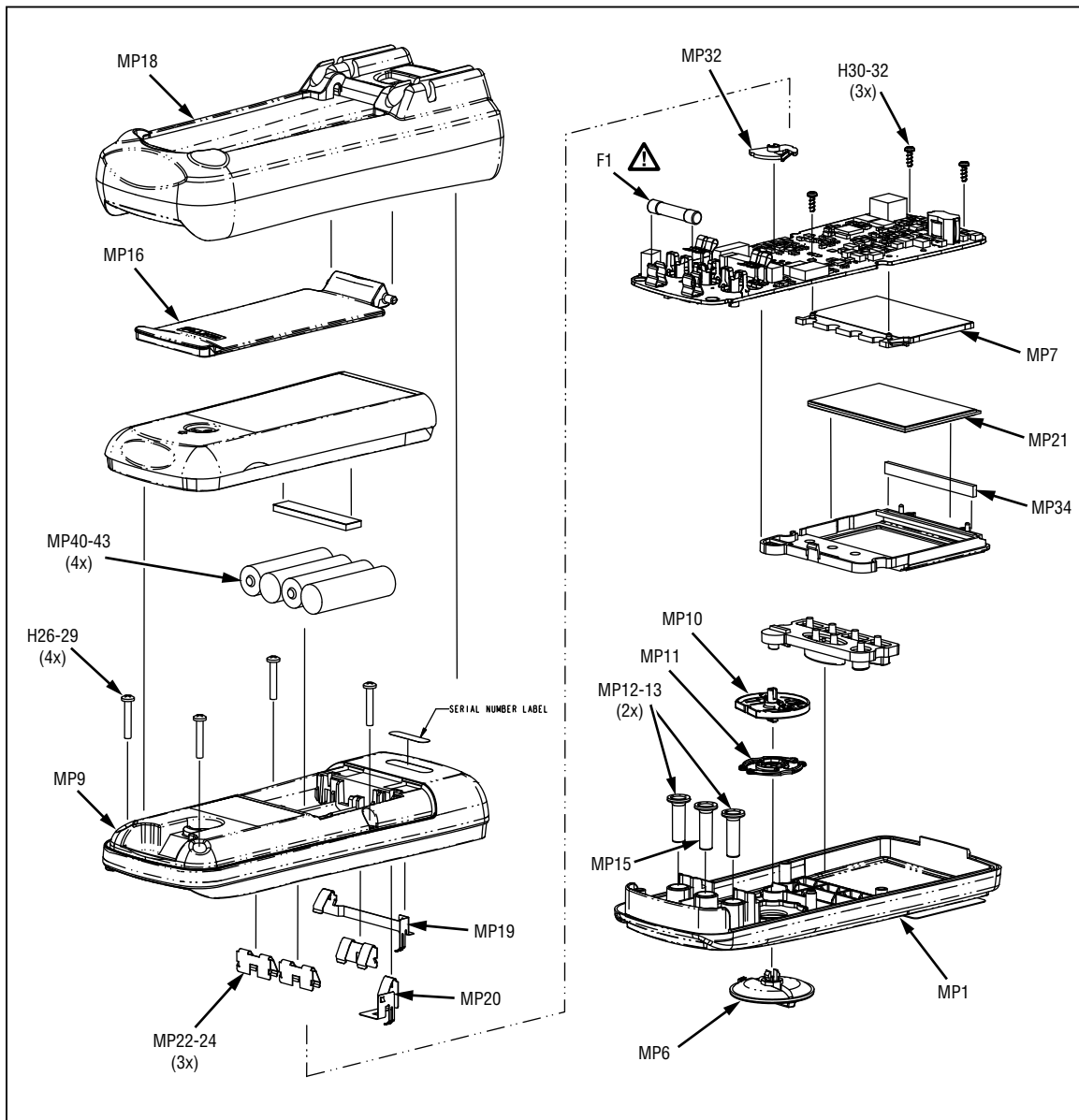

**Table 11. Generic150X Replacement Parts**

<b>Ref Des</b>	<b>Description</b>	<b>P/N</b>	<b>Qty</b>
MP4	102-406-003,PROBE CAP,GS-38 RED	1942029	1
MP6	FLUKE-15X7-8008,KNOB	2278007	1
MP7	FLUKE-15X7-8001,FLUKE-15X7-8001, BACKLIGHT	2168609	1
MP9	FLUKE-1508-8003-02,BOTTOM CASE	2388589	1
MP10	FLUKE-15X7-8009,HOUSING ASSY,RSOB	2278018	1
MP11	FLUKE-15X7-8010,DETENT SPRING	2278029	1
MP12-13	FLUKE-15X7-8011,INSULATOR,RECEPTACLE, RED	2278128	2
MP15	FLUKE-15X7-8011-01,INSULATOR,RECEPTACLE, BLACK	2278137	1
MP16	FLUKE-15X7-8012,TILT STAND	2278143	1
MP18	FLUKE-15X7-8014,HOLSTER	2278162	1
MP19	FLUKE-15X7-8016,BATTERY CONTACT,NEG	2281317	1
MP20	FLUKE-15X7-8017,BATTERY CONTACT,POS	2281321	1
MP21	LCD,TN,3.0V,TRANSFLECTIVE,1/4-DUTY,1/3-BIAS	2156884	1
MP22-24	FLUKE 89-4-8012 ,BATTERY CONTACT, DUAL	666435	3
MP40-43	BATTERY,PRIMARY,MNO2-ZN,1.5V,2.24AH,15A,LR6,ALKALINE,AA,14X50MM,BULK	376756	4
H26-29	SCREW,5-14,.750,PAN,PHILLIPS,STEEL,BLK CHROMATE,THREAD FORMING	832246	4
H30-32	SCREW,4-14,.312,PAN,PHILLIPS,STEEL,ZINC-CLEAR,THD FORM,#3 HEAD	642931	3
MP32	FLUKE 87-8004,CONTACT,PTF	822676	1
F1 	FUSE,315 MA,1000 V AC/DC,FAST,6.35 X 32 MM,BULK	2279339	1
MP44	FLUKE-165X-8008,PROBE,MULTIFUNCTIONAL	2000757	1
MP34	CONNECTOR,ELASTOMERIC,.01IN CTR,.218 IN HIGH,.090 IN THICK,2.43 IN LONG,BULK	2396462	1

**Table 12. 1508 Specific Parts**

<b>Ref Des</b>	<b>Description</b>	<b>P/N</b>	<b>Qty</b>
MP1	FLUKE-1508-8004-01,CASE TOP,PAD XFER	2282457	1
MP2	FLUKE-1508-8005-03,BRACKET,MASK,PAD XFER	2282504	1
MP3	FLUKE-1508-8018,KEYPAD	2388514	1
MP5	FLUKE-1508-8007-02,DOOR,ACCESS	2388550	1
MP46	FLK 19-8014,TEST LEAD SET	666602	1
MP47	ALLIGATOR CLIP,600/1000V,2MM JACK,RED	1670641	1
MP48	ALLIGATOR CLIP,600/1000V,2MM JACK,BLACK	1670652	1
MP36	1508 USERS MANUAL (Chinese and English)	2416024	1

**Table 13. 1507 Specific Parts**

<b>Ref Des</b>	<b>Description</b>	<b>P/N</b>	<b>Qty</b>
MP1	FLUKE-1507-8004-01,CASE TOP, PAD XFER	2282433	1
MP2	FLUKE-1507-8005-02,BRACKET,MASK,PAD XFER	2282491	1
MP3	FLUKE-1507-8018-01,KEYPAD	2388523	1
MP5	FLUKE-1507-8007-03,DOOR,ACCESS	2388561	1
MP46	TL224-4201,175-263-011 TEST LEADS RA2S	2070140	1
MP47	021-236-003,ALL.CLIP EX-LARGE RED IEC1010	1958654	1
MP48	021-236-001,ALL. CLIP EX-LARGE BLK IEC1010	1958646	1
MP49	PROBE,TEST,BANANA JACK,4MM TIP,RED W/CAP, 175-290-003	2099044	1
MP50	PROBE,PROBE,TEST,BANANA JACK,4MM TIP,BLACK W/CAP,175-290-001	2427138	1

**Table 14. 1503 Specific Parts**

<b>Ref Des</b>	<b>Description</b>	<b>P/N</b>	<b>Qty</b>
MP1	FLUKE-1503-8004-01,CASE TOP,PAD XFER	2282416	1
MP2	FLUKE-1503-8005-01,BRACKET,MASK,PAD XFER	2282484	1
MP3	FLUKE-1503-8018-02,KEYPAD	2388538	1
MP5	FLUKE-1503-8007-04,DOOR,ACCESS	2388577	1



