

BT510

Battery Analyzer

Users Manual

LIMITED WARRANTY AND LIMITATION OF LIABILITY

Each Fluke product is warranted to be free from defects in material and workmanship under normal use and service. The warranty period is three years and begins on the date of shipment. Parts, product repairs, and services are warranted for 90 days. This warranty extends only to the original buyer or end-user customer of a Fluke authorized reseller, and does not apply to fuses, disposable batteries, or to any product which, in Fluke's opinion, has been misused, altered, neglected, contaminated, or damaged by accident or abnormal conditions of operation or handling. Fluke warrants that software will operate substantially in accordance with its functional specifications for 90 days and that it has been properly recorded on non-defective media. Fluke does not warrant that software will be error free or operate without interruption.

Fluke authorized resellers shall extend this warranty on new and unused products to end-user customers only but have no authority to extend a greater or different warranty on behalf of Fluke. Warranty support is available only if product is purchased through a Fluke authorized sales outlet or Buyer has paid the applicable international price. Fluke reserves the right to invoice Buyer for importation costs of repair/replacement parts when product purchased in one country is submitted for repair in another country.

Fluke's warranty obligation is limited, at Fluke's option, to refund of the purchase price, free of charge repair, or replacement of a defective product which is returned to a Fluke authorized service center within the warranty period.

To obtain warranty service, contact your nearest Fluke authorized service center to obtain return authorization information, then send the product to that service center, with a description of the difficulty, postage and insurance prepaid (FOB Destination). Fluke assumes no risk for damage in transit. Following warranty repair, the product will be returned to Buyer, transportation prepaid (FOB Destination). If Fluke determines that failure was caused by neglect, misuse, contamination, alteration, accident, or abnormal condition of operation or handling, including overvoltage failures caused by use outside the product's specified rating, or normal wear and tear of mechanical components, Fluke will provide an estimate of repair costs and obtain authorization before commencing the work. Following repair, the product will be returned to the Buyer transportation prepaid and the Buyer will be billed for the repair and return transportation charges (FOB Shipping Point).

THIS WARRANTY IS BUYER'S SOLE AND EXCLUSIVE REMEDY AND IS IN LIEU OF ALL OTHER WARRANTIES, EXPRESS OR IMPLIED, INCLUDING BUT NOT LIMITED TO ANY IMPLIED WARRANTY OF MERCHANTABILITY OR FITNESS FOR A PARTICULAR PURPOSE. FLUKE SHALL NOT BE LIABLE FOR ANY SPECIAL, INDIRECT, INCIDENTAL OR CONSEQUENTIAL DAMAGES OR LOSSES, INCLUDING LOSS OF DATA, ARISING FROM ANY CAUSE OR THEORY.

Since some countries or states do not allow limitation of the term of an implied warranty, or exclusion or limitation of incidental or consequential damages, the limitations and exclusions of this warranty may not apply to every buyer. If any provision of this Warranty is held invalid or unenforceable by a court or other decision-maker of competent jurisdiction, such holding will not affect the validity or enforceability of any other provision.

Fluke Corporation
P.O. Box 9090
Everett, WA 98206-9090
U.S.A.

Fluke Europe B.V.
P.O. Box 1186
5602 BD Eindhoven
The Netherlands

Table of Contents

Chapter	Title	Page
1	Product Overview and Specifications	1-1
	Introduction.....	1-1
	Contact Fluke	1-1
	Product Overview	1-1
	Standard Equipment.....	1-3
	Safety Information	1-5
	Keys and I/O Terminals	1-8
	LCD Display	1-10
	Specifications	1-11
	General Specifications.....	1-11
	Accuracy Specifications.....	1-12
	Records Capacity	1-13
2	Setup	2-1
	Introduction.....	2-1
	Tilt Stand	2-1
	Belt Strap.....	2-2
	Adjust Display Contrast	2-3
	Set Language	2-3
	Set Date and Time	2-3
	Turn On/Off Beep	2-4
	AutoHold and AutoSave Modes	2-4
	Set Auto Power Off Time.....	2-5
	View Device Information.....	2-6
	Reset to Factory Mode	2-6
	View Memory Usage Information	2-6
3	Use the Product.....	3-1
	Introduction.....	3-1
	Switch Between Meter Mode and Sequence Mode.....	3-1
	Use a Profile in Sequence Mode	3-3
	Manage Profiles.....	3-3
	Create a Profile.....	3-4

Edit a Profile	3-5
Edit a Profile During Creation	3-5
Modify a Profile During Measurement	3-5
Load a Profile	3-5
Load a Profile When Switched to Sequence Mode	3-6
Load a Profile During Measurement in Sequence Mode	3-6
Make Measurements	3-7
Test Battery Internal Resistance and Voltage or Strap Resistance...	3-7
Battery Test Probes	3-8
View Test Readings on the Screen	3-9
Measure Strap resistance in sequence mode	3-10
Set Measurement Range.....	3-10
Save Battery Test Readings.....	3-10
Erase Test Readings	3-10
Activate Low-Pass Filter for Resistance Measurement	3-11
Set Measurement Thresholds	3-11
How the Thresholds Work	3-12
Measure Discharge Voltage	3-13
Make Measurements	3-13
Typical Display	3-13
Measure DC Voltage	3-14
Set Measurement Range.....	3-14
Save DC Voltage Readings.....	3-14
Measure AC Voltage	3-15
Measurement Range	3-15
Save AC Voltage Readings	3-15
Measure Ripple Voltage	3-16
Set Measurement Range.....	3-16
Save Ripple Voltage Readings.....	3-16
Measure Voltage with TL175.....	3-17
4 View Memory	4-1
Introduction.....	4-1
View Data Saved in Meter Mode	4-1
Delete Data Saved in Meter Mode	4-1
View Profiles Saved in Sequence Mode	4-2
Delete Profiles Saved in Sequence Mode	4-3
5 Connection to PC	5-1
Introduction.....	5-1
Connect the Product to PC.....	5-1
6 Maintenance.....	6-1
Introduction.....	6-1
Install or Replace the Battery Pack	6-3
Replace the Fuse	6-4
Replace the Probe Tips	6-5
Zero Calibration.....	6-6
Clean the Product.....	6-7
Charge the Battery	6-7
Parts and Accessories.....	6-9

List of Tables

Table	Title	Page
1-1.	Standard Equipment.....	1-3
1-2.	Symbols.....	1-7
1-3.	Keys	1-8
1-4.	Typical Elements on the LCD Display	1-10
6-1.	Parts and Accessories.....	6-9

List of Figures

Figure	Title	Page
1-1.	Standard Equipment.....	1-4
1-2.	I/O Terminals.....	1-9
2-1.	Tilt Stand.	2-1
2-2.	The Belt Strap	2-2
3-1.	Test Battery Internal Resistance and Voltage or Strap Resistance	3-7
3-2.	Connect Test Probe to Battery	3-8
3-3.	Measure DC Voltage	3-14
3-4.	Measure AC Voltage	3-15
3-5.	Measure DC Voltage with TL175	3-17
5-1.	Connection to PC	5-1
6-1.	Install or Replace a Battery Pack	6-3
6-2.	Replace the Fuse	6-4
6-3.	Replace the Probe Tips.....	6-5
6-4.	Zero Calibration Setup	6-6
6-5.	Charge the Battery	6-8

Chapter 1

Product Overview and Specifications

Introduction

This chapter supplies information about the Product, safety information, contact information, and specifications.

Contact Fluke

To contact Fluke, call one of the following telephone numbers:

- Technical Support USA: 1-800-44-FLUKE (1-800-443-5853)
- Calibration/Repair USA: 1-888-99-FLUKE (1-888-993-5853)
- Canada: 1-800-36-FLUKE (1-800-363-5853)
- Europe: +31 402-675-200
- China: +86-400-810-3435
- Japan: +81-3-6714-3114
- Singapore: +65-6799-5566
- Anywhere in the world: +1-425-446-5500

Or, visit Fluke's website at www.fluke.com.

To register your product, visit <http://register.fluke.com>.

To view, print, or download the latest manual supplement, visit <http://en-us.fluke.com/support/manuals>.

Product Overview

The Fluke BT510 Battery Analyzer (the Product) is a multifunctional meter designed for the test and measurement of a stationary battery system. The Product can measure the battery internal resistance and voltages. These measurements can be used to determine the overall condition of the system. It can also measure electrical parameters for battery system maintenance, including dc voltage up to 600 V, ac voltage up to 600 V, and ripple voltage.

Features of the Product include:

- **CAT III 600 V Safety Rated** – The Product can measure a maximum of 600 V ac in a Category III environment.
- **Battery Internal Resistance** – Via the Kelvin connections, the Product measures the internal resistance. An increase in the internal resistance from a known baseline indicates the battery is deteriorating. The testing takes less than 3 seconds.

- **Battery Voltage** – During the internal resistance test, the Product also measures the voltage of the battery under test.
- **Discharge Volts** – The Discharge mode collects the voltage of each battery several times at a certain interval during a discharge or load test. Users can calculate the time a battery takes to drop to the cut-off voltage and use this time to determine the capacity loss of this battery.
- **Ripple Voltage Test** – Measures the unwanted residual ac component of the rectified voltage in dc charging and inverter circuits. Allows users to test ac components in dc charging circuits and find one of the root causes of battery deterioration.
- **Meter and Sequence Modes** – The Meter mode is used for a quick test or troubleshooting. In this mode you can save and read the readings in a time sequence. The Sequence mode is for maintenance tasks with multiple power systems and battery strings. Before a task starts, users can configure a profile for the task for data management and report generation.
- **Threshold and Warning** – Users can configure a maximum of 10 sets of thresholds and receive a Pass/Fail/Warning indication after each measurement.
- **AutoHold** – When AutoHold is turned on, the Product freezes the reading when it remains stable for 1 second. The frozen reading is released when a new measurement starts.
- **AutoSave** – When the AutoSave mode is on, measured values are saved to the internal memory of the Product automatically after AutoHold.
- **Fluke Battery Analyzer Software** – Easily import data from the Product to a PC. The measurement data and battery profile information is stored and archived with the Analyze Software and can be used for comparison and trend analysis. All measurement data, battery profile and analysis information can be used to easily generate reports.

Standard Equipment

Items listed in Table 1-1 are included with the Product. Figure 1-1 shows the items.

Table 1-1. Standard Equipment

Item No.	Description	Quantity
①	Mainframe	1
②	BTL10, Basic Test Lead	1
③	TL175, TwistGuard™ Test Leads	1
④	BTL_A, Voltage/Current Probe Adapter	1
⑤	BP500, 7.4 V 3000 mAh Lithium-ion battery	1
⑥	BC500, 18 V dc charger	1
⑦	Power cord	1
⑧	Standard mini-b USB cable (cable length: 1 m)	1
⑨	BCR, Zero calibration board	1
⑩	Shoulder strap	1
⑪	Belt strap	1
⑫	Magnetic plate	1
⑬	C500S Soft carrying case, small	1
⑭	Spare fuse	2
--	Safety Sheet, not shown	1
--	Warranty card, not shown	1
--	Quick Reference Guide, not shown	1
--	FlukeView® Battery (CD) containing USB driver and manuals in all languages, not shown	1



Figure 1-1. Standard Equipment

hpo056.eps

Safety Information

A **Warning** identifies conditions and procedures that are dangerous to the user. A **Caution** identifies conditions and procedures that can cause damage to the Product or the equipment under test.

Warning











To prevent possible electrical shock, fire, or personal injury:

- Carefully read all instructions.
- Read all safety information before you use the Product.
- Use the Product only as specified, or the protection supplied by the Product can be compromised.
- Do not use the Product around explosive gas, vapor, or in damp or wet environments.
- Do not use the Product if it is damaged.
- Do not use the Product if it operates incorrectly.
- Do not apply more than the rated voltage, between the terminals or between each terminal and earth ground.
- Do not touch voltages > 30 V ac rms, 42 V ac peak, or 60 V dc.
- Do not exceed the Measurement Category (CAT) rating of the lowest rated individual component of a Product, probe, or accessory.
- Do not use the HOLD function to measure unknown potentials. When HOLD is turned on, the display does not change when a different potential is measured.
- Use extreme caution when working around bare conductors or bus bars. Contact with the conductor could result in electric shock.
- Do not use test leads if they are damaged. Examine the test leads for damaged insulation or exposed metal, or if the wear indicator shows. Check test lead continuity.
- Connect the common test lead before the live test lead and remove the live test lead before the common test lead.
- Avoid simultaneous contact with battery and frame racks or hardware that may be grounded.
- Comply with local and national safety codes. Use personal protective equipment (approved rubber gloves, face protection, and flame-resistant clothes) to prevent shock and arc blast injury where hazardous live conductors are exposed.
- Examine the case before you use the Product. Look for cracks or missing plastic. Carefully look at the insulation around the terminals.

- **Use only correct measurement category (CAT), voltage, and amperage rated probes, test leads, and adapters for the measurement.**
- **Measure a known voltage first to make sure that the Product operates correctly.**
- **Limit operation to the specified measurement category, voltage, or amperage ratings.**
- **Keep fingers behind the finger guards on the probes.**
- **Remove all probes, test leads, and accessories before the battery door is opened.**
- **Use the correct terminals, function, and range for measurements.**
- **Use only test leads and adapters supplied with the Product.**
- **Install the CAT III protective cap of test lead when you use the product in CAT III environment. The CAT III protective cap decreases the exposed probe metal to < 4 mm.**
- **Do not operate the Product with covers removed or the case open. Hazardous voltage exposure is possible.**

See Table 1-2 for a list of symbols used in this manual and on the Product.

Table 1-2. Symbols

Symbol	Description	Symbol	Description
	WARNING. RISK OF DANGER. See manual.	~	AC (Alternating Current)
	WARNING. HAZARDOUS VOLTAGE. Risk of electric shock.		DC (Direct Current)
	Earth		Fuse
CAT II	Measurement Category II is applicable to test and measuring circuits connected directly to utilization points (socket outlets and similar points) of the low-voltage MAINS installation.	CAT III	Measurement Category III is applicable to test and measuring circuits connected to the distribution part of the building's low-voltage MAINS installation.
CAT IV	Measurement Category IV is applicable to test and measuring circuits connected at the source of the building's low-voltage MAINS installation.		Conforms to relevant South Korean EMC Standards.
	Certified by TÜV SÜD Product Service.		Certified by CSA Group to North American safety standards.
CE	Conforms to European Union directives.		Conforms to relevant Australian EMC Standards.
	This product complies with the WEEE Directive marking requirements. The affixed label indicates that you must not discard this electrical/electronic product in domestic household waste. Product Category: With reference to the equipment types in the WEEE Directive Annex I, this product is classed as category 9 "Monitoring and Control Instrumentation" product. Do not dispose of this product as unsorted municipal waste.		

Keys and I/O Terminals

Table 1-3 identifies and describes the keys.

Table 1-3. Keys

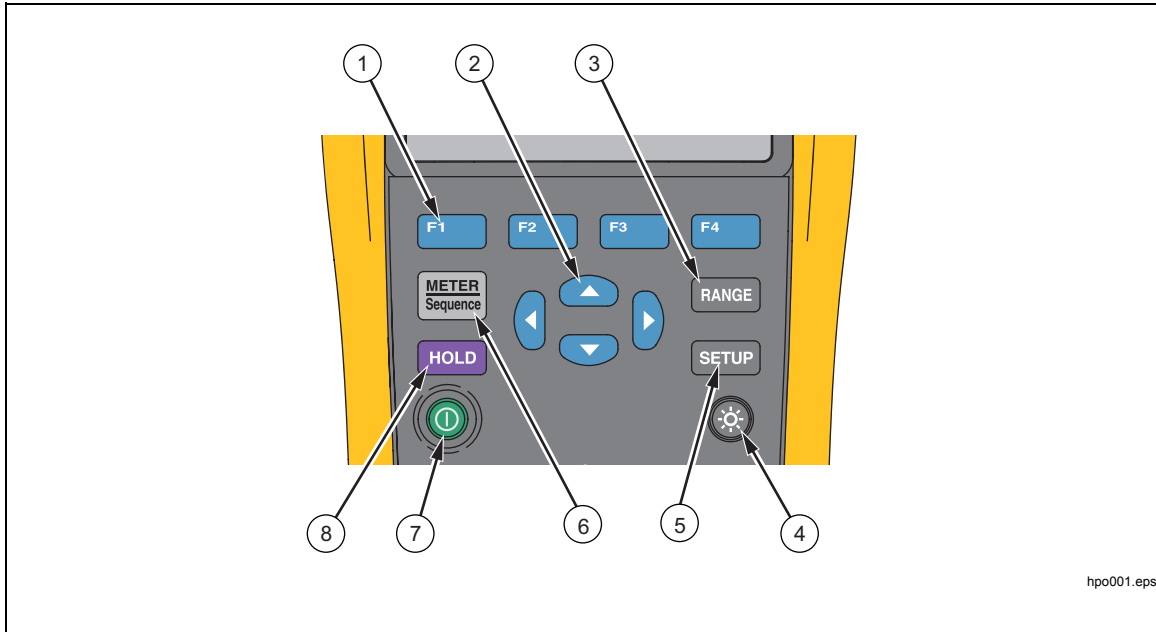

hpo001.eps

Item	Key	Function
①		Softkeys that work flexibly for various functions on the display.
②		Selects an item in a menu and scrolls through information.
③		Switches between manual ranging and auto ranging. Cycles through all ranges in manual ranging mode.
④		Turns on or turns off backlight.
⑤		Opens the Setup menu for configurations such as contrast, language, date/time, and power off time.
⑥		Switches between Meter and Sequence measurement modes. For details, see Chapter 3. Switches between Meter and Sequence memories. For details, see Chapter 5.
⑦		Turns on or turns off the Product.
⑧		Freezes the current reading on the display and allows the display reading to be saved.

Figure 1-2 shows the terminals of the Product.

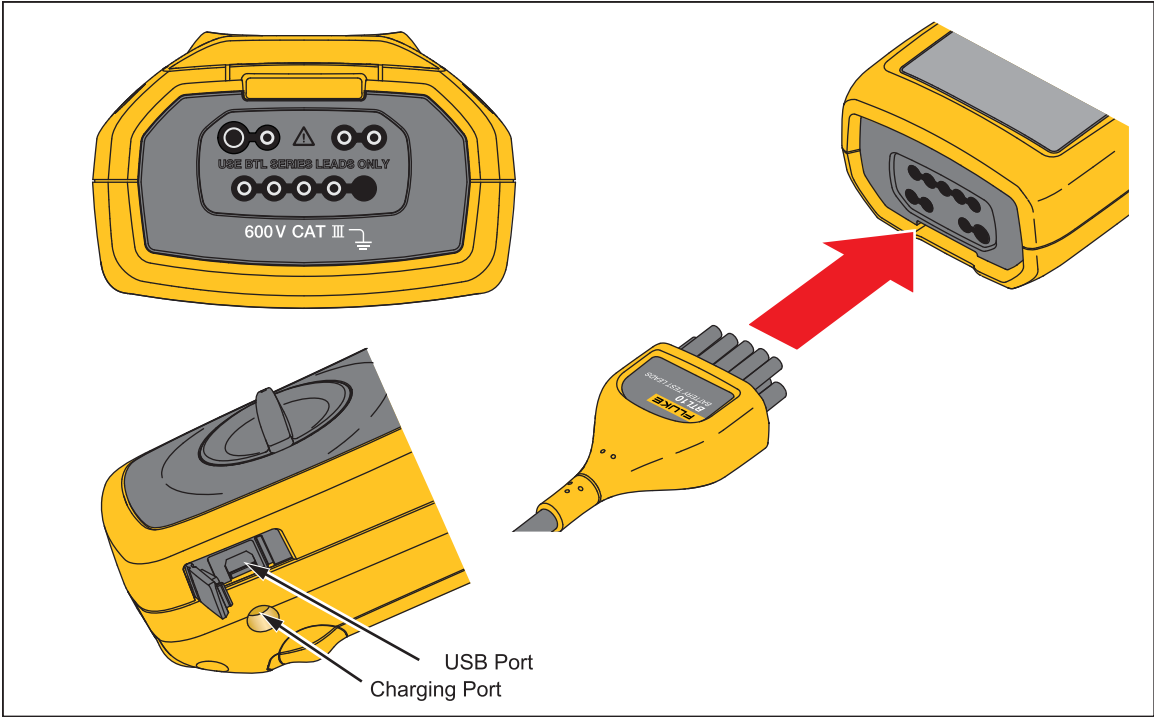

Figure 1-2. I/O Terminals

hpo002.eps

LCD Display

The Product has an LCD display that shows different elements for each measurement function. Table 1-4 describes the typical elements for battery internal resistance measurement in Sequence mode.

Table 1-4. Typical Elements on the LCD Display

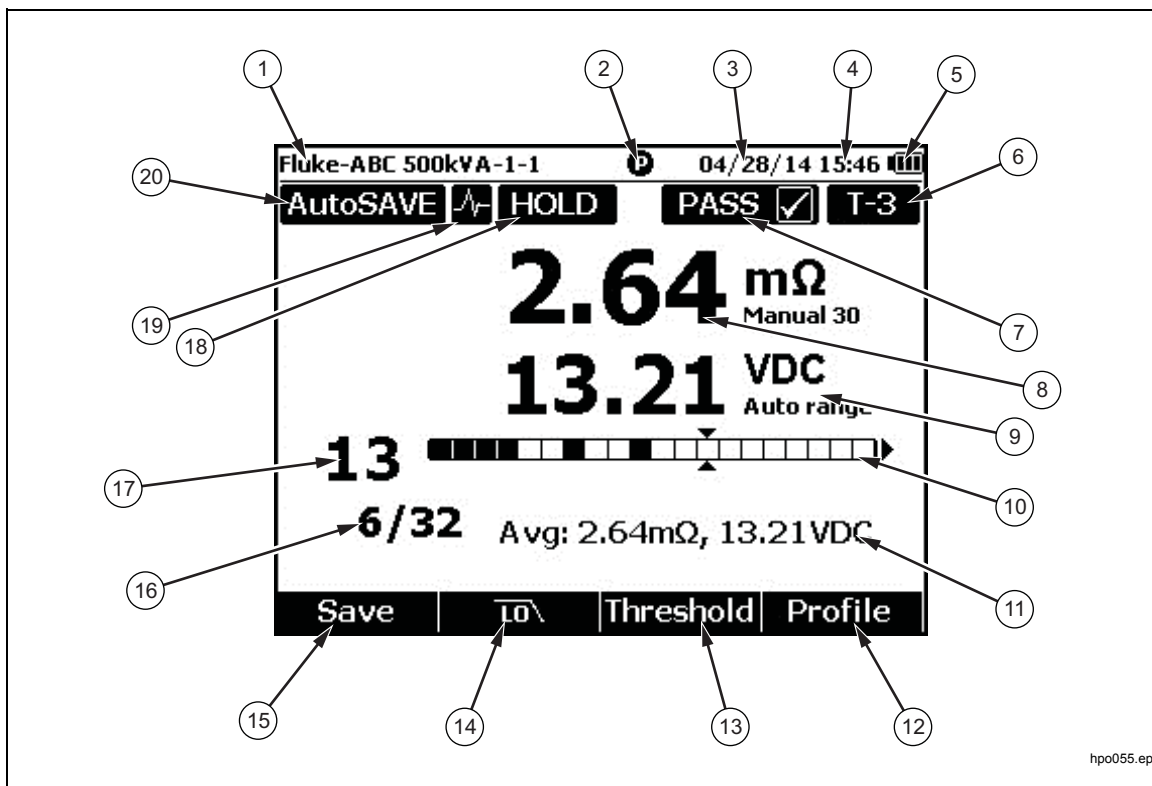

hpo055.eps

Item	Description	Item	Description
①	Profile name	⑪	Average readings
②	Probe connection status. A full circle means connected; an empty circle means not connected	⑫	Softkey F4 – Profile
③	Current date	⑬	Softkey F3 – Threshold
④	Current time	⑭	Softkey F2 – Low Pass Filter
⑤	Battery usage	⑮	Softkey F1 – Save (save current reading)
⑥	Threshold indication	⑯	Tested batteries VS Total number of batteries in a string
⑦	Test result (PASS, WARN, or FAIL)	⑰	Cursor position
⑧	Reading of battery internal resistance	⑱	At least one “data hold” succeeded (manual or auto)
⑨	Voltage reading	⑲	AutoHold function enabled
⑩	Progress bar (Sequence mode only)	⑳	AutoSave function enabled

Specifications

General Specifications

⚠ Fuse Protection for Resistance	0.44 A (44/100 A, 440 mA), 1000 V FAST Fuse, Fluke specified part only
Power Supply	
Battery power	BP500 smart battery pack: double cell lithium-ion, 7.4 V, 3000 mAh
Battery life	>8 hours in continuous full-load operation
Battery charging time	≤4 hours
Power adapter output voltage	Use only BC500 battery charger: 18 V, 840 mA
Line power	100 V ac to 240 V ac adapter with country specific plug
Frequency	50 Hz to 60 Hz
Temperature	
Operating	0 °C to 40 °C
Storage	-20 °C to 50 °C
Lithium-ion battery charging	0 °C to 40 °C
Relative Humidity (non-condensing, 10 °C)	
Operating	≤80 % at 10 °C to 30 °C ≤75 % at 30 °C to 40 °C
Altitude	
Operating	2,000 m
Storage	12,000 m
Temperature Coefficient	0.1 x (specified accuracy) /°C (<18 °C or >28 °C)
Size	58 x 103 x 220 (mm)
Weight	850 g
Memory	
Data/Setup flash memory	4 MB
Real-Time Clock	Time and date stamp for measurement. The RTC works >50 days without battery.
IP Rating	IEC 60529: IP 40
Safety	IEC 61010-1, IEC 61010-2-030, IEC 61010-031, Pollution Degree 2 600 V CAT III; Derated to CAT II with CAT II probe cap installed
EMI, RFI, EMC, RF	EC 61326-1: Portable Electromagnetic Environment; IEC 61326-2-2 CISPR 11: Group 1, Class A <i>Group 1: Equipment has intentionally generated and/or uses conductively-coupled radio frequency energy that is necessary for the internal function of the equipment itself.</i> <i>Class A: Equipment is suitable for use in all establishments other than domestic and those directly connected to a low-voltage power supply network that supplies buildings used for domestic purposes.</i> EN 300 328, EN 301 489-1, EN 301 489-17, FCC Part 15 Subpart C Sections 15.207, 15.209, 15.249 CONTAINS FCC IDs: T68-FWCS, XDULE40-S2 IC: 6627A-FWCS, 8456A-LE4S2 (For more information, go to www.fluke.com and search for "Radio Frequency Data for Class A".)
Electromagnetic Compatibility	Applies to use in Korea only. Class A Equipment (Industrial Broadcasting & Communication Equipment) ^[1]

[1] This product meets requirements for industrial (Class A) electromagnetic wave equipment and seller or user should take notice of it. This equipment is intended for use in business environments and is not to be used in homes.

Accuracy Specifications

Accuracy is specified for a period of one year after calibration, at 18 °C to 28 °C (64 °F to 82 °F), with relative humidity to 80 %. Accuracy specifications are given as: \pm ([% of reading] + [number of least significant digits]). Accuracy specification assumes ambient temperature stable ± 1 °C.

Function	Range	Resolution	Accuracy
Battery Internal Resistance ^[1]	3 mΩ	0.001 mΩ	1 % + 8
	30 mΩ	0.01 mΩ	0.8 % + 6
	300 mΩ	0.1 mΩ	0.8 % + 6
	3000 mΩ	1 mΩ	0.8 % + 6
V dc	6 V	0.001 V	0.09 % + 5
	60 V	0.01 V	
	600 V	0.1 V	
V ac (45 Hz to 500 Hz with low-pass filter)	600 V	0.1 V	2 % + 10
Frequency (Display with V ac) Trigger level: ≥ 10 mV @V ac;	45 Hz to 500 Hz	0.1 Hz	0.5 % + 8
AC Voltage Ripple (20 kHz max)	600 mV	0.1 mV	3 % + 20
	6000 mV	1 mV	3 % + 10
[1] The measurement is based on ac injection method. The injected source signal is <100 mA, 1 kHz.			

Records Capacity

Function	Meter Mode	Sequence
Battery Internal Resistance	Saved by test sequence with time stamp, up to 999 records	Up to 450 records in one profile
Battery Voltage	Display and save with battery internal resistance, up to 999 records	Display and save with battery internal resistance, up to 450 records in one profile
Discharge Voltage	Not available	Support up to 8 rounds for up to 450 batteries in one profile
V dc	Up to 999 records	Up to 20 records in one profile
V ac	Up to 999 records	Display and save with V ac, up to 20 records in one profile
Hz	Display and save with V ac, up to 999 records	Display and save with V ac, up to 20 records in one profile
AC Voltage Ripple	Up to 999 records	Up to 20 records in one profile

Chapter 2 Setup

Introduction

This chapter describes how to set up the Product.

Tilt Stand

The Product has a tilt stand that lets you see the screen at an angle when placed on a flat surface. See Figure 2-1.

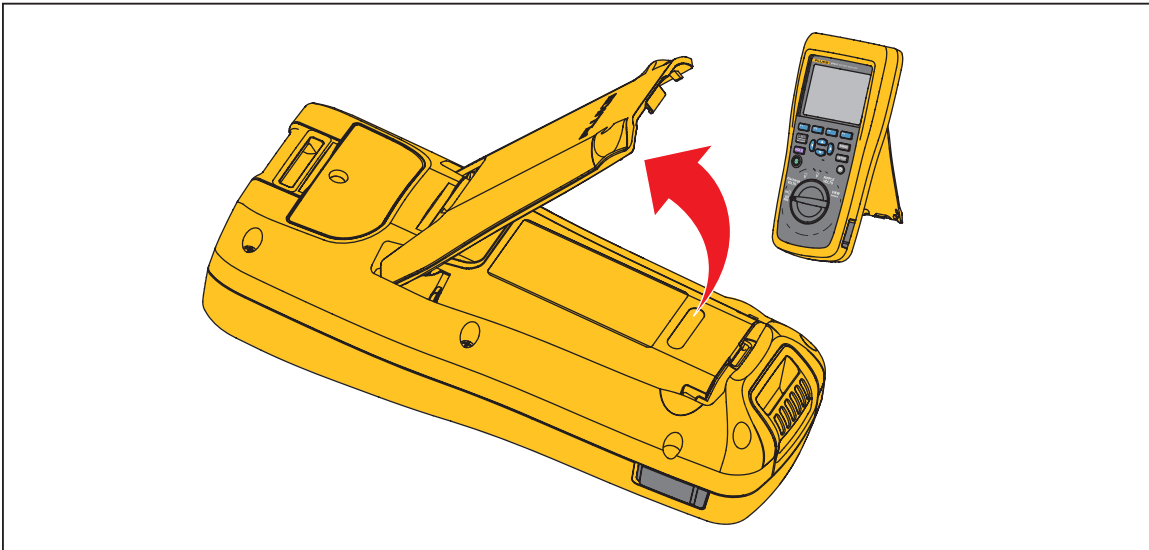

Figure 2-1. Tilt Stand

hpo007.eps

Belt Strap

Figure 2-2 shows how to use the belt strap of the Product.

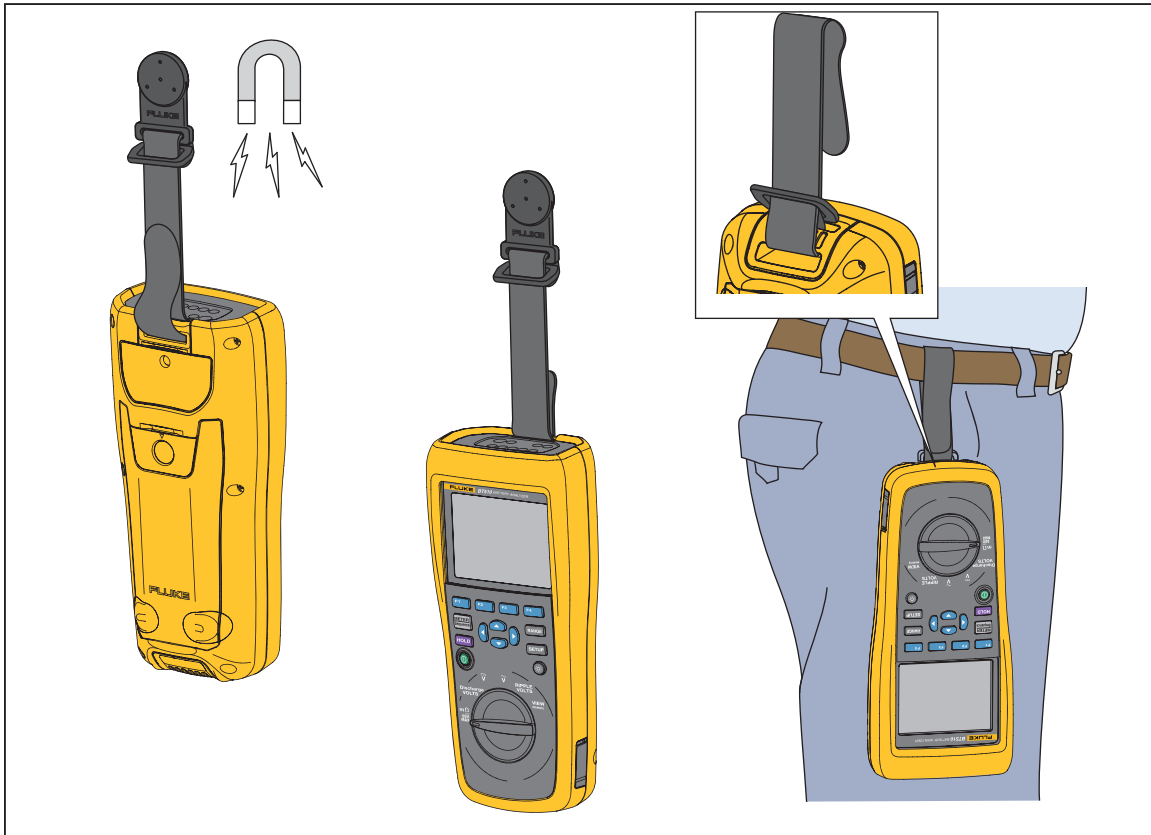

Figure 2-2. The Belt Strap

hpo031.eps

Adjust Display Contrast

To adjust the display contrast:

1. Push **SETUP** to open the Setup menu.
Contrast is already highlighted.
2. Push the **–** softkey to lighten contrast, or push the **+** softkey to darken contrast.

Note

If – is pushed too far, the display is blank.

3. Push the **Back** softkey to return to normal operation.

Set Language

These languages are available on the Product display:

- English
- German
- French
- Italian
- Dutch
- Portuguese
- Russian
- Spanish
- Turkish
- Simplified Chinese
- Korean

The default display language is English.

To select another language:





1. Push **SETUP** to open the Setup menu.
2. Use **▼** to move the menu selector to highlight **Language/English**.
3. Push the **Select** softkey to open the Language menu.
4. Use **▼** and **▲** to highlight the desired language, and then push the **Confirm** softkey.
5. Push the **Back** softkey to return to normal operation.

Set Date and Time





The internal clock of the Product is used on the display and for time-stamping recorded measurements.

To change the date and time:

1. Push **SETUP** to open the Setup menu.
2. Use **▼** and **▲** to highlight **General** and push the **Select** softkey.
Date/time is selected by default.
3. Push the **Adjust** softkey to open the Date/time – Adjust screen.



4. Use  and  to highlight the field to be edited. Use  and  to increase or decrease value.
5. When the correct date and time is set, push the **OK** softkey.
6. Push the **Back** softkey to return to normal operation.

To change the date format:

1. Push **SETUP** to open the Setup menu.
2. Use  and  to highlight **General** and push the **Select** softkey.
Date/time is selected by default.
3. Push the **Format** softkey to open the Date format menu.
4. Use  and  to highlight the correct date format.
5. Push the **Confirm** softkey.
6. Push the **Back** softkey to return to normal operation.

Turn On/Off Beep

To turn on or turn off beep:

1. Push **SETUP** to open the Setup menu.
2. Use  to highlight **Beep**, and push the **Select** softkey.
3. Use  and  to highlight **Off** or **On**, and push the **Confirm** softkey.
4. Push the **Back** softkey to return to normal operation.

AutoHold and AutoSave Modes

Note

AutoHold and AutoSave are available only for the Battery Internal Resistance and Discharge functions.

When AutoHold is turned on, the "heart beat" icon shows on the display. The Product will hold the reading when it remains stable for 1 second. After a successful AutoHold, the **HOLD** icon shows on the display. The auto-held reading will not be released even after the user disconnects the test leads from the test object.

In AutoSave mode, the **AutoSave** icon shows on the display. The auto-held reading is automatically saved to the internal memory.

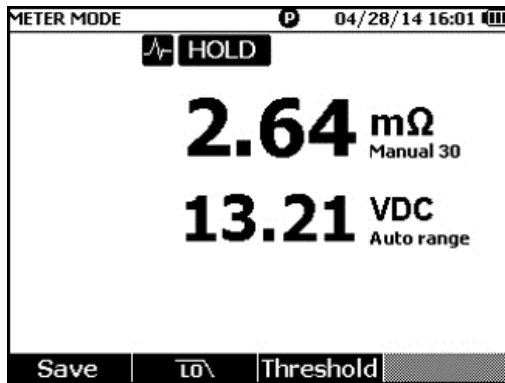

hpo049.jpg

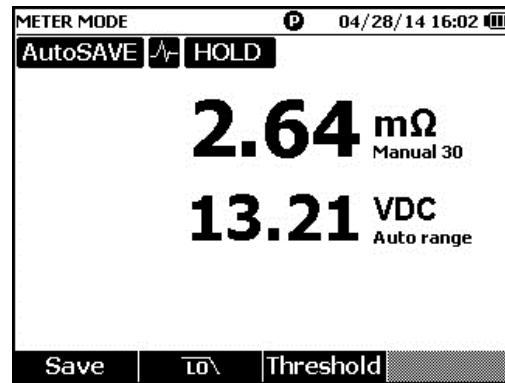

hpo048.jpg

⚠⚠ Warning

To prevent possible electrical shock, fire, or personal injury, do not use the HOLD function to measure unknown potentials. When HOLD is turned on, the display does not change when a different potential is measured.

To set AutoHold and AutoSave mode:

1. Push **SETUP** to open the Setup menu.
2. Use **▼** and **▲** to highlight **Auto mode**.
3. Push the **Select** softkey to open the Auto mode menu.
4. Use **▼** and **▲** to highlight **Disable**, **HOLD**, or **HOLD+SAVE**.
5. Push the **Confirm** softkey.
6. Push the **Back** softkey to return to normal operation.

Set Auto Power Off Time

The Product has an auto power off function to save power. Use the Auto Power Off Time function to save power. The options are, enable or disable auto power off and set the time between the last operation and auto power off.





To set the time for auto-power off:

1. Push **SETUP** to open the Setup menu.
2. Use **▼** and **▲** to highlight **General** and push the **Select** softkey.
3. Use **▼** and **▲** to highlight **Power off**, and push the **Select** softkey.
4. Use **▼** and **▲** to highlight **5 Minutes**, **15 Minutes**, **30 Minutes**, or **Never**.
5. Push the **Confirm** softkey.
6. Push the **Back** softkey to return to the Setup screen.

View Device Information





The Product provides the following device information: model number, serial number, version, analog board version, and calibration date.

To view the device information:

1. Push **SETUP** to open the Setup menu.
2. Use  and  to highlight **General**, and push the **Select** softkey.
3. Use  and  to highlight **Device info.**, and push **View** softkey.
The Device info... screen shows.
4. Push the **Back** softkey to return to the Setup screen.

Reset to Factory Mode

To reset the Product to factory mode:



1. Push **SETUP** to open the Setup menu.
2. Use  and  to highlight **General**, and push the **Select** softkey.
3. Use  and  to highlight **Factory mode**, and push the **Reset** softkey.
4. Push the **Confirm** softkey to reset the Product to factory mode.

Note

If the Product is reset to factory mode, all current measurement data will be lost.

View Memory Usage Information

To view memory usage information:

1. Push **SETUP** to open the Setup menu.
2. Use  and  to highlight **Memory info.**, and push the **Select** softkey.
The screen shows the memory usage information in Meter mode and Sequence mode.
3. Push the **Back** softkey to return to the Setup screen.

Chapter 3

Use the Product

Introduction

This chapter provides information about how to use the Product. The Product provides two modes for different measurement purposes: Meter mode and Sequence mode.

Meter mode lets you perform easy and fast measurements and save the measurement readings and timestamp to the Product memory. In this mode, the Product measures battery internal resistance and voltage, dc voltage, ac voltage, and ripple voltage.

Sequence mode is designed for battery maintenance personnel who work between multiple test sites. In this mode, you can create a profile for each battery string to be tested. The profile specifies information such as user-defined test site, device type, serial number, battery quantity, and battery model. During the test, all test data, including battery resistance, voltage, and ripple voltage is stored in the profile. After a battery string test is completed, you can create a new profile for the next battery string or test site. You can also recall or delete the test data in a history profile.

With the integrated profile management and the analysis software on the PC, you can analyze the trend of maintenance data and create reports in an efficient way. For example, you can create a comprehensive test and maintenance report for a test site or analyze the resistance changes of one battery string over time.

Switch Between Meter Mode and Sequence Mode

Each time you power on the Product, it is in Meter mode by default. **METER MODE** shows on the upper-left corner of the display.

To switch to Sequence mode:

1. Push .

The Enter SEQUENCE mode? screen shows.

2. Push the **Continue**, **New**, or **Load** softkey and make other required selections to enter the measurement screen of Sequence mode.

Note

When you first enter SEQUENCE mode, push the New softkey to create a new profile.

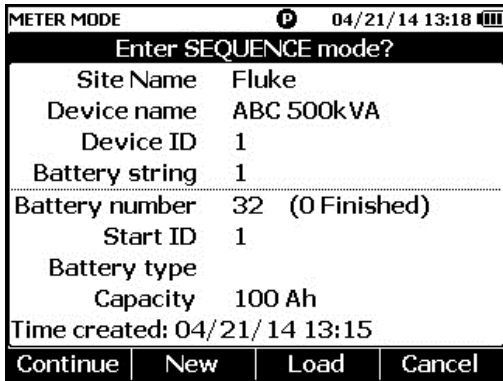

hpo001.jpg

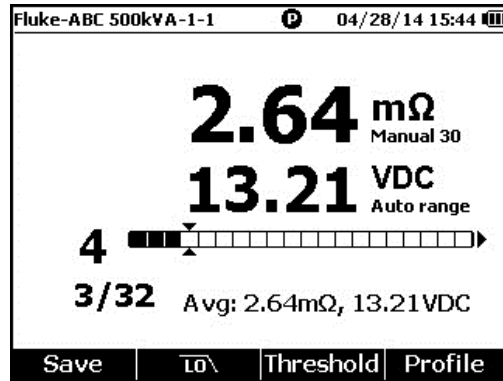

hpo002.jpg

To switch back to Meter mode:

1. Push .
2. When the Back to METER mode? screen shows, push the **Continue** softkey.

The measurement screen of Meter mode shows.

Note

All measurements taken in Sequence mode are saved to the memory.

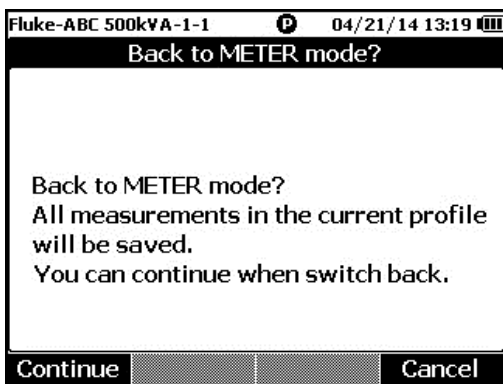

hpo003.jpg

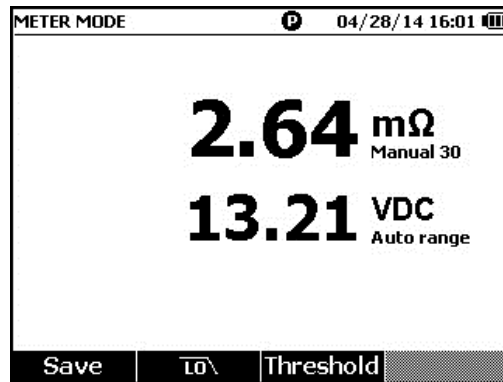

hpo005.jpg

Use a Profile in Sequence Mode

In Sequence mode, the Product lets you manage, categorize, and analyze data by profiles. The figure below shows a typical profile.

Fluke-ABC 500kVA-1-1		04/28/14 15:55
Profile info		
Site Name	Fluke	
Device name	ABC 500kVA	
Device ID	1	
Battery string	1	
Battery number	32 (12 Finished)	
Start ID	1	
Battery type		
Capacity	100 Ah	
Time created: 04/28/14 15:43		
Modify	New	Load
Cancel		

hpo006.jpg

Manage Profiles

Each Product stores up to 100 profiles. A profile describes the battery maintenance environment in a tree view.

For example:

- Site Name: Fluke
- Device name: ABC 500kVA
- Device ID: 1
- Battery string: 1
- Start ID: 1

In this case the upper-left corner shows the profile name **Fluke-ABC 500KVA-1-1**. The PC software uses the same structure to categorize the profile.

Fluke recommends that you always use the same profile name for one battery string for better analysis. The profiles are distinguished by their timestamps.

Create a Profile

The Product provides these options to create a profile:

- **Create by default:** Uses system default data to create each profile.
- **Copy from template:** Copies data from an existing template.
- **String+1:** Copies data from the previous profile and increases 1 to the value of Battery string.

Note

The “Copy from template” option is available only after templates are downloaded the from PC software.

To create a profile in Sequence mode:

1. On the measurement screen of Sequence mode, push the **Profile** softkey.
The Profile info menu shows on the display.
2. Push the **New** softkey. The Select the Way to Create menu shows on the display.

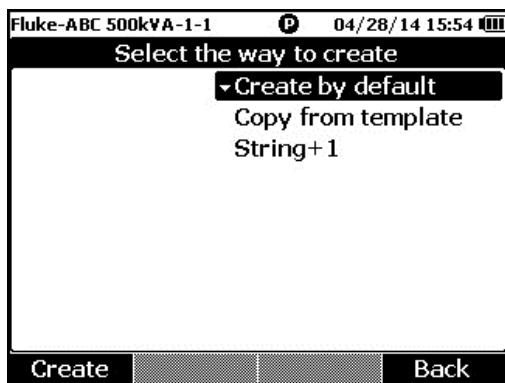

hpo004.jpg

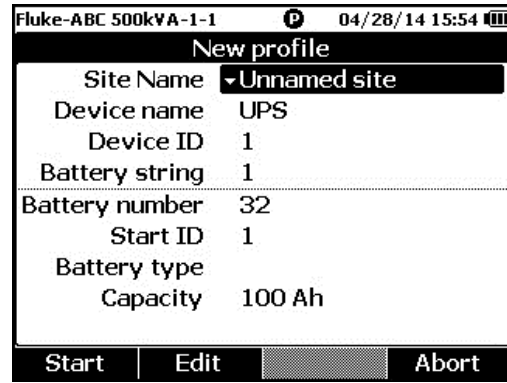

hpo012.jpg

3. Use **▲** and **▼** to select **Create by default**, **Copy from template**, or **String+1**.
4. Push the **Create** softkey.
The New Profile menu shows on the display.
5. When necessary, push the **Edit** softkey, and then use the arrow keys and softkeys to edit the field values.
6. Push the **Done** softkey to exit the edit status.
7. Push the **Start** softkey to enter the measurement screen.

Note



- *When the same battery string is tested periodically, Fluke recommends that you use the same profile. In this way, test data can be archived and the data trend can be viewed easier.*
- *After test of one battery string is completed in a system, the String+1 function lets you easily switch to the next battery string without the need of repeated data input.*

Edit a Profile

In Sequence mode, profiles can be edited during creation or during measurement.

Edit a Profile During Creation

To edit a profile during creation:

1. On the New Profile menu, use  and  to highlight a data field to be edited.
2. Edit the data value.
 - a. For **Device ID** and **Battery string**, use the **-** and **+** softkeys to change the value.
 - b. For other data fields, push the **Edit** softkey and use the arrow keys to change the data value. Use the **Select** softkey for each selection and the **Done** softkey to complete a data field.
3. Push the **Start** softkey to confirm the change and enter the measurement screen.

Modify a Profile During Measurement

To edit a profile during measurement:

1. Push the **Profile** softkey.



The Profile info screen shows.

Note

Once a profile is created, the battery number or the Start ID cannot be changed. Other data values are editable.

2. Push the **Modify** softkey.

The Edit profile screen shows.

3. Use  and  to highlight the data field to be edited.
4. Use the method in the “Edit a profile during creation” section to edit the profile.

Load a Profile



In Sequence mode, the Product can load a previously saved profile when it is switched to Sequence mode or during measurements in Sequence mode. This method can be used to continue an unfinished profile.

Note

All data in the current profile will be automatically saved when a previous profile is loaded.



Load a Profile When Switched to Sequence Mode

To load a profile when switched to Sequence mode:

1. On the Enter SEQUENCE mode? screen, push the **Load** softkey.
The Load profile screen shows the list of history profiles in the Product memory.
2. Use  and  to highlight the number of the profile to be loaded.
3. Push the **Load** softkey.
Configurations of the selected profile show on the display.
4. Push the **Continue** softkey to confirm loading the selected profile.
Name of the loaded profile shows on the upper-left corner of the display.

Load a Profile During Measurement in Sequence Mode

To load a profile during measurements in Sequence mode:

1. On the measurement screen, push the **Profile** softkey.
The Profile info screen shows.
2. Push the **Load** softkey.
The Load profile screen shows.
3. Use the **Prev** and **Next** softkeys and   to select a profile.
4. Push the **Load** softkey.
5. Push the **Continue** softkey to load the selected profile.

Make Measurements

Test Battery Internal Resistance and Voltage or Strap Resistance

The Product can simultaneously test the internal resistance and voltage of a battery.

This helps you to understand the overall state of the battery health. The Product can also test strap resistance since upward changes could be caused by corrosion or loose connections.

To test battery internal resistance and voltage or strap resistance, turn the rotary switch to mΩ. See Figure 3-1.

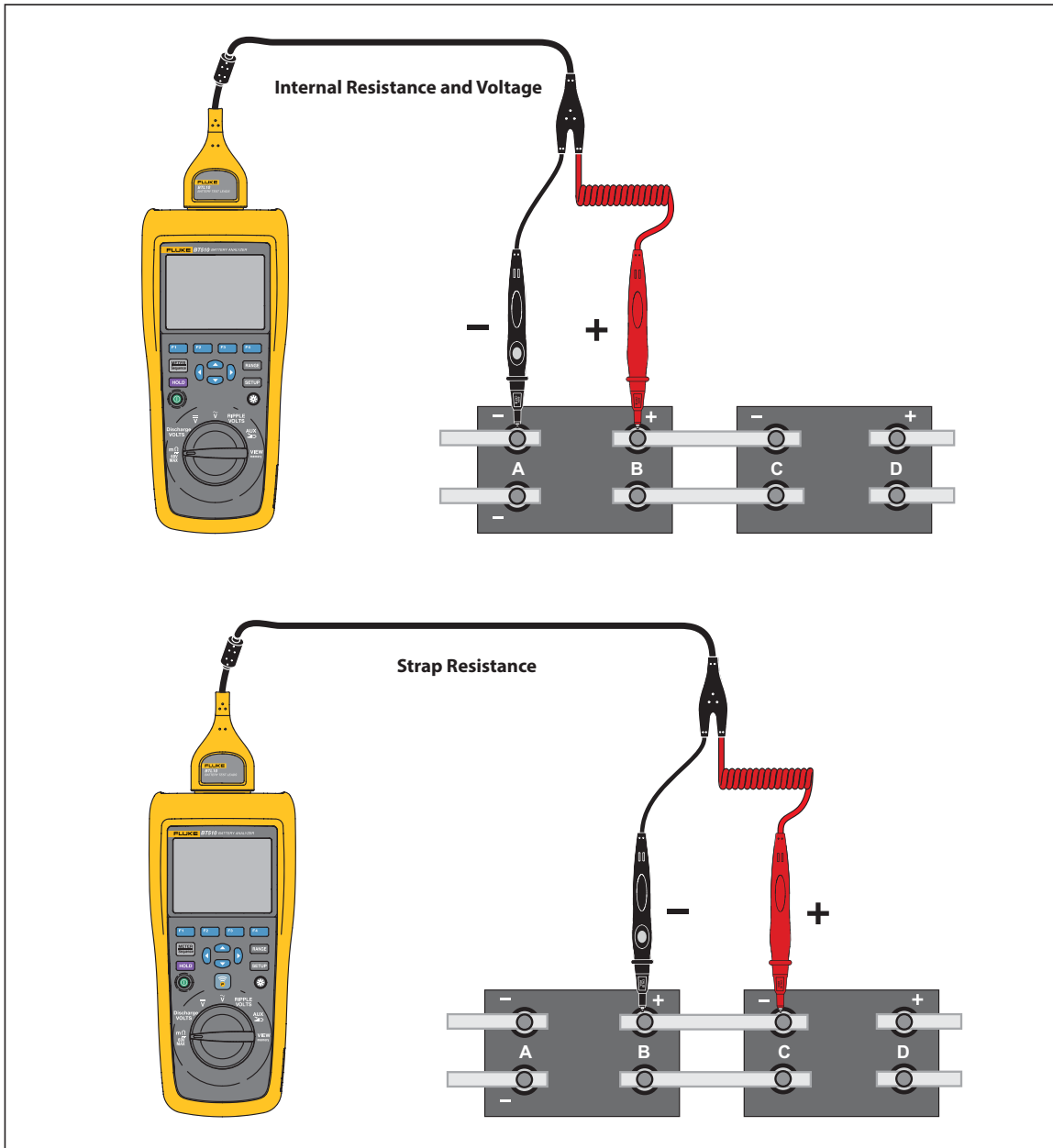

Figure 3-1. Test Battery Internal Resistance and Voltage or Strap Resistance

hpo068.eps

Battery Test Probes

To connect test probes to the battery pole:

1. Use the inner tip of the test probe to touch the target surface.
2. Push the test lead to set-back the inner tip, until both the inner tip and the outer tip are fully connected to the target surface. This will ensure a proper 4-wire connection to the battery terminal.

Note

Stable and correct readings are shown only when both the inner tip and the outer tip of the test probe are fully connected to the battery posts. To get more accurate battery internal resistance reading, do not connect the test probes to screws. See Figure 3-2.

Examine for open fuse before $m\Omega$ measurement by connecting the outer tips of both probes. If the $m\Omega$ reading changes from OL to dashes and then backs to OL, the fuse is good. If $m\Omega$ reading remains as OL, the fuse is open and needs a replacement.

In this function, the voltage between the positive and negative poles of a battery must be < 60 V. A voltage >60 V causes the fuse to open.

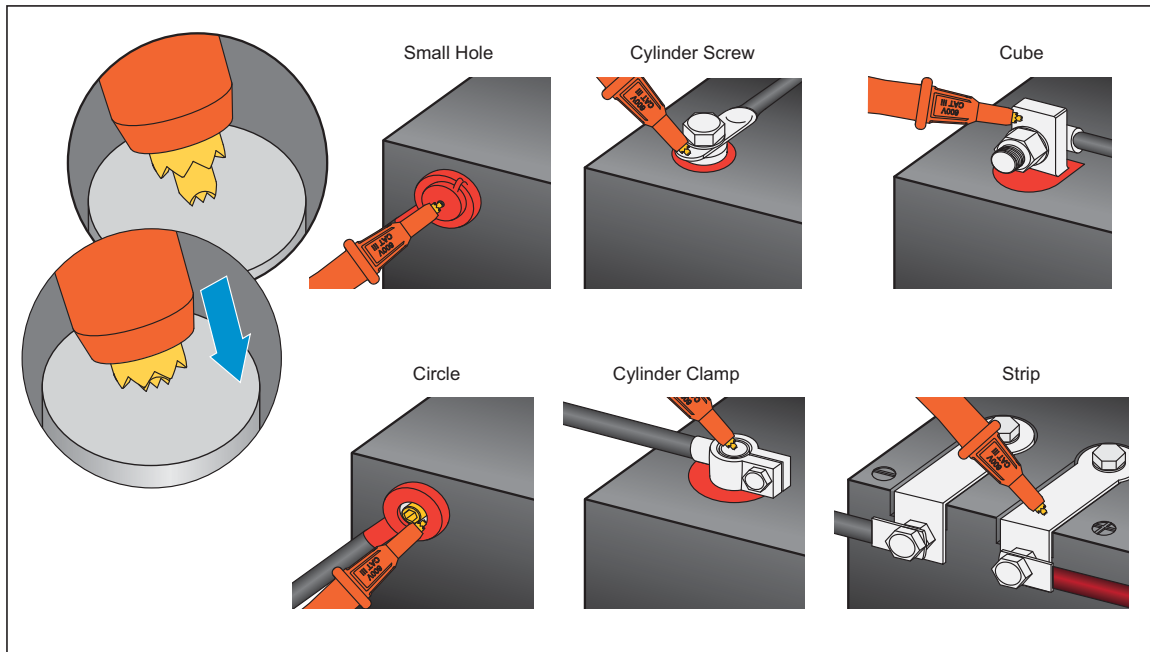
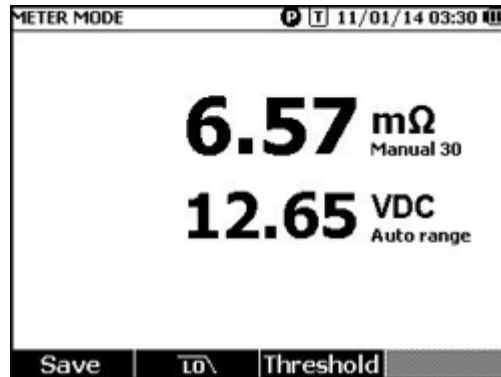

Figure 3-2. Connect Test Probe to Battery

hsz008.eps

View Test Readings on the Screen

This is a typical display of battery test in Meter mode.



hpo068.jpg

This is a typical display of battery test in Sequence mode:

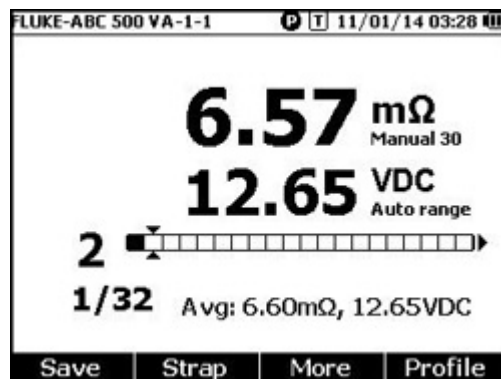

hpo069.jpg

Battery number: Indicates the number of the battery that has been tested.

Progress bar: The progress bar is generated according to the total number of batteries in the profile. Each cell corresponds to one battery. An empty cell indicates the corresponding battery is not tested yet. A full cell indicates the corresponding battery has been tested and the readings have been saved. A cross mark in a full cell indicates that the threshold function is enabled.

Cursors: Use \blacktriangleright and \blacktriangleleft to move the cursors. The number of the currently tested battery changes accordingly. When the cursors are positioned on a full cell, the corresponding reading of that battery will be shown under the progress bar.

Average readings: After two or more sets of test readings are saved, the Product shows the average readings, including average resistance and average voltage.

Tip: If the test readings of a battery are significantly different from the average readings, it could indicate the battery health has been compromised.

Measure Strap resistance in sequence mode

A strap string is created right behind battery string automatically in the same profile. The strap number equals to battery number. Push the **Strap** softkey to switch to strap string test. The display shows **S** to indicate strap string. Push **Battery** softkey to switch back to battery string test.

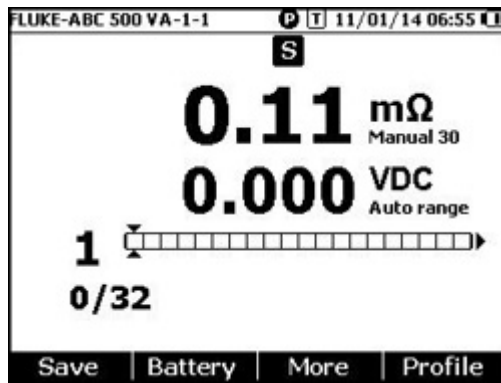

hpo070.jpg

Set Measurement Range

Battery resistance or Strap resistance only has manual ranges. The default range for battery resistance or Strap resistance measurement is 30 mΩ. You can push **RANGE** to cycle through different ranges in this sequence: 30 mΩ > 300 mΩ > 3000 mΩ > 3 mΩ. The battery voltage measurement is in auto ranging mode, and the range cannot be changed.

Save Battery Test Readings

In Meter mode, push the **Save** softkey to save the current resistance, voltage and time.

All saved data is stored in chronological order. In Sequence mode, push the **Save** softkey to save the current resistance and voltage readings. The current serial number increases by 1. The test progress bar moves to the right by one cell.

Note

If the test lead does not connect to battery or the test lead is not installed, the Save function is invalid.

Erase Test Readings

To erase the test readings for a certain battery in Sequence mode:

1. Use **←** and **→** to point the cursors to the cell that corresponds to the correct battery.
2. Push the **Erase** softkey.

The pointed cell becomes empty. Push the **Save** softkey to save new test readings for this battery.

Activate Low-Pass Filter for Resistance Measurement

Excessive high level of ac ripple voltage can have a negative impact on the battery resistance measurement. Use the built-in low pass filter to stabilize or reduce the impact of ac ripple on resistance measurements.

To activate the low-pass filter for battery resistance measurement, in Meter mode, push **LO** softkey, in Sequence mode, push the **More** softkey and push **LO** softkey. The display shows the **LO** icon.

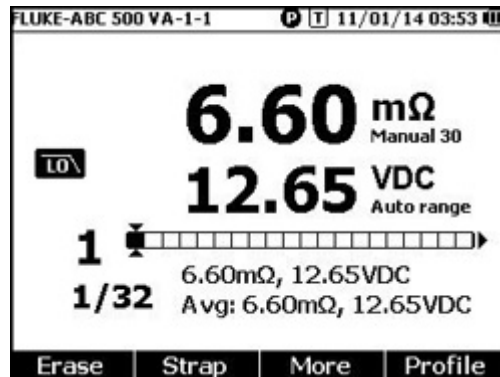

hpo071.jpg

Set Measurement Thresholds

The Product lets you define upper and lower measurement thresholds or tolerance ranges. These defined threshold values are then compared to the measured values to automatically identify and prompt the user with a **PASS**, **FAIL** or **WARN** indicator of battery out of tolerance conditions.

The threshold function is disabled by default. You can set up to 10 set of thresholds and select one threshold as needed.

To set and select measurement thresholds:

1. On the measurement screen, push the **More** softkey and **Threshold** softkey to open the Select Threshold menu.
2. Use **←** and **→** to select one threshold set out of ten.

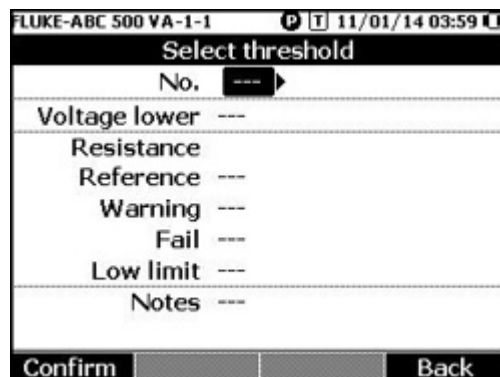

hpo072.jpg

3. Use **←** and **L** to highlight the value to be edited among **Voltage lower**, **Reference**, **Warning**, **Fail**, **Low limit**, and **Notes**.
4. Edit the selected field.
 - a. Use the **-** and **+** softkeys to change the values for **Warning** and **Fail**.

- b. For other fields, push the **Edit** softkey, use the arrow keys to edit the value, and then push the **Confirm** softkey to save the value.
5. Once all threshold values are correct, push the **Confirm** softkey on the save the threshold set.

The threshold set is applied and the **T-X** (X stands for value of **No.**) icon and the corresponding PASS/WARN/FAIL indication shows on the display.

To disable measurement thresholds:

1. On the measurement screen, push the **Threshold** softkey to open the Select Threshold menu.

The value of **No.** is already highlighted.

2. Use \leftarrow to set **No.** to ---.
3. Push the **Confirm** softkey.

The **T-X** icon no longer shows on the display.

How the Thresholds Work

When a threshold set is applied, the Product compares each resistance reading with the resistance reference in the current threshold set.

- If the reading is greater than reference x (1+Fail threshold) or less than the resistance lower limit, the comparison result is **FAIL**, indicating that the tested battery is potentially compromised and should be further investigated.
- If the reading is greater than Reference x (1 + Warning threshold) but less than Reference x (1 + Fail threshold), the comparison result is **WARN**, indicating that the tested battery requires further attention and increase in test frequency.
- If the reading is less than Reference (1+ Warning threshold), the comparison result is **PASS**, indicating that the tested battery is within the defined tolerance limits.

For example, you have applied a threshold set where **Resistance Reference** is set to 3.00 m Ω , **Warning** set to 20 %, Fail set to 50 %, and low limit set to 2.00 m Ω . The comparison result is **FAIL** for resistance readings greater than $3.00 \times (1 + 50 \%) = 4.50$ m Ω . It is **PASS** for resistance readings less than $3.00 \times (1 + 20 \%) = 3.60$ m Ω . It is **WARN** for resistance readings less than 4.50 m Ω but greater than 3.60 m Ω .

At the same time, the Product compares each stable voltage reading with the lower voltage from the applied threshold set. If the reading is less than the lower voltage threshold, the comparison result is **FAIL**. If the reading is greater than the threshold, the comparison result is **PASS**.

Note

If the resistance test and the voltage test have different results, the Product shows the worse result on the display. For example, the resistance indicates PASS but the voltage indicates FAIL, the Product still shows FAIL on the display.

Measure Discharge Voltage

In a typical battery load discharge test, you need to test the voltage of each battery in a battery string multiple rounds. In a typical load discharge test, the voltage of each battery is monitored from the start of the test when the batteries are at full capacity, until the voltage of any one battery while under constant load reaches a pre-defined minimum voltage level.

Make Measurements

To test discharge voltage:

1. Push  as necessary to enter Sequence mode.
2. Turn the rotary switch to **Discharge VOLTS**.

Note

Discharge voltage can only be measured in Sequence mode.

Typical Display

This is a typical display of discharge voltage measurement.

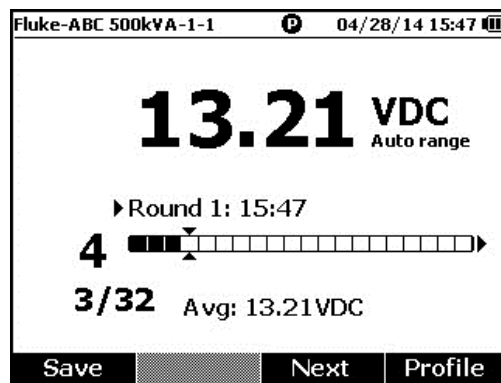



hpo052.jpg

Progress bar: Indicates the number of the battery that is being tested.

Battery ID and Total Number: The number to the left of / indicates the ID of the battery that has been tested. The number to the right of / indicates the total number of batteries in the profile.

Round Number and Test Time: The row above the progress bar shows the round number and the time when that test round was done.

Cursors: The number to the left of the progress bars indicates the ID of the battery that corresponds to the cursor-pointed cell. Push  and  to move the cursors. The number to the left of the progress bar changes accordingly. If the cursors are moved to a cell that corresponds to a battery with readings, the readings show under the progress bar.

Average readings: After you have saved two or more sets of test readings, the Product shows the average voltage reading in this round.

Push the **Save** softkey to save the current discharge voltage reading and the timestamp. The current battery number and the progress number automatically increases by 1. The cell that corresponds to the tested battery becomes full, and the cursors move forward.

Push the **F3** softkey to start the next round test. The test time will show beside the round number when the first reading is saved.

Note

You cannot go back to the previous round when you have started a new one.

Measure DC Voltage

The Product can measure dc voltage. It also shows the polarity on the display.

To measure dc voltage, turn the rotary switch to \overline{V} . See Figure 3-3 for connections.

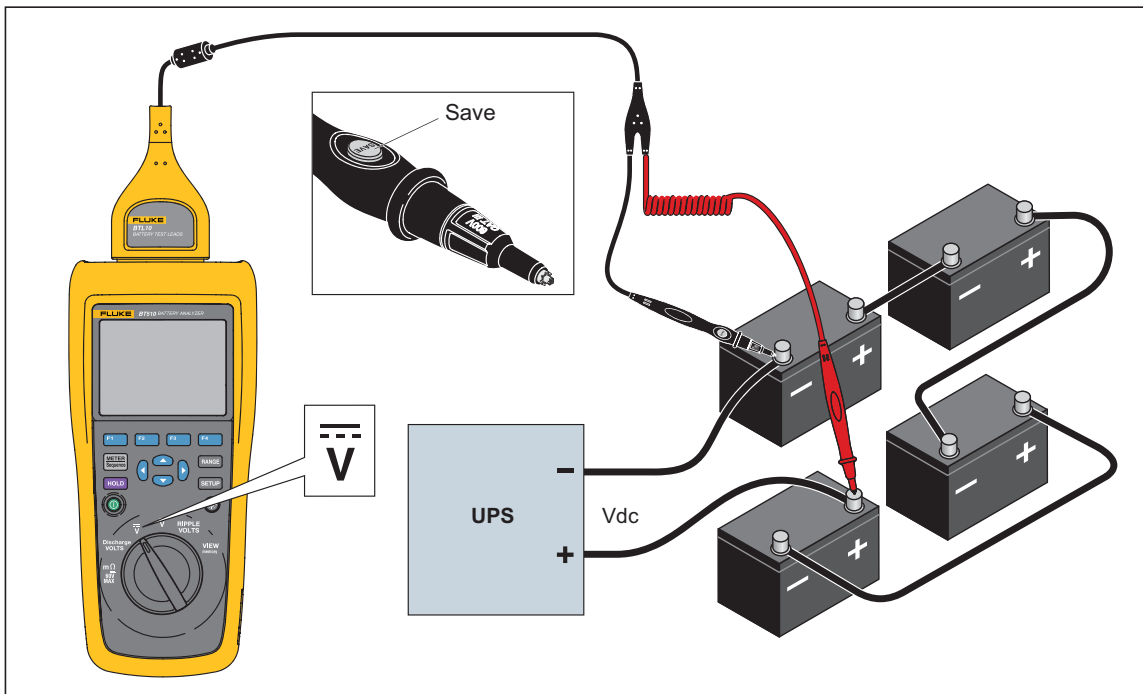

Figure 3-3. Measure DC Voltage

hpo019.eps

Set Measurement Range

In this measurement mode, auto range is used by default. When the input signal reaches 110 % of the upper limit of the current range, the Product automatically increases a range. When the input signal reaches 90 % of the lower limit of the current range, the Product automatically decreases a range.

To manually set the range, push **RANGE** to cycle through 6 V, 60 V, and 600 V.

Save DC Voltage Readings

In Meter mode, push the **Save** softkey to save the current dc voltage reading and the timestamp. All saved data is stored in chronological order.

In Sequence mode, push the **Save** softkey to save the current dc voltage reading and the timestamp. The current battery number automatically increases by 1. The cell that corresponds to the tested point becomes full, and the cursors move forward.

Measure AC Voltage

The Product supplies two independent readings to show the rms and frequency of ac voltage.

To measure ac voltage, turn the rotary switch to \tilde{V} . See Figure 3-4 for connections.

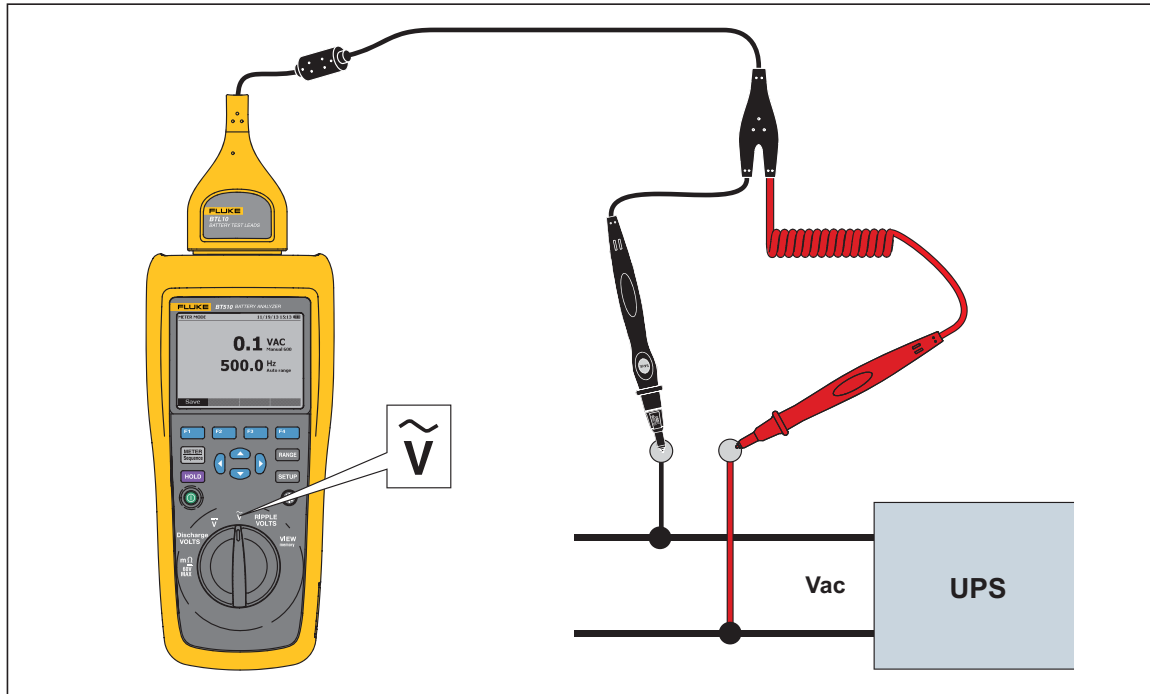

Figure 3-4. Measure AC Voltage

hpo021.eps

Measurement Range

The ac voltage measurement has only one range: 600 V. The frequency measurement uses auto ranging. This cannot be changed.

Save AC Voltage Readings

In Meter mode, push the **Save** softkey to save the current ac voltage reading and the timestamp. All saved data is stored in chronological order.

In Sequence mode, push the **Save** softkey to save the current ac voltage reading and the timestamp. The current battery number increases 1 automatically. The cell that corresponds to the tested point becomes full, and the cursors move forward.

Note

Up to 20 ac voltage readings can be saved in one profile.

Measure Ripple Voltage

The Product can measure the ac component on a dc voltage, which is also known as ac ripple. A high ac ripple may result in a battery overheat and negatively impact the battery life. In addition, it may cause extra energy loss to the system.

To measure ripple voltage, turn the rotary switch to **RIPPLE VOLTS**.

Set Measurement Range

In ripple voltage function, both ac voltage and dc voltage use auto range by default.

To manually set the range for ac voltage, push **RANGE** to switch between 600 mV and 6000 mV.

The measurement of dc voltage uses auto range. This cannot be changed.

Save Ripple Voltage Readings

In Meter mode, push the **Save** softkey to save the current ripple voltage reading and the timestamp. All saved data is stored in chronological order.

In Sequence mode, push the **Save** softkey to save the current ripple voltage reading and the timestamp. The current battery number automatically increases by 1. The cell that corresponds to the tested point becomes full, and the cursors move forward.

Note

Up to 20 ripple voltage readings can be saved in one profile.

Measure Voltage with TL175

With the TL175 test lead, the Product can measure Discharge Volts, VDC, VAC, and Ripple Volts.

To measure voltage:

1. Connect TL175 to the BTL_A adapter.
2. Connect the BTL_A adapter to the Product.
3. Turn the rotary switch to the necessary position.

For details about the measurements, refer to the “Measure Discharge Volts”, “Measure DC Voltage”, “Measure AC Voltage” and “Measure Ripple Voltage” sections.

As an example, Figure 3-5 shows how to measure dc voltage with the TL175 test lead.

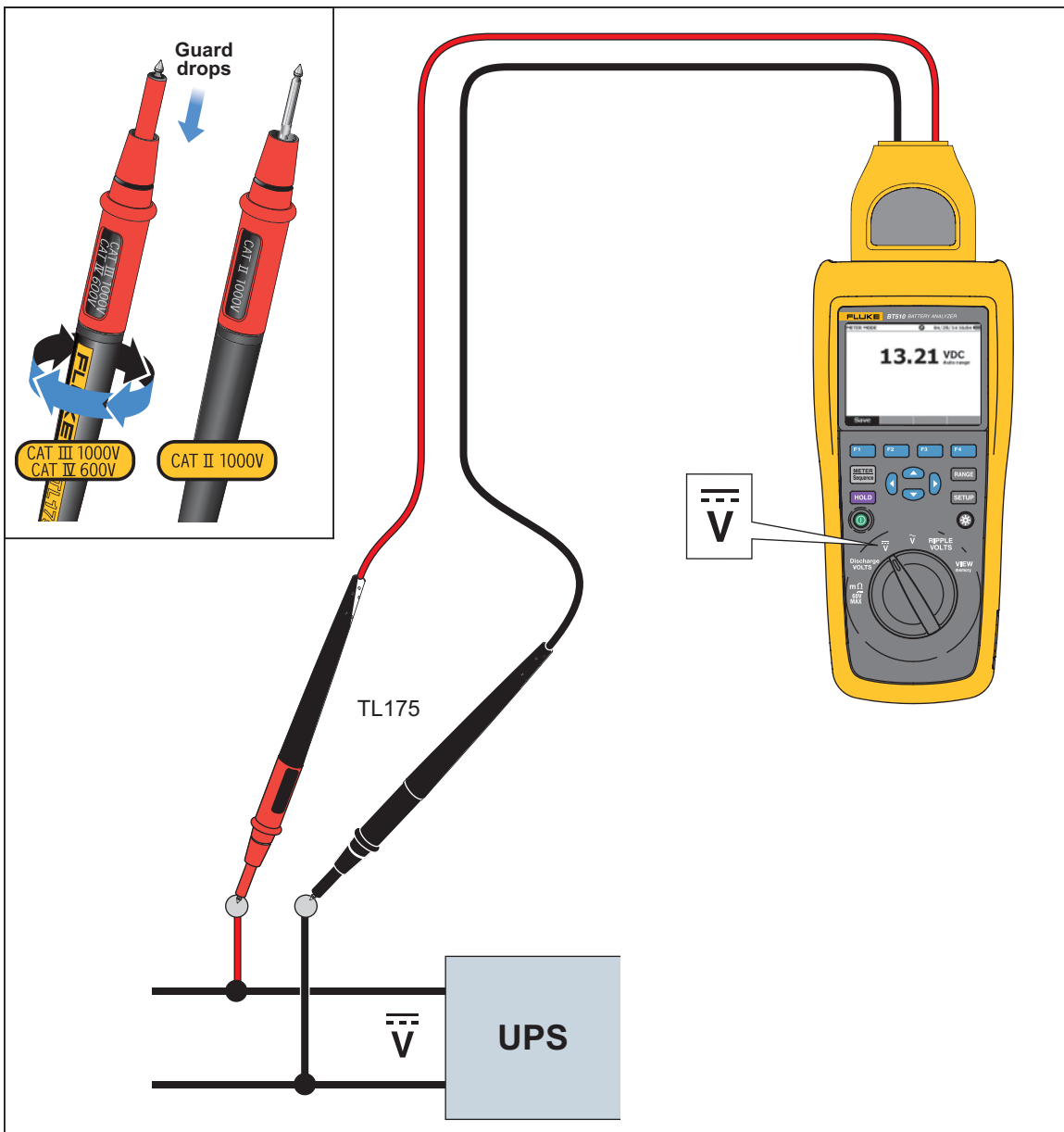

Figure 3-5. Measure DC Voltage with TL175

hpo053.eps

Chapter 4

View Memory



Introduction

This chapter provides information about how to view measurement data that is manually or automatically saved to the Product memory.

The Product has an internal memory that stores measurement data that can be viewed. Measurement data in Meter mode and Sequence mode shows separately. The total memory usage can be viewed in the Setup menu.

View Data Saved in Meter Mode

To view measurement data that is saved in Meter mode:

1. Turn the rotary switch to **VIEW memory**.
2. Push  until **MEMORY – METER** shows on the upper left corner of the display.
3. View the memory items, and push the **Next** softkey to view next page as required.
4. Use  to cycle through these four data sets: **mΩ.V**, **VDC**, **VAC**, and **Ripple**.

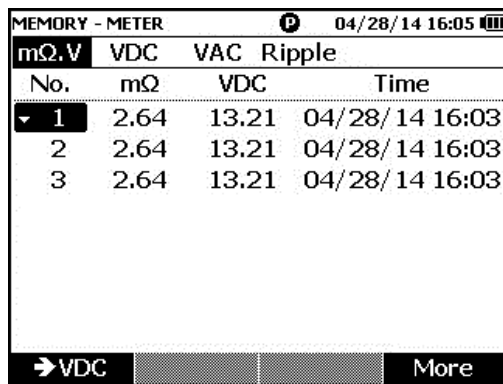



MEMORY - METER				04/28/14 16:05
mΩ.V	VDC	VAC	Ripple	
No.	mΩ	VDC	Time	
1	2.64	13.21	04/28/14 16:03	
2	2.64	13.21	04/28/14 16:03	
3	2.64	13.21	04/28/14 16:03	

→VDC More

hpo063.jpg

Delete Data Saved in Meter Mode

To delete data saved in meter mode:

1. Turn the rotary switch to **VIEW memory**.
2. Push  until **MEMORY – METER** shows on the upper left corner of the display.
3. When the data to be deleted shows on the display, push the **More** softkey.
 - a. To delete data entries one by one, use  and  to highlight a data entry, and then push the **Delete** softkey.

When the display shows **Confirm to delete the reading?**, push the **Delete** softkey.

- b. To delete all data in the measurement set, push the **Delete all** softkey.

When the display shows **Confirm to delete all readings?**, push the **Delete** softkey.

MEMORY - METER				
mΩ.V	VDC	VAC	Ripple	
No.	mΩ	VDC	Time	
1	2.64	13.21	04/28/14 16:03	
2	2.64	13.21	04/28/14 16:03	
3	2.64	13.21	04/28/14 16:03	

Delete | Delete all | Back

hpo064.jpg

View Profiles Saved in Sequence Mode

To view measurement data that is saved in Sequence mode:

1. Turn the rotary switch to **VIEW memory**.
2. Push until **MEMORY – SEQUENCE** shows on the upper left corner of the display. The Load profile menu shows on the display.
3. Use and to highlight a profile, and push the **View** softkey.
4. View the memory items, and push the **Next** softkey to view next page as required.
5. Use to cycle through these four data sets: **mΩ.V**, **Dis.V**, **VDC**, **VAC**, and **Ripple**.



MEMORY - SEQUENCE					
mΩ.V	Dis.V	VDC	VAC	Ripple	
No.	mΩ	VDC	Time		
1	2.64	13.21	04/28/14 15:44		
2	2.64	13.21	04/28/14 15:44		
3	2.64	13.21	04/28/14 15:44		
4	2.64	13.21	04/28/14 15:44		
5	---	---			
6	---	---			
7	2.64	13.21	04/28/14 15:45		

→Dis.V | Next | Back

hpo065.jpg

Delete Profiles Saved in Sequence Mode

To delete data saved in Sequence mode:

1. Turn the rotary switch to **VIEW** memory.
2. Push  until **MEMORY – SEQUENCE** shows on the upper left corner of the display.
3. When the **View profile** menu shows on the display, use  and  to highlight a profile, and push the **More** softkey.

- a. To delete only the highlighted profile, push the **Delete** softkey.

When the display shows **Confirm to delete current profile?**, push the **Delete** softkey.

- b. To delete all profiles, push the **Delete all** softkey.



hpo066.jpg



hpo067.jpg

4. When the display shows **Confirm to delete all profiles?**, push the **Delete** softkey.

Chapter 5

Connection to PC

Introduction

This chapter contains information about how to connect the Product to a PC.

Connect the Product to PC

The Product has a USB port that lets you connect the Product to a PC via a USB cable. See Figure 5-1.

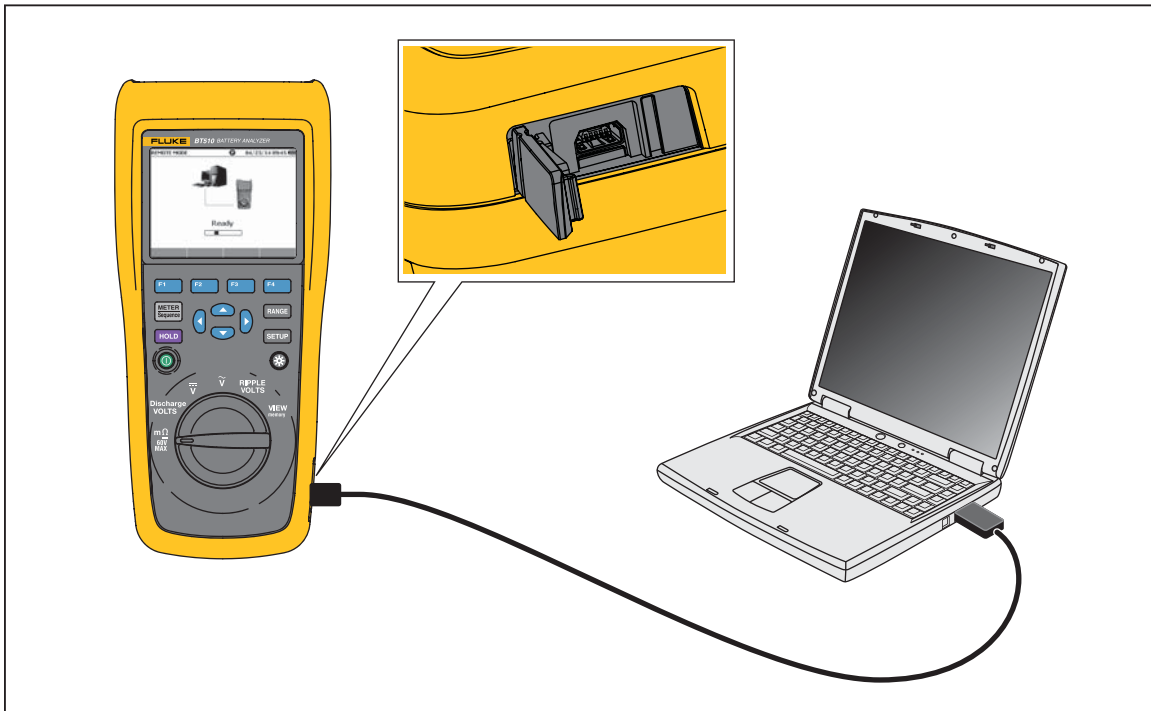

Figure 5-1. Connection to PC

hpo030.eps

When connected to a PC, the PC Application can:

- View data from Product memory
- Export data from Product memory
- Import data to Product memory
- Delete data from the Product memory
- Upgrade the Product firmware

Note

Please refer to PC Application help file for how to use the application.

Chapter 6

Maintenance

Introduction

This chapter covers basic maintenance procedures.

Warning

For safe operation and maintenance of the Product:

- Use only specified replacement parts.
- Use only specified replacement fuses.
- Have an approved technician repair the Product.
- The battery door must be closed and locked before you operate the Product.
- Batteries contain hazardous chemicals that can cause burns or explode. If exposure to chemicals occurs, clean with water and get medical aid.
- Remove the input signals before you clean the Product.
- Do not disassemble or crush battery cells and battery packs.
- Do not put battery cells and battery packs near heat or fire. Do not put in sunlight.
- A low battery indication on display may prevent the Product from taking a measurement.
- Keep the battery pack out of the reach of children and animals.
- Do not subject battery packs to severe impacts such as mechanical shock.
- Do not use any charger other than that specifically provided for use with the Product.
- Do not use any battery which is not designed or recommended by Fluke for use with the Product.
- Remove all probes, test leads, and accessories before the battery door is opened.
- Repair the Product before use if the battery leaks.

- **Remove the batteries if the Product is not used for an extended period of time, or if stored in temperatures that exceed the specification of the battery manufacturer. If the batteries are not removed, battery leakage can damage the Product.**
- **Connect the battery charger to the mains power outlet before the Product.**
- **Use only Fluke approved power adapters to charge the battery.**
- **Keep cells and battery packs clean and dry. Clean dirty connectors with a dry, clean cloth.**
- **Do not keep cells or batteries in a container where the terminals can be shorted.**
- **Ensure fuse continuity. If the protective fuse opens, the m Ω function will display 'OL' with all probe tip conductors short circuited.**
- **Replace a blown fuse with exact replacement only for continued protection against arc flash.**
- **After extended periods of storage, it may be necessary to charge and discharge the battery packs several times to obtain maximum performance.**

Install or Replace the Battery Pack

⚠⚠ Warning

**Never operate the Product with the Battery Cover removed.
Hazardous voltage exposure may occur.**

To install or replace a Battery Pack:

1. Make sure the Product is off.
2. Remove all probes and/or test leads.
3. Unlock the battery cover at the rear of the Product. Turn the screw a half turn.
4. Install the battery pack.
5. Put the battery cover back on the unit.
6. Tighten the screw.

Figure 6-1 shows how to install or replace a battery pack.

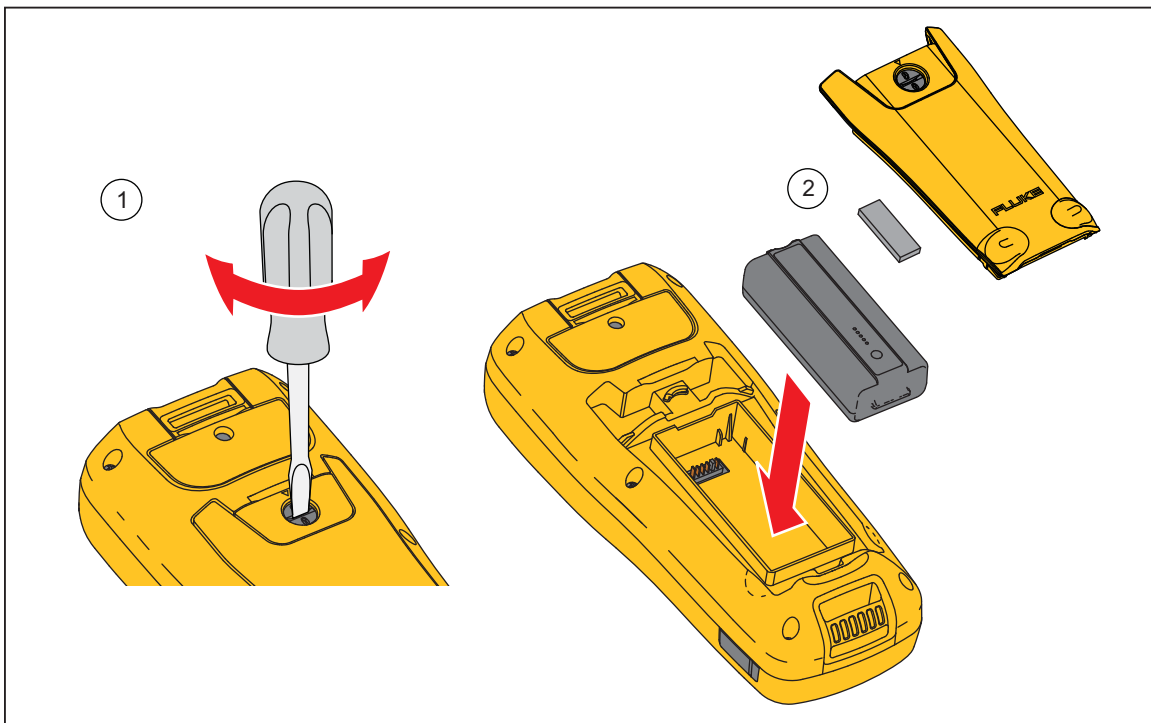

Figure 6-1. Install or Replace a Battery Pack

hsz005.eps

Replace the Fuse

Warning

To prevent possible electrical shock, fire, or personal injury:

- Use only specified replacement fuses.
- Replace a blown fuse with exact replacement only for continued protection against arc flash.

To replace the fuse:

1. Make sure the Product is off and any test leads are disconnected.
2. Use a screwdriver to loosen the captive screw on the fuse cover at the upper end of the Product.
3. Install the new fuse.
4. Reinstall the fuse cover.
5. Tighten the fuse cover screw.

See Figure 6-2.

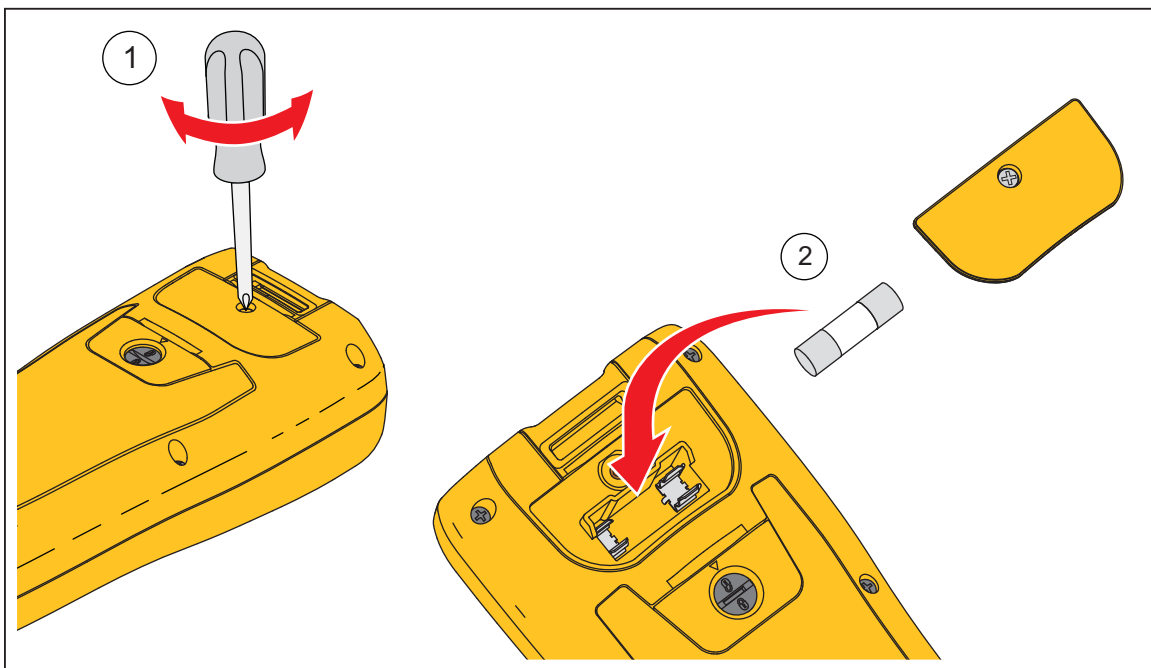

Figure 6-2. Replace the Fuse

hsz006.eps

Replace the Probe Tips

Figure 6-3 shows how to replace the probe tips.

⚠⚠ Warning

To prevent possible electrical shock, fire, or personal injury, use correct tip covers (CAT II or CAT III) in different CAT environments.

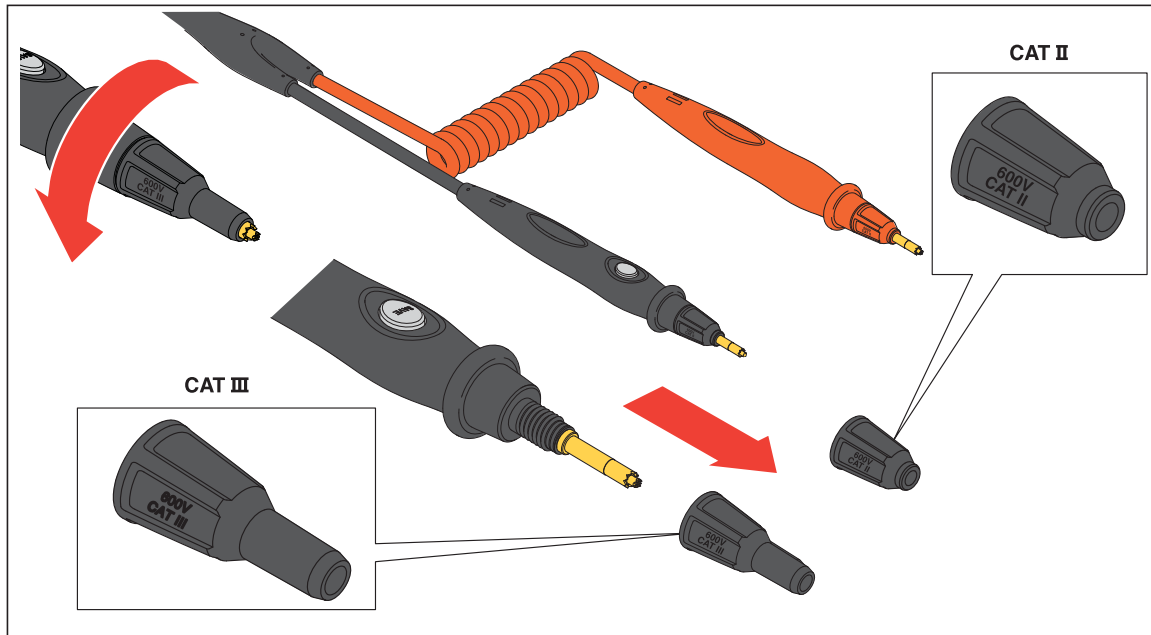

Figure 6-3. Replace the Probe Tips

hpo026.eps

Zero Calibration

This chapter describes how to do zero calibration. A zero calibration is required each time after a test probe is replaced.

To do zero calibration:

1. Locate the zero calibration board on a flat surface horizontally. See Figure 6-4.
2. Set zero calibration in the Setup menu.
 - a. Push **SETUP**.
 - b. Push ∇ until **General** is highlighted.
 - c. Push the **Select** softkey.
 - d. Push ∇ until **Zero calibration** is highlighted.
 - e. Push the **Zero** softkey.
3. Insert the red and black probe tips to the calibration holes.
4. Push the **Calibrate** softkey.

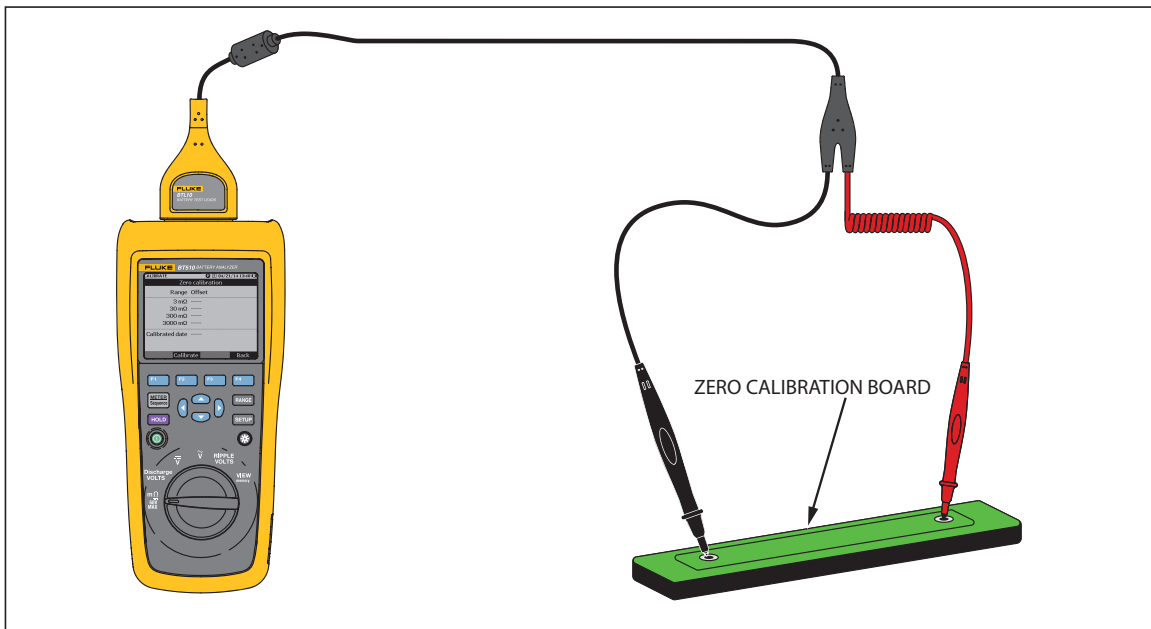

Figure 6-4. Zero Calibration Setup

hpo028.eps

The Product starts zero calibration for all function ranges. After the zero calibration is completed, the Product beeps to indicate a success and automatically exits zero calibration mode.

Note

During zero calibration, make sure the inner and outer pins of the probe tips are fully connected to the calibration board.

Clean the Product

Warning

For safe operation and maintenance of the Product, disconnect the Product and its accessories from all voltage sources during cleaning.

Clean the Product with a damp cloth and a mild soap. Do not use abrasives, solvents, or alcohol. These may damage the Product markings and labels.

Charge the Battery

At delivery, the Lithium ion batteries may be empty and must be charged for 4 hours (with the test tool turned off) to reach full charge. When fully charged, the batteries provide 8 hours of use.

When battery power is used, the battery indicator at the top of the screen informs you about the condition of the batteries.

To charge the batteries, connect the battery charger as shown in Figure 6-5.

Caution

To avoid overheating of the batteries during charging, do not exceed the allowable ambient temperature given in the specifications.

Note

During charging, all measurement functions are disabled, LCD displays charging status.

No damage will occur if the charger is connected for long periods, e.g., during the weekend. The instrument then automatically switches to trickle charging.

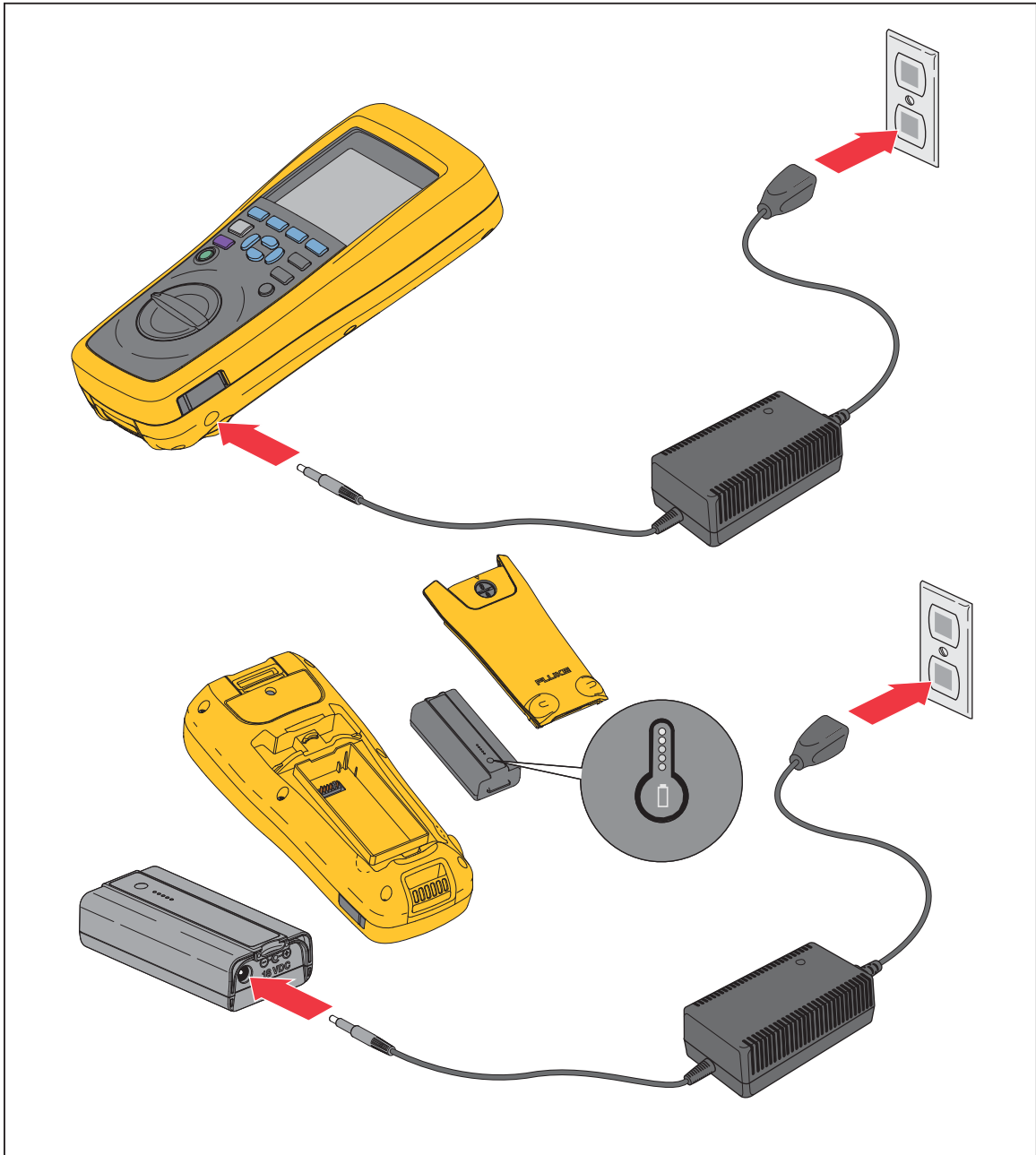

Figure 6-5. Charge the Battery

hpo032.eps

Parts and Accessories

Table 6-1 lists the user-replaceable parts and accessories. To order replacement parts or additional accessories, contact your nearest Fluke Service Center. See the “Contact Fluke” section.

Table 6-1. Parts and Accessories

Item No.	Description	Fluke Part Number	Quantity
①	BTL10, Basic Test Lead	--	1
②	TL175, TwistGuard™ Test Leads	--	1
③	BTL_A, Voltage/Current Probe Adapter	--	1
④	BP500, 7.4 V 3000 mAh Lithium-ion battery	4398817	1
⑤	BC500, 18 V dc charger	4459488	1
⑥	Power cord	--	1
⑦	Standard mini-b USB cable (cable length: 1 m)	4499448	1
⑧	BCR, Zero calibration board	4497419	1
⑨	Shoulder strap	4490029	1
⑩	Belt strap	4490316	1
⑪	Magnetic plate	4329190	1
⑫	C500S Soft carrying case, small	4462874	1
⑬	Spare fuse	943121	2
⑭	Safety Sheet	4453942	1
⑮	Warranty card	2396000	1
⑯	Quick Reference Guide	4453956	1
⑰	FlukeView® Battery (CD) containing USB driver and manuals in all languages	4529552	1

