

Technical Information

Proline Promass Q 300

Coriolis flowmeter



The innovative specialist for challenging applications with a compact, easily accessible transmitter

Application

- Measuring principle operates independently of physical fluid properties such as viscosity or density
- Highest measurement performance for custody transfer, density and under difficult process conditions

Device properties

- Mass flow: Measured error $\pm 0.05\%$ (PremiumCal)
- Density: Measured error $\pm 0.2\text{ kg/m}^3$
- High turndown due to low pressure loss/zero point
- Compact dual-compartment housing with up to 3 I/Os
- Backlit display with touch control and WLAN access
- Remote display available

Your benefits

- Guaranteed measurement quality – premium accuracy for mass flow, volume flow and density
- Optimized performance for liquids with entrained gas – MFT (multi-frequency technology)
- Fewer process measuring points – multivariable measurement (flow, density, temperature)
- Space-saving installation – no inlet/outlet run needs
- Full access to process and diagnostic information – numerous, freely combinable I/Os and fieldbuses
- Reduced complexity and variety – freely configurable I/O functionality
- Integrated verification – Heartbeat Technology

Table of contents





About this document	4	Storage temperature	54
Symbols	4	Climate class	54
Function and system design	5	Degree of protection	54
Measuring principle	5	Vibration- and shock-resistance	54
Measuring system	6	Interior cleaning	55
Equipment architecture	7	Electromagnetic compatibility (EMC)	55
Safety	7	Process	55
Input	10	Medium temperature range	55
Measured variable	10	Density	56
Measuring range	10	Pressure-temperature ratings	56
Operable flow range	11	Sensor housing	59
Input signal	11	Rupture disk	60
Output	13	Flow limit	60
Output and input variants	13	Pressure loss	60
Output signal	15	System pressure	60
Signal on alarm	20	Thermal insulation	61
Load	23	Heating	61
Ex connection data	23	Vibrations	61
Low flow cut off	24	Custody transfer measurement	62
Galvanic isolation	24	Mechanical construction	63
Protocol-specific data	25	Dimensions in SI units	63
Power supply	30	Dimensions in US units	75
Terminal assignment	30	Weight	81
Device plugs available	30	Materials	82
Supply voltage	32	Process connections	84
Power consumption	32	Surface roughness	84
Current consumption	32	Human interface	85
Power supply failure	32	Operating concept	85
Electrical connection	32	Languages	85
Potential equalization	42	Local operation	85
Terminals	42	Remote operation	86
Cable entries	42	Service interface	92
Pin assignment, device plug	42	Network integration	93
Cable specification	43	Supported operating tools	94
Performance characteristics	46	HistoROM data management	95
Reference operating conditions	46	Certificates and approvals	97
Maximum measured error	46	CE mark	97
Repeatability	47	RCM-tick symbol	97
Response time	48	Ex approval	97
Influence of ambient temperature	48	Sanitary compatibility	98
Influence of medium temperature	48	Pharmaceutical compatibility	98
Influence of medium pressure	49	Functional safety	98
Design fundamentals	49	HART certification	99
Installation	50	FOUNDATION Fieldbus certification	99
Mounting location	50	Certification PROFIBUS	99
Orientation	51	EtherNet/IP certification	99
Inlet and outlet runs	52	Certification PROFINET	99
Special mounting instructions	52	Pressure Equipment Directive	99
Environment	54	Radio approval	100
Ambient temperature range	54	Measuring instrument approval	100
		Additional certification	100
		Other standards and guidelines	100

Ordering information	101
Application packages	101
Diagnostics functions	102
Heartbeat Technology	102
Concentration	102
Petroleum	102
OPC-UA server	102
Accessories	103
Device-specific accessories	103
Communication-specific accessories	104
Service-specific accessories	105
System components	105
Supplementary documentation	106
Standard documentation	106
Device-dependent additional documentation	106
Registered trademarks	107





About this document

Symbols









Electrical symbols

Symbol	Meaning
	Direct current
	Alternating current
	Direct current and alternating current
	Ground connection A grounded terminal which, as far as the operator is concerned, is grounded via a grounding system.
	Protective Earth (PE) A terminal which must be connected to ground prior to establishing any other connections. The ground terminals are situated inside and outside the device: <ul style="list-style-type: none"> ▪ Inner ground terminal: Connects the protective earth to the mains supply. ▪ Outer ground terminal: Connects the device to the plant grounding system.



Communication symbols

Symbol	Meaning
	Wireless Local Area Network (WLAN) Communication via a wireless, local network.
	LED Light emitting diode is off.
	LED Light emitting diode is on.
	LED Light emitting diode is flashing.

Symbols for certain types of information

Symbol	Meaning
	Permitted Procedures, processes or actions that are permitted.
	Preferred Procedures, processes or actions that are preferred.
	Forbidden Procedures, processes or actions that are forbidden.
	Tip Indicates additional information.
	Reference to documentation.
	Reference to page.
	Reference to graphic.
	Visual inspection.

Symbols in graphics

Symbol	Meaning
1, 2, 3, ...	Item numbers
1, 2, 3, ...	Series of steps
A, B, C, ...	Views
A-A, B-B, C-C, ...	Sections
	Hazardous area
	Safe area (non-hazardous area)
	Flow direction

Function and system design

Measuring principle

The measuring principle is based on the controlled generation of Coriolis forces. These forces are always present in a system when both translational and rotational movements are superimposed.

$$F_c = 2 \cdot \Delta m (v \cdot \omega)$$

F_c = Coriolis force

Δm = moving mass

ω = rotational velocity

v = radial velocity in rotating or oscillating system

The amplitude of the Coriolis force depends on the moving mass Δm , its velocity v in the system and thus on the mass flow. Instead of a constant rotational velocity ω , the sensor uses oscillation.

In the sensor, two parallel measuring tubes containing flowing fluid oscillate in antiphase, acting like a tuning fork. The Coriolis forces produced at the measuring tubes cause a phase shift in the tube oscillations (see illustration):

- At zero flow (when the fluid is at a standstill) the two tubes oscillate in phase (1).
- Mass flow causes deceleration of the oscillation at the inlet of the tubes (2) and acceleration at the outlet (3).

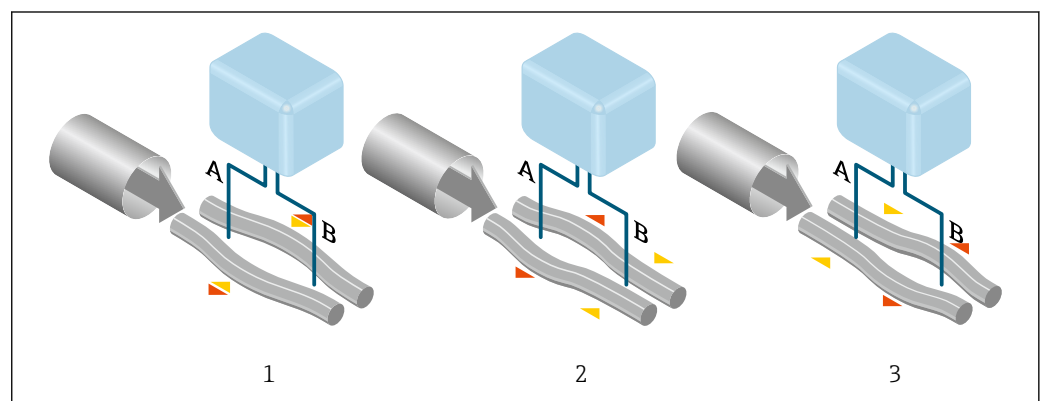

A0028850

The phase difference (A-B) increases with increasing mass flow. Electrodynamics sensors register the tube oscillations at the inlet and outlet. System balance is ensured by the antiphase oscillation of the two measuring tubes. The measuring principle operates independently of temperature, pressure, viscosity, conductivity and flow profile.

Density measurement

The measuring tube is continuously excited at its resonance frequency. A change in the mass and thus the density of the oscillating system (comprising measuring tube and fluid) results in a corresponding, automatic adjustment in the oscillation frequency. Resonance frequency is thus a function of medium density. The microprocessor utilizes this relationship to obtain a density signal.

Volume measurement

Together with the measured mass flow, this is used to calculate the volume flow.

Temperature measurement

The temperature of the measuring tube is determined in order to calculate the compensation factor due to temperature effects. This signal corresponds to the process temperature and is also available as an output signal.

Measuring system

The device consists of a transmitter and a sensor.

The device is available as a compact version:

The transmitter and sensor form a mechanical unit.

Transmitter

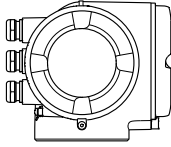
<p>Proline 300</p>  <p style="text-align: right;">A0026708</p>	<p>Device versions and materials:</p> <ul style="list-style-type: none"> ▪ Transmitter housing <ul style="list-style-type: none"> ▪ Aluminum, coated: aluminum, AlSi10Mg, coated ▪ Stainless, hygienic: stainless steel, 1.4404 ▪ Cast, stainless: cast, stainless steel, 1.4409 (CF3M) similar to 316L ▪ Material of window in transmitter housing: <ul style="list-style-type: none"> ▪ Aluminum, coated: glass ▪ Stainless, hygienic: polycarbonate ▪ Cast, stainless: glass <p>Configuration:</p> <ul style="list-style-type: none"> ▪ External operation via 4-line, backlit, graphic local display with touch control and guided menus ("Make-it-run" wizards) for application-specific commissioning. ▪ Via service interface or WLAN interface: <ul style="list-style-type: none"> ▪ Operating tools (e.g. FieldCare, DeviceCare) ▪ Web server (access via Web browser, e.g. Microsoft Internet Explorer, Microsoft Edge)
--	--

Sensor

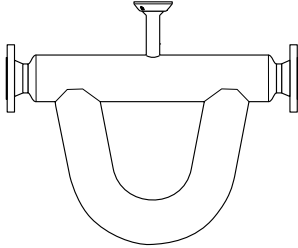
<p>Promass Q</p>  <p style="text-align: right;">A0030075</p>	<ul style="list-style-type: none"> ▪ Bent dual-tube system ▪ Excellent performance across a wide range of applications ▪ Simultaneous measurement of flow, volume flow, density and temperature (multivariable) ▪ Immune to process influences ▪ Nominal diameter range: DN 25 to 100 (1 to 4") ▪ Materials: <ul style="list-style-type: none"> ▪ Sensor: stainless steel, 1.4404 (316L) ▪ Measuring tubes: stainless steel, 1.4404 (316/316L) ▪ Process connections: stainless steel, 1.4404 (316/316L)
--	--

Equipment architecture

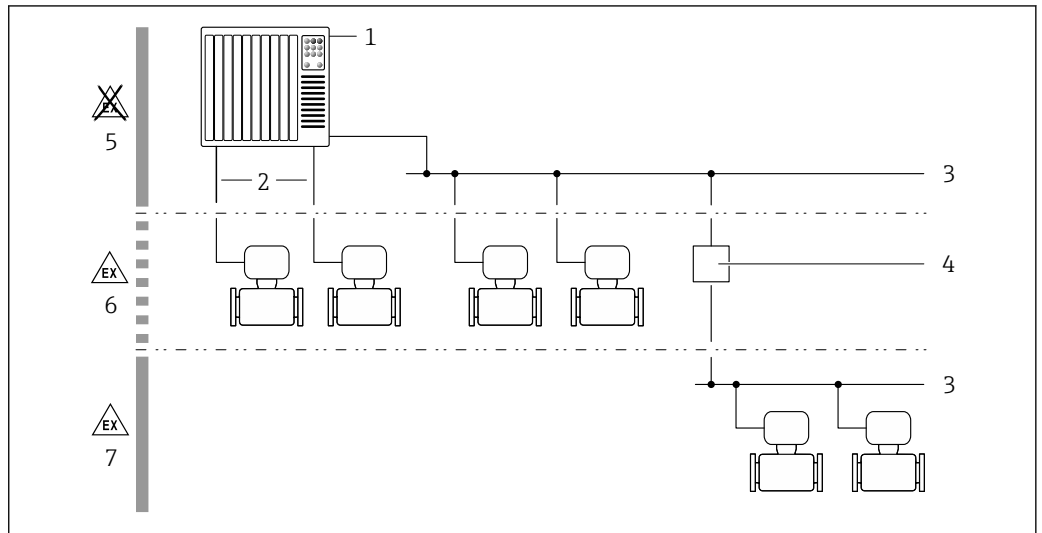

A0027512

1 Possibilities for integrating measuring devices into a system

- 1 Control system (e.g. PLC)
- 2 Connecting cable (0/4 to 20 mA HART etc.)
- 3 Fieldbus
- 4 Coupler
- 5 Non-hazardous area
- 6 Hazardous area: Zone 2; Class I, Division 2
- 7 Hazardous area: Zone 1; Class I, Division 1

Safety

IT security

Our warranty is valid only if the device is installed and used as described in the Operating Instructions. The device is equipped with security mechanisms to protect it against any inadvertent changes to the settings.

IT security measures, which provide additional protection for the device and associated data transfer, must be implemented by the operators themselves in line with their security standards.

Device-specific IT security

The device offers a range of specific functions to support protective measures on the operator's side. These functions can be configured by the user and guarantee greater in-operation safety if used correctly. An overview of the most important functions is provided in the following section.

Function/interface	Factory setting	Recommendation
Write protection via hardware write protection switch → 8	Not enabled.	On an individual basis following risk assessment.
Access code (also applies for Web server login or FieldCare connection) → 8	Not enabled (0000).	Assign a customized access code during commissioning.
WLAN (order option in display module)	Enabled.	On an individual basis following risk assessment.
WLAN security mode	Enabled (WPA2-PSK)	Do not change.
WLAN passphrase (password) → 8	Serial number	Assign an individual WLAN passphrase during commissioning.
WLAN mode	Access Point	On an individual basis following risk assessment.
Web server → 8	Enabled.	On an individual basis following risk assessment.
CDI-RJ45 service interface → 9	-	On an individual basis following risk assessment.

Protecting access via hardware write protection

Write access to the device parameters via the local display, Web browser or operating tool (e.g. FieldCare, DeviceCare) can be disabled via a write protection switch (DIP switch on the motherboard). When hardware write protection is enabled, only read access to the parameters is possible.

Hardware write protection is disabled when the device is delivered.

Protecting access via a password

Different passwords are available to protect write access to the device parameters or access to the device via the WLAN interface.

- **User-specific access code**
Protect write access to the device parameters via the local display, Web browser or operating tool (e.g. FieldCare, DeviceCare). Access authorization is clearly regulated through the use of a user-specific access code.
- **WLAN passphrase**
The network key protects a connection between an operating unit (e.g. notebook or tablet) and the device via the WLAN interface which can be ordered as an option.
- **Infrastructure mode**
When the device is operated in infrastructure mode, the WLAN passphrase corresponds to the WLAN passphrase configured on the operator side.

User-specific access code

Write access to the device parameters via the local display, Web browser or operating tool (e.g. FieldCare, DeviceCare) can be protected by the modifiable, user-specific access code.

WLAN passphrase: Operation as WLAN access point

A connection between an operating unit (e.g. notebook or tablet) and the device via the WLAN interface, which can be ordered as an optional extra, is protected by the network key. The WLAN authentication of the network key complies with the IEEE 802.11 standard.

When the device is delivered, the network key is pre-defined depending on the device. It can be changed via the **WLAN settings** submenu in the **WLAN passphrase** parameter.

Infrastructure mode

A connection between the device and WLAN access point is protected by means of an SSID and passphrase on the system side. Please contact the relevant system administrator for access.

General notes on the use of passwords

- The access code and network key supplied with the device should be changed during commissioning.
- Follow the general rules for generating a secure password when defining and managing the access code or network key.
- The user is responsible for the management and careful handling of the access code and network key.

Access via Web server

The device can be operated and configured via a Web browser with the integrated Web server. The connection is via the service interface (CDI-RJ45) or the WLAN interface. For device versions with the EtherNet/IP and PROFINET communication protocols, the connection can also be established via the terminal connection for signal transmission with EtherNet/IP or PROFINET (RJ45 connector).

The Web server is enabled when the device is delivered. The Web server can be disabled if necessary (e.g. after commissioning) via the **Web server functionality** parameter.

The device and status information can be hidden on the login page. This prevents unauthorized access to the information.



For detailed information on device parameters, see:
The "Description of Device Parameters" document → 106

Access via OPC-UA

The "OPC UA Server" application package is available in the device version with the HART communication protocol → 102.

The device can communicate with OPC UA clients using the "OPC UA Server" application package.

The OPC UA server integrated in the device can be accessed via the WLAN access point using the WLAN interface - which can be ordered as an optional extra - or the service interface (CDI-RJ45) via Ethernet network. Access rights and authorization as per separate configuration.

The following Security Modes are supported as per the OPC UA Specification (IEC 62541):

- None
- Basic128Rsa15 – signed
- Basic128Rsa15 – signed and encrypted

Access via service interface (CDI-RJ45)

The device can be connected to a network via the service interface (CDI-RJ45). Device-specific functions guarantee the secure operation of the device in a network.

The use of relevant industrial standards and guidelines that have been defined by national and international safety committees, such as IEC/ISA62443 or the IEEE, is recommended. This includes organizational security measures such as the assignment of access authorization as well as technical measures such as network segmentation.

 Transmitters with an Ex de approval may not be connected via the service interface (CDI-RJ45)!

Order code for "Approval transmitter + sensor", options (Ex de): BA, BB, C1, C2, GA, GB, MA, MB, NA, NB

 The device can be integrated in a ring topology. The device is integrated via the terminal connection for signal transmission (output 1) and the connection to the service interface (CDI-RJ45) .

Input

Measured variable

Direct measured variables

- Mass flow
- Density
- Temperature

Calculated measured variables

- Volume flow
- Corrected volume flow
- Reference density

Measuring range

Measuring range for liquids

DN Measuring device		DN Compatible pipe diameter		Measuring range full scale values $\dot{m}_{\min(F)}$ to $\dot{m}_{\max(F)}$	
[mm]	[in]	[mm]	[in]	[kg/h]	[lb/min]
25	1	25/40	1/1½	0 to 20 000	0 to 735
50	2	50/80	2/3	0 to 80 000	0 to 2 940
80	3	80/100	3/4	0 to 200 000	0 to 7 350
100	4	100/150	4/6	0 to 550 000	0 to 20 210



Measuring range for gases

The full scale value depends on the density and the sound velocity of the gas used and can be calculated with the formula below:

$$\dot{m}_{\max(G)} = \text{minimum} (\dot{m}_{\max(F)} \cdot \rho_G : x ; \rho_G \cdot c_G \cdot \pi/2 \cdot (d_i)^2 \cdot 3600)$$

$\dot{m}_{\max(G)}$	Maximum full scale value for gas [kg/h]
$\dot{m}_{\max(F)}$	Maximum full scale value for liquid [kg/h]
$\dot{m}_{\max(G)} < \dot{m}_{\max(F)}$	$\dot{m}_{\max(G)}$ can never be greater than $\dot{m}_{\max(F)}$
ρ_G	Gas density in [kg/m ³] at operating conditions
x	Constant dependent on nominal diameter
c_G	Sound velocity (gas) [m/s]
d_i	Measuring tube internal diameter [m]

DN		x
[mm]	[in]	[kg/m ³]
25	1	100
50	2	100
80	3	120
100	4	200

 To calculate the measuring range, use the *Applicator* sizing tool →  105



Calculation example for gas

- Sensor: Promass Q, DN 50
- Gas: Air with a density of 60.3 kg/m³ (at 20 °C and 50 bar)
- Measuring range (liquid): 80 000 kg/h
- $x = 100$ kg/m³ (for Promass Q, DN 50)

Maximum possible full scale value:

$$\dot{m}_{\max(G)} = \dot{m}_{\max(F)} \cdot \rho_G : x = 80\,000 \text{ kg/h} \cdot 60.3 \text{ kg/m}^3 : 100 \text{ kg/m}^3 = 48\,240 \text{ kg/h}$$

Recommended measuring range

 Flow limit →  60

Operable flow range

Over 1000 : 1.

Flow rates above the preset full scale value do not override the electronics unit, with the result that the totalizer values are registered correctly.

Input signal

Output and input variants

→  13

External measured values

 Various pressure and temperature measuring devices can be ordered from Endress+Hauser: see "Accessories" section →  105

It is recommended to read in external measured values to calculate the corrected volume flow.

HART protocol

The measured values are written from the automation system to the measuring device via the HART protocol. The pressure transmitter must support the following protocol-specific functions:

- HART protocol
- Burst mode

Current input

The measured values are written from the automation system to the measuring device via the current input →  11.

Digital communication

The measured values can be written from the automation system to the measuring via:

- FOUNDATION Fieldbus
- PROFIBUS DP
- PROFIBUS PA
- Modbus RS485
- EtherNet/IP
- PROFINET

Current input 0/4 to 20 mA

Current input	0/4 to 20 mA (active/passive)
Current span	<ul style="list-style-type: none"> ▪ 4 to 20 mA (active) ▪ 0/4 to 20 mA (passive)
Resolution	1 µA
Voltage drop	Typically: 0.6 to 2 V for 3.6 to 22 mA (passive)
Maximum input voltage	≤ 30 V (passive)
Open-circuit voltage	≤ 28.8 V (active)
Possible input variables	<ul style="list-style-type: none"> ▪ Pressure ▪ Temperature ▪ Density

Status input

Maximum input values	<ul style="list-style-type: none"> ▪ DC -3 to 30 V ▪ If status input is active (ON): R_i >3 kΩ
Response time	Configurable: 5 to 200 ms

Input signal level	<ul style="list-style-type: none">▪ Low signal: DC -3 to +5 V▪ High signal: DC 12 to 30 V
Assignable functions	<ul style="list-style-type: none">▪ Off▪ Reset the individual totalizers separately▪ Reset all totalizers▪ Flow override

Output

Output and input variants

Depending on the option selected for output/input 1, different options are available for the other outputs and inputs. Only one option can be selected for each output/input 1 to 3. The following tables must be read vertically (↓).

Example: If the option BA "4–20 mA HART" was selected for output/input 1, one of the options A, B, D, E, F, H, I or J is available for output 2 and one of the options A, B, D, E, F, H, I or J is available for output 3.

Output/input 1 and options for output/input 2

 Options for output/input 3

Order code for "Output; input 1" (020) →	Possible options										
Current output 4 to 20 mA HART	BA										
Current output 4 to 20 mA HART Ex i passive	↓	CA									
Current output 4 to 20 mA HART Ex i active		↓	CC								
FOUNDATION Fieldbus			↓	SA							
FOUNDATION Fieldbus Ex i				↓	TA						
PROFIBUS DP					↓	LA					
PROFIBUS PA						↓	GA				
PROFIBUS PA Ex i							↓	HA			
Modbus RS485								↓	MA		
EtherNet/IP 2-port switch integrated									↓	NA	
PROFINET 2-port switch integrated										↓	RA
Order code for "Output; input 2" (021) →	↓	↓	↓	↓	↓	↓	↓	↓	↓	↓	↓
Not assigned	A	A	A	A	A	A	A	A	A	A	A
Current output 4 to 20 mA	B			B		B	B		B	B	B
Current output 4 to 20 mA Ex i passive		C	C		C			C			
User-configurable input/output ¹⁾	D			D		D	D		D	D	D
Pulse/frequency/switch output	E			E		E	E		E	E	E
Double pulse output ²⁾	F								F		
Pulse/frequency/switch output Ex i passive		G	G		G			G			
Relay output	H			H		H	H		H	H	H
Current input 0/4 to 20 mA	I			I		I	I		I	I	I
Status input	J			J		J	J		J	J	J

- 1) A specific input or output can be assigned to a user-configurable input/output →  20.
- 2) If double pulse output (F) is selected for output/input 2 (021), only the double pulse output (F) option is available for selection for output/input 3 (022).

Output/input 1 and options for output/input 3

 Options for output/input 2 →  13

Order code for "Output; input 1" (020) →	Possible options										
Current output 4 to 20 mA HART	BA										
Current output 4 to 20 mA HART Ex i passive	↓	CA									
Current output 4 to 20 mA HART Ex i active		↓	CC								
FOUNDATION Fieldbus			↓	SA							
FOUNDATION Fieldbus Ex i				↓	TA						
PROFIBUS DP					↓	LA					
PROFIBUS PA						↓	GA				
PROFIBUS PA Ex i							↓	HA			
Modbus RS485								↓	MA		
EtherNet/IP 2-port switch integrated									↓	NA	
PROFINET 2-port switch integrated										↓	RA
Order code for "Output; input 3" (022) →	↓	↓	↓	↓	↓	↓	↓	↓	↓	↓	↓
Not assigned	A	A	A	A	A	A	A	A	A	A	A
Current output 4 to 20 mA	B						B			B	B
Current output 4 to 20 mA Ex i passive		C	C								
User-configurable input/output	D						D			D	D
Pulse/frequency/switch output	E						E			E	E
Double pulse output (slave) ¹⁾	F									F	
Pulse/frequency/switch output Ex i passive		G	G								
Relay output	H						H			H	H
Current input 0/4 to 20 mA	I						I			I	I
Status input	J						J			J	J

1) If double pulse output (F) is selected for output/input 2 (021), only the double pulse output (F) option is available for output/input 3 (022).

Output signal

Current output 4 to 20 mA HART

Order code	"Output; input 1" (20): Option BA: current output 4 to 20 mA HART
Signal mode	Can be set to: <ul style="list-style-type: none"> ■ Active ■ Passive
Current range	Can be set to: <ul style="list-style-type: none"> ■ 4 to 20 mA NAMUR ■ 4 to 20 mA US ■ 4 to 20 mA ■ 0 to 20 mA (only if the signal mode is active) ■ Fixed current
Open-circuit voltage	DC 28.8 V (active)
Maximum input voltage	DC 30 V (passive)
Load	250 to 700 Ω
Resolution	0.38 μA
Damping	Configurable: 0 to 999.9 s
Assignable measured variables	<ul style="list-style-type: none"> ■ Mass flow ■ Volume flow ■ Corrected volume flow ■ Density ■ Reference density ■ Temperature ■ Electronics temperature ■ Oscillation frequency 0 ■ Oscillation damping 0 ■ Signal asymmetry ■ Exciter current 0 <p> The range of options increases if the measuring device has one or more application packages.</p>

Current output 4 to 20 mA HART Ex i

Order code	"Output; input 1" (20) choose from: <ul style="list-style-type: none"> ■ Option CA: current output 4 to 20 mA HART Ex i passive ■ Option CC: current output 4 to 20 mA HART Ex i active
Signal mode	Depends on the selected order version.
Current range	Can be set to: <ul style="list-style-type: none"> ■ 4 to 20 mA NAMUR ■ 4 to 20 mA US ■ 4 to 20 mA ■ 0 to 20 mA (only if the signal mode is active) ■ Fixed current
Open-circuit voltage	DC 21.8 V (active)
Maximum input voltage	DC 30 V (passive)
Load	<ul style="list-style-type: none"> ■ 250 to 400 Ω (active) ■ 250 to 700 Ω (passive)
Resolution	0.38 μA

Damping	Configurable: 0 to 999.9 s
Assignable measured variables	<ul style="list-style-type: none"> ▪ Mass flow ▪ Volume flow ▪ Corrected volume flow ▪ Density ▪ Reference density ▪ Temperature ▪ Electronics temperature ▪ Oscillation frequency 0 ▪ Oscillation damping 0 ▪ Signal asymmetry ▪ Exciter current 0 <p> The range of options increases if the measuring device has one or more application packages.</p>

FOUNDATION Fieldbus

FOUNDATION Fieldbus	H1, IEC 61158-2, galvanically isolated
Data transfer	31.25 kbit/s
Current consumption	10 mA
Permitted supply voltage	9 to 32 V
Bus connection	With integrated reverse polarity protection

PROFIBUS DP

Signal encoding	NRZ code
Data transfer	9.6 kBaud...12 MBaud

PROFIBUS PA

PROFIBUS PA	In accordance with EN 50170 Volume 2, IEC 61158-2 (MBP), galvanically isolated
Data transmission	31.25 kbit/s
Current consumption	10 mA
Permitted supply voltage	9 to 32 V
Bus connection	With integrated reverse polarity protection

Modbus RS485

Physical interface	RS485 in accordance with EIA/TIA-485 standard
Terminating resistor	Integrated, can be activated via DIP switches

EtherNet/IP

Standards	In accordance with IEEE 802.3
------------------	-------------------------------

PROFINET

Standards	In accordance with IEEE 802.3
------------------	-------------------------------

Current output 4 to 20 mA

Order code	"Output; input 2" (21), "Output; input 3" (022): Option B: current output 4 to 20 mA
Signal mode	Can be set to: <ul style="list-style-type: none"> ■ Active ■ Passive
Current span	Can be set to: <ul style="list-style-type: none"> ■ 4 to 20 mA NAMUR ■ 4 to 20 mA US ■ 4 to 20 mA ■ 0 to 20 mA (only if the signal mode is active) ■ Fixed current
Maximum output values	22.5 mA
Open-circuit voltage	DC 28.8 V (active)
Maximum input voltage	DC 30 V (passive)
Load	0 to 700 Ω
Resolution	0.38 μA
Damping	Configurable: 0 to 999.9 s
Assignable measured variables	<ul style="list-style-type: none"> ■ Mass flow ■ Volume flow ■ Corrected volume flow ■ Density ■ Reference density ■ Temperature ■ Electronics temperature ■ Oscillation frequency 0 ■ Oscillation damping 0 ■ Signal asymmetry ■ Exciter current 0 <p> The range of options increases if the measuring device has one or more application packages.</p>



Current output 4 to 20 mA Ex i passive

Order code	"Output; input 2" (21), "Output; input 3" (022): Option C: current output 4 to 20 mA Ex i passive
Signal mode	Passive
Current span	Can be set to: <ul style="list-style-type: none"> ■ 4 to 20 mA NAMUR ■ 4 to 20 mA US ■ 4 to 20 mA ■ Fixed current
Maximum output values	22.5 mA
Maximum input voltage	DC 30 V
Load	0 to 700 Ω
Resolution	0.38 μA

Damping	Configurable: 0 to 999 s
Assignable measured variables	<ul style="list-style-type: none"> ▪ Mass flow ▪ Volume flow ▪ Corrected volume flow ▪ Density ▪ Reference density ▪ Temperature ▪ Electronics temperature ▪ Oscillation frequency 0 ▪ Oscillation damping 0 ▪ Signal asymmetry ▪ Exciter current 0 <p> The range of options increases if the measuring device has one or more application packages.</p>

Pulse/frequency/switch output

Function	Can be set to pulse, frequency or switch output
Version	Open collector Can be set to: <ul style="list-style-type: none"> ▪ Active ▪ Passive ▪ Passive NAMUR <p> Ex-i, passive</p>
Maximum input values	DC 30 V, 250 mA (passive)
Open-circuit voltage	DC 28.8 V (active)
Voltage drop	For 22.5 mA: ≤ DC 2 V
Pulse output	
Maximum input values	DC 30 V, 250 mA (passive)
Maximum output current	22.5 mA (active)
Open-circuit voltage	DC 28.8 V (active)
Pulse width	Configurable: 0.05 to 2 000 ms
Maximum pulse rate	10 000 Impulse/s
Pulse value	Adjustable
Assignable measured variables	<ul style="list-style-type: none"> ▪ Mass flow ▪ Volume flow ▪ Corrected volume flow
Frequency output	
Maximum input values	DC 30 V, 250 mA (passive)
Maximum output current	22.5 mA (active)
Open-circuit voltage	DC 28.8 V (active)
Output frequency	Adjustable: end value frequency 2 to 10 000 Hz ($f_{\max} = 12\,500$ Hz)
Damping	Configurable: 0 to 999.9 s
Pulse/pause ratio	1:1

Assignable measured variables	<ul style="list-style-type: none"> ▪ Mass flow ▪ Volume flow ▪ Corrected volume flow ▪ Density ▪ Reference density ▪ Temperature ▪ Electronics temperature ▪ Oscillation frequency 0 ▪ Oscillation damping 0 ▪ Signal asymmetry ▪ Exciter current 0 <p> The range of options increases if the measuring device has one or more application packages.</p>
Switch output	
Maximum input values	DC 30 V, 250 mA (passive)
Open-circuit voltage	DC 28.8 V (active)
Switching behavior	Binary, conductive or non-conductive
Switching delay	Configurable: 0 to 100 s
Number of switching cycles	Unlimited
Assignable functions	<ul style="list-style-type: none"> ▪ Off ▪ On ▪ Diagnostic behavior ▪ Limit value <ul style="list-style-type: none"> ▪ Mass flow ▪ Volume flow ▪ Corrected volume flow ▪ Density ▪ Reference density ▪ Temperature ▪ Totalizer 1-3 ▪ Flow direction monitoring ▪ Status <ul style="list-style-type: none"> ▪ Partially filled pipe detection ▪ Low flow cut off <p> The range of options increases if the measuring device has one or more application packages.</p>

Double pulse output

Function	Double pulse
Version	Open collector Can be set to: <ul style="list-style-type: none"> ▪ Active ▪ Passive ▪ Passive NAMUR
Maximum input values	DC 30 V, 250 mA (passive)
Open-circuit voltage	DC 28.8 V (active)
Voltage drop	For 22.5 mA: ≤ DC 2 V
Output frequency	Configurable: 0 to 1000 Hz
Damping	Configurable: 0 to 999 s

Pulse/pause ratio	1:1
Assignable measured variables	<ul style="list-style-type: none"> ▪ Mass flow ▪ Volume flow ▪ Corrected volume flow ▪ Density ▪ Reference density ▪ Temperature <p> The range of options increases if the measuring device has one or more application packages.</p>

Relay output

Function	Switch output
Version	Relay output, galvanically isolated
Switching behavior	Can be set to: <ul style="list-style-type: none"> ▪ NO (normally open), factory setting ▪ NC (normally closed)
Maximum switching capacity (passive)	<ul style="list-style-type: none"> ▪ DC 30 V, 0.1 A ▪ AC 30 V, 0.5 A
Assignable functions	<ul style="list-style-type: none"> ▪ Off ▪ On ▪ Diagnostic behavior ▪ Limit value <ul style="list-style-type: none"> ▪ Mass flow ▪ Volume flow ▪ Corrected volume flow ▪ Density ▪ Reference density ▪ Temperature ▪ Totalizer 1-3 ▪ Flow direction monitoring ▪ Status <ul style="list-style-type: none"> ▪ Partially filled pipe detection ▪ Low flow cut off <p> The range of options increases if the measuring device has one or more application packages.</p>

User-configurable input/output

One specific input or output is assigned to a user-configurable input/output (configurable I/O) during device commissioning.

The following inputs and outputs are available for assignment:

- Choice of current output: 4 to 20 mA (active), 0/4 to 20 mA (passive)
- Pulse/frequency/switch output
- Choice of current input: 4 to 20 mA (active), 0/4 to 20 mA (passive)
- Status input

The technical values correspond to those of the inputs and outputs described in this section.

Signal on alarm

Depending on the interface, failure information is displayed as follows:

HART current output

Device diagnostics	Device condition can be read out via HART Command 48
---------------------------	--

PROFIBUS PA

Status and alarm messages	Diagnostics in accordance with PROFIBUS PA Profile 3.02
Failure current FDE (Fault Disconnection Electronic)	0 mA

PROFIBUS DP

Status and alarm messages	Diagnostics in accordance with PROFIBUS PA Profile 3.02
----------------------------------	---

EtherNet/IP

Device diagnostics	Device condition can be read out in Input Assembly
---------------------------	--

PROFINET

Device diagnostics	According to "Application Layer protocol for decentralized periphery", Version 2.3
---------------------------	--

FOUNDATION Fieldbus

Status and alarm messages	Diagnostics in accordance with FF-891
Failure current FDE (Fault Disconnection Electronic)	0 mA

Modbus RS485

Failure mode	Choose from: <ul style="list-style-type: none"> ▪ NaN value instead of current value ▪ Last valid value
---------------------	---

Current output 0/4 to 20 mA

4 to 20 mA

Failure mode	Choose from: <ul style="list-style-type: none"> ▪ 4 to 20 mA in accordance with NAMUR recommendation NE 43 ▪ 4 to 20 mA in accordance with US ▪ Min. value: 3.59 mA ▪ Max. value: 22.5 mA ▪ Freely definable value between: 3.59 to 22.5 mA ▪ Actual value ▪ Last valid value
---------------------	--

0 to 20 mA

Failure mode	Choose from: <ul style="list-style-type: none"> ▪ Maximum alarm: 22 mA ▪ Freely definable value between: 0 to 20.5 mA
---------------------	---

Pulse/frequency/switch output

Pulse output	
Failure mode	Choose from: <ul style="list-style-type: none"> ▪ Actual value ▪ No pulses
Frequency output	
Failure mode	Choose from: <ul style="list-style-type: none"> ▪ Actual value ▪ 0 Hz ▪ Defined value (f_{\max} 2 to 12 500 Hz)
Switch output	
Failure mode	Choose from: <ul style="list-style-type: none"> ▪ Current status ▪ Open ▪ Closed

Relay output

Failure mode	Choose from: <ul style="list-style-type: none"> ▪ Current status ▪ Open ▪ Closed
--------------	---

Local display

Plain text display	With information on cause and remedial measures
Backlight	Red backlighting indicates a device error.



Status signal as per NAMUR recommendation NE 107

Interface/protocol

- Via digital communication:
 - HART protocol
 - FOUNDATION Fieldbus
 - PROFIBUS PA
 - PROFIBUS DP
 - Modbus RS485
 - EtherNet/IP
 - PROFINET
- Via service interface
 - CDI-RJ45 service interface
 - WLAN interface

Plain text display	With information on cause and remedial measures
--------------------	---



Additional information on remote operation → 86

Web browser

Plain text display	With information on cause and remedial measures
--------------------	---

Intrinsically safe values

Order code for "Output; input 1"	Output type	Intrinsically safe values "Output; input 1"	
		26 (+)	27 (-)
Option CA	Current output 4 to 20 mA HART Ex i passive	$U_i = 30 \text{ V}$ $I_i = 100 \text{ mA}$ $P_i = 1.25 \text{ W}$ $L_i = 0 \text{ } \mu\text{H}$ $C_i = 6 \text{ nF}$	
Option CC	Current output 4 to 20 mA HART Ex i active	Ex ia ¹⁾ $U_o = 21.8 \text{ V}$ $I_o = 90 \text{ mA}$ $P_o = 491 \text{ mW}$ $L_o = 4.1 \text{ mH (IIC)}/15 \text{ mH (IIB)}$ $C_o = 160 \text{ nF (IIC)}/1160 \text{ nF (IIB)}$ $U_i = 30 \text{ V}$ $I_i = 10 \text{ mA}$ $P_i = 0.3 \text{ W}$ $L_i = 5 \text{ } \mu\text{H}$ $C_i = 6 \text{ nF}$	Ex ic ²⁾ $U_o = 21.8 \text{ V}$ $I_o = 90 \text{ mA}$ $P_o = 491 \text{ mW}$ $L_o = 9 \text{ mH (IIC)}/39 \text{ mH (IIB)}$ $C_o = 600 \text{ nF (IIC)}/4000 \text{ nF (IIB)}$
Option HA	PROFIBUS PA Ex i (FISCO Field Device)	Ex ia ³⁾ $U_i = 30 \text{ V}$ $I_i = 570 \text{ mA}$ $P_i = 8.5 \text{ W}$ $L_i = 10 \text{ } \mu\text{H}$ $C_i = 5 \text{ nF}$	Ex ic ⁴⁾ $U_i = 32 \text{ V}$ $I_i = 570 \text{ mA}$ $P_i = 8.5 \text{ W}$ $L_i = 10 \text{ } \mu\text{H}$ $C_i = 5 \text{ nF}$
Option TA	FOUNDATION Fieldbus Ex i	Ex ia ³⁾ $U_i = 30 \text{ V}$ $I_i = 570 \text{ mA}$ $P_i = 8.5 \text{ W}$ $L_i = 10 \text{ } \mu\text{H}$ $C_i = 5 \text{ nF}$	Ex ic ⁴⁾ $U_i = 32 \text{ V}$ $I_i = 570 \text{ mA}$ $P_i = 8.5 \text{ W}$ $L_i = 10 \text{ } \mu\text{H}$ $C_i = 5 \text{ nF}$

- 1) Only available for the Zone 1; Class I, Division 1 version
- 2) Only available for the Zone 2; Class I, Division 2 version transmitter
- 3) Only available for the Zone 1; Class I, Division 1 version
- 4) Only available for the Zone 2; Class I, Division 2 version transmitter

Order code for "Output; input 2"; "Output; input 3"	Output type	Intrinsically safe values or NIFW values			
		Output; input 2		Output; input 3	
		24 (+)	25 (-)	22 (+)	23 (-)
Option C	Current output 4 to 20 mA Ex i passive	$U_i = 30 \text{ V}$ $I_i = 100 \text{ mA}$ $P_i = 1.25 \text{ W}$ $L_i = 0$ $C_i = 0$			
Option G	Pulse/frequency/switch output Ex i passive	$U_i = 30 \text{ V}$ $I_i = 100 \text{ mA}$ $P_i = 1.25 \text{ W}$ $L_i = 0$ $C_i = 0$			

Low flow cut off

The switch points for low flow cut off are user-selectable.

Galvanic isolation

The outputs are galvanically isolated from one another and from earth (PE).

Protocol-specific data

HART



Manufacturer ID	0x11
Device type ID	0x3B
HART protocol revision	7
Device description files (DTM, DD)	Information and files under: www.endress.com
HART load	Min. 250 Ω
System integration	Information on system integration: Operating Instructions → 106. <ul style="list-style-type: none"> ▪ Measured variables via HART protocol ▪ Burst Mode functionality

FOUNDATION Fieldbus

Manufacturer ID	0x452B48 (hex)
Ident number	0x103B (hex)
Device revision	1
DD revision	Information and files under:
CFF revision	<ul style="list-style-type: none"> ▪ www.endress.com ▪ www.fieldbus.org
Interoperability Test Kit (ITK)	Version 6.2.0
ITK Test Campaign Number	Information: <ul style="list-style-type: none"> ▪ www.endress.com ▪ www.fieldbus.org
Link Master capability (LAS)	Yes
Choice of "Link Master" and "Basic Device"	Yes Factory setting: Basic Device
Node address	Factory setting: 247 (0xF7)
Supported functions	The following methods are supported: <ul style="list-style-type: none"> ▪ Restart ▪ ENP Restart ▪ Diagnostic ▪ Set to OOS ▪ Set to AUTO ▪ Read trend data ▪ Read event logbook
Virtual Communication Relationships (VCRs)	
Number of VCRs	44
Number of link objects in VFD	50
Permanent entries	1
Client VCRs	0
Server VCRs	10
Source VCRs	43
Sink VCRs	0
Subscriber VCRs	43
Publisher VCRs	43
Device Link Capabilities	
Slot time	4
Min. delay between PDU	8



Max. response delay	16
System integration	Information regarding system integration: Operating Instructions →  106. <ul style="list-style-type: none"> ▪ Cyclic data transmission ▪ Description of the modules ▪ Execution times ▪ Methods

PROFIBUS DP

Manufacturer ID	0x11
Ident number	0x156F
Profile version	3.02
Device description files (GSD, DTM, DD)	Information and files under: <ul style="list-style-type: none"> ▪ www.endress.com On the product page for the device: Documents/Software → Device drivers ▪ www.profibus.org
Supported functions	<ul style="list-style-type: none"> ▪ Identification & Maintenance Simplest device identification on the part of the control system and nameplate ▪ PROFIBUS upload/download Reading and writing parameters is up to ten times faster with PROFIBUS upload/download ▪ Condensed status Simplest and self-explanatory diagnostic information by categorizing diagnostic messages that occur
Configuration of the device address	<ul style="list-style-type: none"> ▪ DIP switches on the I/O electronics module ▪ Via operating tools (e.g. FieldCare)
Compatibility with earlier model	<p>If the device is replaced, the measuring device Promass 300 supports the compatibility of the cyclic data with previous models. It is not necessary to adjust the engineering parameters of the PROFIBUS network with the Promass 300 GSD file.</p> <p>Previous model: Promass 83 PROFIBUS DP</p> <ul style="list-style-type: none"> ▪ ID No.: 1529 (hex) ▪ Extended GSD file: EH3x1529.gsd ▪ Standard GSD file: EH3_1529.gsd <p> Description of the function scope of compatibility: Operating Instructions →  106.</p>
System integration	Information regarding system integration: Operating Instructions →  106. <ul style="list-style-type: none"> ▪ Cyclic data transmission ▪ Block model ▪ Description of the modules





PROFIBUS PA

Manufacturer ID	0x11
Ident number	0x156D
Profile version	3.02
Device description files (GSD, DTM, DD)	Information and files under: <ul style="list-style-type: none"> ▪ www.endress.com ▪ www.profibus.org

Supported functions	<ul style="list-style-type: none"> ▪ Identification & Maintenance Simplest device identification on the part of the control system and nameplate ▪ PROFIBUS upload/download Reading and writing parameters is up to ten times faster with PROFIBUS upload/download ▪ Condensed status Simplest and self-explanatory diagnostic information by categorizing diagnostic messages that occur
Configuration of the device address	<ul style="list-style-type: none"> ▪ DIP switches on the I/O electronics module ▪ Local display ▪ Via operating tools (e.g. FieldCare)
Compatibility with earlier model	<p>If the device is replaced, the measuring device Promass 300 supports the compatibility of the cyclic data with previous models. It is not necessary to adjust the engineering parameters of the PROFIBUS network with the Promass 300 GSD file.</p> <p>Earlier models:</p> <ul style="list-style-type: none"> ▪ Promass 80 PROFIBUS PA <ul style="list-style-type: none"> ▪ ID No.: 1528 (hex) ▪ Extended GSD file: EH3x1528.gsd ▪ Standard GSD file: EH3_1528.gsd ▪ Promass 83 PROFIBUS PA <ul style="list-style-type: none"> ▪ ID No.: 152A (hex) ▪ Extended GSD file: EH3x152A.gsd ▪ Standard GSD file: EH3_152A.gsd <p> Description of the function scope of compatibility: Operating Instructions →  106.</p>
System integration	<p>Information regarding system integration: Operating Instructions →  106.</p> <ul style="list-style-type: none"> ▪ Cyclic data transmission ▪ Block model ▪ Description of the modules

Modbus RS485

Protocol	Modbus Applications Protocol Specification V1.1
Response times	<ul style="list-style-type: none"> ▪ Direct data access: typically 25 to 50 ms ▪ Auto-scan buffer (data range): typically 3 to 5 ms
Device type	Slave
Slave address range	1 to 247
Broadcast address range	0
Function codes	<ul style="list-style-type: none"> ▪ 03: Read holding register ▪ 04: Read input register ▪ 06: Write single registers ▪ 08: Diagnostics ▪ 16: Write multiple registers ▪ 23: Read/write multiple registers
Broadcast messages	<p>Supported by the following function codes:</p> <ul style="list-style-type: none"> ▪ 06: Write single registers ▪ 16: Write multiple registers ▪ 23: Read/write multiple registers
Supported baud rate	<ul style="list-style-type: none"> ▪ 1 200 BAUD ▪ 2 400 BAUD ▪ 4 800 BAUD ▪ 9 600 BAUD ▪ 19 200 BAUD ▪ 38 400 BAUD ▪ 57 600 BAUD ▪ 115 200 BAUD
Data transfer mode	<ul style="list-style-type: none"> ▪ ASCII ▪ RTU

Data access	Each device parameter can be accessed via Modbus RS485.  For Modbus register information
Compatibility with earlier model	If the device is replaced, the measuring device Promass 300 supports the compatibility of the Modbus registers for the process variables and the diagnostic information with the previous model Promass 83. It is not necessary to change the engineering parameters in the automation system.  Description of the function scope of compatibility: Operating Instructions →  106.
System integration	Information on system integration: Operating Instructions →  106. <ul style="list-style-type: none"> ▪ Modbus RS485 information ▪ Function codes ▪ Register information ▪ Response time ▪ Modbus data map

EtherNet/IP

Protocol	<ul style="list-style-type: none"> ▪ The CIP Networks Library Volume 1: Common Industrial Protocol ▪ The CIP Networks Library Volume 2: EtherNet/IP Adaptation of CIP
Communication type	<ul style="list-style-type: none"> ▪ 10Base-T ▪ 100Base-TX
Device profile	Generic device (product type: 0x2B)
Manufacturer ID	0x11
Device type ID	0x103B
Baud rates	Automatic ¹⁹ / ₁₀₀ Mbit with half-duplex and full-duplex detection
Polarity	Auto-polarity for automatic correction of crossed TxD and RxD pairs
Supported CIP connections	Max. 3 connections
Explicit connections	Max. 6 connections
I/O connections	Max. 6 connections (scanner)
Configuration options for measuring device	<ul style="list-style-type: none"> ▪ DIP switches on the electronics module for IP addressing ▪ Manufacturer-specific software (FieldCare) ▪ Add-on Profile Level 3 for Rockwell Automation control systems ▪ Web browser ▪ Electronic Data Sheet (EDS) integrated in the measuring device
Configuration of the EtherNet interface	<ul style="list-style-type: none"> ▪ Speed: 10 MBit, 100 MBit, auto (factory setting) ▪ Duplex: half-duplex, full-duplex, auto (factory setting)
Configuration of the device address	<ul style="list-style-type: none"> ▪ DIP switches on the electronics module for IP addressing (last octet) ▪ DHCP ▪ Manufacturer-specific software (FieldCare) ▪ Add-on Profile Level 3 for Rockwell Automation control systems ▪ Web browser ▪ EtherNet/IP tools, e.g. RSLinx (Rockwell Automation)
Device Level Ring (DLR)	Yes
System integration	Information regarding system integration: Operating Instructions →  106. <ul style="list-style-type: none"> ▪ Cyclic data transmission ▪ Block model ▪ Input and output groups

PROFINET

Protocol	Application layer protocol for decentral device periphery and distributed automation, Version 2.3
Communication type	100 MBit/s

Conformity class	Conformance Class B
Netload Class	Netload Class II
Baud rates	Automatic 100 Mbit/s with full-duplex detection
Cycle times	From 8 ms
Polarity	Auto-polarity for automatic correction of crossed TxD and RxD pairs
Media Redundancy Protocol (MRP)	Yes
System redundancy support	System redundancy S2 (2 AR with 1 NAP)
Device profile	Application interface identifier 0xF600 Generic device
Manufacturer ID	0x11
Device type ID	0x843B
Device description files (GSD, DTM, DD)	Information and files under: <ul style="list-style-type: none"> ▪ www.endress.com ▪ On the product page for the device: Documents/Software → Device drivers ▪ www.profibus.org
Supported connections	<ul style="list-style-type: none"> ▪ 2 x AR (IO Controller AR) ▪ 1 x AR (IO-Supervisor Device AR connection allowed) ▪ 1 x Input CR (Communication Relation) ▪ 1 x Output CR (Communication Relation) ▪ 1 x Alarm CR (Communication Relation)
Configuration options for measuring device	<ul style="list-style-type: none"> ▪ DIP switches on the electronics module, for device name assignment (last part) ▪ Manufacturer-specific software (FieldCare, DeviceCare) ▪ Web browser ▪ Device master file (GSD), can be read out via the integrated Web server of the measuring device
Configuration of the device name	<ul style="list-style-type: none"> ▪ DIP switches on the electronics module, for device name assignment (last part) ▪ DCP protocol ▪ Process Device Manager (PDM) ▪ Integrated Web server
Supported functions	<ul style="list-style-type: none"> ▪ Identification & Maintenance Simple device identification via: <ul style="list-style-type: none"> ▪ Control system ▪ Nameplate ▪ Measured value status The process variables are communicated with a measured value status ▪ Blinking feature via the onsite display for simple device identification and assignment ▪ Device operation via operating tools (e.g. FieldCare, DeviceCare, SIMATIC PDM)
System integration	Information regarding system integration: Operating Instructions →  106. <ul style="list-style-type: none"> ▪ Cyclic data transmission ▪ Overview and description of the modules ▪ Status coding ▪ Startup configuration ▪ Factory setting

Power supply

Terminal assignment

Transmitter: supply voltage, input/outputs

HART

Supply voltage		Input/output 1		Input/output 2		Input/output 3	
1 (+)	2 (-)	26 (+)	27 (-)	24 (+)	25 (-)	22 (+)	23 (-)
The terminal assignment depends on the specific device version ordered → 13.							

FOUNDATION Fieldbus

Supply voltage		Input/output 1		Input/output 2		Input/output 3	
1 (+)	2 (-)	26 (A)	27 (B)	24 (+)	25 (-)	22 (+)	23 (-)
The terminal assignment depends on the specific device version ordered → 13.							

PROFIBUS PA

Supply voltage		Input/output 1		Input/output 2		Input/output 3	
1 (+)	2 (-)	26 (B)	27 (A)	24 (+)	25 (-)	22 (+)	23 (-)
The terminal assignment depends on the specific device version ordered → 13.							

PROFIBUS DP

Supply voltage		Input/output 1		Input/output 2		Input/output 3	
1 (+)	2 (-)	26 (B)	27 (A)	24 (+)	25 (-)	22 (+)	23 (-)
The terminal assignment depends on the specific device version ordered → 13.							

Modbus RS485

Supply voltage		Input/output 1		Input/output 2		Input/output 3	
1 (+)	2 (-)	26 (B)	27 (A)	24 (+)	25 (-)	22 (+)	23 (-)
The terminal assignment depends on the specific device version ordered → 13.							

PROFINET

Supply voltage		Input/output 1		Input/output 2		Input/output 3	
1 (+)	2 (-)	PROFINET (RJ45 connector)		24 (+)	25 (-)	22 (+)	23 (-)
The terminal assignment depends on the specific device version ordered → 13.							

EtherNet/IP

Supply voltage		Input/output 1		Input/output 2		Input/output 3	
1 (+)	2 (-)	EtherNet/IP (RJ45 connector)		24 (+)	25 (-)	22 (+)	23 (-)
The terminal assignment depends on the specific device version ordered → 13.							

 Terminal assignment of the remote display and operating module → 33.

Device plugs available

 Device plugs may not be used in hazardous areas!

Device plugs for fieldbus systems:

Order code for "Input; output 1"

- Option SA "FOUNDATION Fieldbus" → 31
- Option GA "PROFIBUS PA" → 31
- Option NA "EtherNet/IP" → 31
- Option RA "PROFINET" → 31

Device plug for connecting to the service interface:

Order code for "Accessory mounted"

option NB, adapter RJ45 M12 (service interface) → 43

Order code for "Input; output 1", option SA "FOUNDATION Fieldbus"

Order code for "Electrical connection"	Cable entry/connection → 32	
	2	3
M, 3, 4, 5	7/8" connector	-

Order code for "Input; output 1", option GA "PROFIBUS PA"

Order code for "Electrical connection"	Cable entry/connection → 32	
	2	3
L, N, P, U	Connector M12 × 1	-

Order code for "Input; output 1", option NA "EtherNet/IP"

Order code for "Electrical connection"	Cable entry/connection → 32	
	2	3
L, N, P, U	Connector M12 × 1	-
R ^{1) 2)} , S ^{1) 2)} , T ^{1) 2)} , V ^{1) 2)}	Connector M12 × 1	Connector M12 × 1

- 1) Cannot be combined with an external WLAN antenna (order code for "Enclosed accessories", option P8) of an RJ45 M12 adapter for the service interface (order code for "Accessories mounted", option NB) or of the remote display and operating module DKX001
- 2) Suitable for integrating the device in a ring topology.

Order code for "Input; output 1", option RA "PROFINET"

Order code for "Electrical connection"	Cable entry/connection → 32	
	2	3
L, N, P, U	Connector M12 × 1	-
R ^{1) 2)} , S ^{1) 2)} , T ^{1) 2)} , V ^{1) 2)}	Connector M12 × 1	Connector M12 × 1

- 1) Cannot be combined with an external WLAN antenna (order code for "Enclosed accessories", option P8) of an RJ45 M12 adapter for the service interface (order code for "Accessories mounted", option NB) or of the remote display and operating module DKX001.
- 2) Suitable for integrating the device in a ring topology.

Order code for "Accessory mounted", option NB "Adapter RJ45 M12 (service interface)"

Order code "Accessory mounted"	Cable entry/coupling → 32	
	Cable entry 2	Cable entry 3
NB	Plug M12 × 1	-

Supply voltage	Order code for "Power supply"	Terminal voltage		Frequency range
	Option D		DC 24 V	±20%
Option E		AC 100 to 240 V	–15 to +10%	50/60 Hz
Option I		DC 24 V	±20%	–
		AC 100 to 240 V	–15 to +10%	50/60 Hz

Power consumption**Transmitter**

Max. 10 W (active power)

switch-on current	Max. 36 A (<5 ms) as per NAMUR Recommendation NE 21
--------------------------	---





Current consumption**Transmitter**

- Max. 400 mA (24 V)
- Max. 200 mA (110 V, 50/60 Hz; 230 V, 50/60 Hz)

Power supply failure

- Totalizers stop at the last value measured.
- Depending on the device version, the configuration is retained in the device memory or in the pluggable data memory (HistoROM DAT).
- Error messages (incl. total operated hours) are stored.

Electrical connection**Connecting the transmitter**

-  Terminal assignment →  30
-  Device plugs available →  30

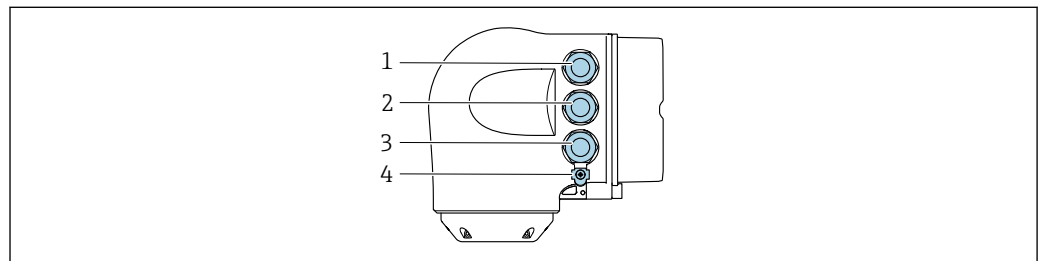

A0026781

- 1 Terminal connection for supply voltage
- 2 Terminal connection for signal transmission, input/output
- 3 Terminal connection for signal transmission, input/output or terminal for network connection via service interface (CDI-RJ45); Optional: terminal connection for external WLAN antenna or connection for remote display and operating module DKX001
- 4 Protective ground (PE)

-  An adapter for RJ45 and the M12 connector is optionally available:
Order code for "Accessories", option **NB**: "Adapter RJ45 M12 (service interface)"

The adapter connects the service interface (CDI-RJ45) to an M12 connector mounted in the cable entry. Therefore the connection to the service interface can be established via an M12 connector without opening the device.

-  Network connection via service interface (CDI-RJ45) →  92

Connecting in a ring topology

Device versions with EtherNet/IP and PROFINET communication protocols can be integrated into a ring topology. The device is integrated via the terminal connection for signal transmission (output 1) and the connection to the service interface (CDI-RJ45).

-  Integrate the transmitter into a ring topology:
 - EtherNet/IP
 - PROFINET

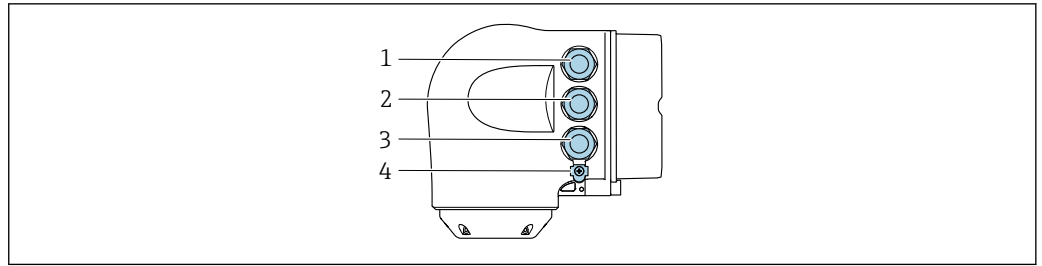

A0026781

- 1 Terminal connection for supply voltage
- 2 Terminal connection for signal transmission: PROFINET or EtherNet/IP (RJ45 connector)
- 3 Connection to service interface (CDI-RJ45)
- 4 Protective ground (PE)

i If the device has additional input/outputs, these are routed via the cable entry for the connection to the service interface (CDI-RJ45).

Connecting the remote display and operating module DKX001

- i** The remote display and operating module DKX001 is available as an optional extra → 103.
- The remote display and operating module DKX001 is only available for the following housing versions, order code for "Housing":
 - Option A "Aluminum, coated"
 - Option L "Cast, stainless"
 - The measuring device is always supplied with a dummy cover when the remote display and operating module DKX001 is ordered directly with the measuring device. Display or operation at the transmitter is not possible in this case.
 - If ordered subsequently, the remote display and operating module DKX001 may not be connected at the same time as the existing measuring device display module. Only one display or operation unit may be connected to the transmitter at any one time.

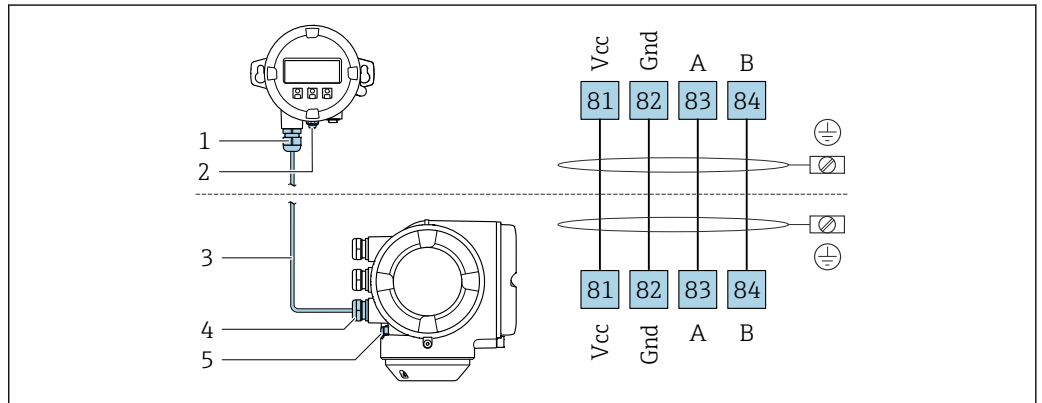

A0027518

- 1 Remote display and operating module DKX001
- 2 Protective earth (PE)
- 3 Connecting cable
- 4 Measuring device
- 5 Protective earth (PE)

Connection examples

Current output 4 to 20 mA HART

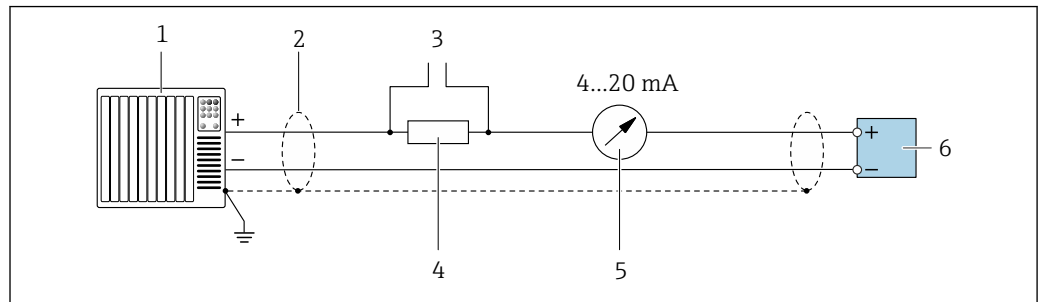

A0029055

2 Connection example for 4 to 20 mA HART current output (active)

- 1 Automation system with current input (e.g. PLC)
- 2 Cable shield provided at one end. The cable shield must be grounded at both ends to comply with EMC requirements; observe cable specifications → 43
- 3 Connection for HART operating devices → 86
- 4 Resistor for HART communication ($\geq 250 \Omega$); observe maximum load → 15
- 5 Analog display unit: observe maximum load → 15
- 6 Transmitter

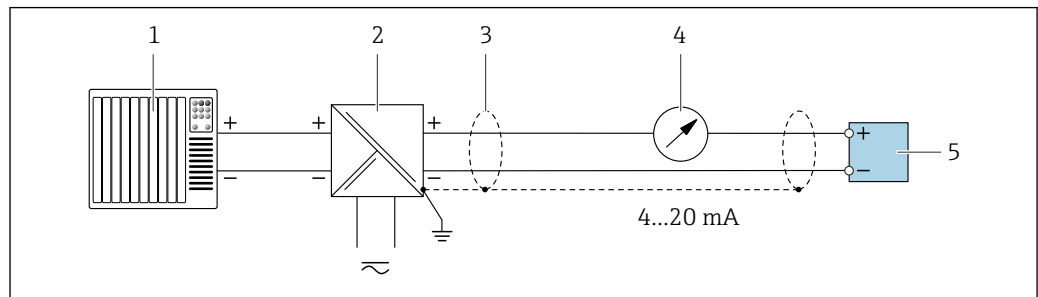

A0028762

3 Connection example for 4 to 20 mA HART current output (passive)

- 1 Automation system with current input (e.g. PLC)
- 2 Power supply
- 3 Cable shield provided at one end. The cable shield must be grounded at both ends to comply with EMC requirements; observe cable specifications → 43
- 4 Analog display unit: observe maximum load → 15
- 5 Transmitter

HART input

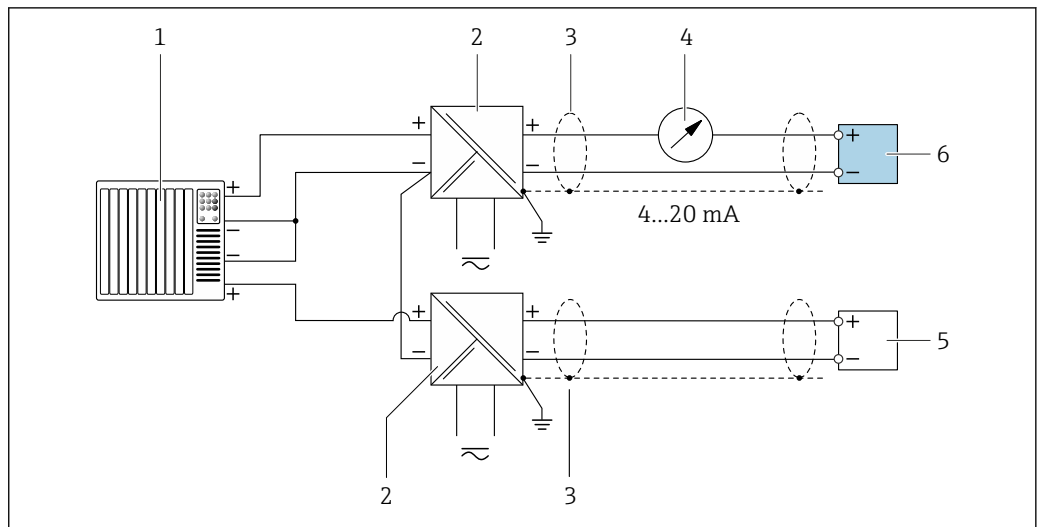

A0028763

4 Connection example for HART input with a common negative (passive)

- 1 Automation system with HART output (e.g. PLC)
- 2 Active barrier for power supply (e.g. RN221N)
- 3 Cable shield provided at one end. The cable shield must be grounded at both ends to comply with EMC requirements; observe cable specifications
- 4 Analog display unit: observe maximum load → 15
- 5 Pressure measuring device (e.g. Cerabar M, Cerabar S): see requirements
- 6 Transmitter

PROFIBUS PA

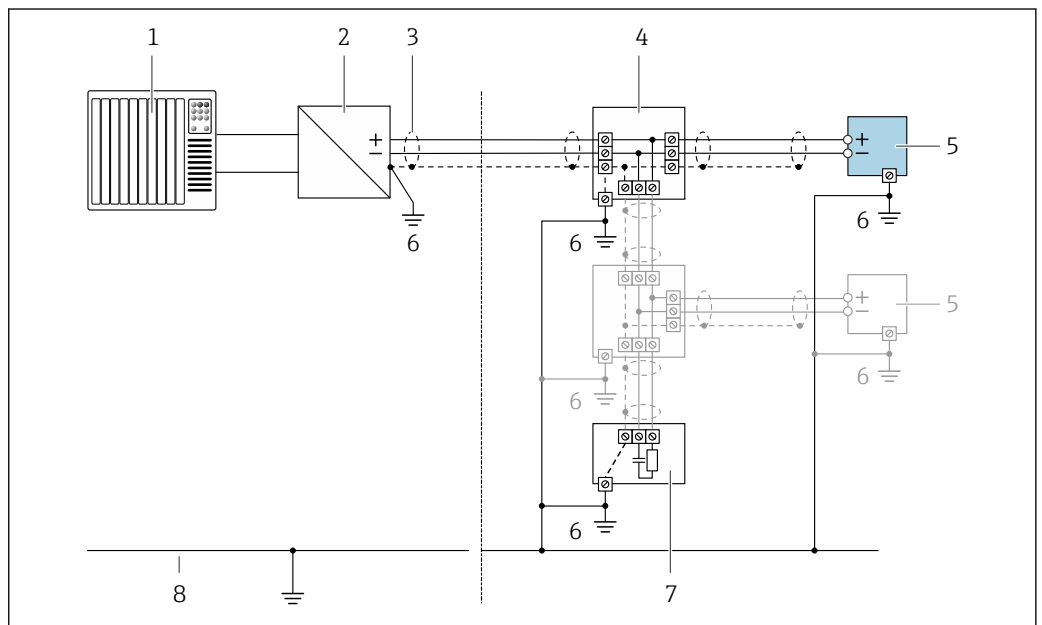

A0028768

5 Connection example for PROFIBUS PA

- 1 Control system (e.g. PLC)
- 2 PROFIBUS PA segment coupler
- 3 Cable shield provided at one end. The cable shield must be grounded at both ends to comply with EMC requirements; observe cable specifications
- 4 T-box
- 5 Measuring device
- 6 Local grounding
- 7 Bus terminator
- 8 Potential matching line

PROFIBUS DP

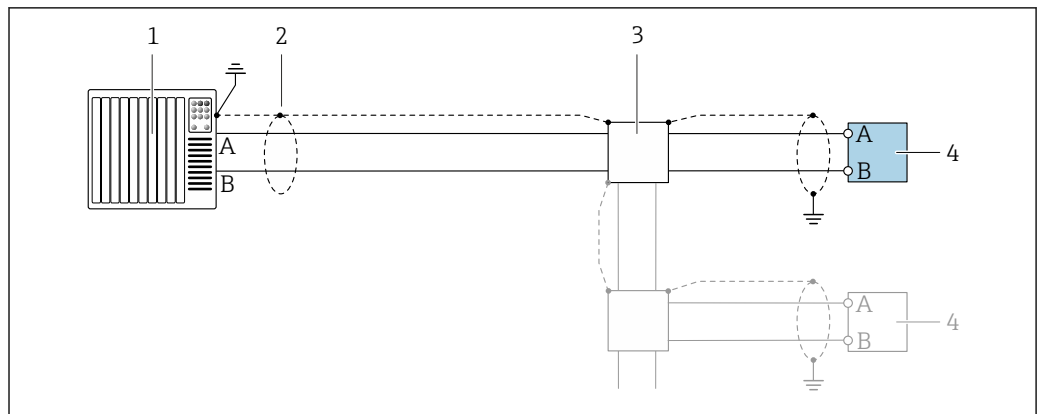

6 Connection example for PROFIBUS DP, non-hazardous area and Zone 2/Div. 2

- 1 Control system (e.g. PLC)
- 2 Cable shield provided at one end. The cable shield must be grounded at both ends to comply with EMC requirements; observe cable specifications
- 3 Distribution box
- 4 Transmitter

i If baud rates > 1.5 MBaud an EMC cable entry must be used and the cable shield must continue as far as the terminal wherever possible.

EtherNet/IP

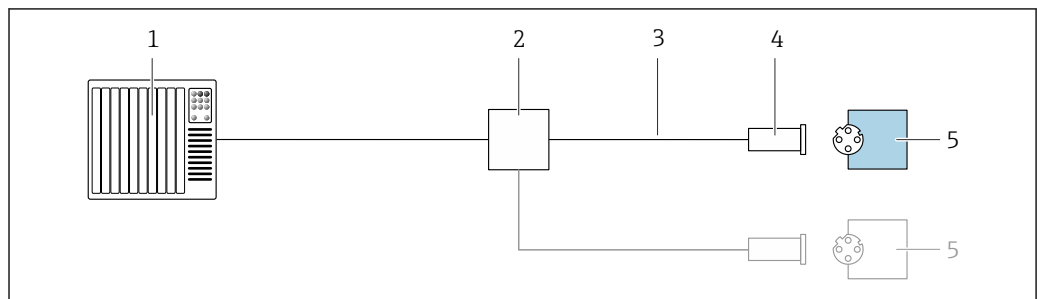

7 Connection example for EtherNet/IP

- 1 Control system (e.g. PLC)
- 2 Ethernet switch
- 3 Observe cable specifications
- 4 Device plug
- 5 Transmitter

EtherNet/IP: DLR (Device Level Ring)

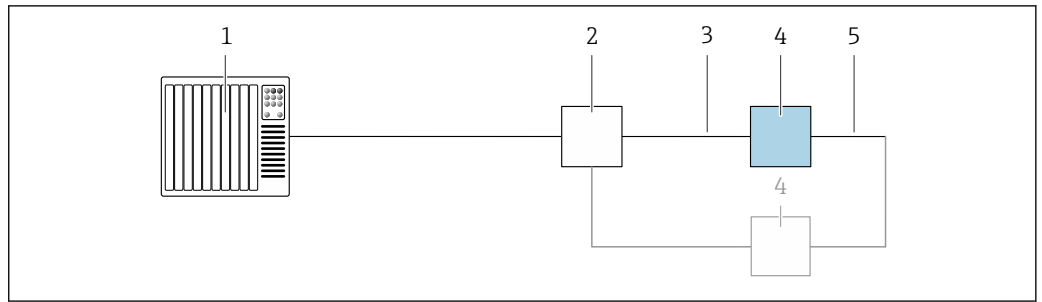

A0027544

- 1 Control system (e.g. PLC)
- 2 Ethernet switch
- 3 Observe cable specifications → 44
- 4 Transmitter
- 5 Connecting cable between the two transmitters

PROFINET

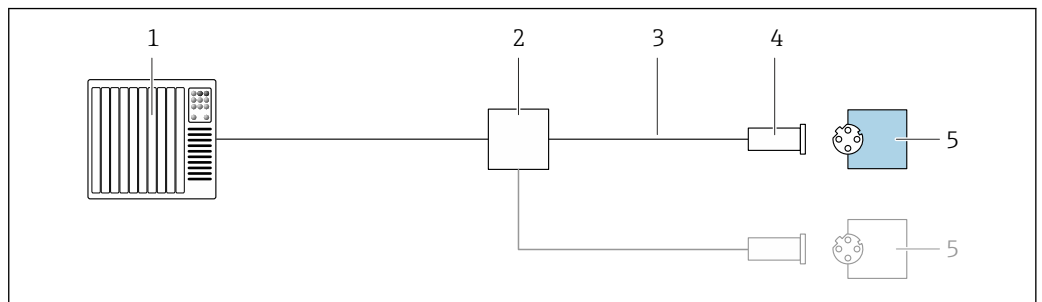

A0028767

8 Connection example for PROFINET

- 1 Control system (e.g. PLC)
- 2 Ethernet switch
- 3 Observe cable specifications
- 4 Device plug
- 5 Transmitter

PROFINET: MRP (Media Redundancy Protocol)

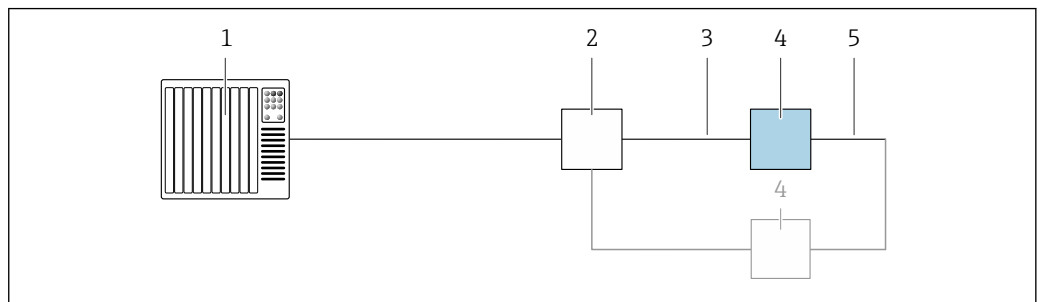

A0027544

- 1 Control system (e.g. PLC)
- 2 Ethernet switch
- 3 Observe cable specifications → 44
- 4 Transmitter
- 5 Connecting cable between the two transmitters

PROFINET: system redundancy S2

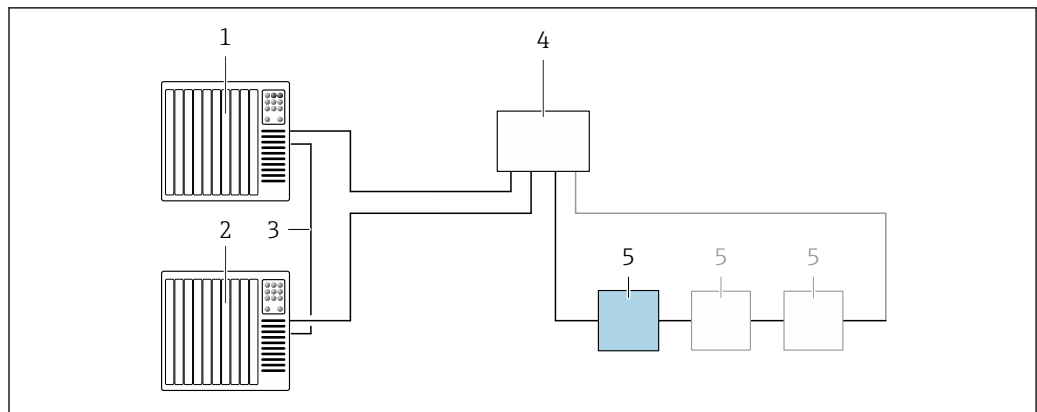

A0039553

9 Connection example for system redundancy S2

- 1 Control system 1 (e.g. PLC)
- 2 Synchronization of control systems
- 3 Control system 2 (e.g. PLC)
- 4 Industrial Ethernet Managed Switch
- 5 Transmitter

FOUNDATION Fieldbus

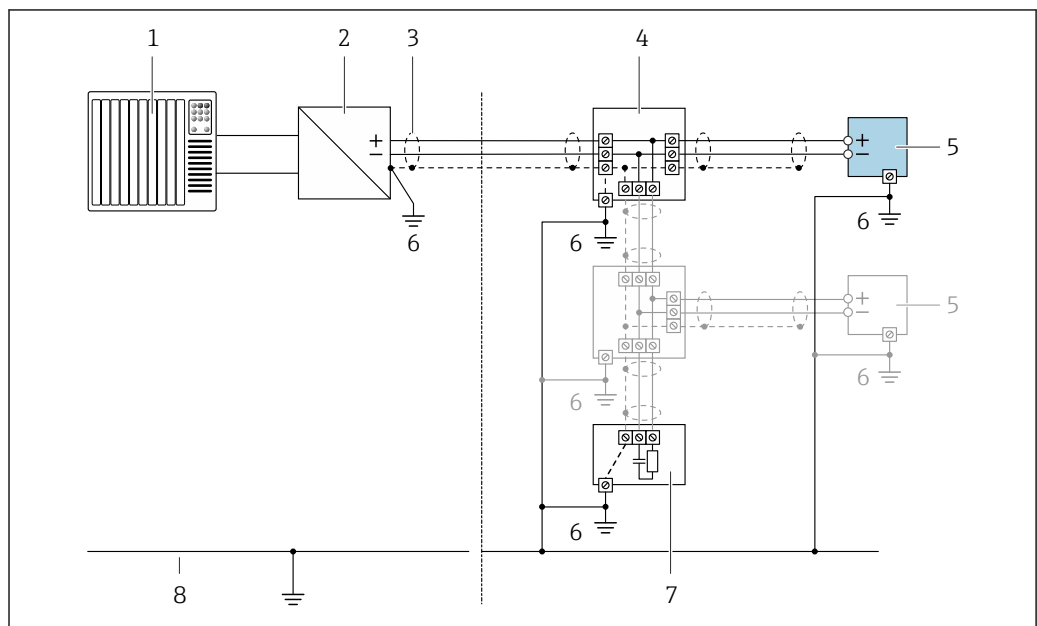

A0028768

10 Connection example for FOUNDATION Fieldbus

- 1 Control system (e.g. PLC)
- 2 Power Conditioner (FOUNDATION Fieldbus)
- 3 Cable shield provided at one end. The cable shield must be grounded at both ends to comply with EMC requirements; observe cable specifications
- 4 T-box
- 5 Measuring device
- 6 Local grounding
- 7 Bus terminator
- 8 Potential matching line

Modbus RS485

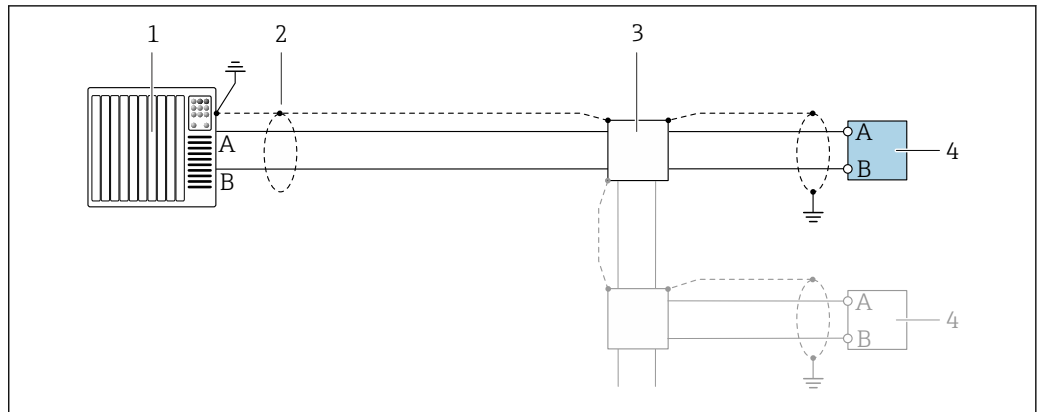

A0028765

11 Connection example for Modbus RS485, non-hazardous area and Zone 2; Class I, Division 2

- 1 Control system (e.g. PLC)
- 2 Cable shield provided at one end. The cable shield must be grounded at both ends to comply with EMC requirements; observe cable specifications
- 3 Distribution box
- 4 Transmitter

Current output 4-20 mA

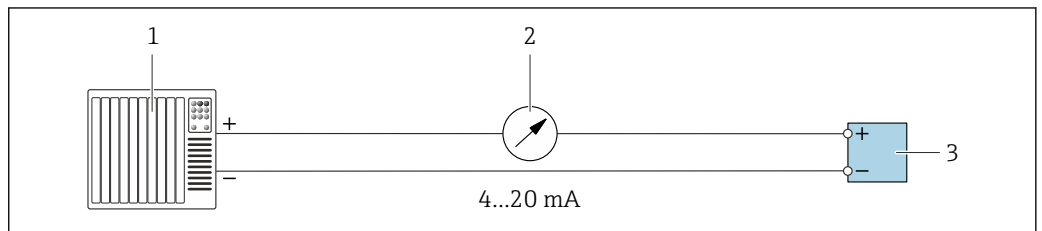

A0028758

12 Connection example for 4-20 mA current output (active)

- 1 Automation system with current input (e.g. PLC)
- 2 Analog display unit: observe maximum load → 15
- 3 Transmitter

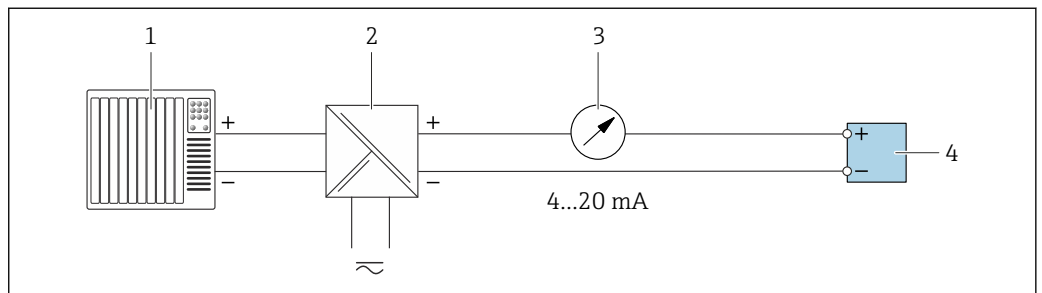

A0028759

13 Connection example for 4-20 mA current output (passive)

- 1 Automation system with current input (e.g. PLC)
- 2 Active barrier for power supply (e.g. RN221N)
- 3 Analog display unit: observe maximum load → 15
- 4 Transmitter

Pulse/frequency output

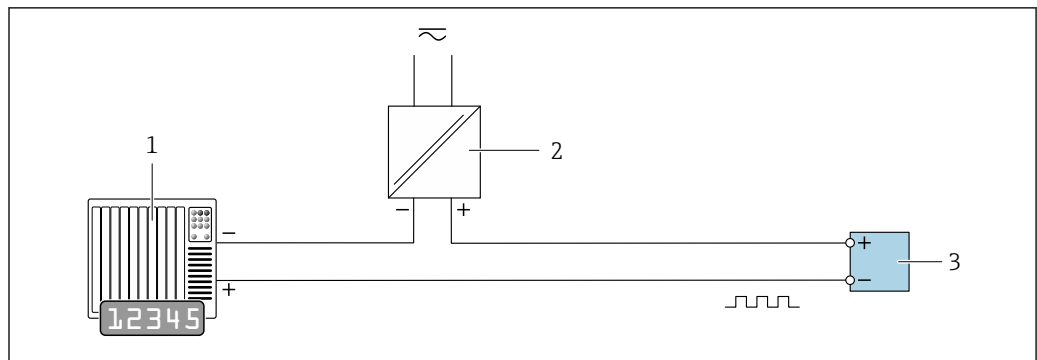

A0028761

14 Connection example for pulse/frequency output (passive)

- 1 Automation system with pulse/frequency input (e.g. PLC)
- 2 Power supply
- 3 Transmitter: Observe input values → 18

Switch output

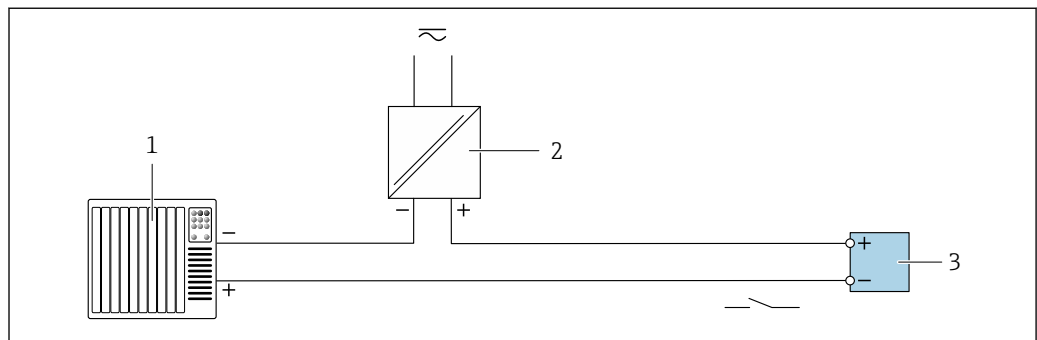

A0028760

15 Connection example for switch output (passive)

- 1 Automation system with switch input (e.g. PLC)
- 2 Power supply
- 3 Transmitter: Observe input values → 18

Double pulse output

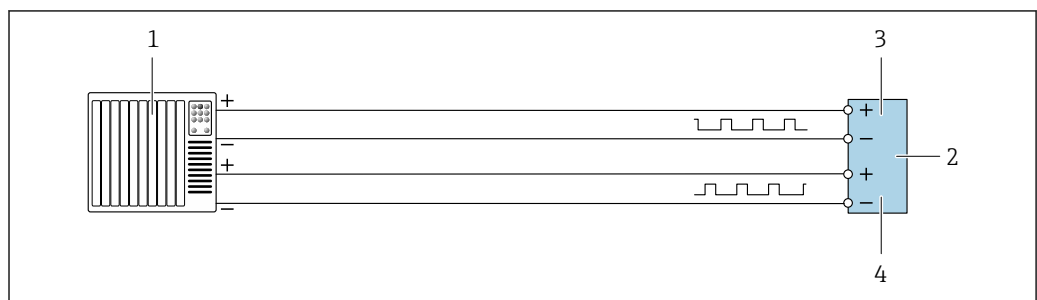

A0029280

16 Connection example for double pulse output (active)

- 1 Automation system with double pulse input (e.g. PLC)
- 2 Transmitter: Observe input values → 19
- 3 Double pulse output
- 4 Double pulse output (slave), phase-shifted

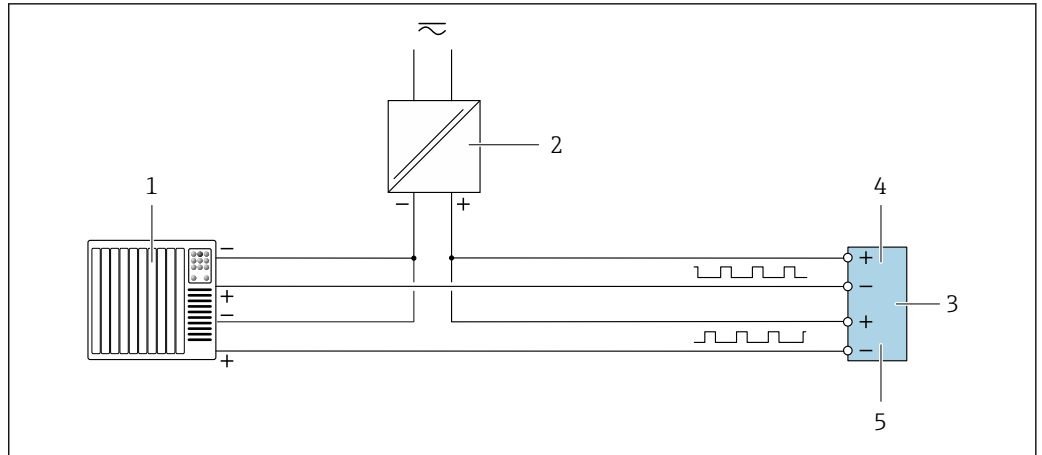

A0029279

17 Connection example for double pulse output (passive)

- 1 Automation system with double pulse input (e.g. PLC)
- 2 Power supply
- 3 Transmitter: Observe input values → 19
- 4 Double pulse output
- 5 Double pulse output (slave), phase-shifted

Relay output

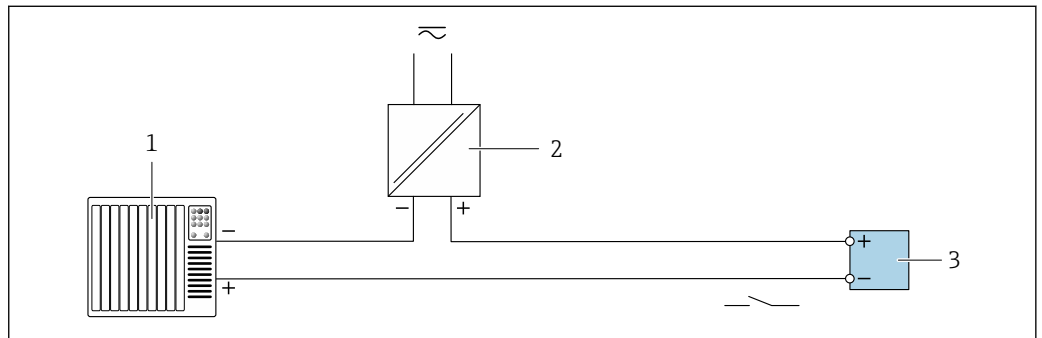

A0028760

18 Connection example for relay output (passive)

- 1 Automation system with relay input (e.g. PLC)
- 2 Power supply
- 3 Transmitter: Observe input values → 20

Current input

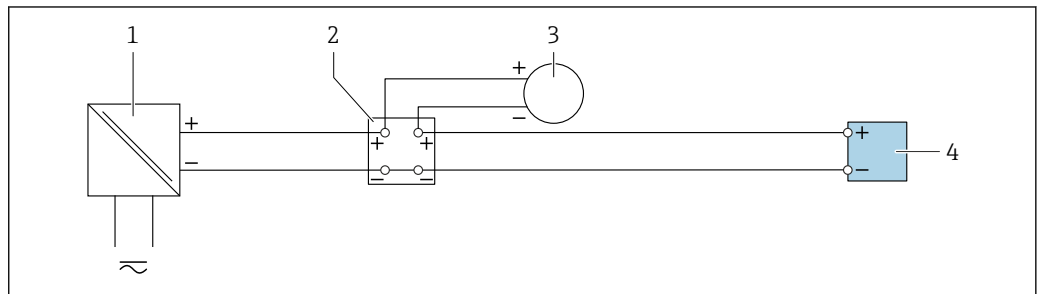

A0028915

19 Connection example for 4 to 20 mA current input

- 1 Power supply
- 2 Terminal box
- 3 External measuring device (to read in pressure or temperature, for instance)
- 4 Transmitter

Status input

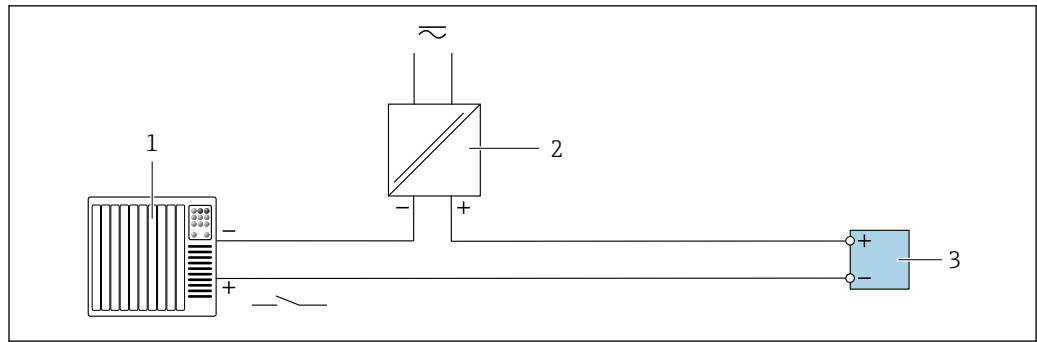

A0028764

20 Connection example for status input

- 1 Automation system with status output (e.g. PLC)
- 2 Power supply
- 3 Transmitter

Potential equalization

Requirements

No special measures for potential equalization are required.
 Please consider the following to ensure correct measurement:

- Same electrical potential for the fluid and sensor
- Company-internal grounding concepts

Terminals

Spring-loaded terminals: Suitable for strands and strands with ferrules.
 Conductor cross-section 0.2 to 2.5 mm² (24 to 12 AWG).

Cable entries

- Cable gland: M20 × 1.5 with cable \varnothing 6 to 12 mm (0.24 to 0.47 in)
- Thread for cable entry:
 - NPT 1/2"
 - G 1/2"
 - M20
- Device plug for digital communication: M12
 Only available for certain device versions → 30.

Pin assignment, device plug

FOUNDATION Fieldbus

Pin	Assignment		Coding	Plug/socket
	+	-		
1	+	Signal +	A	Plug
2	-	Signal -		
3		Grounding		
4		Not assigned		

PROFIBUS PA

Pin	Assignment		Coding	Plug/socket
	+	-		
1	+	PROFIBUS PA +	A	Plug
2		Grounding		
3	-	PROFIBUS PA -		
4		Not assigned		

PROFINET

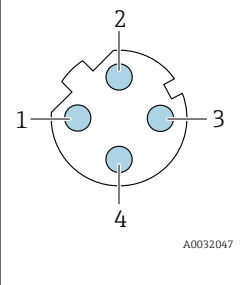
	Pin		Assignment
	1	+	TD +
	2	+	RD +
	3	-	TD -
	4	-	RD -
Coding		Plug/socket	
D		Socket	

-  Recommended plug:
- Binder, series 763, part no. 99 3729 810 04
 - Phoenix, part no. 1543223 SACC-M12MSD-4Q

EtherNet/IP

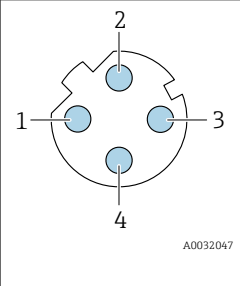
	Pin		Assignment
	1	+	Tx
	2	+	Rx
	3	-	Tx
	4	-	Rx
Coding		Plug/socket	
D		Socket	

-  Recommended plug:
- Binder, series 763, part no. 99 3729 810 04
 - Phoenix, part no. 1543223 SACC-M12MSD-4Q

Service interface

Order code for "Accessories mounted", option **NB**: Adapter RJ45 M12 (service interface)

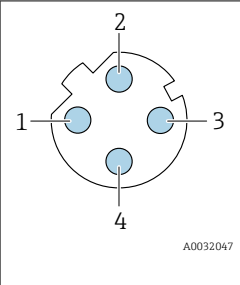
	Pin		Assignment
	1	+	Tx
	2	+	Rx
	3	-	Tx
	4	-	Rx
Coding		Plug/socket	
D		Socket	

-  Recommended plug:
- Binder, series 763, part no. 99 3729 810 04
 - Phoenix, part no. 1543223 SACC-M12MSD-4Q

Cable specification

Permitted temperature range

- The installation guidelines that apply in the country of installation must be observed.
- The cables must be suitable for the minimum and maximum temperatures to be expected.

Power supply cable (incl. conductor for the inner ground terminal)

Standard installation cable is sufficient.

Signal cable

Current output 4 to 20 mA HART

A shielded cable is recommended. Observe grounding concept of the plant.

PROFIBUS PA

Twisted, shielded two-wire cable. Cable type A is recommended .



For further information on planning and installing PROFIBUS networks see:

- Operating Instructions "PROFIBUS DP/PA: Guidelines for planning and commissioning" (BA00034S)
- PNO Directive 2.092 "PROFIBUS PA User and Installation Guideline"
- IEC 61158-2 (MBP)

PROFIBUS DP

The IEC 61158 standard specifies two types of cable (A and B) for the bus line which can be used for every transmission rate. Cable type A is recommended.

Cable type	A
Characteristic impedance	135 to 165 Ω at a measuring frequency of 3 to 20 MHz
Cable capacitance	< 30 pF/m
Wire cross-section	> 0.34 mm ² (22 AWG)
Cable type	Twisted pairs
Loop resistance	\leq 110 Ω /km
Signal damping	Max. 9 dB over the entire length of the cable cross-section
Shield	Copper braided shielding or braided shielding with foil shield. When grounding the cable shield, observe the grounding concept of the plant.



For further information on planning and installing PROFIBUS networks see:

- Operating Instructions "PROFIBUS DP/PA: Guidelines for planning and commissioning" (BA00034S)
- PNO Directive 2.092 "PROFIBUS PA User and Installation Guideline"
- IEC 61158-2 (MBP)

EtherNet/IP

The standard ANSI/TIA/EIA-568-B.2 Annex specifies CAT 5 as the minimum category for a cable used for EtherNet/IP. CAT 5e and CAT 6 are recommended.



For more information on planning and installing EtherNet/IP networks, please refer to the "Media Planning and Installation Manual. EtherNet/IP" of ODVA Organization

PROFINET

Standard IEC 61156-6 specifies CAT 5 as the minimum category for a cable used for PROFINET. CAT 5e and CAT 6 are recommended.



For more information on planning and installing PROFINET networks, see: "PROFINET Cabling and Interconnection Technology", Guideline for PROFINET

FOUNDATION Fieldbus

Twisted, shielded two-wire cable.



For further information on planning and installing FOUNDATION Fieldbus networks see:

- Operating Instructions for "FOUNDATION Fieldbus Overview" (BA00013S)
- FOUNDATION Fieldbus Guideline
- IEC 61158-2 (MBP)

Modbus RS485

The EIA/TIA-485 standard specifies two types of cable (A and B) for the bus line which can be used for every transmission rate. Cable type A is recommended.

Cable type	A
Characteristic impedance	135 to 165 Ω at a measuring frequency of 3 to 20 MHz
Cable capacitance	< 30 pF/m
Wire cross-section	> 0.34 mm ² (22 AWG)
Cable type	Twisted pairs
Loop resistance	≤110 Ω/km
Signal damping	Max. 9 dB over the entire length of the cable cross-section
Shield	Copper braided shielding or braided shielding with foil shield. When grounding the cable shield, observe the grounding concept of the plant.

Current output 0/4 to 20 mA

Standard installation cable is sufficient.

Pulse/frequency/switch output

Standard installation cable is sufficient.

Double pulse output

Standard installation cable is sufficient.

Relay output

Standard installation cable is sufficient.

Current input 0/4 to 20 mA

Standard installation cable is sufficient.

Status input

Standard installation cable is sufficient.

Connecting cable for transmitter - remote display and operating module DKX001

Standard cable

A standard cable can be used as the connecting cable.

Standard cable	4 cores (2 pairs); pair-stranded with common shield
Shielding	Tin-plated copper-braid, optical cover ≥ 85 %
Capacitance: core/shield	Maximum 1 000 nF for Zone 1; Class I, Division 1
L/R	Maximum 24 μH/Ω for Zone 1; Class I, Division 1
Cable length	Maximum 300 m (1 000 ft), see the following table

Cross-section	Cable length for use in: <ul style="list-style-type: none"> ■ Non-hazardous area ■ Hazardous area: Zone 2; Class I, Division 2 ■ Hazardous area: Zone 1; Class I, Division 1
0.34 mm ² (22 AWG)	80 m (270 ft)
0.50 mm ² (20 AWG)	120 m (400 ft)
0.75 mm ² (18 AWG)	180 m (600 ft)

Cross-section	Cable length for use in: <ul style="list-style-type: none"> ▪ Non-hazardous area ▪ Hazardous area: Zone 2; Class I, Division 2 ▪ Hazardous area: Zone 1; Class I, Division 1
1.00 mm ² (17 AWG)	240 m (800 ft)
1.50 mm ² (15 AWG)	300 m (1000 ft)

Optionally available connecting cable



Standard cable	2 × 2 × 0.34 mm ² (22 AWG) PVC cable ¹⁾ with common shield (2 pairs, pair-stranded)
Flame resistance	According to DIN EN 60332-1-2
Oil-resistance	According to DIN EN 60811-2-1
Shielding	Tin-plated copper-braid, optical cover ≥ 85 %
Capacitance: core/shield	≤200 pF/m
L/R	≤24 μH/Ω
Available cable length	10 m (35 ft)
Operating temperature	When mounted in a fixed position: -50 to +105 °C (-58 to +221 °F); when cable can move freely: -25 to +105 °C (-13 to +221 °F)

1) UV radiation can impair the cable outer sheath. Protect the cable from direct sunshine where possible.

Performance characteristics

Reference operating conditions

- Error limits based on ISO 11631
- Water with +15 to +45 °C (+59 to +113 °F) at 2 to 6 bar (29 to 87 psi)
- Specifications as per calibration protocol
- Accuracy based on accredited calibration rigs that are traced to ISO 17025.

 To obtain measured errors, use the *Applicator* sizing tool →  105

Maximum measured error

o.r. = of reading; 1 g/cm³ = 1 kg/l; T = medium temperature

Base accuracy

 Design fundamentals →  49

Mass flow and volume flow (liquids)

±0.05 % o.r. (PremiumCal; order code for "Calibration flow", option D, for mass flow)
±0.10 % o.r.

Mass flow (gases)

±0.35 % o.r.

Density

±0.2 kg/m³ / ±0.0002 g/cm³

Valid between 20 °C and 60 °C. The measured error increases by 0.015 kg/(m³·°C) outside the temperature range

Valid range for density calibration: 0 to 2 000 kg/m³, +20 to +60 °C (+68 to +140 °F)

For highly accurate density measurement, avoid significant tensile stresses due to the installation and ensure the flow velocity in the nominal diameter is > 0.1 m/s.

Temperature

$$\pm 0.1 \text{ }^\circ\text{C} \pm 0.003 \cdot T \text{ }^\circ\text{C} (\pm 0.18 \text{ }^\circ\text{F} \pm 0.003 \cdot (T - 32) \text{ }^\circ\text{F})$$

Zero point stability

DN		Zero point stability	
[mm]	[in]	[kg/h]	[lb/min]
25	1	0.36	0.013
50	2	1.8	0.066
80	3	5.4	0.20
100	4	11.5	0.42

Flow values

Flow values as turndown parameter depending on nominal diameter.

SI units

DN [mm]	1:1	1:10	1:20	1:50	1:100	1:500
	[kg/h]	[kg/h]	[kg/h]	[kg/h]	[kg/h]	[kg/h]
25	20 000	2 000	1 000	400	200	40
50	80 000	8 000	4 000	1 600	800	160
80	200 000	20 000	10 000	4 000	2 000	400
100	550 000	55 000	27 500	11 000	5 500	1 100

US units

DN [inch]	1:1	1:10	1:20	1:50	1:100	1:500
	[lb/min]	[lb/min]	[lb/min]	[lb/min]	[lb/min]	[lb/min]
1	736	73.6	36.8	14.7	7.4	1.5
2	2 944	294.4	147.2	58.9	29.5	5.9
3	7 360	736	368	147.2	73.6	14.7
4	20 240	2 024	1 012	404.8	202.4	40.5

Accuracy of outputs

The outputs have the following base accuracy specifications.

Current output

Accuracy	$\pm 5 \mu\text{A}$
-----------------	---------------------

Pulse/frequency output



o.r. = of reading

Accuracy	Max. ± 50 ppm o.r. (over the entire ambient temperature range)
-----------------	--

Repeatability

o.r. = of reading; $1 \text{ g/cm}^3 = 1 \text{ kg/l}$; T = medium temperature

Base repeatability

 Design fundamentals →  49

Mass flow and volume flow (liquids)

±0.025 % o.r.

Mass flow (gases)

±0.25 % o.r.

Density (liquids)

±0.1 kg/m³ / ±0.0001 g/cm³

Temperature

±0.05 °C ± 0.0025 · T °C (±0.09 °F ± 0.0015 · (T-32) °F)

Response time

The response time depends on the configuration (damping).

Influence of ambient temperature

Current output

Temperature coefficient	Max. 1 µA/°C
--------------------------------	--------------

Pulse/frequency output

Temperature coefficient	No additional effect. Included in accuracy.
--------------------------------	---

Influence of medium temperature

Mass flow and volume flow

o.f.s. = of full scale value

When there is a difference between the temperature for zero point adjustment and the process temperature, the additional measured error of the sensor is typically

DN 25 (1"): ±0.0001 % o.f.s./°C (±0.00005 % o.f.s./°F)

DN 50, 80, 100 (2", 3", 4"): ±0.00015 % o.f.s./°C (±0.000075 % o.f.s./°F)

The effect is reduced if zero point adjustment is performed at process temperature.

Density

When there is a difference between the density calibration temperature and the process temperature, the typical measured error of the sensor is ±0.015 kg/m³ /°C (±0.0075 kg/m³ /°F)

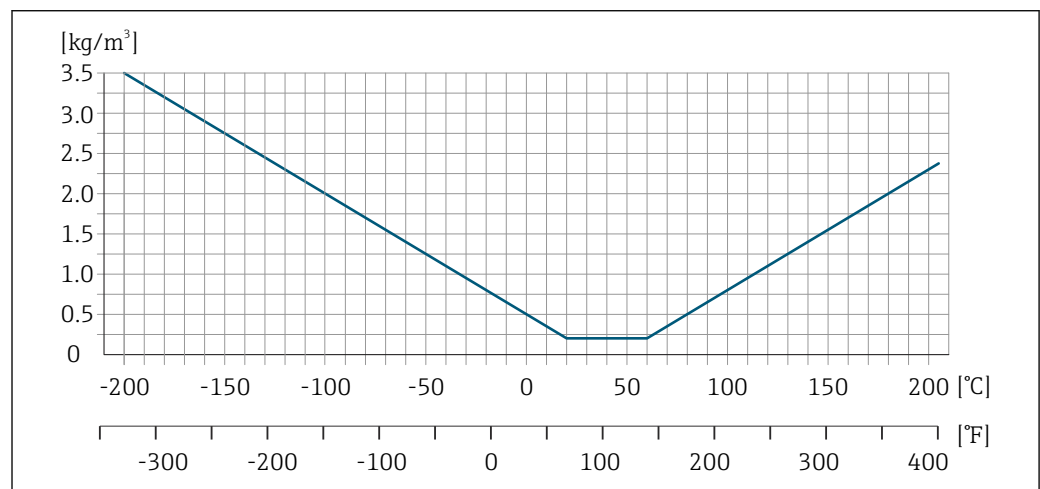

A0028731

Temperature

±0.005 · T °C (± 0.005 · (T - 32) °F)

Influence of medium pressure

Mass flow

DN		[% o.r./bar] ±0.0005	[% o.r./psi] ±0.00003
[mm]	[in]		
25	1	-0.0040	-0.00027
50	2	-0.0025	-0.00017
80	3	-0.0085	-0.00057
100	4	-0.0040	-0.00027

Volume flow

DN		[% o.r./bar] ±0.0008	[% o.r./psi] ±0.00005
[mm]	[in]		
25	1	-0.0011	-0.000073
50	2	+0.0009	+0.000060
80	3	-0.0061	-0.004070
100	4	-0.0034	-0.000227

Density

DN		[% o.r./bar] ±0.0006	[% o.r./psi] ±0.00004
[mm]	[in]		
25	1	-0.0029	-0.000193
50	2	-0.0034	-0.000227
80	3	-0.0024	-0.000160
100	4	-0.0006	-0.000040

Design fundamentals

o.r. = of reading, o.f.s. = of full scale value

BaseAccu = base accuracy in % o.r., BaseRepeat = base repeatability in % o.r.

MeasValue = measured value; ZeroPoint = zero point stability

Calculation of the maximum measured error as a function of the flow rate

Flow rate	Maximum measured error in % o.r.
$\geq \frac{\text{ZeroPoint}}{\text{BaseAccu}} \cdot 100$ <small>A0021332</small>	$\pm \text{BaseAccu}$ <small>A0021339</small>
$< \frac{\text{ZeroPoint}}{\text{BaseAccu}} \cdot 100$ <small>A0021333</small>	$\pm \frac{\text{ZeroPoint}}{\text{MeasValue}} \cdot 100$ <small>A0021334</small>

Calculation of the maximum repeatability as a function of the flow rate

Flow rate	Maximum repeatability in % o.r.
$\geq \frac{1/2 \cdot \text{ZeroPoint}}{\text{BaseRepeat}} \cdot 100$ <small>A0021335</small>	$\pm \text{BaseRepeat}$ <small>A0021340</small>
$< \frac{1/2 \cdot \text{ZeroPoint}}{\text{BaseRepeat}} \cdot 100$ <small>A0021336</small>	$\pm 1/2 \cdot \frac{\text{ZeroPoint}}{\text{MeasValue}} \cdot 100$ <small>A0021337</small>

Example for maximum measured error

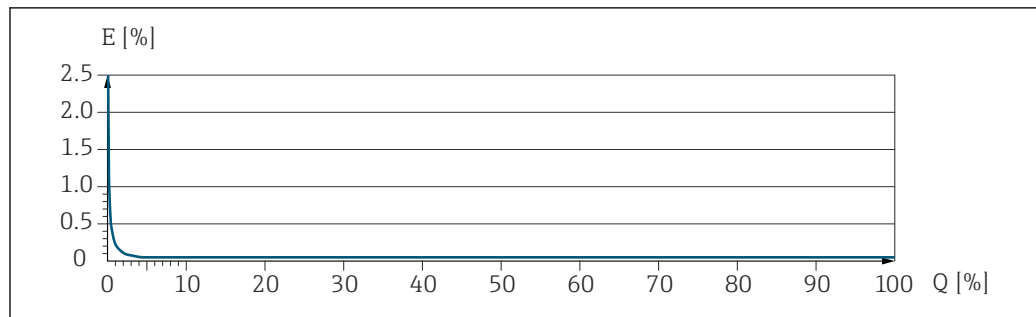

A0028741

E Maximum measured error in % o.r. (example with PremiumCal)

Q Flow rate in % of maximum full scale value

Installation

Mounting location

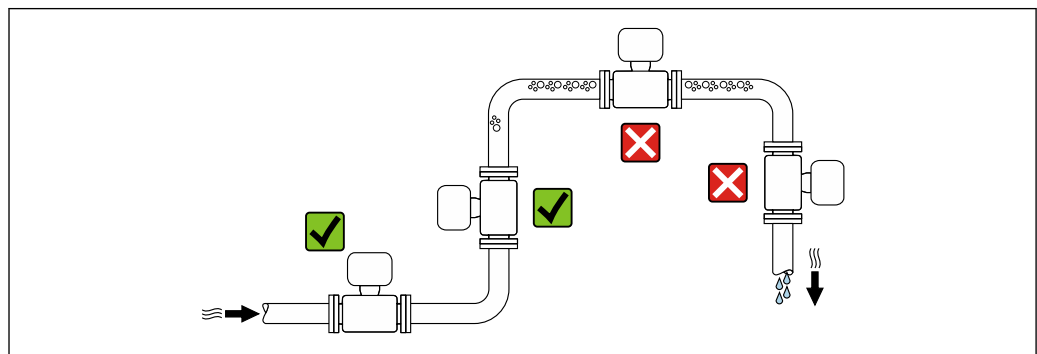

A0028772

To prevent measuring errors arising from accumulation of gas bubbles in the measuring tube, avoid the following mounting locations in the pipe:

- Highest point of a pipeline.
- Directly upstream of a free pipe outlet in a down pipe.

Installation in down pipes

However, the following installation suggestion allows for installation in an open vertical pipeline. Pipe restrictions or the use of an orifice with a smaller cross-section than the nominal diameter prevent the sensor running empty while measurement is in progress.

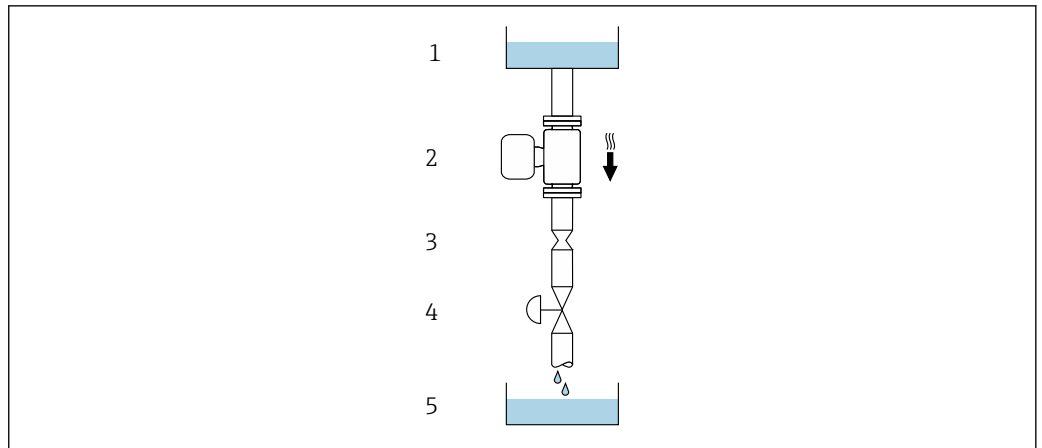

A0028773

☑ 21 Installation in a down pipe (e.g. for batching applications)

- 1 Supply tank
- 2 Sensor
- 3 Orifice plate, pipe restriction
- 4 Valve
- 5 Batching tank

DN		Ø orifice plate, pipe restriction	
[mm]	[in]	[mm]	[in]
25	1	14	0.55
50	2	28	1.10
80	3	50	1.97
100	4	65	2.60

Orientation

The direction of the arrow on the sensor nameplate helps you to install the sensor according to the flow direction (direction of medium flow through the piping).

Orientation		Recommendation
A	Vertical orientation	 A0015591 ☑☑ ¹⁾
B	Horizontal orientation, transmitter at top	 A0015589 ☑☑ ²⁾ Exceptions: → ☑ 22, ☑ 52
C	Horizontal orientation, transmitter at bottom	 A0015590 ☑☑ ³⁾ Exceptions: → ☑ 22, ☑ 52
D	Horizontal orientation, transmitter at side	 A0015592 ☑☑ → ☑ 52 ⁴⁾

- 1) This orientation is recommended to ensure self-draining.
- 2) Applications with low process temperatures may decrease the ambient temperature. To maintain the minimum ambient temperature for the transmitter, this orientation is recommended.
- 3) Applications with high process temperatures may increase the ambient temperature. To maintain the maximum ambient temperature for the transmitter, this orientation is recommended.
- 4) Not recommended for inhomogeneous media.

If a sensor is installed horizontally with a curved measuring tube, match the position of the sensor to the fluid properties.

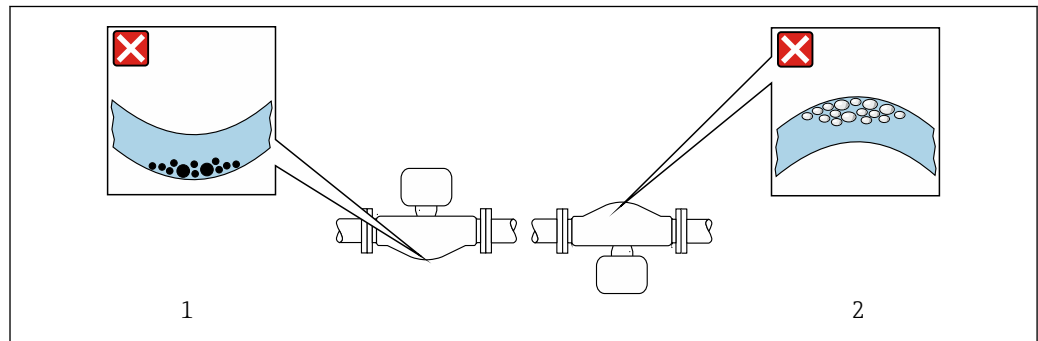

22 Orientation of sensor with curved measuring tube

- 1 Avoid this orientation for fluids with entrained solids: Risk of solids accumulating.
- 2 Avoid this orientation for outgassing fluids: Risk of gas accumulating.

Inlet and outlet runs

No special precautions need to be taken for fittings which create turbulence, such as valves, elbows or T-pieces, as long as no cavitation occurs → 60.

Special mounting instructions

Drainability

The measuring tubes can be completely drained and protected against solids build-up in vertical orientation.

Sanitary compatibility

- i** When installing in hygienic applications, please refer to the information in the "Certificates and approvals/hygienic compatibility" section → 98
- In the case of measuring devices with the order code for "Housing", option B "Stainless, hygienic", to seal the connection compartment cover, screw it closed finger-tight and then tighten it by another 45° (corresponds to 15 Nm).

Rupture disk

Information that is relevant to the process: → 60.

WARNING

Danger from medium escaping!

Medium escaping under pressure can cause injury or material damage.

- ▶ Take precautions to prevent danger to persons and damage if the rupture disk is actuated.
- ▶ Observe information on the rupture disk sticker.
- ▶ Make sure that the function and operation of the rupture disk is not impeded through the installation of the device.
- ▶ Do not use a heating jacket.
- ▶ Do not remove or damage the rupture disk.

The position of the rupture disk is indicated on a sticker beside it.

The transportation guard must be removed.

The existing connecting nozzles are not intended for the purpose of rinsing or pressure monitoring, but instead serve as the mounting location for the rupture disk.

In the event of a failure of the rupture disk, a drain device can be screwed onto the female thread of the rupture disk in order to drain off any escaping medium.

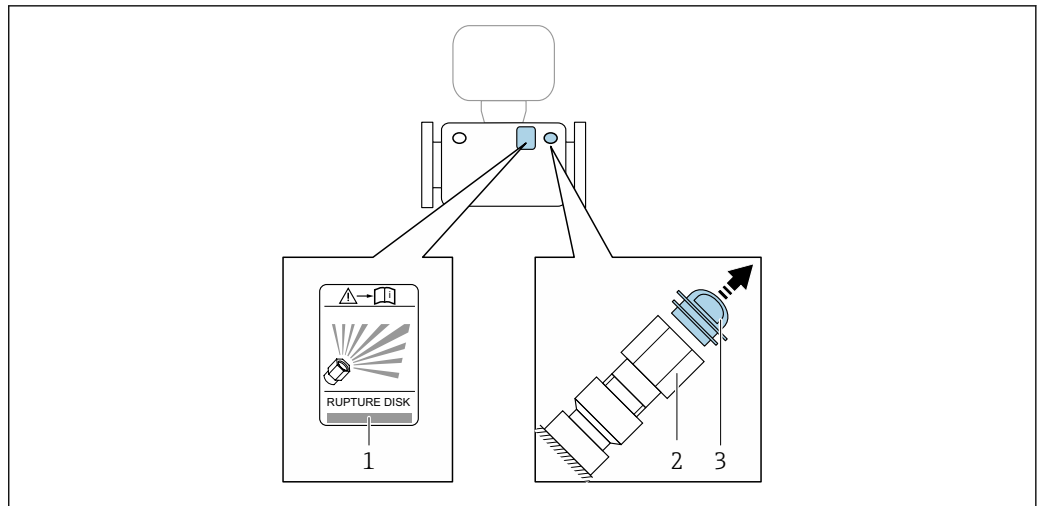

A0030346

- 1 Rupture disk label
- 2 Rupture disk with 1/2" NPT female thread and 1" width across flat
- 3 Transportation guard

For information on the dimensions: see the "Mechanical construction" section (accessories)

Zero point adjustment

All measuring devices are calibrated in accordance with state-of-the-art technology. Calibration takes place under reference conditions → 46. Therefore, a zero point adjustment in the field is generally not required.

Experience shows that zero point adjustment is advisable only in special cases:

- To achieve maximum measuring accuracy even with low flow rates.
- Under extreme process or operating conditions (e.g. very high process temperatures or very high-viscosity fluids).

Protective cover

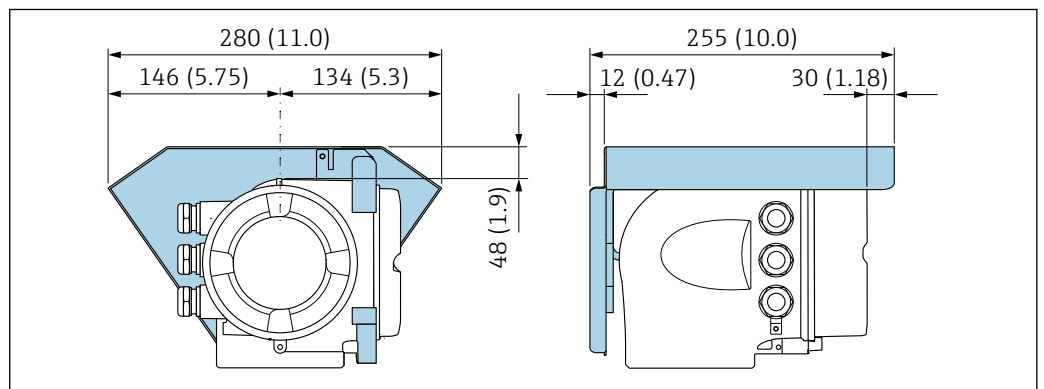

A0029553

23 Engineering unit mm (in)

Determining the pitch angle and roll angle

i For correct measurement, the pitch angle and roll angle must be determined and entered with a tolerance of $\pm 10^\circ$.

Pitch angle	Roll angle
The possible pitch angle that can be configured is the blue area of angle α .	The possible roll angle that can be configured is the blue area of angle β .

Environment

Ambient temperature range	Measuring device	<ul style="list-style-type: none"> ■ -40 to +60 °C (-40 to +140 °F) ■ Order code for "Test, certificate", option JP: -50 to +60 °C (-58 to +140 °F)
	Readability of the local display	-20 to +60 °C (-4 to +140 °F) The readability of the display may be impaired at temperatures outside the temperature range.

i Dependency of ambient temperature on medium temperature → 55

- ▶ If operating outdoors:
Avoid direct sunlight, particularly in warm climatic regions.

i You can order a weather protection cover from Endress+Hauser. → 103.

Storage temperature	-50 to +80 °C (-58 to +176 °F)
---------------------	--------------------------------

Climate class	DIN EN 60068-2-38 (test Z/AD)
---------------	-------------------------------

Degree of protection	Measuring device <ul style="list-style-type: none"> ■ As standard: IP66/67, type 4X enclosure ■ When housing is open: IP20, type 1 enclosure ■ Display module: IP20, type 1 enclosure ■ With the order code for "Sensor options", option CM: IP69 can also be ordered
	External WLAN antenna IP67

Vibration- and shock-resistance	Vibration sinusoidal, in accordance with IEC 60068-2-6 <ul style="list-style-type: none"> ■ 2 to 8.4 Hz, 3.5 mm peak ■ 8.4 to 2 000 Hz, 1 g peak
	Vibration broad-band random, according to IEC 60068-2-64

- 10 to 200 Hz, 0.003 g²/Hz
- 200 to 2 000 Hz, 0.001 g²/Hz
- Total: 1.54 g rms

Shock half-sine, according to IEC 60068-2-27

6 ms 30 g

Rough handling shocks, according to IEC 60068-2-31

Interior cleaning

- Cleaning in place (CIP)
- Sterilization in place (SIP)

Options

- Oil- and grease-free version for wetted parts, without declaration
Order code for "Service", option HA
- Oil- and grease-free version for wetted parts as per IEC/TR 60877-2.0 and BOC 50000810-4, with declaration
Order code for "Service", option HB

Electromagnetic compatibility (EMC)

- As per IEC/EN 61326 and NAMUR Recommendation 21 (NE 21)
- Device version with PROFIBUS DP: Complies with emission limits for industry as per EN 50170 Volume 2, IEC 61784

 The following applies for PROFIBUS DP: If baud rates > 1.5 Mbaud, an EMC cable entry must be used and the cable shield must continue as far as the terminal wherever possible.

 Details are provided in the Declaration of Conformity.

Process

Medium temperature range

Standard version	-50 to +205 °C (-58 to +401 °F)	Order code for "Measuring tube mat., wetted surface", option SA, SB
Low-temperature version	-196 to +150 °C (-320 to +302 °F) NOTICE Material fatigue due to excessive temperature difference! ▶ Maximum temperature difference of media used: 300 K	Order code for "Measuring tube mat., wetted surface", option LA

Dependency of ambient temperature on medium temperature

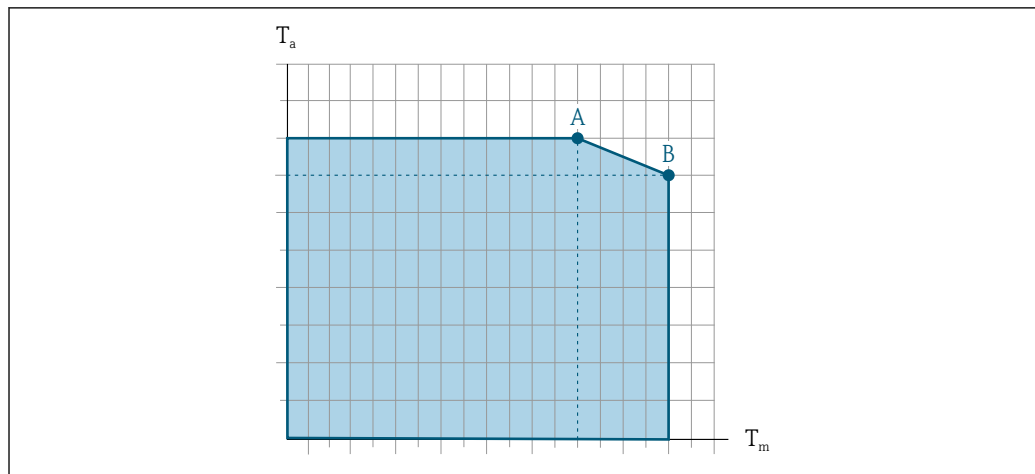

A0031121

24 Exemplary representation, values in the table below.

T_a Ambient temperature range

T_m Medium temperature

A Maximum permitted medium temperature T_m at $T_{a\ max} = 60\ ^\circ\text{C}$ (140 °F); higher medium temperatures T_m require a reduced ambient temperature T_a

B Maximum permitted ambient temperature T_a for the maximum specified medium temperature T_m of the sensor

i Values for devices used in the hazardous area:
Separate Ex documentation (XA) for the device → 106.

Version	Not insulated				Insulated			
	A		B		A		B	
	T_a	T_m	T_a	T_m	T_a	T_m	T_a	T_m
Standard version	60 °C (140 °F)	205 °C (401 °F)	-	-	60 °C (140 °F)	110 °C (230 °F)	50 °C (122 °F)	205 °C (401 °F)

Density 0 to 5 000 kg/m³ (0 to 312 lb/cf)

Pressure-temperature ratings

The following pressure/temperature diagrams apply to all pressure-bearing parts of the device and not just the process connection. The diagrams show the maximum permissible medium pressure depending on the specific medium temperature.

i Pressure-temperature curves with temperature range +151 to +205 °C (+304 to +401 °F) exclusively for extended temperature version of measuring devices.

Flange according to EN 1092-1 (DIN 2501)

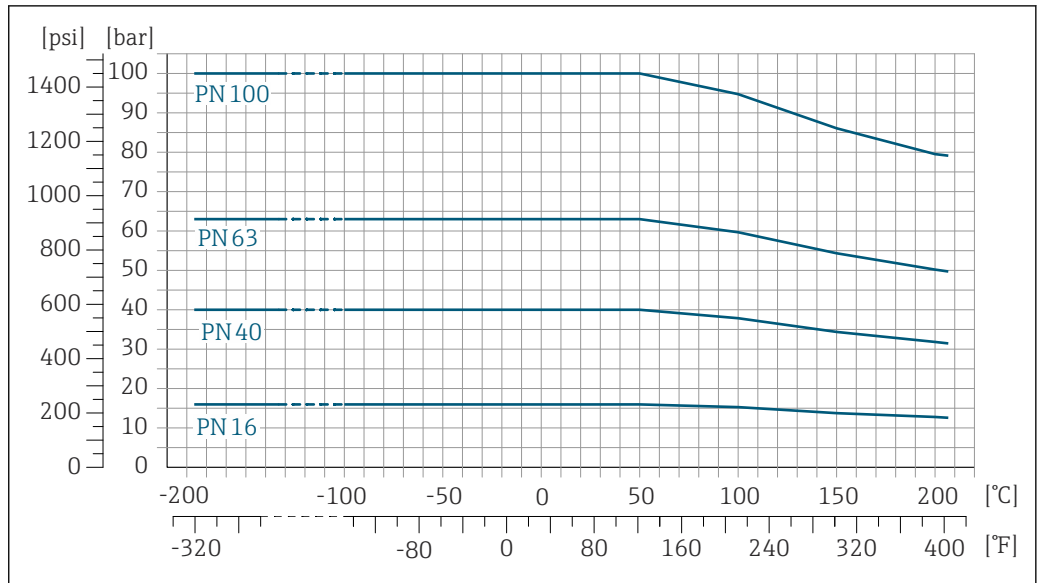

25 With flange material 1.4404 (F316/F316L)

Flange according to ASME B16.5

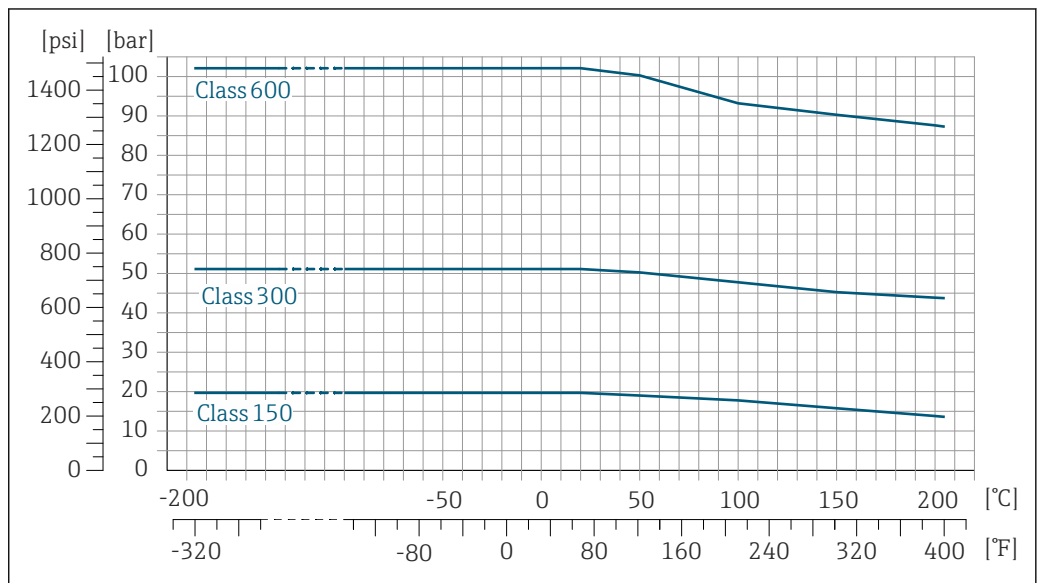

26 With flange material 1.4404 (F316/F316L)

Flange JIS B2220

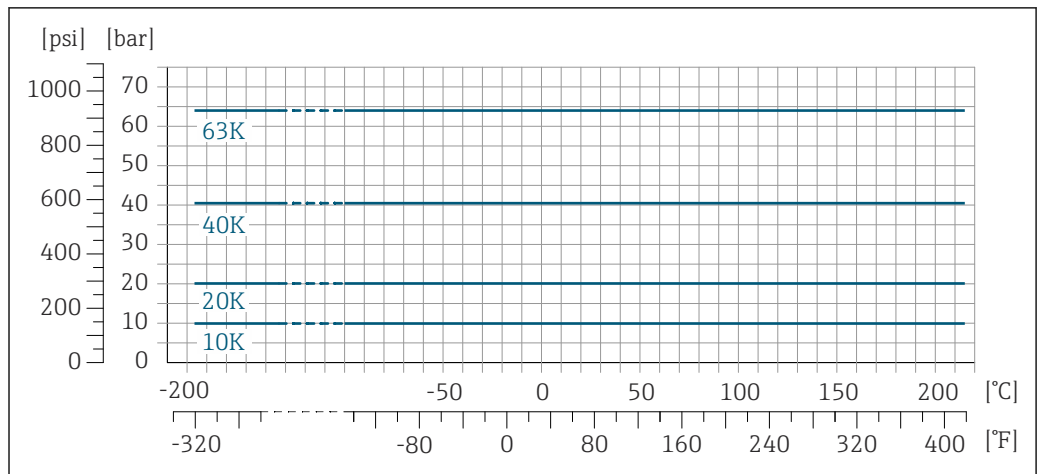

A0029639-EN

27 With flange material 1.4404 (F316/F316L)

Flange DIN 11864-2 Form A

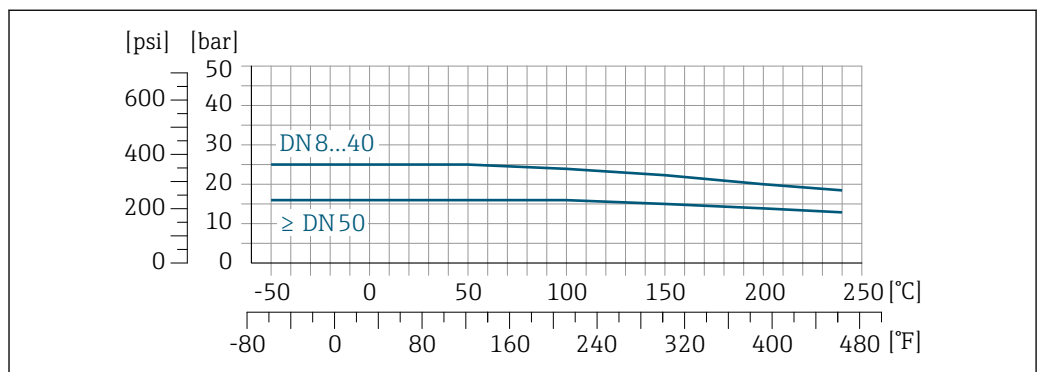

A0028782-EN

28 With connection material 1.4404 (316/316L)

Thread DIN 11851

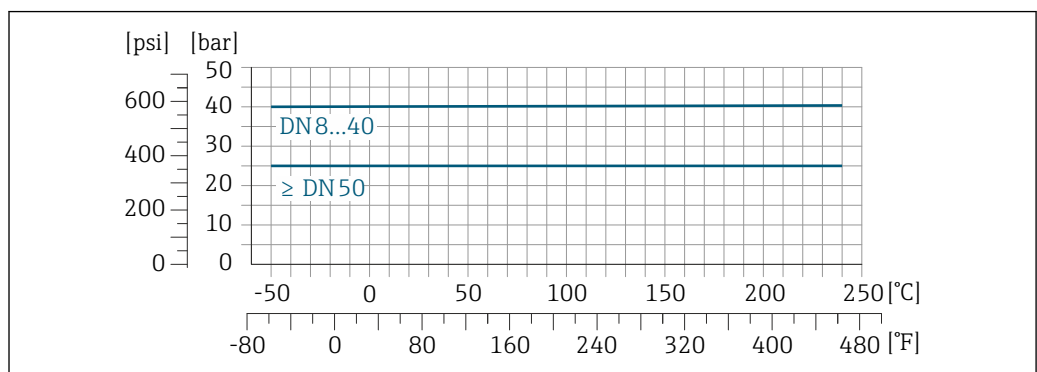

A0028794-EN

29 With connection material 1.4404 (316/316L)

DIN 11851 allows for applications up to +140 °C (+284 °F) if suitable sealing materials are used. Please take this into account when selecting seals and counterparts, as these components can limit the pressure and temperature range.

Thread ISO 2853

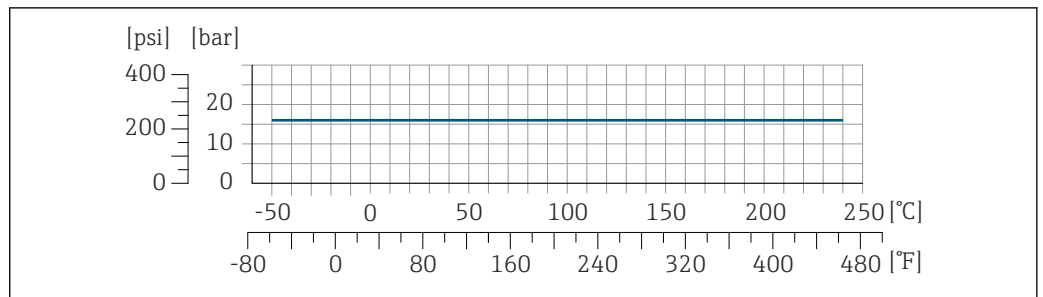

A0028799-EN

30 With connection material 1.4404 (316/316L)

Thread SMS 1145

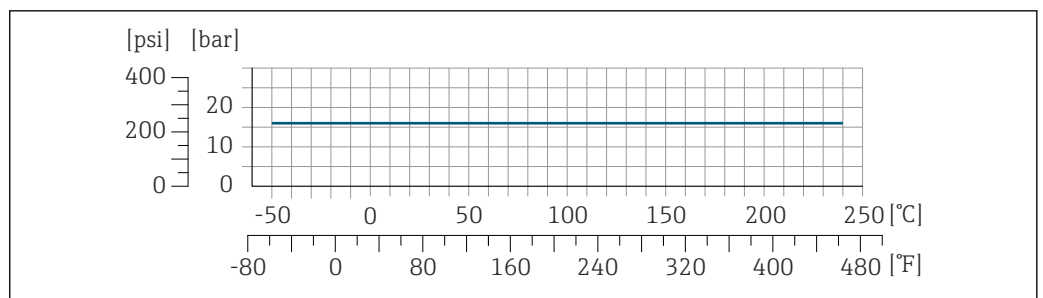

A0028800-EN

31 With connection material 1.4404 (316/316L)

SMS 1145 allows for applications up to 16 bar (232 psi) if suitable sealing materials are used. Please take this into account when selecting seals and counterparts, as these components can limit the pressure and temperature range.

Tri-Clamp

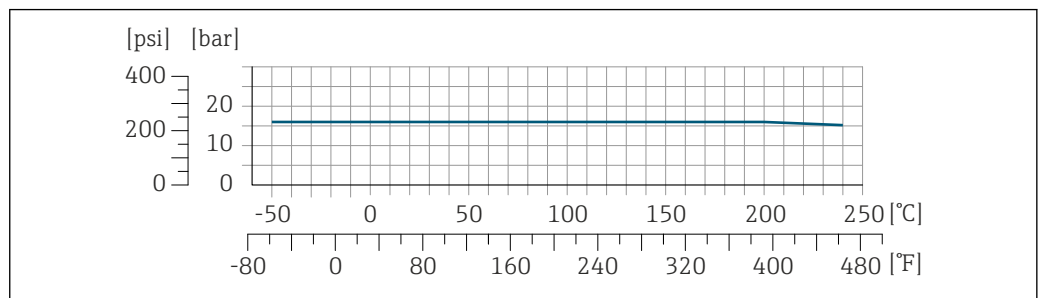

A0032216-EN

The clamp connections are suitable up to a maximum pressure of 16 bar (232 psi). Please observe the operating limits of the clamp and seal used as they can be over 16 bar (232 psi). The clamp and seal are not included in the scope of supply.

Sensor housing

The sensor housing is filled with helium and protects the electronics and mechanics inside.

i If a measuring tube fails (e.g. due to process characteristics like corrosive or abrasive fluids), the fluid will initially be contained by the sensor housing.

In the event of a tube failure, the pressure level inside the sensor housing will rise according to the operating process pressure. If the user judges that the sensor housing burst pressure does not provide an adequate safety margin, the device can be fitted with a rupture disk. This prevents excessively high pressure from forming inside the sensor housing. Therefore, the use of a rupture disk is strongly recommended in applications involving high gas pressures, and particularly in applications in which the process pressure is greater than 2/3 of the sensor housing burst pressure.

If there is a need to drain the leaking medium into a discharge device, the sensor should be fitted with a rupture disk. Connect the discharge to the additional threaded connection →  72.

If the sensor is to be purged with gas (gas detection), it should be equipped with purge connections.

 Do not open the purge connections unless the containment can be filled immediately with a dry, inert gas. The use of helium at low pressure is recommended for purging.

Maximum pressure: 0.5 bar (7.3 psi)

Burst pressure of the sensor housing

The following sensor housing burst pressures are only valid for standard devices and/or devices equipped with closed purge connections (not opened/as delivered).

If a device fitted with purge connections (order code for "Sensor option", option CH "Purge connection") is connected to the purge system, the maximum pressure is determined by the purge system itself or by the device, depending on which component has the lower pressure classification.

If the device is fitted with a rupture disk (order code for "Sensor option", option CA "Rupture disk"), the rupture disk trigger pressure is decisive.

The sensor housing burst pressure refers to a typical internal pressure which is reached prior to mechanical failure of the sensor housing and which was determined during type testing. The corresponding type test declaration can be ordered with the device (order code for "Additional approval", option LN "Sensor housing burst pressure, type test").

DN		Sensor housing burst pressure	
[mm]	[in]	[bar]	[psi]
25	1	220	3 191
50	2	160	2 320
80	3	150	2 175
100	4	120	1 740

For information on the dimensions: see the "Mechanical construction" section →  63

Rupture disk

To increase the level of safety, a device version with a rupture disk with a trigger pressure of 10 to 15 bar (145 to 217.5 psi) can be used (order code for "Sensor option", option "rupture disk").

For information on the dimensions: see the "Mechanical construction" section (accessories) →  72

Flow limit



Select the nominal diameter by optimizing between the required flow range and permissible pressure loss.

 For an overview of the full scale values for the measuring range, see the "Measuring range" section →  10

- The minimum recommended full scale value is approx. 1/20 of the maximum full scale value
- In most applications, 20 to 50 % of the maximum full scale value can be considered ideal
- A low full scale value must be selected for abrasive media (such as liquids with entrained solids): flow velocity < 1 m/s (< 3 ft/s).

 To calculate the flow limit, use the *Applicator* sizing tool →  105

Pressure loss

 To calculate the pressure loss, use the *Applicator* sizing tool →  105

System pressure

It is important that cavitation does not occur, or that gases entrained in the liquids do not outgas. This is prevented by means of a sufficiently high system pressure.

For this reason, the following mounting locations are recommended:

- At the lowest point in a vertical pipe
- Downstream from pumps (no danger of vacuum)

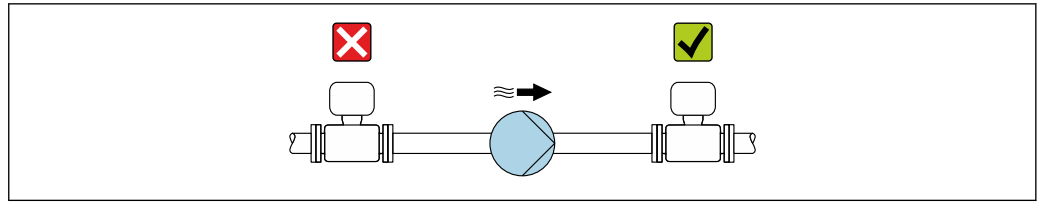

A0028777

Thermal insulation

In the case of some fluids, it is important to keep the heat radiated from the sensor to the transmitter to a low level. A wide range of materials can be used for the required insulation.

NOTICE

Electronics overheating on account of thermal insulation!

- ▶ Recommended orientation: horizontal orientation, transmitter housing pointing downwards.
- ▶ Do not insulate the transmitter housing .
- ▶ Maximum permissible temperature at the lower end of the transmitter housing: 80 °C (176 °F)
- ▶ Thermal insulation with extended neck free: We recommend that you do not insulate the extended neck in order to ensure optimum dissipation of heat.

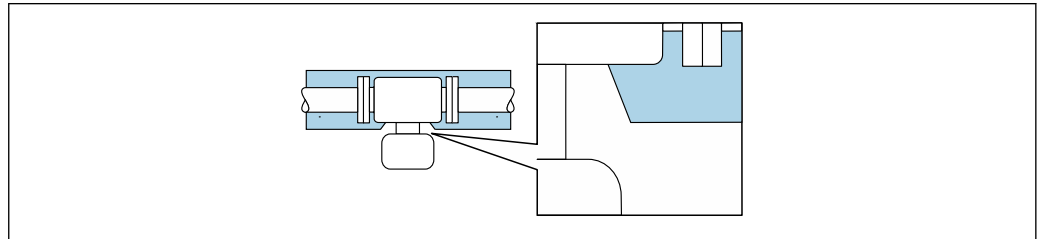

A0034391

32 Thermal insulation with extended neck free

i Low-temperature version: It is generally not necessary to insulate the transmitter housing . If insulation is provided, the rules that apply are the same as those for thermal insulation.

Heating

Some fluids require suitable measures to avoid loss of heat at the sensor.

Heating options

- Electrical heating, e.g. with electric band heaters
- Via pipes carrying hot water or steam
- Via heating jackets

NOTICE

Danger of overheating when heating

- ▶ Ensure that the temperature at the lower end of the transmitter housing does not exceed 80 °C (176 °F).
- ▶ Ensure that sufficient convection takes place at the transmitter neck.
- ▶ When using in potentially explosive atmospheres, observe the information in the device-specific Ex documentation. For detailed information on the temperature tables, see the separate document entitled "Safety Instructions" (XA) for the device.

Vibrations

The operational reliability of the measuring system is not affected by plant vibrations.

Custody transfer measurement

The measuring device is optionally tested in accordance with OIML R117/R81 and has an EU type evaluation certificate which authorizes the use in EU type-examination certificates according to Measuring Instruments Directive 2014/32/EU for service subject to legal metrological control ("custody transfer") for liquids other than water and cryogenic liquids (Annex VII).

The permitted fluid temperature in these applications is -200 to $+90$ °C (-328 to $+194$ °F).

The device is used with a legally controlled totalizer on the local display and optionally with legally controlled outputs.

Measuring devices subject to legal metrological control totalize in both directions, i.e. all the outputs consider flow components in the positive (forward) and negative (reverse) flow direction.

Generally a measuring device subject to legal metrological control is secured against tampering by seals on the transmitter or sensor. These seals may normally only be opened by a representative of the competent authority for legal metrology controls.

After putting the device into circulation or after sealing the device, operation is only possible to a limited extent.

Detailed ordering information is available from your local Endress+Hauser sales center for national approvals, which are based on the OIML certificates, for applications with liquids other than water or cryogenic liquids.

Mechanical construction

Dimensions in SI units

Compact version

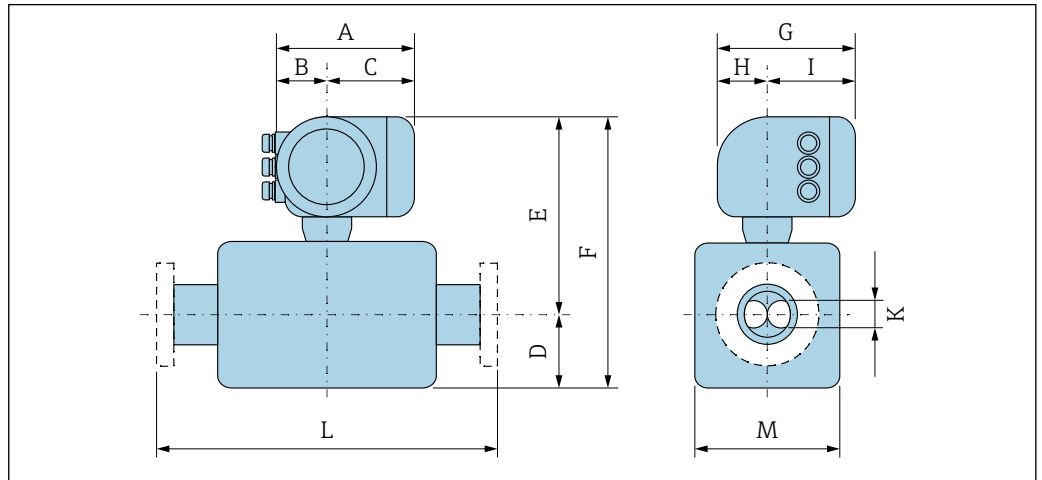

A0033786

Order code for "Housing", option A "Aluminum, coated"

DN	A ¹⁾	B ¹⁾	C	D	E	F	G ²⁾	H	I ²⁾	K	L	M
[mm]	[mm]	[mm]	[mm]	[mm]	[mm]	[mm]	[mm]	[mm]	[mm]	[mm]	[mm]	[mm]
25	169	68	101	217	331.5	548.5	200	59	141	15.2	³⁾	73
50	169	68	101	408	352	760	200	59	141	28.0	³⁾	115
80	169	68	101	524	379	903	200	59	141	43.3	³⁾	169
100	169	68	101	655	405	1060	200	59	141	68.9	³⁾	220

- 1) Depending on the cable gland used: values up to + 30 mm
- 2) For version without local display: values - 30 mm
- 3) Depends on the particular process connection

Order code for "Housing", option A "Aluminum, coated"; Ex d

DN	A ¹⁾	B ¹⁾	C	D	E	F	G ²⁾	H	I ²⁾	K	L	M
[mm]	[mm]	[mm]	[mm]	[mm]	[mm]	[mm]	[mm]	[mm]	[mm]	[mm]	[mm]	[mm]
25	188	85	103	217	361.5	578.5	217	58	159	15.2	³⁾	73
50	188	85	103	408	382	790	217	58	159	28.0	³⁾	115
80	188	85	103	524	409	933	217	58	159	43.3	³⁾	169
100	188	85	103	655	435	1090	217	58	159	68.9	³⁾	220

- 1) Depending on the cable gland used: values up to + 30 mm
- 2) For version without local display: values - 40 mm
- 3) Depends on the particular process connection

Order code for "Housing", option B "Stainless, hygienic"

DN	A ¹⁾	B ¹⁾	C	D	E	F	G ²⁾	H	I ²⁾	K	L	M
[mm]	[mm]	[mm]	[mm]	[mm]	[mm]	[mm]	[mm]	[mm]	[mm]	[mm]	[mm]	[mm]
25	183	73	110	217	331.5	548.5	207	65	142	15.2	³⁾	73
50	183	73	110	408	352	760	207	65	142	28.0	³⁾	115

DN	A ¹⁾	B ¹⁾	C	D	E	F	G ²⁾	H	I ²⁾	K	L	M
[mm]	[mm]	[mm]	[mm]	[mm]	[mm]	[mm]	[mm]	[mm]	[mm]	[mm]	[mm]	[mm]
80	183	73	110	524	379	903	207	65	142	43.3	³⁾	169
100	183	73	110	655	405	1060	207	65	142	68.9	³⁾	220

- 1) Depending on the cable gland used: values up to + 30 mm
- 2) For version without local display: values - 13 mm
- 3) Depends on the particular process connection

Order code for "Housing", option L "Cast, stainless"

DN	A ¹⁾	B	C	D	E	F	G	H	I	K	L	M
[mm]	[mm]	[mm]	[mm]	[mm]	[mm]	[mm]	[mm]	[mm]	[mm]	[mm]	[mm]	[mm]
25	186	85	101	217	361.5	578.5	221	63	158	15.2	²⁾	73
50	186	85	101	408	382	790	221	63	158	28.0	²⁾	115
80	186	85	101	524	409	933	221	63	158	43.3	²⁾	169
100	186	85	101	655	435	1090	221	63	158	68.9	²⁾	220

- 1) Depending on the cable gland used: values up to + 30 mm
- 2) Depends on the particular process connection

Flange connections

Fixed flange connections EN 1092-1, ASME B16.5, JIS B2220

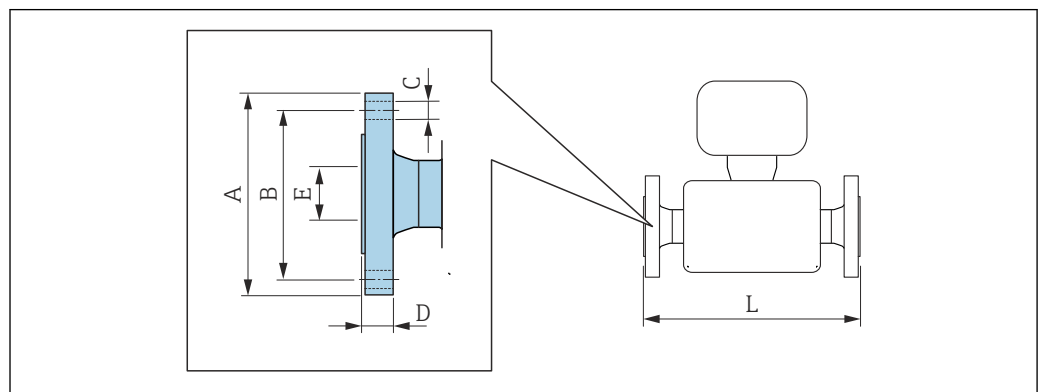

A0015621

i Length tolerance for dimension L in mm:
+1.5 / -2.0

Flange according to EN 1092-1 (DIN 2501 / DIN 2512N): PN16 1.4404 (F316/F316L): order code for "Process connection", option D1S						
Flange with groove according to EN 1092-1 Form D (DIN 2512N): PN16 1.4404 (F316/F316L): order code for "Process connection", option D5S						
DN	A	B	C	D	E	L
[mm]	[mm]	[mm]	[mm]	[mm]	[mm]	[mm]
100	220	180	8 × ø18	20	107.1	1128
Surface roughness (flange): EN 1092-1 Form B1 (DIN 2526 Form C), Ra 3.2 to 12.5 µm						

Flange according to EN 1092-1 (DIN 2501): PN16 with reduction in nominal diameter 1.4404 (F316/F316L)

Flange DN [mm]	Device reduction to DN [mm]	Order code "Process connection", Option	A [mm]	B [mm]	C [mm]	D [mm]	E [mm]	L [mm]
100	80	DHS	220	180	8 × Ø18	20	107.1	874

Surface roughness (flange): EN 1092-1 Form B1 (DIN 2526 Form C), Ra 3.2 to 12.5 µm

Flange according to EN 1092-1 (DIN 2501 / DIN 2512N): PN 40 1.4404 (F316/F316L): order code for "Process connection", option D2S

Flange with groove according to EN 1092-1 Form D (DIN 2512N): PN 40 1.4404 (F316/F316L): order code for "Process connection", option D6S

DN [mm]	A [mm]	B [mm]	C [mm]	D [mm]	E [mm]	L [mm]
25	115	85	4 × Ø14	18	28.5	440
50	165	125	4 × Ø18	20	54.5	715
80	200	160	8 × Ø18	24	82.5	840
100	235	190	8 × Ø22	24	107.1	1128

Surface roughness (flange): EN 1092-1 Form B1 (DIN 2526 Form C), Ra 3.2 to 12.5 µm

Flange according to EN 1092-1 (DIN 2501): PN 40 with reduction in nominal diameter 1.4404 (F316/F316L)

Flange DN [mm]	Device reduction to DN [mm]	Order code "Process connection", Option	A [mm]	B [mm]	C [mm]	D [mm]	E [mm]	L [mm]
80	50	DGS	200	160	8 × Ø18	24	82.5	840
100	80	DIS	235	190	8 × Ø22	24	107.1	874

Surface roughness (flange): EN 1092-1 Form B1 (DIN 2526 Form C), Ra 3.2 to 12.5 µm

Flange according to EN 1092-1 (DIN 2501 / DIN 2512N): PN 63 1.4404 (F316/F316L): order code for "Process connection", option D3S

Flange with groove according to EN 1092-1 Form D (DIN 2512N): PN 63 1.4404 (F316/F316L): order code for "Process connection", option D7S

DN [mm]	A [mm]	B [mm]	C [mm]	D [mm]	E [mm]	L [mm]
50	180	135	4 × Ø22	26	54.5	724
80	215	170	8 × Ø22	28	81.7	875
100	250	200	8 × Ø26	30	106.3	1128

Surface roughness (flange): EN 1092-1 Form B1 (DIN 2526 Form C), Ra 3.2 to 12.5 µm

Flange according to EN 1092-1 (DIN 2501 / DIN 2512N): PN 100 1.4404 (F316/F316L): <i>order code for "Process connection", option D4S</i>						
Flange with groove according to EN 1092-1 Form D (DIN 2512N): PN 100 1.4404 (F316/F316L): <i>order code for "Process connection", option D8S</i>						
DN [mm]	A [mm]	B [mm]	C [mm]	D [mm]	E [mm]	L [mm]
25	140	100	4 × Ø18	24	28.5	470
50	195	145	4 × Ø26	28	53.9	740
80	230	180	8 × Ø26	32	80.9	885
100	265	210	8 × Ø30	36	104.3	1128
Surface roughness (flange): EN 1092-1 Form B2 (DIN 2526 Form E), Ra 0.8 to 3.2 µm						

Flange according to ASME B16.5: Class 150 1.4404 (F316/F316L) <i>Order code for "Process connection", option AAS</i>						
DN [mm]	A [mm]	B [mm]	C [mm]	D [mm]	E [mm]	L [mm]
25	110	79.4	4 × Ø15.7	14.2	26.7	440
50	150	120.7	4 × Ø19.1	19.1	52.6	715
80	190	152.4	4 × Ø19.1	23.9	78.0	840
100	230	190.5	8 × Ø19.1	23.9	102.4	1128
Surface roughness (flange): Ra 3.2 to 6.3 µm						

Flange according to ASME B16.5: Class 150 with reduction in nominal diameter 1.4404 (F316/F316L)								
Flange DN [mm]	Device reduction to DN [mm]	Order code "Process connection", Option	A [mm]	B [mm]	C [mm]	D [mm]	E [mm]	L [mm]
80	50	AJS	190	152.4	4 × Ø19.1	23.9	78.0	720
100	80	ALS	230	190.5	8 × Ø19.1	23.9	102.4	874
Surface roughness (flange): Ra 3.2 to 6.3 µm								

Flange according to ASME B16.5: Class 300 1.4404 (F316/F316L) <i>Order code for "Process connection", option ABS</i>						
DN [mm]	A [mm]	B [mm]	C [mm]	D [mm]	E [mm]	L [mm]
25	125	88.9	4 × Ø19.1	17.5	26.7	440
50	165	127	8 × Ø19.1	22.3	52.6	715
80	210	168.3	8 × Ø22.3	28.4	78.0	840
100	255	200	8 × Ø22.3	31.7	102.4	1128
Surface roughness (flange): Ra 3.2 to 6.3 µm						

Flange according to ASME B16.5: Class 300 with reduction in nominal diameter 1.4404 (F316/F316L)								
Flange DN [mm]	Device reduction to DN [mm]	Order code "Process connection", Option	A [mm]	B [mm]	C [mm]	D [mm]	E [mm]	L [mm]
80	50	AKS	210	168.3	8 × Ø22.3	28.4	78.0	732
100	80	AMS	255	200	8 × Ø22.3	31.7	102.4	894
Surface roughness (flange): Ra 3.2 to 6.3 µm								

Flange according to ASME B16.5: Class 600 1.4404 (F316/F316L) Order code for "Process connection", option ACS						
DN [mm]	A [mm]	B [mm]	C [mm]	D [mm]	E [mm]	L [mm]
25	125	88.9	4 × Ø19.1	23.9	24.3	490
50	165	127	8 × Ø19.1	31.8	49.2	742
80	210	168.3	8 × Ø22.2	40.0	73.7	900
100	275	215.9	8 × Ø25.4	48.4	97.3	1158
Surface roughness (flange): Ra 3.2 to 6.3 µm						

Flange JIS B2220: 10K 1.4404 (F316/F316L) Order code for "Process connection", option NDS						
DN [mm]	A [mm]	B [mm]	C [mm]	D [mm]	E [mm]	L [mm]
50	155	120	4 × Ø19	16	50	715
80	185	150	8 × Ø19	18	80	832
100	210	175	8 × Ø19	18	100	1128
Surface roughness (flange): Ra 3.2 to 6.3 µm						

Flange JIS B2220: 20K 1.4404 (F316/F316L) Order code for "Process connection", option NES						
DN [mm]	A [mm]	B [mm]	C [mm]	D [mm]	E [mm]	L [mm]
25	125	90	4 × Ø19	16	25	440
50	155	120	8 × Ø19	18	50	715
80	200	160	8 × Ø23	22	80	832
100	225	185	8 × Ø23	24	100	1128
Surface roughness (flange): Ra 1.6 to 3.2 µm						

Flange JIS B2220: 40K 1.4404 (F316/F316L) Order code for "Process connection", option NGS						
DN [mm]	A [mm]	B [mm]	C [mm]	D [mm]	E [mm]	L [mm]
25	130	95	4 × Ø19	22	25	485
50	165	130	8 × Ø19	26	50	760

Flange JIS B2220: 40K 1.4404 (F316/F316L) <i>Order code for "Process connection", option NGS</i>						
DN [mm]	A [mm]	B [mm]	C [mm]	D [mm]	E [mm]	L [mm]
80	210	170	8 × Ø23	32	75	890
100	250	205	8 × Ø25	36	100	1168
Surface roughness (flange): Ra 1.6 to 3.2 µm						

Flange JIS B2220: 63K 1.4404 (F316/F316L) <i>Order code for "Process connection", option NHS</i>						
DN [mm]	A [mm]	B [mm]	C [mm]	D [mm]	E [mm]	L [mm]
25	140	100	4 × Ø23	27	22	494
50	185	145	8 × Ø23	34	48	775
80	230	185	8 × Ø25	40	73	915
100	270	220	8 × Ø27	44	98	1168
Surface roughness (flange): Ra 1.6 to 3.2 µm						

Fixed flange DIN 11864-2

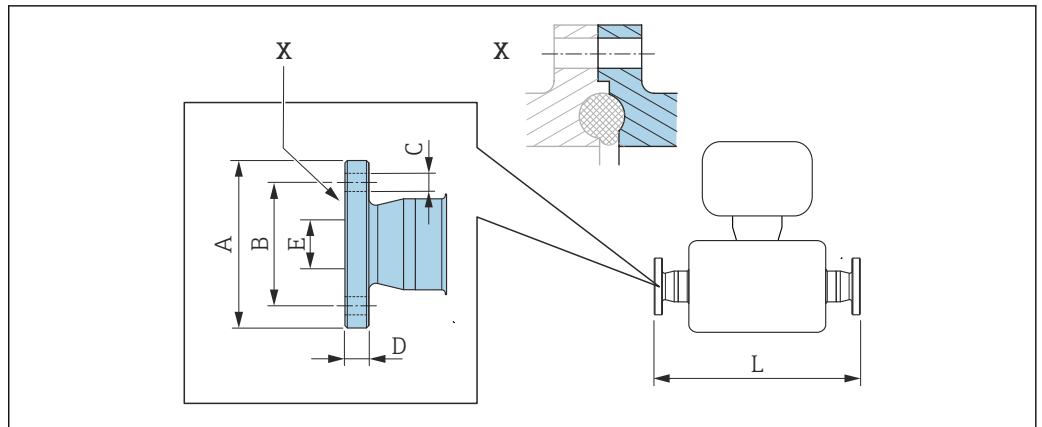

A0015627

33 Detail X: Asymmetrical process connection; the part shown in blue is provided by the supplier.

i Length tolerance for dimension L in mm:
+1.5 / -2.0

Flange DIN11864-2 Form A, for pipe according to DIN11866 series A, flange with notch 1.4404 (316/316L)

Order code for "Process connection", option KCS

DN [mm]	A [mm]	B [mm]	C [mm]	D [mm]	E [mm]	L [mm]
25	70	53	4 × Ø9	10	26	454
50	94	77	4 × Ø9	10	50	720
80	133	112	8 × Ø11	12	81	900
100	159	137	8 × Ø11	14	100	1128

3A version available: order code for "Additional approval", option LP in conjunction with $Ra_{max} = 0.76 \mu\text{m}$: order code for "Measuring tube material", option SB

Flange DIN11864-2 Form A, for pipe according to DIN11866 series A, flange with notch with nominal diameter reduction 1.4404 (316/316L)

Order code for "Process connection", option KAS

Flange DN [mm]	Device reduction to DN [mm]	A [mm]	B [mm]	C [mm]	D [mm]	E [mm]	L [mm]
40	25	82	65	4 × Ø9	10	38	454

3A version available: order code for "Additional approval", option LP in conjunction with $Ra_{max} = 0.76 \mu\text{m}$: order code for "Measuring tube material", option SB

Clamp connections

Tri-Clamp

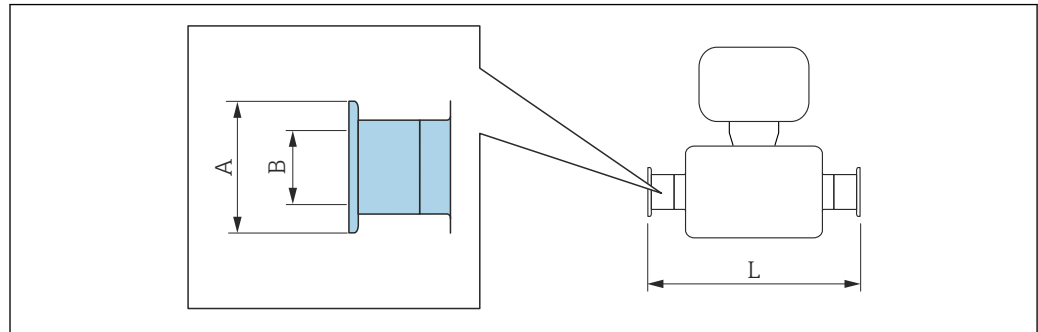

A0015625

i Length tolerance for dimension L in mm:
+1.5 / -2.0

Tri-Clamp for pipe according to DIN 11866 series C 1.4404 (316/316L)

Order code for "Process connection", option FTS

DN [mm]	Clamp [in]	A [mm]	B [mm]	L [mm]
25	1	50.4	22.1	434
50	2	63.9	47.5	720
80	3	90.9	72.9	900
100	4	118.9	97.4	1128

3A version available: order code for "Additional approval", option LP in conjunction with
Ra_{max} = 0.76 μm: order code for "Measuring tube material", option SB

Tri-Clamp (1½), for pipe according to DIN 11866 series C with nominal diameter reduction 1.4404 (316L)

Order code for "Process connection", option FAS

Tri-Clamp DN [mm]	Device reduction to DN [mm]	Clamp [in]	A [mm]	B [mm]	L [mm]
40	25	1½ ¹⁾	50.4	34.80	434

3A version available: order code for "Additional approval", option LP in conjunction with
Ra_{max} = 0.76 μm: order code for "Measuring tube material", option SB

1) The connection corresponds to the hygienic clamp dimensions as per ASME BPE.

Couplings

Thread DIN 11851, DIN11864-1, SMS 1145

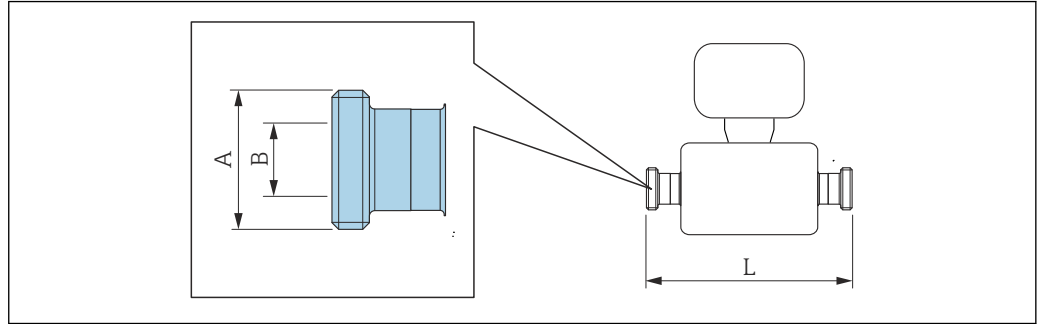

A0015628

i Length tolerance for dimension L in mm:
+1.5 / -2.0

Thread DIN 11851, for pipe according to DIN11866, series A 1.4404 (316/316L) Order code for "Process connection", option FMW			
DN [mm]	A [in]	B [mm]	L [mm]
25	Rd 52 × 1/6	26	434
50	Rd 78 × 1/6	50	720
80	Rd 110 × 1/4	81	900
100	Rd 130 × 1/4	100	1128

3A version available: order code for "Additional approval", option LP in conjunction with Ra_{max} = 0.76 µm: order code for "Measuring tube material", option SB

Thread DIN11864-1 Form A, for pipe according to DIN11866, series A 1.4404 (316/316L) Order code for "Process connection", option FLW			
DN [mm]	A [in]	B [mm]	L [mm]
25	Rd 52 × 1/8	26	434
50	Rd 78 × 1/6	50	720
80	Rd 110 × 1/4	81	900
100	Rd 130 × 1/4	100	1128

3A version available: order code for "Additional approval", option LP in conjunction with Ra_{max} = 0.76 µm: order code for "Measuring tube material", option SB

Thread SMS 1145 1.4404 (316/316L) Order code for "Process connection", option SCS			
DN [mm]	A [in]	B [mm]	L [mm]
25	Rd 40 × 1/6	22.6	434
50	Rd 70 × 1/6	48.6	720
80	Rd 98 × 1/6	72.9	900

Thread SMS 1145 1.4404 (316/316L) <i>Order code for "Process connection", option SCS</i>			
DN [mm]	A [in]	B [mm]	L [mm]
100	Rd 132 × 1/6	97.6	1128
3A version available: order code for "Additional approval", option LP in conjunction with Ra _{max} = 0.76 µm: order code for "Measuring tube material", option SB			

Accessories

Rupture disk/purge connections

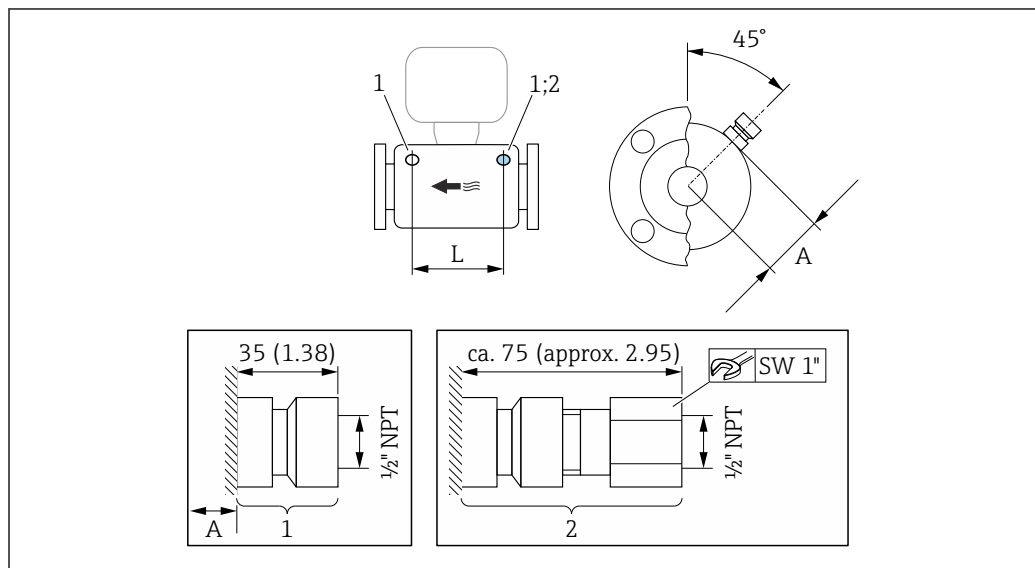

34 Engineering unit mm (in)

- 1 Connection nipple for purge connections: order code for "Sensor options", option CH "Purge connection"
- 2 Connection nipple with rupture disk: order code for "Sensor option", option CA "Rupture disk"

DN	A	L
[mm]	[mm]	[mm]
25	32	240
50	53	452
80	80	380
100	106	584

Protective cover

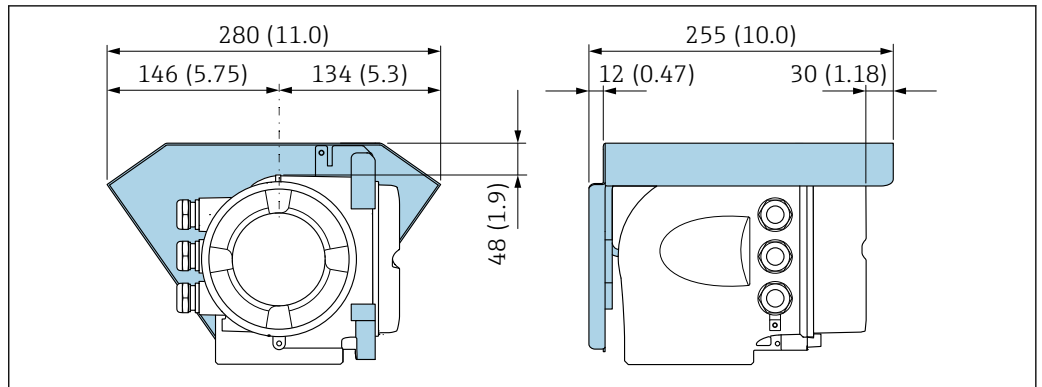

A0029553

35 Engineering unit mm (in)

Remote display and operating module DKX001

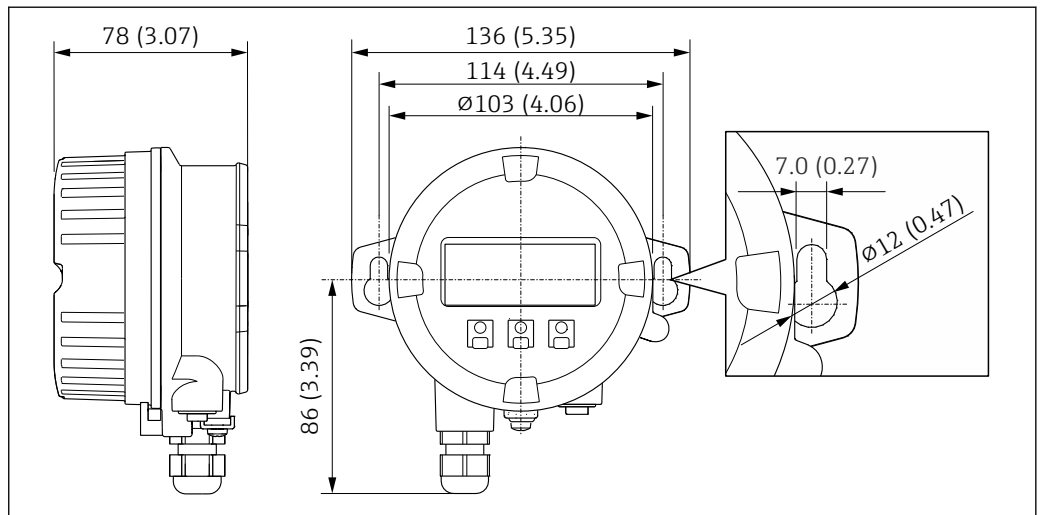

A0028921

36 Engineering unit mm (in)

External WLAN antenna

i The external WLAN antenna is not suitable for use in hygienic applications.

External WLAN antenna mounted on device

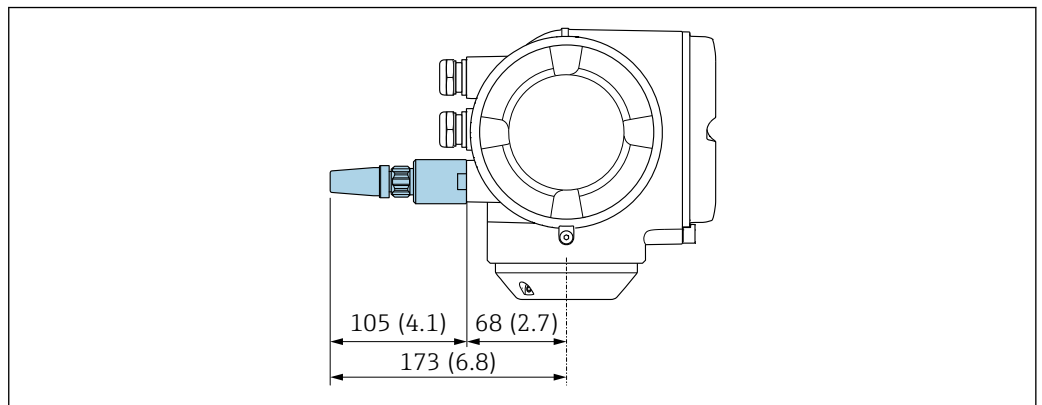

A0028923

37 Engineering unit mm (in)

External WLAN antenna mounted with cable

The external WLAN antenna can be mounted separately from the transmitter if the transmission/reception conditions at the transmitter mounting location are poor.

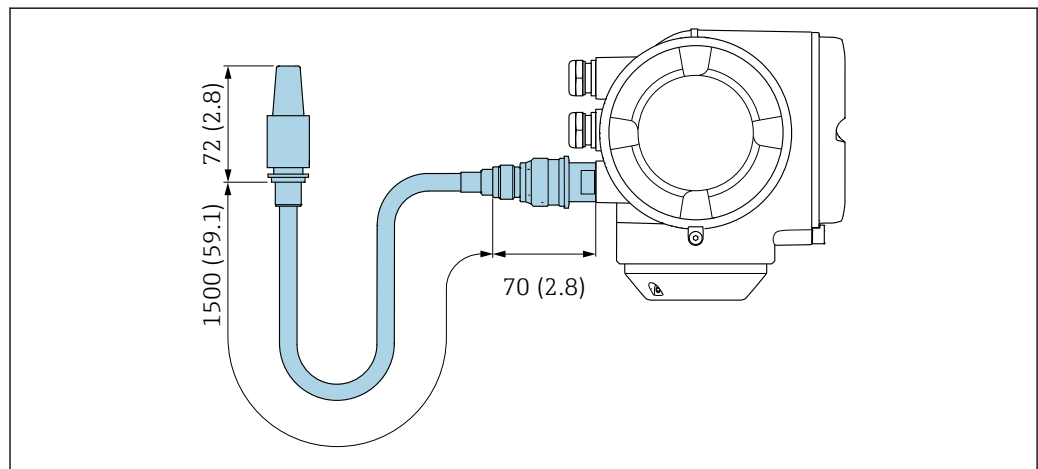

38 Engineering unit mm (in)

Dimensions in US units

Compact version

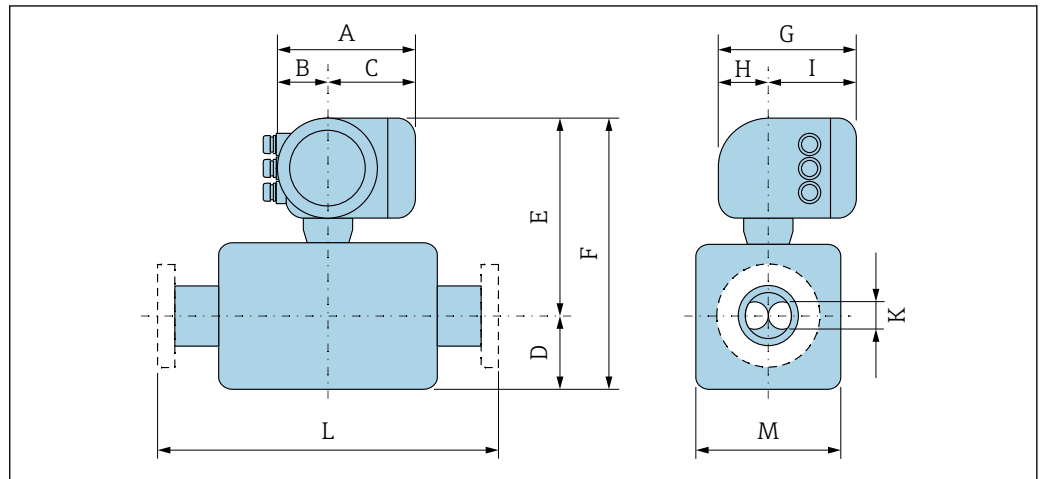

Order code for "Housing", option A "Aluminum, coated"

DN	A ¹⁾	B ¹⁾	C	D	E	F	G ²⁾	H	I ²⁾	K	L	M
[in]	[in]	[in]	[in]	[in]	[in]	[in]	[in]	[in]	[in]	[in]	[in]	[in]
1	6.65	2.68	3.98	8.54	13.05	21.60	7.87	2.32	5.55	0.60	³⁾	2.87
2	6.65	2.68	3.98	16.06	13.86	29.92	7.87	2.32	5.55	1.10	³⁾	4.53
3	6.65	2.68	3.98	20.63	14.92	35.55	7.87	2.32	5.55	1.70	³⁾	6.65
4	6.65	2.68	3.98	25.79	15.95	41.73	7.87	2.32	5.55	2.71	³⁾	8.66

- 1) Depending on the cable gland used: values up to + 1.18 in
- 2) For version without local display: values - 1.18 in
- 3) Depends on the particular process connection

Order code for "Housing", option A "Aluminum, coated"; Ex d

DN	A ¹⁾	B	C	D	E	F	G ²⁾	H	I	K	L	M
[in]	[in]	[in]	[in]	[in]	[in]	[in]	[in]	[in]	[in]	[in]	[in]	[in]
1	7.40	3.35	4.06	8.54	14.23	22.78	8.54	2.28	6.26	0.60	³⁾	2.87
2	7.40	3.35	4.06	16.06	15.04	31.10	8.54	2.28	6.26	1.10	³⁾	4.53
3	7.40	3.35	4.06	20.63	16.10	36.73	8.54	2.28	6.26	1.70	³⁾	6.65
4	7.40	3.35	4.06	25.79	17.13	42.91	8.54	2.28	6.26	2.71	³⁾	8.66

- 1) Depending on the cable gland used: values up to + 1.18 in
- 2) For version without local display: values - 1.57 in
- 3) Depends on the particular process connection

Order code for "Housing", option B "Stainless, hygienic"

DN	A ¹⁾	B	C	D	E	F	G ²⁾	H	I	K	L	M
[in]	[in]	[in]	[in]	[in]	[in]	[in]	[in]	[in]	[in]	[in]	[in]	[in]
1	7.20	2.87	4.33	8.54	13.05	21.60	8.15	2.56	5.59	0.60	³⁾	2.87
2	7.20	2.87	4.33	16.06	13.86	29.92	8.15	2.56	5.59	1.10	³⁾	4.53

DN	A ¹⁾	B	C	D	E	F	G ²⁾	H	I	K	L	M
[in]	[in]	[in]	[in]	[in]	[in]	[in]	[in]	[in]	[in]	[in]	[in]	[in]
3	7.20	2.87	4.33	20.63	14.92	35.55	8.15	2.56	5.59	1.70	³⁾	6.65
4	7.20	2.87	4.33	25.79	15.95	41.73	8.15	2.56	5.59	2.71	³⁾	8.66

- 1) Depending on the cable gland used: values up to + 1.18 in
- 2) For version without local display: values - 0.51 in
- 3) Depends on the particular process connection

Order code for "Housing", option L "Cast, stainless"

DN	A ¹⁾	B	C	D	E	F	G	H	I	K	L	M
[in]	[in]	[in]	[in]	[in]	[in]	[in]	[in]	[in]	[in]	[in]	[in]	[in]
1	7.32	3.35	3.98	8.54	14.23	22.78	8.7	2.48	6.22	0.60	²⁾	2.87
2	7.32	3.35	3.98	16.06	15.04	31.10	8.7	2.48	6.22	1.10	²⁾	4.53
3	7.32	3.35	3.98	20.63	16.10	36.73	8.7	2.48	6.22	1.70	²⁾	6.65
4	7.32	3.35	3.98	25.79	17.13	42.91	8.7	2.48	6.22	2.71	²⁾	8.66

- 1) Depending on the cable gland used: values up to + 1.18 mm
- 2) Depends on the particular process connection

Fixed flange connections ASME B16.5

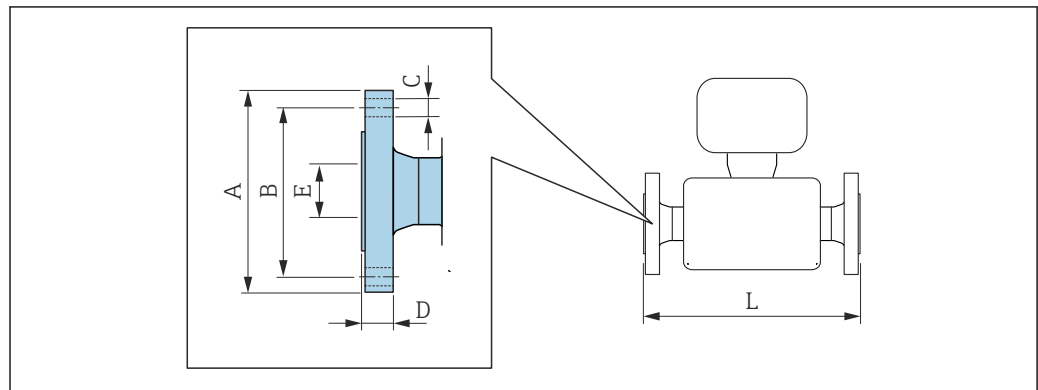

A0015621

i Length tolerance for dimension L in inch:
+0.06 / -0.08

Flange according to ASME B16.5: Class 150 1.4404 (F316/F316L) Order code for "Process connection", option AAS						
DN	A	B	C	D	E	L
[in]	[in]	[in]	[in]	[in]	[in]	[in]
1	4.33	3.13	4 × Ø0.62	0.56	1.05	17.32
2	5.91	4.75	4 × Ø0.75	0.75	2.07	28.15
3	7.48	6.00	4 × Ø0.75	0.94	3.07	33.07
4	9.06	7.50	8 × Ø0.75	0.94	4.03	44.41

Surface roughness (flange): Ra 126 to 248 µin

Flange according to ASME B16.5: Class 150 with reduction in nominal diameter 1.4404 (F316/F316L)								
Flange DN [in]	Device reduction to DN [in]	Order code "Process connection", Option	A [in]	B [in]	C [in]	D [in]	E [in]	L [in]
3	2	AJS	7.48	6	4 × Ø0.75	0.94	3.07	28.35
4	3	ALS	9.06	7.5	8 × Ø0.75	0.94	4.03	34.41
Surface roughness (flange): Ra 126 to 248 µin								

Flange according to ASME B16.5: Class 300 1.4404 (F316/F316L) Order code for "Process connection", option ABS						
DN [in]	A [in]	B [in]	C [in]	D [in]	E [in]	L [in]
1	4.92	3.50	4 × Ø0.75	0.69	1.05	17.32
2	6.50	5.00	8 × Ø0.75	0.88	2.07	28.15
3	8.27	6.63	8 × Ø0.88	1.12	3.07	33.07
4	10.04	7.87	8 × Ø0.88	1.25	4.03	44.41
Surface roughness (flange): Ra 126 to 248 µin						

Flange according to ASME B16.5: Class 300 with reduction in nominal diameter 1.4404 (F316/F316L)								
Flange DN [in]	Device reduction to DN [in]	Order code "Process connection", Option	A [in]	B [in]	C [in]	D [in]	E [in]	L [in]
3	2	AKS	8.27	6.63	8 × Ø0.88	1.12	3.07	28.82
4	3	AMS	10.04	7.87	8 × Ø0.88	1.25	4.03	35.2
Surface roughness (flange): Ra 126 to 248 µin								

Flange according to ASME B16.5: Class 600 1.4404 (F316/F316L) Order code for "Process connection", option ACS						
DN [in]	A [in]	B [in]	C [in]	D [in]	E [in]	L [in]
1	4.92	3.50	4 × Ø0.75	0.94	0.96	19.29
2	6.50	5.00	8 × Ø0.75	1.25	1.94	29.21
3	8.27	6.63	8 × Ø0.87	1.57	2.90	35.43
4	10.83	8.50	8 × Ø1.00	1.91	3.83	45.59
Surface roughness (flange): Ra 126 to 248 µin						

Clamp connections

Tri-Clamp

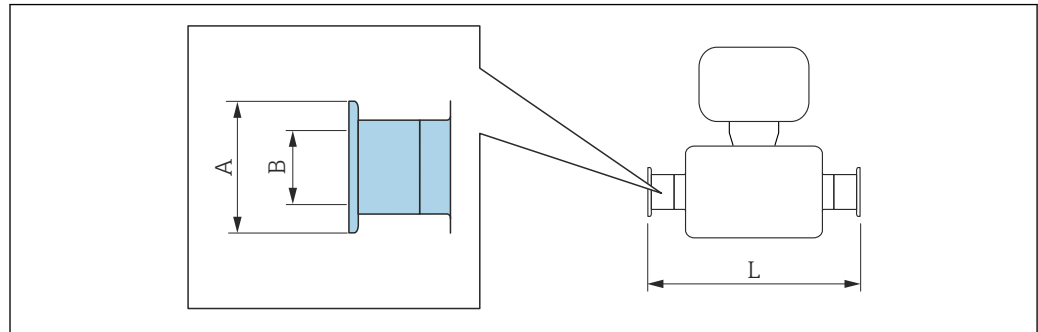

A0015625

i Length tolerance for dimension L in inch:
+0.06 / -0.08

Tri-Clamp for pipe according to DIN 11866 series C 1.4404 (316/316L)

Order code for "Process connection", option FTS

DN [in]	Clamp [in]	A [in]	B [in]	L [in]
1	1	1.98	0.87	17.09
2	2	2.52	1.87	28.35
3	3	3.58	2.87	35.43
4	4	4.68	3.83	44.41

3A version available: order code for "Additional approval", option LP in conjunction with
Ra_{max} = 30 µin: order code for "Measuring tube material", option SB

Tri-Clamp (1½), for pipe according to DIN 11866 series C with nominal diameter reduction 1.4404 (316L)

Order code for "Process connection", option FAS

DN [in]	reduction to DN [in]	Clamp [in]	A [in]	B [in]	L [in]
1½	1	1½ ¹⁾	1.98	1.37	- ²⁾

3A version available: order code for "Additional approval", option LP in conjunction with
Ra_{max} = 30 µin: order code for "Measuring tube material", option SB

- 1) The connection corresponds to the hygienic clamp dimensions as per ASME BPE.
- 2) Information on the installation length is available from your Endress+Hauser sales organization.

Couplings

Thread SMS 1145

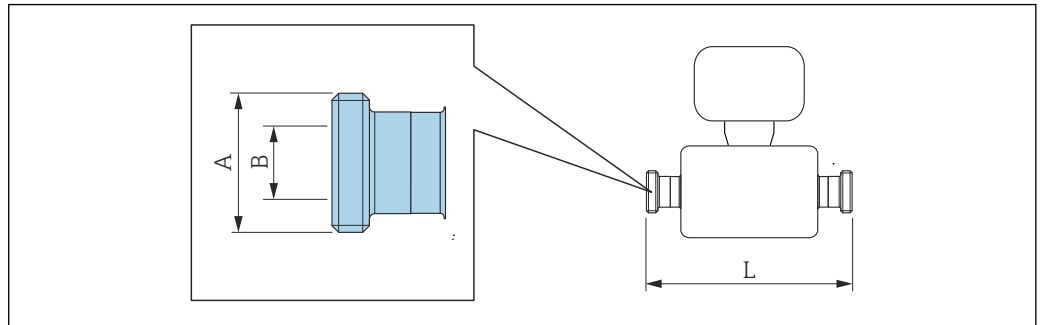

A0015628

i Length tolerance for dimension L in inch:
+0.06 / -0.08

Thread SMS 1145 1.4404 (316/316L) Order code for "Process connection", option SCS			
DN [in]	A [in]	B [in]	L [in]
1	Rd 40 × 1/6	0.904	17.36
2	Rd 70 × 1/6	1.944	28.80
3	Rd 98 × 1/6	2.916	36.00
4	Rd 132 × 1/6	3.904	45.12

3A version available: order code for "Additional approval", option LP in conjunction with Ra_{max} = 30 µin: order code for "Measuring tube material", option SB

Accessories

Rupture disk/purge connections

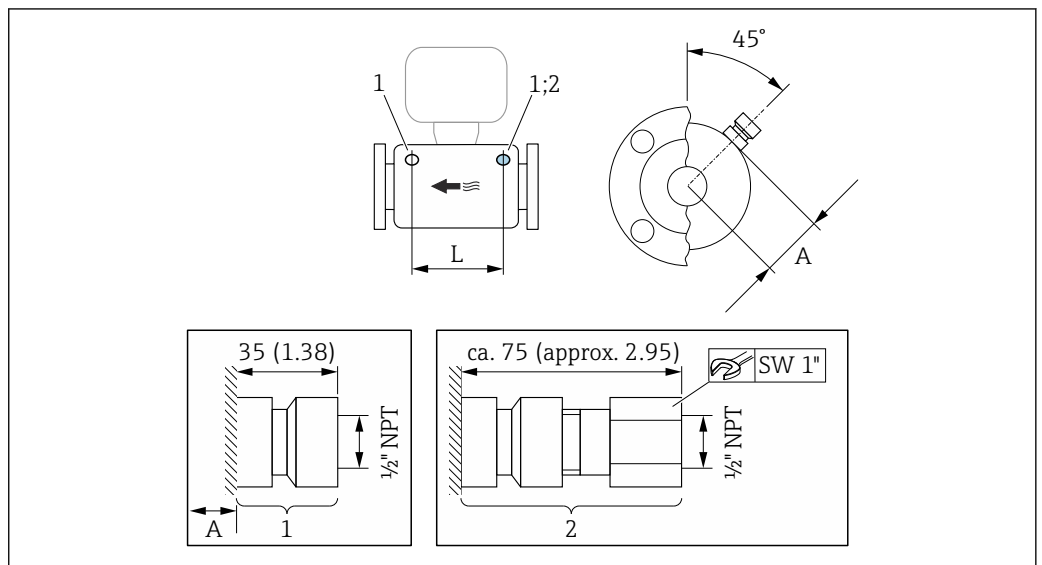

A0030349

39 Engineering unit mm (in)

- 1 Connection nipple for purge connections: order code for "Sensor options", option CH "Purge connection"
- 2 Connection nipple with rupture disk: order code for "Sensor option", option CA "Rupture disk"

DN	A	L
[in]	[in]	[in]
1	1.26	9.45
2	2.09	17.8
3	3.15	14.96
4	4.17	22.99

Protective cover

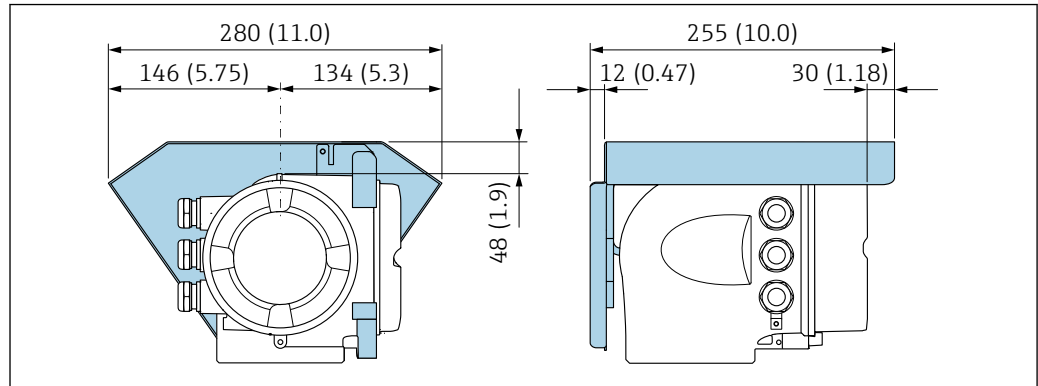

40 Engineering unit mm (in)

Remote display and operating module DKX001

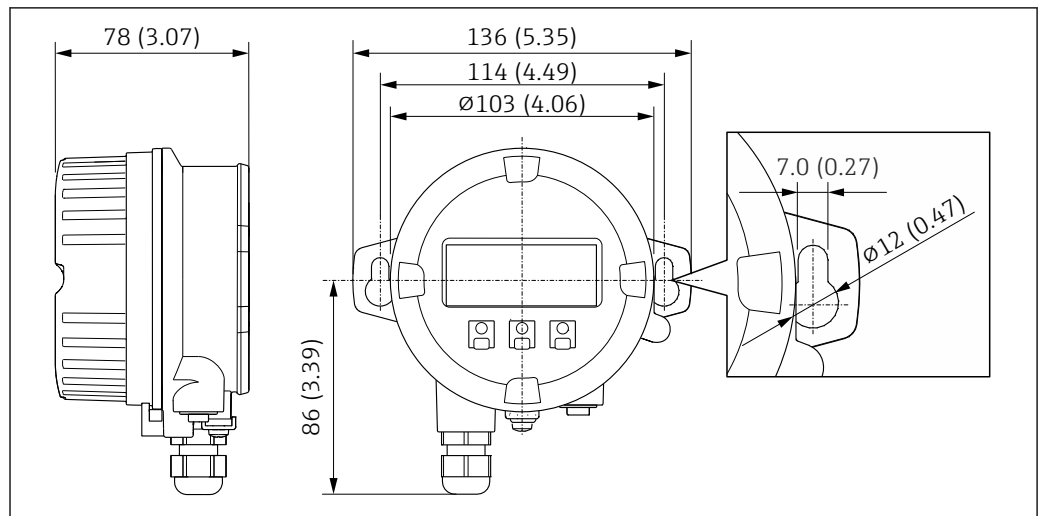

41 Engineering unit mm (in)

External WLAN antenna

i The external WLAN antenna is not suitable for use in hygienic applications.

External WLAN antenna mounted on device

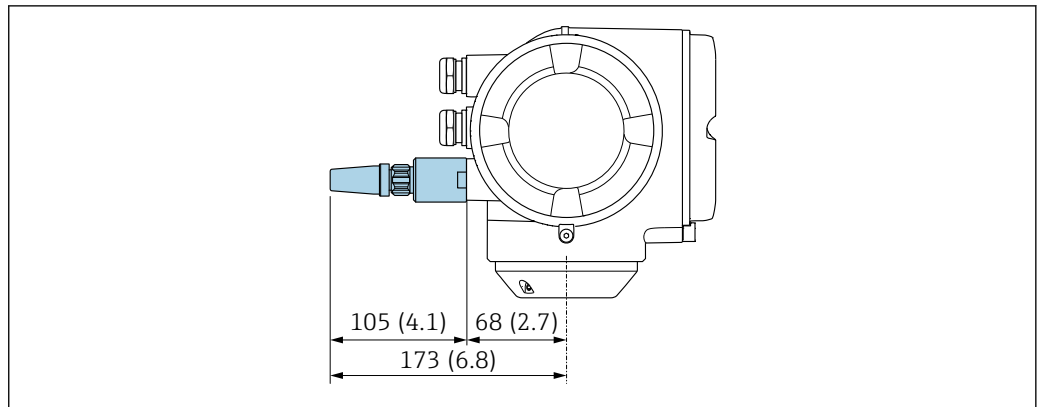

A0028923

42 Engineering unit mm (in)

External WLAN antenna mounted with cable

The external WLAN antenna can be mounted separately from the transmitter if the transmission/reception conditions at the transmitter mounting location are poor.

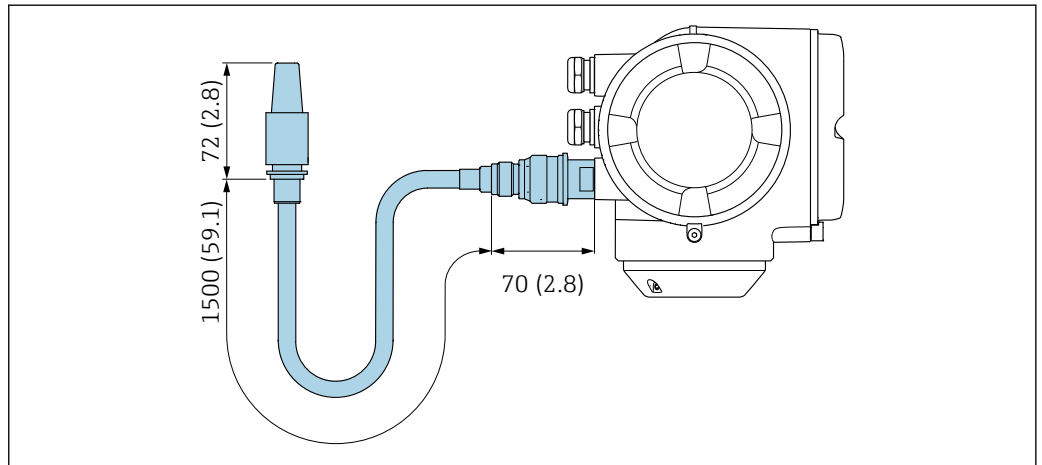

A0033597

43 Engineering unit mm (in)

Weight

All values (weight exclusive of packaging material) refer to devices with EN/DIN PN 40 flanges. Weight specifications including transmitter as per order code for "Housing", option A "Aluminum, coated".

Different values due to different transmitter versions:

- Transmitter version for the hazardous area
(Order code for "Housing", option A "Aluminum, coated"; Ex d): +2 kg (+4.4 lbs)
- Cast transmitter version, stainless
(Order code for "Housing", option L "Cast, stainless"): +6 kg (+13 lbs)
- Transmitter version for hygienic area
(Order code for "Housing", option B "Stainless, hygienic"): +0.2 kg (+0.44 lbs)

Weight in SI units

DN [mm]	Weight [kg]
25	11
50	33
80	60
100	149

Weight in US units

DN [in]	Weight [lbs]
1	24
2	73
3	132
4	329

Materials

Transmitter housing

Order code for "Housing":

- Option **A** "Aluminum, coated": aluminum, AlSi10Mg, coated
- Option **B** "Stainless, hygienic": stainless steel, 1.4404 (316L)
- Option **L** "Cast, stainless": cast, stainless steel, 1.4409 (CF3M) similar to 316L

Window material

Order code for "Housing":

- Option **A** "Aluminum, coated": glass
- Option **B** "Stainless, hygienic": polycarbonate
- Option **L** "Cast, stainless": glass

Seals

Order code for "Housing":

- Option **B** "Stainless, hygienic": EPDM and silicone

Cable entries/cable glands

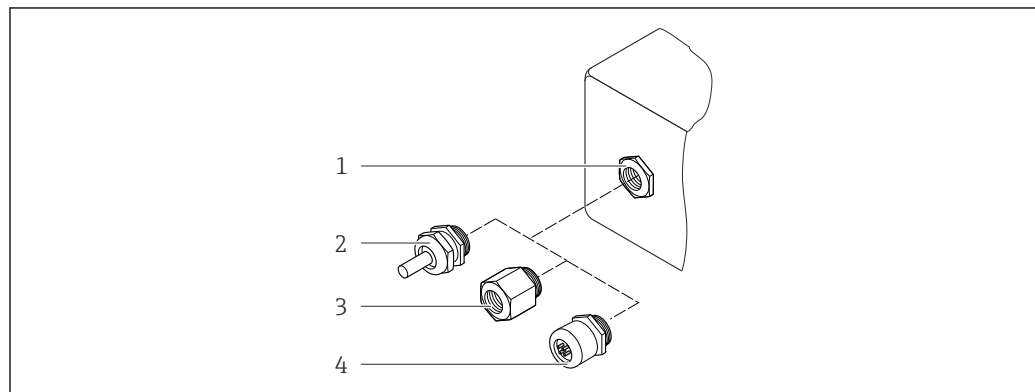

44 Possible cable entries/cable glands

- 1 Female thread M20 × 1.5
- 2 Cable gland M20 × 1.5
- 3 Adapter for cable entry with female thread G ½" or NPT ½"
- 4 Device plugs

Order code for "Housing", option A "Aluminum, coated"

The various cable entries are suitable for hazardous and non-hazardous areas.

Cable entry/cable gland	Material
Coupling M20 × 1.5	Non-Ex: plastic
	Z2, D2, Ex d/de: brass with plastic
Adapter for cable entry with female thread G ½"	Nickel-plated brass
Adapter for cable entry with female thread NPT ½"	

Order code for "Housing", option B "Stainless, hygienic"

The various cable entries are suitable for hazardous and non-hazardous areas.

Cable entry/cable gland	Material
Cable gland M20 × 1.5	Plastic
Adapter for cable entry with female thread G ½"	Nickel-plated brass
Adapter for cable entry with female thread NPT ½"	

Order code for "Housing", option L "Cast, stainless"

The various cable entries are suitable for hazardous and non-hazardous areas.

Cable entry/cable gland	Material
Cable gland M20 × 1.5	Stainless steel, 1.4404 (316L)
Adapter for cable entry with female thread G ½"	
Adapter for cable entry with female thread NPT ½"	

Device plug

Electrical connection	Material
Plug M12x1	<ul style="list-style-type: none"> ▪ Socket: Stainless steel, 1.4404 (316L) ▪ Contact housing: Polyamide ▪ Contacts: Gold-plated brass

Sensor housing



- Acid and alkali-resistant outer surface
- Stainless steel, 1.4404 (316L)

Measuring tubes

Stainless steel, 1.4404 (316/316L); manifold: stainless steel, 1.4404 (316/316L)

Process connections

Flanges according to EN 1092-1 (DIN 2501) / according to ASME B16.5 / as per JIS B2220: Stainless steel, 1.4404 (F316/F316L)

 Available process connections →  84

Seals

Welded process connections without internal seals

Accessories

Protective cover

Stainless steel, 1.4404 (316L)

External WLAN antenna

- Antenna: ASA plastic (acrylic ester-styrene-acrylonitrile) and nickel-plated brass
- Adapter: Stainless steel and nickel-plated brass
- Cable: Polyethylene
- Plug: Nickel-plated brass
- Angle bracket: Stainless steel

Process connections

Fixed flange connections:

- EN 1092-1 (DIN 2501) flange
- EN 1092-1 (DIN 2512N) flange
- ASME B16.5 flange
- JIS B2220 flange



Process connection materials → 83

Surface roughness

All data relate to parts in contact with fluid. The following surface roughness quality can be ordered.

- Not polished
- $Ra_{max} = 0.76 \mu\text{m}$ (30 μin)
- $Ra_{max} = 0.38 \mu\text{m}$ (15 μin)

Human interface

Operating concept

Operator-oriented menu structure for user-specific tasks

- Commissioning
- Operation
- Diagnostics
- Expert level

Fast and safe commissioning

- Guided menus ("Make-it-run" wizards) for applications
- Menu guidance with brief descriptions of the individual parameter functions
- Access to the device via Web server → ⓘ 105
- WLAN access to the device via mobile handheld terminal, tablet or smart phone

Reliable operation

- Operation in local language → ⓘ 85
- Uniform operating philosophy applied to device and operating tools
- If replacing electronic modules, transfer the device configuration via the integrated memory (HistoROM backup) which contains the process and measuring device data and the event logbook. No need to reconfigure.

Efficient diagnostics increase measurement availability

- Troubleshooting measures can be called up via the device and in the operating tools
- Diverse simulation options, logbook for events that occur and optional line recorder functions

Languages

Can be operated in the following languages:

- Via local operation
English, German, French, Spanish, Italian, Dutch, Portuguese, Polish, Russian, Turkish, Chinese, Japanese, Korean, Bahasa (Indonesian), Vietnamese, Czech, Swedish
- Via Web browser
English, German, French, Spanish, Italian, Dutch, Portuguese, Polish, Russian, Turkish, Chinese, Japanese, Korean, Bahasa (Indonesian), Vietnamese, Czech, Swedish
- Via "FieldCare", "DeviceCare" operating tool: English, German, French, Spanish, Italian, Chinese, Japanese

Local operation

Via display module

Equipment:

- Order code for "Display; operation", option F "4-line, illuminated, graphic display; touch control"
- Order code for "Display; operation", option G "4-line, illuminated, graphic display; touch control + WLAN"

ⓘ Information about WLAN interface → ⓘ 92

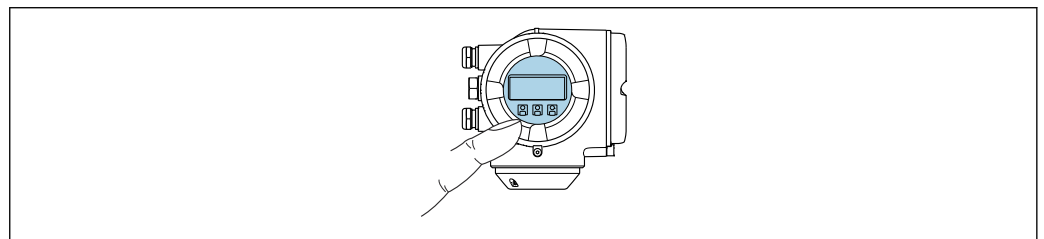

ⓘ 45 Operation with touch control

Display elements

- 4-line, illuminated, graphic display
- White background lighting; switches to red in event of device errors
- Format for displaying measured variables and status variables can be individually configured
- Permitted ambient temperature for the display: -20 to +60 °C (-4 to +140 °F)
The readability of the display may be impaired at temperatures outside the temperature range.

Operating elements

- External operation via touch control (3 optical keys) without opening the housing: ☒, ☑, ☒
- Operating elements also accessible in the various zones of the hazardous area

Via remote display and operating module DKX001

- i** The remote display and operating module DKX001 is available as an optional extra → ☒ 103.
- The remote display and operating module DKX001 is only available for the following housing versions, order code for "Housing":
 - Option A "Aluminum, coated"
 - Option L "Cast, stainless"
 - The measuring device is always supplied with a dummy cover when the remote display and operating module DKX001 is ordered directly with the measuring device. Display or operation at the transmitter is not possible in this case.
 - If ordered subsequently, the remote display and operating module DKX001 may not be connected at the same time as the existing measuring device display module. Only one display or operation unit may be connected to the transmitter at any one time.

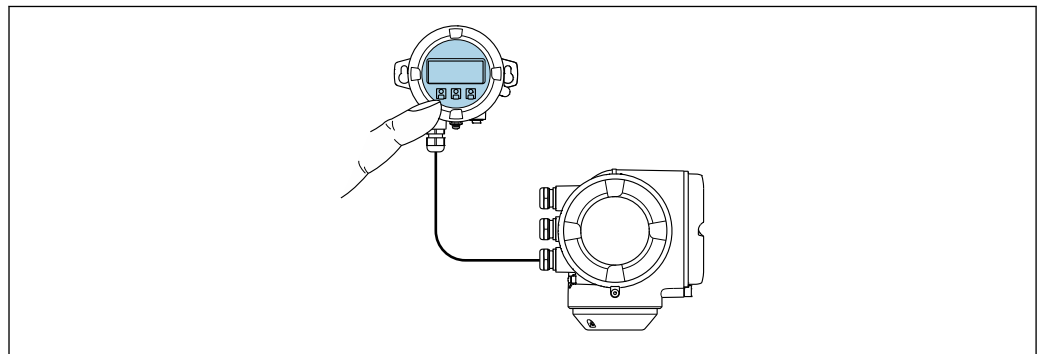

A0026786

☒ 46 Operation via remote display and operating module DKX001

Display and operating elements

The display and operating elements correspond to those of the display module → ☒ 85.

Housing material

The housing material of the display and operating module DKX001 depends on the choice of transmitter housing material.

Transmitter housing		Remote display and operating module
Order code for "Housing"	Material	Material
Option A "Aluminum, coated"	AlSi10Mg, coated	AlSi10Mg, coated
Option L "Cast, stainless"	Cast stainless steel, 1.4409 (CF3M) similar to 316L	1.4409 (CF3M)

Cable entry

Corresponds to the choice of transmitter housing, order code for "Electrical connection".

Connecting cable

→ ☒ 45

Dimensions

→ ☒ 73

Remote operation**Via HART protocol**

This communication interface is available in device versions with a HART output.

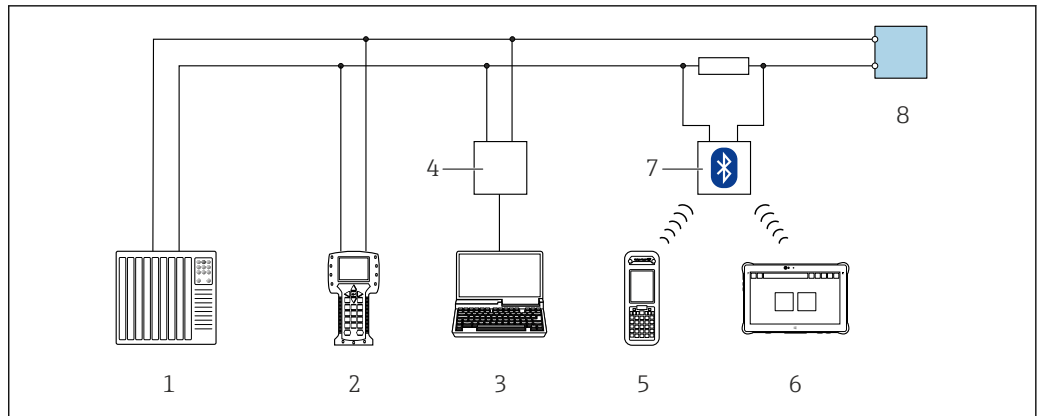

A0028747

47 Options for remote operation via HART protocol (active)

- 1 Control system (e.g. PLC)
- 2 Field Communicator 475
- 3 Computer with Web browser (e.g. Internet Explorer) for access to the integrated device Web server or computer with an operating tool (e.g. FieldCare, DeviceCare, AMS Device Manager, SIMATIC PDM) with COM DTM "CDI Communication TCP/IP"
- 4 Commubox FXA195 (USB)
- 5 Field Xpert SFX350 or SFX370
- 6 Field Xpert SMT70
- 7 VIATOR Bluetooth modem with connecting cable
- 8 Transmitter

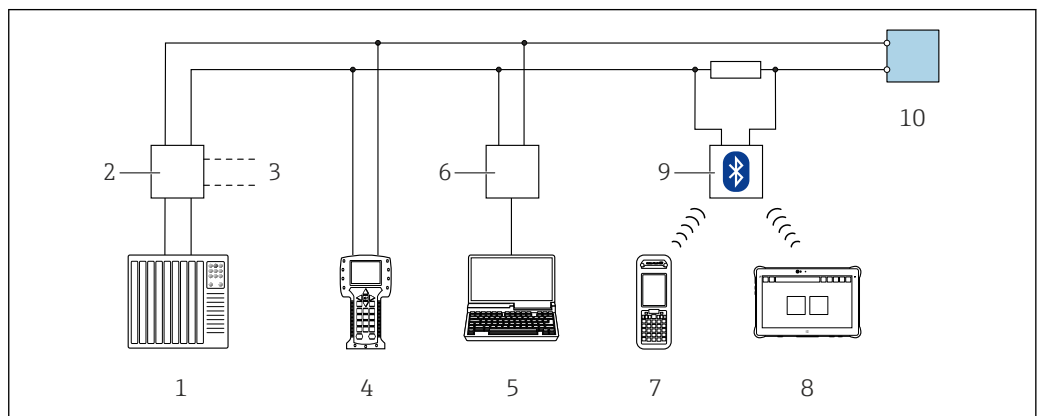

A0028746

48 Options for remote operation via HART protocol (passive)

- 1 Control system (e.g. PLC)
- 2 Transmitter power supply unit, e.g. RN221N (with communication resistor)
- 3 Connection for Commubox FXA195 and Field Communicator 475
- 4 Field Communicator 475
- 5 Computer with Web browser (e.g. Internet Explorer) for access to the integrated device Web server or computer with an operating tool (e.g. FieldCare, DeviceCare, AMS Device Manager, SIMATIC PDM) with COM DTM "CDI Communication TCP/IP"
- 6 Commubox FXA195 (USB)
- 7 Field Xpert SFX350 or SFX370
- 8 Field Xpert SMT70
- 9 VIATOR Bluetooth modem with connecting cable
- 10 Transmitter

Via FOUNDATION Fieldbus network

This communication interface is available in device versions with FOUNDATION Fieldbus.

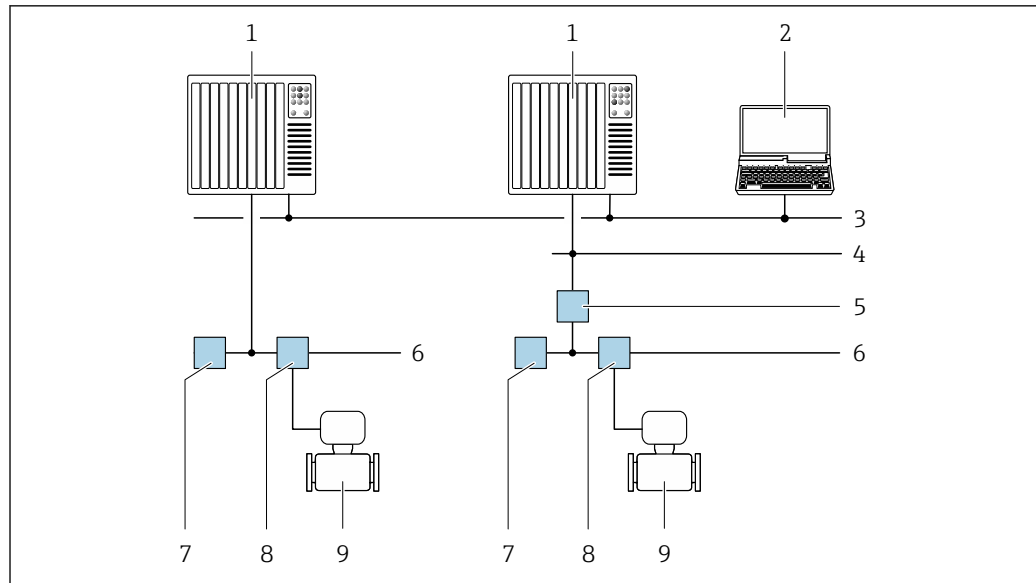

A0028837

49 Options for remote operation via FOUNDATION Fieldbus network

- 1 Automation system
- 2 Computer with FOUNDATION Fieldbus network card
- 3 Industry network
- 4 High Speed Ethernet FF-HSE network
- 5 Segment coupler FF-HSE/FF-H1
- 6 FOUNDATION Fieldbus FF-H1 network
- 7 Power supply FF-H1 network
- 8 T-box
- 9 Measuring device

Via PROFIBUS DP network

This communication interface is available in device versions with PROFIBUS DP.

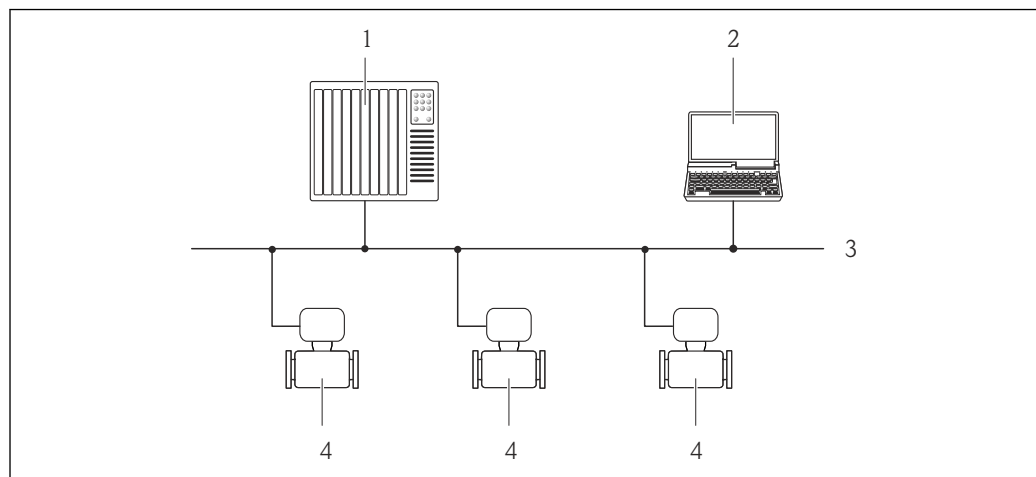

A0020903

50 Options for remote operation via PROFIBUS DP network

- 1 Automation system
- 2 Computer with PROFIBUS network card
- 3 PROFIBUS DP network
- 4 Measuring device

Via PROFIBUS PA network

This communication interface is available in device versions with PROFIBUS PA.

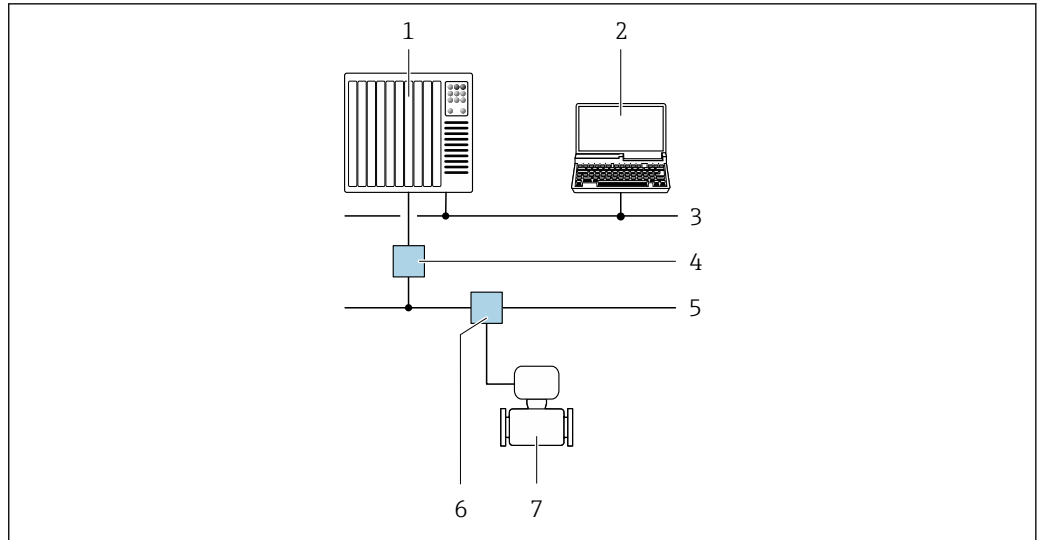

A0028838

51 Options for remote operation via PROFIBUS PA network

- 1 Automation system
- 2 Computer with PROFIBUS network card
- 3 PROFIBUS DP network
- 4 Segment coupler PROFIBUS DP/PA
- 5 PROFIBUS PA network
- 6 T-box
- 7 Measuring device

Via Modbus RS485 protocol

This communication interface is available in device versions with a Modbus-RS485 output.

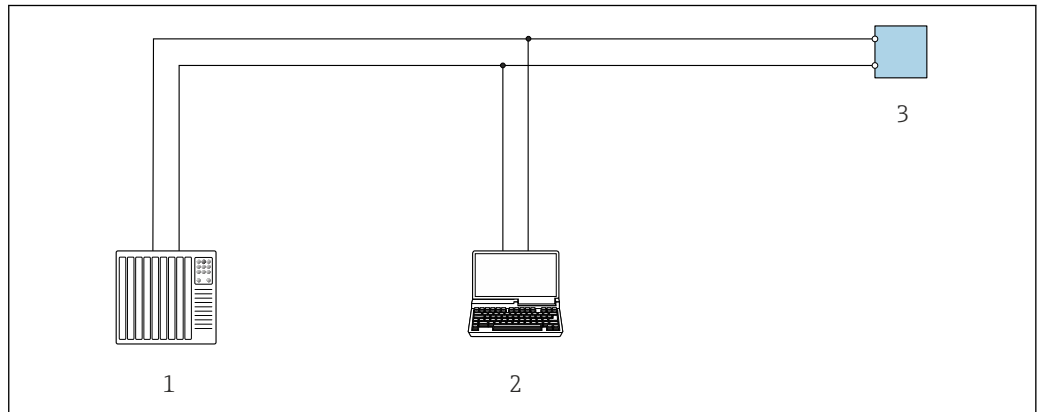

A0029437

52 Options for remote operation via Modbus-RS485 protocol (active)

- 1 Control system (e.g. PLC)
- 2 Computer with Web browser (e.g. Internet Explorer) for accessing the integrated device Web server or with operating tool (e.g. FieldCare, DeviceCare) with COM DTM "CDI Communication TCP/IP" or Modbus DTM
- 3 Transmitter

Via EtherNet/IP network

This communication interface is available in device versions with EtherNet/IP.

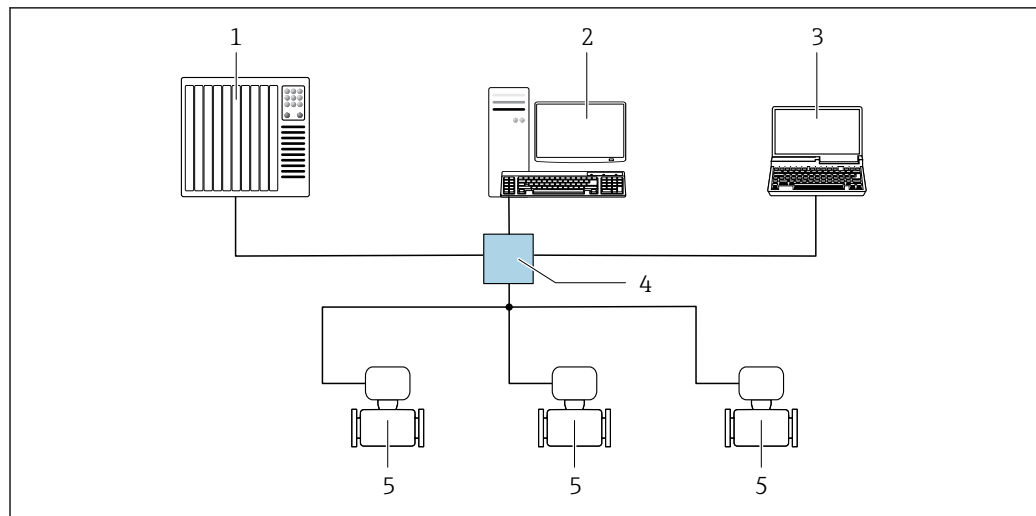
Star topology

A0032078

53 Options for remote operation via EtherNet/IP network: star topology

- 1 Automation system, e.g. "RSLogix" (Rockwell Automation)
- 2 Workstation for measuring device operation: with Custom Add-On Profile for "RSLogix 5000" (Rockwell Automation) or with Electronic Data Sheet (EDS)
- 3 Computer with Web browser (e.g. Internet Explorer) for accessing the integrated device Web server or computer with operating tool (e.g. FieldCare, DeviceCare) with COM DTM "CDI Communication TCP/IP"
- 4 Ethernet switch
- 5 Measuring device

Ring topology

The device is integrated via the terminal connection for signal transmission (output 1) and the service interface (CDI-RJ45).

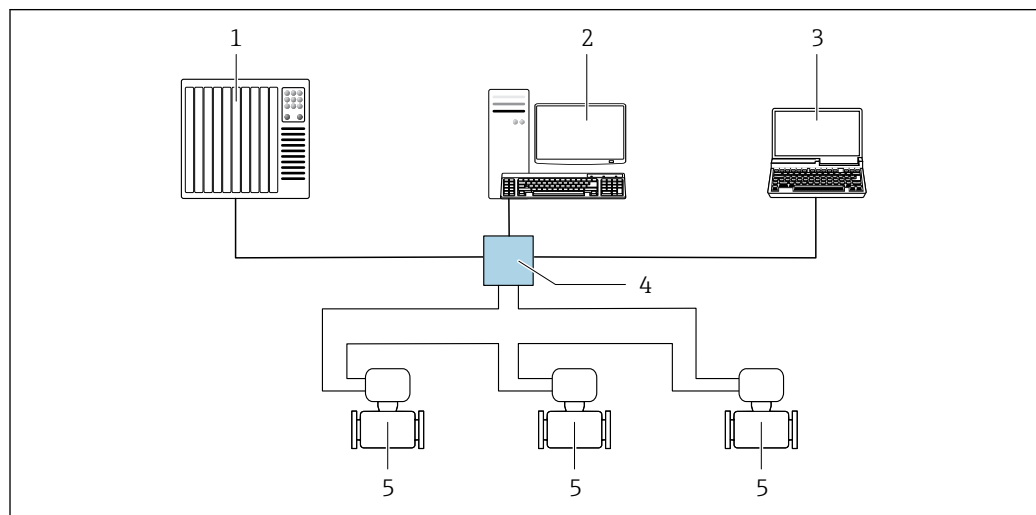

A0033725

54 Options for remote operation via EtherNet/IP network: ring topology

- 1 Automation system, e.g. "RSLogix" (Rockwell Automation)
- 2 Workstation for measuring device operation: with Custom Add-On Profile for "RSLogix 5000" (Rockwell Automation) or with Electronic Data Sheet (EDS)
- 3 Computer with Web browser (e.g. Internet Explorer) for accessing the integrated device Web server or computer with operating tool (e.g. FieldCare, DeviceCare) with COM DTM "CDI Communication TCP/IP"
- 4 Ethernet switch
- 5 Measuring device

Via PROFINET network

This communication interface is available in device versions with PROFINET.

Star topology

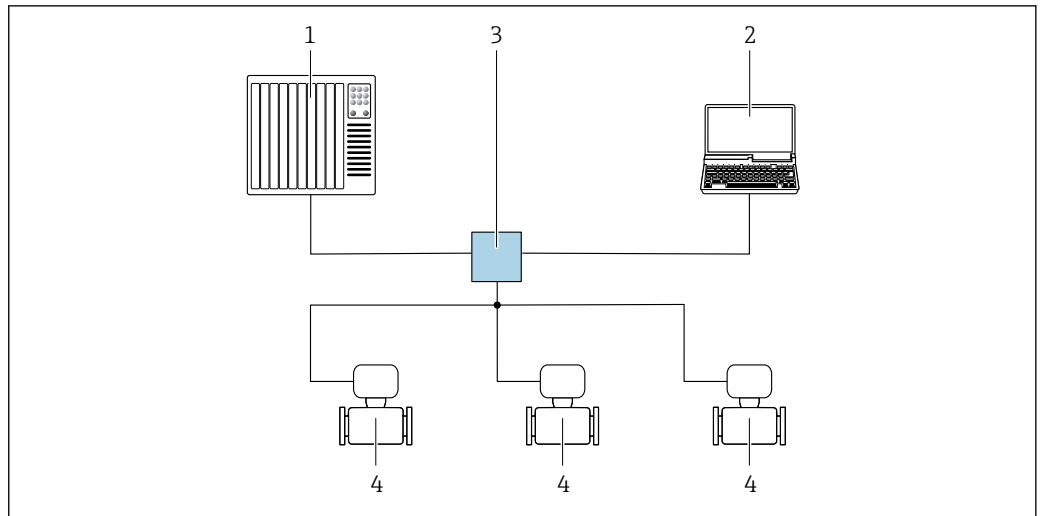

A0026545

55 Options for remote operation via PROFINET network: star topology

- 1 Automation system, e.g. Simatic S7 (Siemens)
- 2 Computer with Web browser (e.g. Internet Explorer) for accessing the integrated device Web server or computer with operating tool (e.g. FieldCare, DeviceCare, SIMATIC PDM) with COM DTM "CDI Communication TCP/IP"
- 3 Switch, e.g. Scalance X204 (Siemens)
- 4 Measuring device

Ring topology

The device is integrated via the terminal connection for signal transmission (output 1) and the service interface (CDI-RJ45).

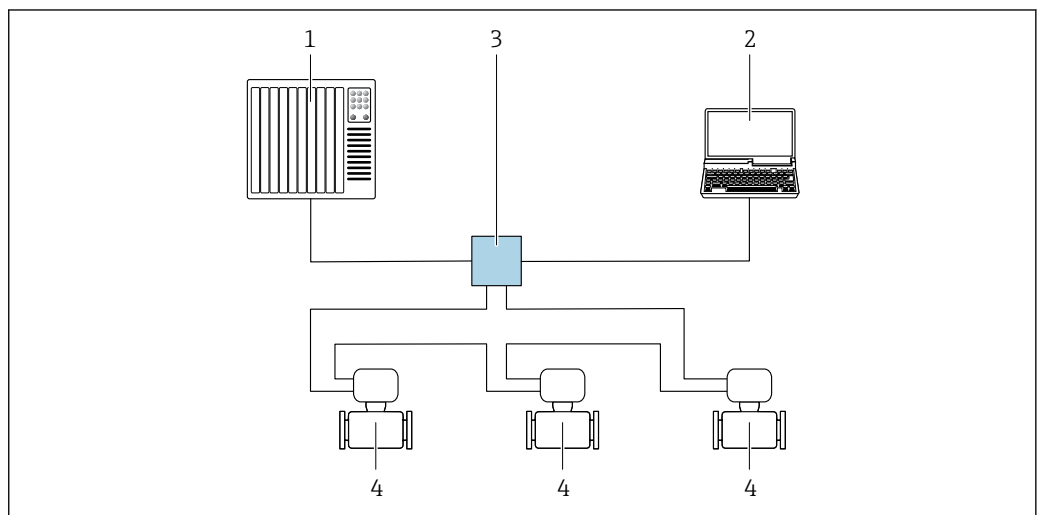

A0033719

56 Options for remote operation via PROFINET network: ring topology

- 1 Automation system, e.g. Simatic S7 (Siemens)
- 2 Computer with Web browser (e.g. Internet Explorer) for accessing the integrated device Web server or computer with operating tool (e.g. FieldCare, DeviceCare, SIMATIC PDM) with COM DTM "CDI Communication TCP/IP"
- 3 Switch, e.g. Scalance X204 (Siemens)
- 4 Measuring device

Service interface

Via service interface (CDI-RJ45)

A point-to-point connection can be established to configure the device onsite. With the housing open, the connection is established directly via the service interface (CDI-RJ45) of the device.

i An adapter for RJ45 and the M12 connector is optionally available:
Order code for "Accessories", option **NB**: "Adapter RJ45 M12 (service interface)"

The adapter connects the service interface (CDI-RJ45) to an M12 connector mounted in the cable entry. Therefore the connection to the service interface can be established via an M12 connector without opening the device.

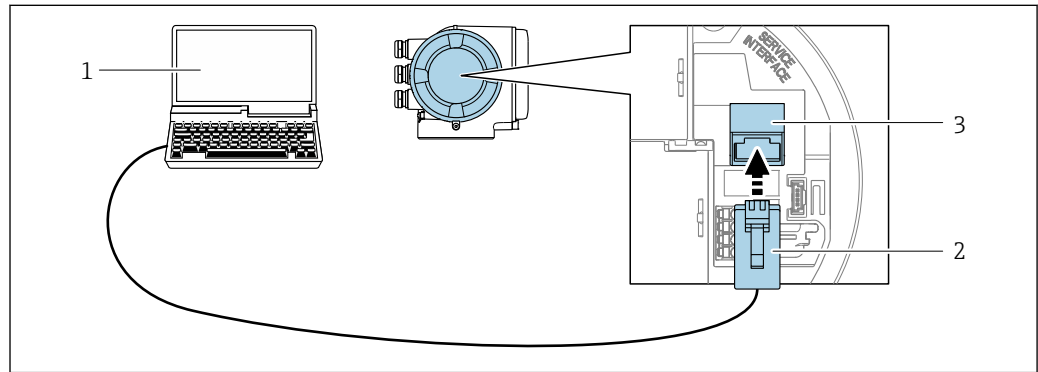

A0027563

57 Connection via service interface (CDI-RJ45)

- 1 Computer with Web browser (e.g. Microsoft Internet Explorer, Microsoft Edge) for accessing the integrated device Web server or with "FieldCare", "DeviceCare" operating tool with COM DTM "CDI Communication TCP/IP" or Modbus DTM
- 2 Standard Ethernet connecting cable with RJ45 connector
- 3 Service interface (CDI-RJ45) of the measuring device with access to the integrated Web server

Via WLAN interface

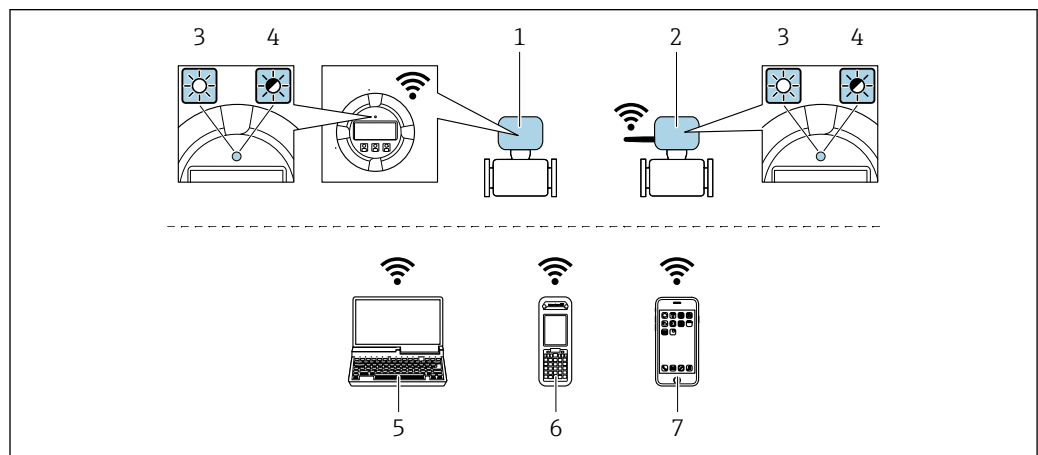

The optional WLAN interface is available on the following device version:

Order code for "Display; operation", option G "4-line, illuminated; touch control + WLAN"



A0034570

- 1 Transmitter with integrated WLAN antenna
- 2 Transmitter with external WLAN antenna
- 3 LED lit constantly: WLAN reception is enabled on measuring device
- 4 LED flashing: WLAN connection established between operating unit and measuring device
- 5 Computer with WLAN interface and Web browser (e.g. Microsoft Internet Explorer, Microsoft Edge) for accessing the integrated device Web server or with operating tool (e.g. FieldCare, DeviceCare)
- 6 Mobile handheld terminal with WLAN interface and Web browser (e.g. Microsoft Internet Explorer, Microsoft Edge) for accessing the integrated device Web server or operating tool (e.g. FieldCare, DeviceCare)
- 7 Smart phone or tablet (e.g. Field Xpert SMT70)

Function	WLAN: IEEE 802.11 b/g (2.4 GHz) <ul style="list-style-type: none"> ▪ Access point with DHCP server (default setting) ▪ Network
Encryption	WPA2-PSK AES-128 (in accordance with IEEE 802.11i)
Configurable WLAN channels	1 to 11
Degree of protection	IP67
Available antennas	<ul style="list-style-type: none"> ▪ Internal antenna ▪ External antenna (optional) In the event of poor transmission/reception conditions at the place of installation. Available as an accessory →  103. <p> Only one antenna active in each case!</p>
Range	<ul style="list-style-type: none"> ▪ Internal antenna: typically 10 m (32 ft) ▪ External antenna: typically 50 m (164 ft)
Materials (external antenna)	<ul style="list-style-type: none"> ▪ Antenna: ASA plastic (acrylic ester-styrene-acrylonitrile) and nickel-plated brass ▪ Adapter: Stainless steel and nickel-plated brass ▪ Cable: Polyethylene ▪ Connector: Nickel-plated brass ▪ Angle bracket: Stainless steel

Network integration

With the optional "OPC-UA Server" application package, the device can be integrated into an Ethernet network via the service interface (CDI-RJ45 and WLAN) and communicate with OPC-UA clients. If the device is used in this way, IT security must be considered.

 Transmitters with an Ex de approval may **not** be connected via the service interface (CDI-RJ45)!
Order code for "Approval transmitter + sensor", options (Ex de):
BA, BB, C1, C2, GA, GB, MA, MB, NA, NB

For permanent access to device data and for device configuration via the Web server, the device is incorporated directly in a network via the service interface (CDI-RJ45). In this way, the device can be accessed any time from the control station. The measured values are processed separately via the inputs and outputs through the automation system.

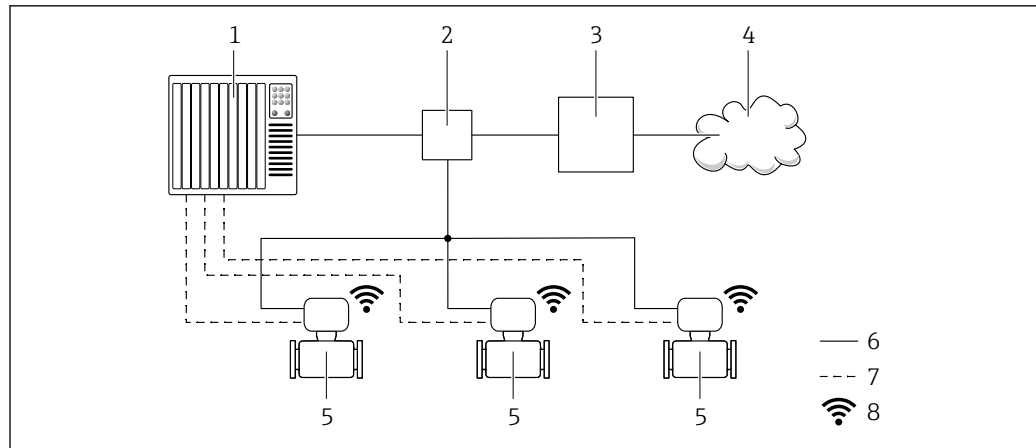

A0033618

- 1 Automation system, e.g. Simatic S7 (Siemens)
- 2 Ethernet switch
- 3 Edge Gateway
- 4 Cloud
- 5 Measuring device
- 6 Ethernet network
- 7 Measured values via inputs and outputs
- 8 Optional WLAN interface



The optional WLAN interface is available on the following device version:

Order code for "Display; operation", option **G** "4-line, illuminated, graphic display; touch control + WLAN"





Special Documentation for the OPC-UA Server application package → 107.

Supported operating tools

Different operating tools can be used for local or remote access to the measuring device. Depending on the operating tool used, access is possible with different operating units and via a variety of interfaces.

Supported operating tools	Operating unit	Interface	Additional information
Web browser	Notebook, PC or tablet with Web browser	<ul style="list-style-type: none"> ▪ CDI-RJ45 service interface ▪ WLAN interface ▪ Ethernet-based fieldbus (EtherNet/IP, PROFINET) 	Special Documentation for device → 107
DeviceCare SFE100	Notebook, PC or tablet with Microsoft Windows system	<ul style="list-style-type: none"> ▪ CDI-RJ45 service interface ▪ WLAN interface ▪ Fieldbus protocol 	→ 105

Supported operating tools	Operating unit	Interface	Additional information
FieldCare SFE500	Notebook, PC or tablet with Microsoft Windows system	<ul style="list-style-type: none"> ■ CDI-RJ45 service interface ■ WLAN interface ■ Fieldbus protocol 	→  105
Device Xpert	Field Xpert SFX 100/350/370	HART and FOUNDATION Fieldbus fieldbus protocol	Operating Instructions BA01202S Device description files: Use update function of handheld terminal

 Other operating tools based on FDT technology with a device driver such as DTM/iDTM or DD/EDD can be used for device operation. These operating tools are available from the individual manufacturers. Integration into the following operating tools, among others, is supported:

- FactoryTalk AssetCentre (FTAC) by Rockwell Automation → www.rockwellautomation.com
- Process Device Manager (PDM) by Siemens → www.siemens.com
- Asset Management Solutions (AMS) by Emerson → www.emersonprocess.com
- FieldCommunicator 375/475 by Emerson → www.emersonprocess.com
- Field Device Manager (FDM) by Honeywell → www.honeywellprocess.com
- FieldMate by Yokogawa → www.yokogawa.com
- PACTWare → www.pactware.com

The associated device description files are available at: www.endress.com → Downloads

Web server



Thanks to the integrated Web server, the device can be operated and configured via a Web browser and via a service interface (CDI-RJ45) or via a WLAN interface. The structure of the operating menu is the same as for the local display. In addition to the measured values, status information on the device is also displayed and allows the user to monitor the status of the device. Furthermore the device data can be managed and the network parameters can be configured.

A device that has a WLAN interface (can be ordered as an option) is required for the WLAN connection: order code for "Display; operation", option G "4-line, illuminated; touch control + WLAN". The device acts as an Access Point and enables communication by computer or a mobile handheld terminal.

Supported functions

Data exchange between the operating unit (such as a notebook for example) and the measuring device:

- Upload the configuration from the measuring device (XML format, configuration backup)
- Save the configuration to the measuring device (XML format, restore configuration)
- Export event list (.csv file)
- Export parameter settings (.csv file or PDF file, document the measuring point configuration)
- Export the Heartbeat verification log (PDF file, only available with the "Heartbeat Verification" application package)
- Flash firmware version for device firmware upgrade, for instance
- Download driver for system integration
- Visualize up to 1000 saved measured values (only available with the **Extended HistoROM** application package →  102)

 Web server special documentation →  107

HistoROM data management

The measuring device features HistoROM data management. HistoROM data management comprises both the storage and import/export of key device and process data, making operation and servicing far more reliable, secure and efficient.

 When the device is delivered, the factory settings of the configuration data are stored as a backup in the device memory. This memory can be overwritten with an updated data record, for example after commissioning.

Additional information on the data storage concept

There are different types of data storage units in which device data are stored and used by the device:

	Device memory	T-DAT	S-DAT
Available data	<ul style="list-style-type: none"> ▪ Event logbook such as diagnostic events for example ▪ Parameter data record backup ▪ Device firmware package ▪ Driver for system integration for exporting via Web server, e.g.: <ul style="list-style-type: none"> ▪ GSD for PROFIBUS DP ▪ GSD for PROFIBUS PA ▪ GSDML for PROFINET ▪ EDS for EtherNet/IP ▪ DD for FOUNDATION Fieldbus 	<ul style="list-style-type: none"> ▪ Measured value logging ("Extended HistoROM" order option) ▪ Current parameter data record (used by firmware at run time) ▪ Peakhold indicator (min/max values) ▪ Totalizer values 	<ul style="list-style-type: none"> ▪ Sensor data: nominal diameter etc. ▪ Serial number ▪ Calibration data ▪ Device configuration (e.g. SW options, fixed I/O or multi I/O)
Storage location	Fixed on the user interface board in the connection compartment	Attachable to the user interface board in the connection compartment	In the sensor plug in the transmitter neck part

Data backup

Automatic

- The most important device data (sensor and transmitter) are automatically saved in the DAT modules
- If the transmitter or measuring device is replaced: once the T-DAT containing the previous device data has been exchanged, the new measuring device is ready for operation again immediately without any errors
- If the sensor is replaced: once the sensor has been replaced, new sensor data are transferred from the S-DAT in the measuring device and the measuring device is ready for operation again immediately without any errors
- If exchanging the electronics module (e.g. I/O electronics module): Once the electronics module has been replaced, the software of the module is compared against the current device firmware. The module software is upgraded or downgraded where necessary. The electronics module is available for use immediately afterwards and no compatibility problems occur.

Manual

Additional parameter data record (complete parameter settings) in the integrated device memory HistoROM backup for:

- Data backup function
Backup and subsequent restoration of a device configuration in the device memory HistoROM backup
- Data comparison function
Comparison of the current device configuration with the device configuration saved in the device memory HistoROM backup

Data transfer

Manual

- Transfer of a device configuration to another device using the export function of the specific operating tool, e.g. with FieldCare, DeviceCare or Web server: to duplicate the configuration or to store in an archive (e.g. for backup purposes)
- Transmission of the drivers for system integration via Web server, e.g.:
 - GSD for PROFIBUS DP
 - GSD for PROFIBUS PA
 - GSDML for PROFINET
 - EDS for EtherNet/IP
 - DD for FOUNDATION Fieldbus

Event list

Automatic

- Chronological display of up to 20 event messages in the events list
- If the **Extended HistoROM** application package (order option) is enabled: up to 100 event messages are displayed in the events list along with a time stamp, plain text description and remedial measures
- The events list can be exported and displayed via a variety of interfaces and operating tools e.g. DeviceCare, FieldCare or Web server

Data logging

Manual

If the **Extended HistoROM** application package (order option) is enabled:

- Record up to 1 000 measured values via 1 to 4 channels
- User configurable recording interval
- Record up to 250 measured values via each of the 4 memory channels
- Export the measured value log via a variety of interfaces and operating tools e.g. FieldCare, DeviceCare or web server

Certificates and approvals

 Currently available certificates and approvals can be called up via the product configurator.

CE mark

The device meets the legal requirements of the applicable EU Directives. These are listed in the corresponding EU Declaration of Conformity along with the standards applied.

Endress+Hauser confirms successful testing of the device by affixing to it the CE mark.

RCM-tick symbol

The measuring system meets the EMC requirements of the "Australian Communications and Media Authority (ACMA)".

Ex approval

The measuring device is certified for use in hazardous areas and the relevant safety instructions are provided in the separate "Safety Instructions" (XA) document. Reference is made to this document on the nameplate.

Devices with the order code for "Approval; transmitter + sensor", option BA, BB, BC or BD have equipment protection level (EPL) Ga/Gb (Zone 0 in the measuring tube).

 The separate Ex documentation (XA) containing all the relevant explosion protection data is available from your Endress+Hauser sales center.

ATEX/IECEx

Currently, the following versions for use in hazardous areas are available:

Ex db eb

Category	Type of protection
II1/2G	Ex db eb ia IIC T6...T1 Ga/Gb Ex db eb ia IIB T6...T1 Ga/Gb
II2G	Ex db eb ia IIC T6...T1 Gb Ex db eb ia IIB T6...T1 Gb

Ex db

Category	Type of protection
II1/2G	Ex db ia IIC T6...T1 Ga/Gb Ex db ia IIB T6...T1 Ga/Gb
II2G	Ex db ia IIC T6...T1 Gb Ex db ia IIB T6...T1 Gb

Ex ec

Category	Type of protection
II3G	Ex ec IIC T5...T1 Gc

Ex tb

Category	Type of protection
II2D	Ex tb IIIC T** °C Db

cCSA_{US}

Currently, the following versions for use in hazardous areas are available:

IS (Ex i) and XP (Ex d)

- Class I, III, III Division 1 Groups A-G
- Class I, III, III Division 1 Groups C-G

NI (Ex nA)

Class I Division 2 Groups A - D

Ex de

- Class I, Zone 1 AEx/ Ex de ia IIC T6...T1 Ga/Gb
Class I, Zone 1 AEx/ Ex de ia IIB T6...T1 Ga/Gb
- Class I, Zone 1 AEx/ Ex de ia IIC T6...T1 Gb
Class I, Zone 1 AEx/ Ex de ia IIB T6...T1 Gb

Ex d

- Class I, Zone 1 AEx/ Ex d ia IIC T6...T1 Ga/Gb
Class I, Zone 1 AEx/ Ex d ia IIB T6...T1 Ga/Gb
- Class I, Zone 1 AEx/ Ex d ia IIC T6...T1 Gb
Class I, Zone 1 AEx/ Ex d ia IIB T6...T1 Gb

Ex nA

Class I, Zone 2 AEx/ Ex nA IIC T5...T1 Gc

Ex tb

Zone 21 AEx/ Ex tb IIIC T** °C Db

Sanitary compatibility

- 3-A approval
 - Only measuring devices with the order code for "Additional approval", option LP "3A" have 3-A approval.
 - The 3-A approval refers to the measuring device.
 - When installing the measuring device, ensure that no liquid can accumulate on the outside of the measuring device.
Remote transmitters must be installed in accordance with the 3-A Standard.
 - Accessories (e.g. heating jacket, weather protection cover, wall holder unit) must be installed in accordance with the 3-A Standard.
Each accessory can be cleaned. Disassembly may be necessary under certain circumstances.
- EHEDG-tested
Only devices with the order code for "Additional approval", option LT "EHEDG" have been tested and meet the requirements of the EHEDG.
To meet the requirements for EHEDG certification, the device must be used with process connections in accordance with the EHEDG position paper entitled "Easy Cleanable Pipe Couplings and Process Connections" (www.ehedg.org).
- FDA
- Food Contact Materials Regulation (EC) 1935/2004

Pharmaceutical compatibility

- FDA 21 CFR 177
 - USP <87>
 - USP <88> Class VI 121 °C
 - TSE/BSE Certificate of Suitability
 - cGMP
-  Devices with order code for "Test, certificate", option JG "Compliance with requirements derived from cGMP, declaration" are in accordance with cGMP requirements relating to the surfaces of wetted parts, design, FDA 21 CFR material conformity, USP Class VI tests and TSE/BSE-compliance.
- A manufacturer's declaration specific to the serial number is supplied with the device.



Functional safety

The measuring device can be used for flow monitoring systems (min., max., range) up to SIL 2 (single-channel architecture; order code for "Additional approval", option LA) and SIL 3

(multichannel architecture with homogeneous redundancy) and is independently evaluated and certified by the TÜV in accordance with IEC 61508.

The following types of monitoring in safety equipment are possible:

- Mass flow
- Volume flow
- Density

 Functional Safety Manual with information on the SIL device →  106

HART certification

HART interface

The measuring device is certified and registered by the FieldComm Group. The measuring system meets all the requirements of the following specifications:

- Certified according to HART 7
- The device can also be operated with certified devices of other manufacturers (interoperability)

FOUNDATION Fieldbus certification

FOUNDATION Fieldbus interface

The measuring device is certified and registered by the FieldComm Group. The measuring system meets all the requirements of the following specifications:

- Certified in accordance with FOUNDATION Fieldbus H1
- Interoperability Test Kit (ITK), revision version 6.2.0 (certificate available on request)
- Physical Layer Conformance Test
- The device can also be operated with certified devices of other manufacturers (interoperability)

Certification PROFIBUS

PROFIBUS interface

The measuring device is certified and registered by the PNO (PROFIBUS User Organization). The measuring system meets all the requirements of the following specifications:

- Certified in accordance with PROFIBUS PA Profile 3.02
- The device can also be operated with certified devices of other manufacturers (interoperability)

EtherNet/IP certification

The measuring device is certified and registered by the ODVA (Open Device Vendor Association). The measuring system meets all the requirements of the following specifications:

- Certified in accordance with the ODVA Conformance Test
- EtherNet/IP Performance Test
- EtherNet/IP PlugFest compliance
- The device can also be operated with certified devices of other manufacturers (interoperability)

Certification PROFINET

PROFINET interface

The measuring device is certified and registered by the PNO (PROFIBUS User Organization). The measuring system meets all the requirements of the following specifications:

- Certified according to:
 - Test specification for PROFINET devices
 - PROFINET Security Level 2 – Netload Class
- The device can also be operated with certified devices of other manufacturers (interoperability)
- The device supports PROFINET S2 system redundancy.

Pressure Equipment Directive

The devices can be ordered with or without a PED approval. If a device with a PED approval is required, this must be explicitly stated in the order. For devices with nominal diameters less than or equal to DN 25 (1"), this is neither possible nor necessary.

- With the identification PED/G1/x (x = category) on the sensor nameplate, Endress+Hauser confirms conformity with the "Essential Safety Requirements" specified in Appendix I of the Pressure Equipment Directive 2014/68/EU.
- Devices bearing this marking (PED) are suitable for the following types of medium:
 - Media in Group 1 and 2 with a vapor pressure greater than, or smaller and equal to 0.5 bar (7.3 psi)
 - Unstable gases
- Devices not bearing this marking (PED) are designed and manufactured according to good engineering practice. They meet the requirements of Article 4 paragraph 3 of the Pressure Equipment Directive 2014/68/EU. The range of application is indicated in tables 6 to 9 in Annex II of the Pressure Equipment Directive 2014/68/EU.

Radio approval

The measuring device has radio approval.



For detailed information regarding radio approval, see Special Documentation → 107

Measuring instrument approval

The measuring device is approved as a component in measuring systems (MI-005) in service subject to legal metrological control in accordance with the European Measuring Instruments Directive 2004/22/EC (MID).

The measuring device is qualified to OIML R117 and has an OIML Certificate of Conformity (optional).

Additional certification**CRN approval**

Some device versions have CRN approval. A CRN-approved process connection with a CSA approval must be ordered for a CRN-approved device.

Tests and certificates

- EN10204-3.1 material certificate, parts and sensor housing in contact with medium
- Pressure testing, internal procedure, inspection certificate
- PMI test (XRF), internal procedure, wetted parts, test report
- Compliance with requirements derived from cGMP, Declaration
- EN10204-2.1 confirmation of compliance with the order and EN10204-2.2 test report

Testing of welded connections

Option	Test standard				Component	
	ISO 23277 AL2x (PT) ISO 10675-1 AL1 (RT, DR)	ASME B31.3 NFS	ASME VIII Div.1 Appx. 4+8	NORSOK M-601	Measuring tube	Process connection
CF	x				PT	RT
KK		x			PT	RT
KP			x		PT	RT
KR				x	VT, PT	VT, RT
K1	x				PT	DR
K2		x			PT	DR
K3			x		PT	DR
K4				x	VT, PT	VT, DR
PT = penetrant testing, RT = radiographic testing, VT = visual testing, DR = digital radiography All options with test report						

Other standards and guidelines

- EN 60529
Degrees of protection provided by enclosures (IP code)
- IEC/EN 60068-2-6
Environmental influences: Test procedure - Test Fc: vibrate (sinusoidal).
- IEC/EN 60068-2-31
Environmental influences: Test procedure - Test Ec: shocks due to rough handling, primarily for devices.
- EN 61010-1
Safety requirements for electrical equipment for measurement, control and laboratory use - general requirements
- IEC/EN 61326
Emission in accordance with Class A requirements. Electromagnetic compatibility (EMC requirements).
- NAMUR NE 21
Electromagnetic compatibility (EMC) of industrial process and laboratory control equipment
- NAMUR NE 32
Data retention in the event of a power failure in field and control instruments with microprocessors

- NAMUR NE 43
Standardization of the signal level for the breakdown information of digital transmitters with analog output signal.
- NAMUR NE 53
Software of field devices and signal-processing devices with digital electronics
- NAMUR NE 80
The application of the pressure equipment directive to process control devices
- NAMUR NE 105
Specifications for integrating fieldbus devices in engineering tools for field devices
- NAMUR NE 107
Self-monitoring and diagnosis of field devices
- NAMUR NE 131
Requirements for field devices for standard applications
- NAMUR NE 132
Coriolis mass meter
- ETSI EN 300 328
Guidelines for 2.4 GHz radio components.
- EN 301489
Electromagnetic compatibility and radio spectrum matters (ERM).

Ordering information

Detailed ordering information is available for your nearest sales organization www.addresses.endress.com or in the Product Configurator under www.endress.com :

1. Click Corporate
2. Select the country
3. Click Products
4. Select the product using the filters and search field
5. Open the product page

The Configuration button to the right of the product image opens the Product Configurator.



Product Configurator - the tool for individual product configuration

- Up-to-the-minute configuration data
- Depending on the device: Direct input of measuring point-specific information such as measuring range or operating language
- Automatic verification of exclusion criteria
- Automatic creation of the order code and its breakdown in PDF or Excel output format
- Ability to order directly in the Endress+Hauser Online Shop

Application packages

Many different application packages are available to enhance the functionality of the device. Such packages might be needed to address safety aspects or specific application requirements.

The application packages can be ordered with the device or subsequently from Endress+Hauser. Detailed information on the order code in question is available from your local Endress+Hauser sales center or on the product page of the Endress+Hauser website: www.endress.com.



Detailed information on the application packages:
Special Documentation for the device → 106

Diagnostics functions

Package	Description
Extended HistoROM	<p>Comprises extended functions concerning the event log and the activation of the measured value memory.</p> <p>Event log: Memory volume is extended from 20 message entries (standard version) to up to 100 entries.</p> <p>Data logging (line recorder):</p> <ul style="list-style-type: none"> ▪ Memory capacity for up to 1000 measured values is activated. ▪ 250 measured values can be output via each of the 4 memory channels. The recording interval can be defined and configured by the user. ▪ Measured value logs can be accessed via the local display or operating tool e.g. FieldCare, DeviceCare or Web server.

Heartbeat Technology

Package	Description
Heartbeat Verification +Monitoring	<p>Heartbeat Verification Meets the requirement for traceable verification to DIN ISO 9001:2008 Chapter 7.6 a) "Control of monitoring and measuring equipment".</p> <ul style="list-style-type: none"> ▪ Functional testing in the installed state without interrupting the process. ▪ Traceable verification results on request, including a report. ▪ Simple testing process via local operation or other operating interfaces. ▪ Clear measuring point assessment (pass/fail) with high test coverage within the framework of manufacturer specifications. ▪ Extension of calibration intervals according to operator's risk assessment. <p>Heartbeat Monitoring Continuously supplies data, which are characteristic of the measuring principle, to an external condition monitoring system for the purpose of preventive maintenance or process analysis. These data enable the operator to:</p> <ul style="list-style-type: none"> ▪ Draw conclusions - using these data and other information - about the impact process influences (such as corrosion, abrasion, buildup etc.) have on the measuring performance over time. ▪ Schedule servicing in time. ▪ Monitor the process or product quality, e.g. gas pockets.



Concentration

Package	Description
Concentration	<p>Calculation and outputting of fluid concentrations</p> <p>The measured density is converted to the concentration of a substance of a binary mixture using the "Concentration" application package:</p> <ul style="list-style-type: none"> ▪ Choice of predefined fluids (e.g. various sugar solutions, acids, alkalis, salts, ethanol etc.) ▪ Common or user-defined units ("Brix", "Plato", % mass, % volume, mol/l etc.) for standard applications. ▪ Concentration calculation from user-defined tables.

Petroleum

Package	Description
Petroleum	<p>The most important parameters for the Oil & Gas Industry can be calculated and displayed with this application package.</p> <ul style="list-style-type: none"> ▪ Corrected volume flow and calculated reference density in accordance with the "API Manual of Petroleum Measurement Standards, Chapter 11.1" ▪ Water content, based on density measurement ▪ Weighted mean of the density and temperature

OPC-UA server











Package	Description
OPC-UA-Server	<p>The application package provides the user with an integrated OPC-UA server for comprehensive instrument services for IoT and SCADA applications.</p> <p> Special Documentation for the "OPC-UA-Server" application package →  107.</p>

Accessories



Various accessories, which can be ordered with the device or subsequently from Endress+Hauser, are available for the device. Detailed information on the order code in question is available from your local Endress+Hauser sales center or on the product page of the Endress+Hauser website: www.endress.com.

Device-specific accessories





For the transmitter

Accessories	Description
Proline 300 transmitter	<p>Transmitter for replacement or storage. Use the order code to define the following specifications:</p> <ul style="list-style-type: none"> ▪ Approvals ▪ Output ▪ Input ▪ Display/operation ▪ Housing ▪ Software <p> Order code: 8X3BXX</p> <p> Installation Instructions EA01200D</p>
Remote display and operating module DKX001	<ul style="list-style-type: none"> ▪ If ordered directly with the measuring device: Order code for "Display; operation", option O "Remote display 4-line illum.; 10 m (30 ft) Cable; touch control" ▪ If ordered separately: <ul style="list-style-type: none"> ▪ Measuring device: order code for "Display; operation", option M "W/o, prepared for remote display" ▪ DKX001: Via the separate product structure DKX001 ▪ If ordered subsequently: DKX001: Via the separate product structure DKX001 <p>Mounting bracket for DKX001</p> <ul style="list-style-type: none"> ▪ If ordered directly: order code for "Accessory enclosed", option RA "Mounting bracket, pipe 1/2" ▪ If ordered subsequently: order number: 71340960 <p>Connecting cable (replacement cable) Via the separate product structure: DKX002</p> <p> Further information on display and operating module DKX001 →  86.</p> <p> Special Documentation SD01763D</p>
External WLAN antenna	<p>External WLAN antenna with 1.5 m (59.1 in) connecting cable and two angle brackets. Order code for "Accessory enclosed", option P8 "Wireless antenna wide area".</p> <p> <ul style="list-style-type: none"> ▪ The external WLAN antenna is not suitable for use in hygienic applications. ▪ Further information on the WLAN interface →  92. </p> <p> Order number: 71351317</p> <p> Installation Instructions EA01238D</p>
Protective cover	<p>Is used to protect the measuring device from the effects of the weather: e.g. rainwater, excess heating from direct sunlight.</p> <p> Order number: 71343505</p> <p> Installation Instructions EA01160D</p>



For the sensor

Accessories	Description
Heating jacket	<p>Is used to stabilize the temperature of the fluids in the sensor. Water, water vapor and other non-corrosive liquids are permitted for use as fluids.</p> <p> If using oil as a heating medium, please consult with Endress+Hauser.</p> <ul style="list-style-type: none"> ▪ If ordered together with the measuring device: order code for "Enclosed accessories" <ul style="list-style-type: none"> ▪ Option RB "heating jacket, G 1/2" internal thread" ▪ Option RC "heating jacket, G 3/4" internal thread" ▪ Option RD "Heating jacket, NPT 1/2" internal thread" ▪ Option RE "Heating jacket, NPT 3/4" internal thread" ▪ If ordered subsequently: Use the order code with the product root DK8003. <p> Special Documentation SD02161D</p>





Communication-specific accessories

Accessories	Description
Commubox FXA195 HART	<p>For intrinsically safe HART communication with FieldCare via the USB interface.</p> <p> Technical Information TI00404F</p>
HART Loop Converter HMX50	<p>Is used to evaluate and convert dynamic HART process variables to analog current signals or limit values.</p> <p> <ul style="list-style-type: none"> ▪ Technical Information TI00429F ▪ Operating Instructions BA00371F </p>
Fieldgate FXA42	<p>Is used to transmit the measured values of connected 4 to 20 mA analog measuring devices, as well as digital measuring devices</p> <p> <ul style="list-style-type: none"> ▪ Technical Information TI01297S ▪ Operating Instructions BA01778S ▪ Product page: www.endress.com/fxa42 </p>
Field Xpert SMT70	<p>The Field Xpert SMT70 tablet PC for device configuration enables mobile plant asset management in hazardous and non-hazardous areas. It is suitable for commissioning and maintenance staff to manage field instruments with a digital communication interface and to record progress.</p> <p>This tablet PC is designed as an all-in-one solution with a preinstalled driver library and is an easy-to-use, touch-sensitive tool which can be used to manage field instruments throughout their entire life cycle.</p> <p> <ul style="list-style-type: none"> ▪ Technical Information TI01342S ▪ Operating Instructions BA01709S ▪ Product page: www.endress.com/smt70 </p>
Field Xpert SMT77	<p>The Field Xpert SMT77 tablet PC for device configuration enables mobile plant asset management in areas categorized as Ex Zone 1.</p> <p> <ul style="list-style-type: none"> ▪ Technical Information TI01418S ▪ Operating Instructions BA01923S ▪ Product page: www.endress.com/smt77 </p>

Service-specific accessories

Accessories	Description
Applicator	<p>Software for selecting and sizing Endress+Hauser measuring devices:</p> <ul style="list-style-type: none"> Choice of measuring devices for industrial requirements Calculation of all the necessary data for identifying the optimum flowmeter: e.g. nominal diameter, pressure loss, flow velocity and accuracy. Graphic illustration of the calculation results Determination of the partial order code, administration, documentation and access to all project-related data and parameters over the entire life cycle of a project. <p>Applicator is available:</p> <ul style="list-style-type: none"> Via the Internet: https://portal.endress.com/webapp/applicator As a downloadable DVD for local PC installation.
W@M	<p>W@M Life Cycle Management</p> <p>Improved productivity with information at your fingertips. Data relevant to a plant and its components is generated from the first stages of planning and during the asset's complete life cycle.</p> <p>W@M Life Cycle Management is an open and flexible information platform with online and on-site tools. Instant access for your staff to current, in-depth data shortens your plant's engineering time, speeds up procurement processes and increases plant uptime.</p> <p>Combined with the right services, W@M Life Cycle Management boosts productivity in every phase. For more information, visit www.endress.com/lifecyclemanagement</p>
FieldCare	<p>FDT-based plant asset management tool from Endress+Hauser. It can configure all smart field units in your system and helps you manage them. By using the status information, it is also a simple but effective way of checking their status and condition.</p> <p> Operating Instructions BA00027S and BA00059S</p>
DeviceCare	<p>Tool to connect and configure Endress+Hauser field devices.</p> <p> Innovation brochure IN01047S</p>

System components

Accessories	Description
Memograph M graphic data manager	<p>The Memograph M graphic data manager provides information on all the relevant measured variables. Measured values are recorded correctly, limit values are monitored and measuring points analyzed. The data are stored in the 256 MB internal memory and also on a SD card or USB stick.</p> <p> <ul style="list-style-type: none"> Technical Information TI00133R Operating Instructions BA00247R </p>
Cerabar M	<p>The pressure transmitter for measuring the absolute and gauge pressure of gases, steam and liquids. It can be used to read in the operating pressure value.</p> <p> <ul style="list-style-type: none"> Technical Information TI00426P and TI00436P Operating Instructions BA00200P and BA00382P </p>
Cerabar S	<p>The pressure transmitter for measuring the absolute and gauge pressure of gases, steam and liquids. It can be used to read in the operating pressure value.</p> <p> <ul style="list-style-type: none"> Technical Information TI00383P Operating Instructions BA00271P </p>
iTEMP	<p>The temperature transmitters can be used in all applications and are suitable for the measurement of gases, steam and liquids. They can be used to read in the medium temperature.</p> <p> "Fields of Activity" document FA00006T</p>

Supplementary documentation



For an overview of the scope of the associated Technical Documentation, refer to the following:

- *W@M Device Viewer* (www.endress.com/deviceviewer): Enter the serial number from nameplate
- *Endress+Hauser Operations App*: Enter the serial number from the nameplate or scan the 2D matrix code (QR code) on the nameplate

Standard documentation Brief Operating Instructions

Brief Operating Instructions for the sensor

Measuring device	Documentation code
Proline Promass Q	KA01262D

Brief Operating Instructions for transmitter

Measuring device	Documentation code						
	HART	FOUNDATION Fieldbus	PROFIBUS PA	PROFIBUS DP	Modbus RS485	EtherNet/IP	PROFINET
Proline 300	KA01309D	KA01229D	KA01227D	KA01386D	KA01311D	KA01339D	KA01341D

Operating Instructions

Measuring device	Documentation code						
	HART	FOUNDATION Fieldbus	PROFIBUS PA	PROFIBUS DP	Modbus RS485	EtherNet/IP	PROFINET
Promass Q 300	BA01490D	BA01523D	BA01512D	BA01862D	BA01501D	BA01733D	BA01744D

Description of Device Parameters

Measuring device	Documentation code						
	HART	FOUNDATION Fieldbus	PROFIBUS PA	PROFIBUS DP	Modbus RS485	EtherNet/IP	PROFINET
Promass 300	GP01057D	GP01094D	GP01058D	GP01134D	GP01059D	GP01114D	GP01115D

Device-dependent additional documentation

Safety instructions

Safety instructions for electrical equipment for hazardous areas.

Contents	Documentation code
ATEX/IECEX Ex d/Ex de	XA01405D
ATEX/IECEX Ex ec	XA01439D
cCSAus XP	XA01373D
cCSAus Ex d/ Ex de	XA01372D
cCSAus Ex nA	XA01507D
INMETRO Ex d/Ex de	XA01468D
INMETRO Ex ec	XA01470D
NEPSI Ex d/Ex de	XA01469D
NEPSI Ex nA	XA01471D
EAC Ex d/Ex de	XA01656D

Contents	Documentation code
EAC Ex nA	XA01657D
JPN Ex d	XA01778D

Remote display and operating module DKX001

Contents	Documentation code
ATEX/IECEX Ex i	XA01494D
ATEX/IECEX Ex ec	XA01498D
cCSAus IS	XA01499D
cCSAus Ex nA	XA01513D
INMETRO Ex i	XA01500D
INMETRO Ex ec	XA01501D
NEPSI Ex i	XA01502D
NEPSI Ex nA	XA01503D

Special Documentation

Contents	Documentation code
Information on the Pressure Equipment Directive	SD01614D
Functional Safety Manual	SD01727D
Remote display and operating module DKX001	SD01763D
Radio approvals for WLAN interface for A309/A310 display module	SD01793D
OPC-UA Server ¹⁾	SD02039D

1) This Special Documentation is only available for device versions with a HART output.

Contents	Documentation code						
	HART	FOUNDATION Fieldbus	PROFIBUS PA	PROFIBUS DP	Modbus RS485	PROFINET	EtherNet/IP
Web server	SD01662D	SD01665D	SD01664D	SD02226D	SD01663D	SD01969D	SD01968D
Heartbeat Technology	SD01642D	SD01696D	SD01698D	SD02202D	SD01697D	SD01988D	SD01982
Concentration measurement	SD01644D	SD01706D	SD01708D	SD02212D	SD01707D	SD02005D	SD02004D
Petroleum	SD02097D	-	SD02291D	SD02216D	SD02098D	SD02099D	SD02096D
Custody transfer	SD01688D	-	-	-	SD01689D	-	-

Installation Instructions

Contents	Comment
Installation instructions for spare part sets and accessories	Documentation code: specified for each individual accessory → 103.

Registered trademarks

HART®

Registered trademark of the FieldComm Group, Austin, Texas, USA

PROFIBUS®

Registered trademark of the PROFIBUS User Organization, Karlsruhe, Germany

FOUNDATION™ Fieldbus

Registration-pending trademark of the FieldComm Group, Austin, Texas, USA

Modbus®

Registered trademark of SCHNEIDER AUTOMATION, INC.

EtherNet/IP™

Trademark of ODVA, Inc.

PROFINET®

Registered trademark of the PROFIBUS User Organization, Karlsruhe, Germany



www.addresses.endress.com
