



Pneumatically operated 3/2-way seat valve CLASSIC

- For mixing or distributing of media
- Controlled by a pilot valve or centrally by a valve island
- Flow-optimised body in stainless steel
- Long life time and maintenance-free operation

Product variants described in the data sheet may differ from the product presentation and description.

Can be combined with

	Type 8697 Pneumatic control unit for decentralised automation of process valves ELEMENT	▶
	Type 8640 Modular valve island for pneumatics	▶
	Type 8644 AirLINE SP electropneumatic automation system	▶
	Type 6014 Plunger valve 3/2-way direct-acting	▶
	Type 8840 Modular process valve cluster – distributor and collector	▶

Type description

The Bürkert 3/2-way seat valve Type 2006 consists of a pneumatically operated CLASSIC actuator and a 3-way valve body. The actuator is available in two different materials, PA or PPS, depending on the ambient temperature. Interchanging of pressure and working connections enables different fluidic control functions, such as the mixing or distributing of media. The flow-optimised valve body Type 2006 allows excellent flow values. The tried-and-tested self-adjusting packing gland secures a high level of tightness and thus ensures reliable operation over years. The 3-way valve Type 2006 is controlled by a pilot valve or by centralised automation using a valve island. It can be equipped easily with electrical position feedback. For the user, the compact Type 2006 is thus often an economic alternative instead of two single shut-off valves.

DTS 1000257612 EN Version: L Status: RL (released | freigegeben | valide) printed: 22.07.2025

Table of contents

1. General technical data	3
<hr/>	
2. Control functions	4
2.1. Control function	4
2.2. Pin assignment for flow modes of operation C, D, E and F	4
<hr/>	
3. Approvals and conformities	5
3.1. General notes	5
3.2. Conformity	5
3.3. Standards	5
3.4. Explosion protection.....	5
3.5. Drinking water	5
3.6. Foods and beverages/Hygiene	6
3.7. Others	6
DNV GL classification.....	6
Oxygen	6
Fuel gases	6
<hr/>	
4. Materials	7
4.1. Bürkert resistApp.....	7
4.2. Material specifications	7
<hr/>	
5. Dimensions	8
<hr/>	
6. Performance specifications	9
6.1. Fluidic data	9
Pilot pressure diagram	9
6.2. Operating limits	10
Operating limits ambient and medium temperature.....	10
<hr/>	
7. Ordering information	11
7.1. Bürkert eShop	11
7.2. Bürkert product filter	11
7.3. Bürkert Product Enquiry Form	11
7.4. Ordering chart threaded connection	12
7.5. Ordering chart accessories.....	13
3/2-way pilot valves with banjo bolts	13
Cable plug Type 2507, Form B or Type 2518, Form A	13
Type 8697 pneumatic position feedback unit.....	14
Adapter kits.....	14

DTS 1000257612 EN Version: L Status: RL (released | freigegeben | valide) printed: 22.07.2025

1. General technical data

Product properties	
Dimensions	Further information can be found in chapter "5. Dimensions" on page 8.
Material	
Body	Stainless steel 316L
Actuator	PA (PPS on request)
Seal	PTFE
Packing gland (with silicone grease)	PTFE V-rings with spring compensation
Nominal diameter (port connection)	DN 15...DN 50, NPS ½...NPS 2
Performance data	
Nominal pressure	PN 16 (body)
Pilot pressure	Max 10 bar(g) 7 bar(g) with actuator size Ø 125 mm
Medium data	
Medium	Steam, water, neutral gases, alcohols, oils, fuels, hydraulic fluids, salt solutions, alkalis, organic solvents, oxygen and fuel gases of families I, II and III in accordance with the Gas Appliances Regulation (EU) 2016/426
Medium temperature	- 10 °C...+ 180 °C
Viscosity	Max. 600 mm ² /s
Control medium	Air, neutral gases
Product connections	
Port connection	
Threaded connection	G (DIN ISO 228 - 1) NPT (ASME B1.20.1) (RC on request)
Approvals and conformities	
Further information can be found in chapter "3. Approvals and conformities" on page 5.	
Material certificate	2.2, 3.1
Environment and installation	
Ambient temperature	
PA actuator	- 10 °C...+ 60 °C
PPS actuator	
Actuator size Ø 50 (D)...80 (F)	+ 5 °C...+ 140 °C
Actuator size Ø 125 (H)	+ 5 °C...+ 90 °C (short-term...+ 140 °C)
Installation position	As required, preferably with actuator in upright position

2. Control functions

2.1. Control function

Symbol	Description
	Control function C (CF C) Pneumatically operated 3/2-way process valve When de-energised, pressure port 1 closed, service port 2 exhausted
	Control function D (CF D) Pneumatically operated 3/2-way process valve When de-energised, pressure port 3 connected to service port 2, exhaust port 1 closed
	Control function E (CF E) Pneumatically operated 3/2-way mixer valve When de-energised, pressure port 3 connected to service port 2, pressure port 1 closed
	Control function F (CF F) Pneumatically operated 3/2-way distributor valve When de-energised, pressure port 2 connected to service port 3, service port 1 closed

2.2. Pin assignment for flow modes of operation C, D, E and F

Note:

- Actuator with control function A
- When de-energised, port connection 1 is closed with spring

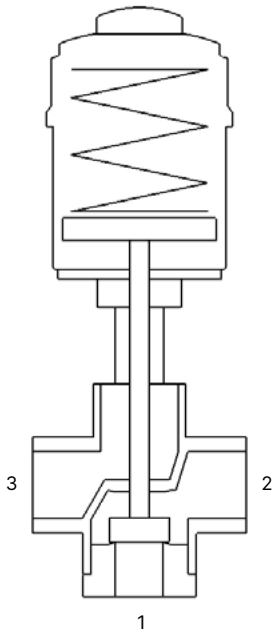

Flow modes of operation	Connection		
	1	2	3
C	P	A	R
D	R	A	P
E	P1	A	P2
F	A	P	B

A, B Service ports
 P, P1, P2 Pressure ports
 R Exhaust port

3. Approvals and conformities

3.1. General notes

- The approvals and conformities listed below must be stated when making enquiries. This is the only way to ensure that the product complies with all required specifications.
- Not all available variants can be supplied with the below mentioned approvals or conformities.

3.2. Conformity



In accordance with the Declaration of Conformity, the product is compliant with the EU Directives. This includes the following directives:

- Pressure Equipment Directive 2014/68/EU
- Machinery Directive 2006/42/EC

3.3. Standards

The applied standards which are used to demonstrate compliance with the EU Directives are listed in the EU-Type Examination Certificate and/or the EU Declaration of Conformity.

3.4. Explosion protection

Approval	Description																
 	<p>Optional: Explosion protection (valid for the variable code PX51) As a category 2 device suitable for zone 1/21 and zone 2/22.</p> <p>ATEX: EPS 18 ATEX 2 008 X II 2G Ex h IIC T4...T2 Gb II 2D Ex h IIIC T135 °C...T300 °C Db</p> <p>IECEx: IECEx EPS 18.0007X Ex h IIC T4...T2 Gb Ex h IIIC T135 °C...T300 °C Db</p> <table border="1"> <thead> <tr> <th>Temperature class</th> <th>T2</th> <th>T3</th> <th>T4</th> </tr> </thead> <tbody> <tr> <td>Maximum surface temperature</td> <td>+ 300 °C</td> <td>+ 200 °C</td> <td>+ 135 °C</td> </tr> <tr> <td>Ambient temperature</td> <td>- 40...+ 130 °C</td> <td>- 40...+ 130 °C</td> <td>- 40...+ 100 °C</td> </tr> <tr> <td>Maximum medium temperature</td> <td>+ 285 °C</td> <td>+ 185 °C</td> <td>+ 125 °C</td> </tr> </tbody> </table> <p>Note: The ambient and medium temperature range may be limited by non-ex-relevant specifications. Observe the Operating Instructions.</p>	Temperature class	T2	T3	T4	Maximum surface temperature	+ 300 °C	+ 200 °C	+ 135 °C	Ambient temperature	- 40...+ 130 °C	- 40...+ 130 °C	- 40...+ 100 °C	Maximum medium temperature	+ 285 °C	+ 185 °C	+ 125 °C
Temperature class	T2	T3	T4														
Maximum surface temperature	+ 300 °C	+ 200 °C	+ 135 °C														
Ambient temperature	- 40...+ 130 °C	- 40...+ 130 °C	- 40...+ 100 °C														
Maximum medium temperature	+ 285 °C	+ 185 °C	+ 125 °C														

3.5. Drinking water

Conformity	Description
	<p>Suitable for use in drinking water applications The materials comply with the assessment principles (UBA) for materials in contact with drinking water (TrinkwasserV).</p> <p>Stainless steel body PF39: Suitable for products with medium temperature up to 85 °C (hot water)</p>

DTS 1000257612 EN Version: L Status: RL (released | freigegeben | valide) printed: 22.07.2025

3.6. Foods and beverages/Hygiene

Conformity	Description
FDA	FDA – Code of Federal Regulations (valid for the variable code PL02) All wetted materials are compliant with the Code of Federal Regulations published by the FDA (Food and Drug Administration, USA) according to the manufacturer's declaration.
	EC Regulation 1935/2004 of the European Parliament and of the Council (valid for the variable code PL01, PL02) All wetted materials are compliant with EC Regulation 1935/2004/EC according to the manufacturer's declaration.
	China food GB Standards of the People's Republic of China (valid for the variable code PL10) All wetted materials are compliant with the requirement of China food GB Standards according to the manufacturer's declaration.

3.7. Others

DNV GL classification

Approval	Description
	DNV GL classification – Ships, offshore units, and high speed and light craft The products are accepted for installation on all vessels classed by DNV GL.

Oxygen

Conformity	Description
	Optional: Suitability for oxygen (valid for the variable code NL02) The products are suitable for use with gaseous oxygen, according to the manufacturer's declaration.

Fuel gases

Conformity	Description
	Fuel gases (valid for the variable code PO20) The products comply with: <ul style="list-style-type: none"> • Regulation (EU) 2016/426 – Appliances burning gaseous fuels and • DVGW DIN EN 161 (Automatic shut-off valves for gas burners and gas appliances) and • DIN EN 16678 Class D (Safety and control devices for gas burners and gas burning appliances – Automatic shut-off valves for operating pressure of above 500 kPa up to and including 6 300 kPa)

DTS 1000257612 EN Version: L Status: RL (released | freigegeben | valide) printed: 22.07.2025

4. Materials

4.1. Bürkert resistApp

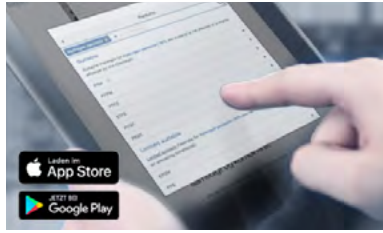

Bürkert resistApp – Chemical resistance chart

You want to ensure the reliability and durability of the materials in your individual application case? Verify your combination of media and materials on our website or in our resistApp.

[Start chemical resistance check](#)

4.2. Material specifications

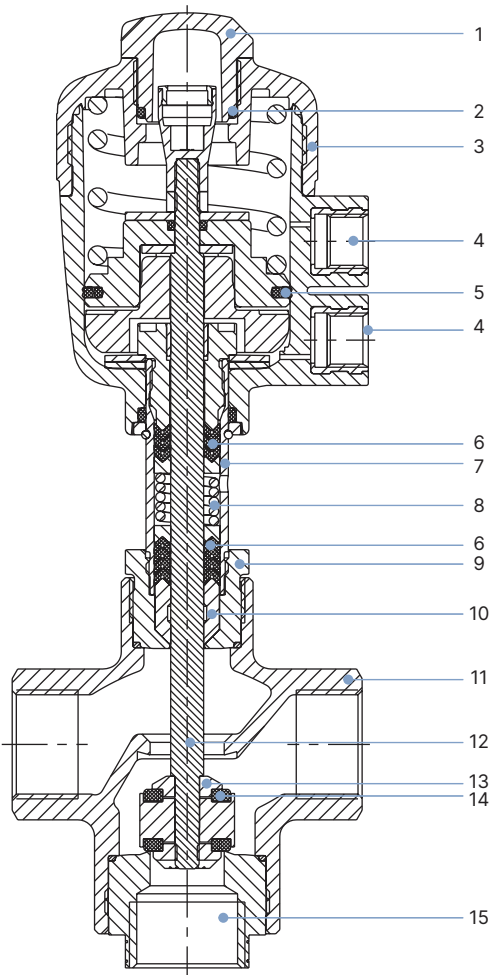

No.	Element	Material
1	Transparent cap	Polycarbonate (PC) (with PPS actuator: PSU)
2	O-Ring	FKM
3	Actuator	Polyamide (PPS)
4	Pilot air ports G 1/4	Stainless steel 1.4305
5	Piston seal	NBR (with PPS actuator: FKM)
6	Spindle seal	PTFE
7	Pipe ¹⁾	Stainless steel 1.4401 / 316 Stainless steel 1.4404 / 316L ²⁾
8	Spring	Stainless steel 1.4310
9	Nipple ¹⁾	Stainless steel 1.4401 / 316 Stainless steel 1.4404 / 316L ²⁾
10	Wiper	PTFE PEEK ³⁾
11	Valve body	Stainless steel 1.4404 / 316L
12	Spindle	Stainless steel 1.4404 / 316L
13	Seal holder	Stainless steel 1.4404 / 316L
14	Seat seal	PTFE
15	Seat nipple	Stainless steel 1.4404 / 316L

1.) In one piece for the actuator size 63 mm to 125 mm

2.) For actuator size 63 mm to 125 mm

3.) For actuator size 125 mm

5. Dimensions

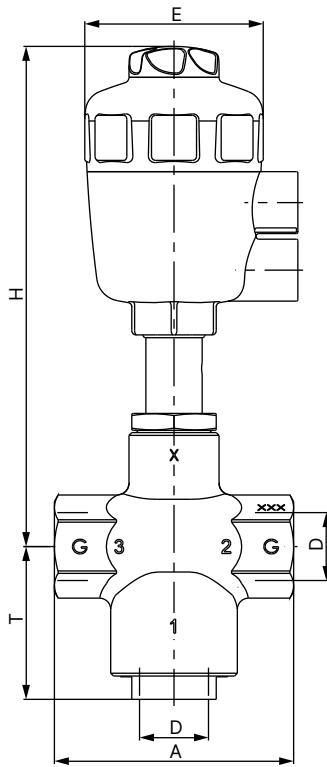

Nominal diameter (port connection)	Actuator size Ø	Port connection D	A	E	H	T
15	50 (D)	G ½	85	64	178	54
	63 (E)			80		
20	50 (D)	G ¾	85	64	178	54
	63 (E)			80		
25	63 (E)	G 1	105	80	220	54
32	80 (F)	G 1¼	130	101	249	68
	125 (H)			158		
40	63 (E)	G 1½	130	80	226	68
	80 (F)			101		
	125 (H)			158		
50	125 (H)	G 2	150	158	352	72

6. Performance specifications

6.1. Fluidic data

Pilot pressure diagram

Note:

CF A, flow direction 3 → 2

Actuator size Ø 50 mm

Maximum control pressure 10 bar(g)

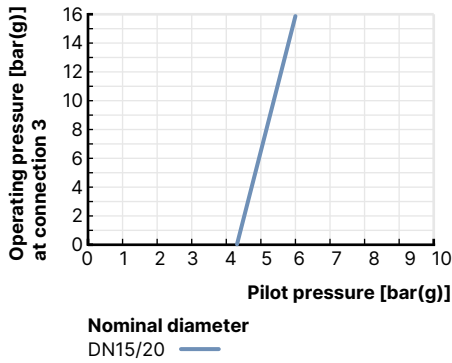

Actuator size Ø 63 mm

Maximum control pressure 10 bar(g)

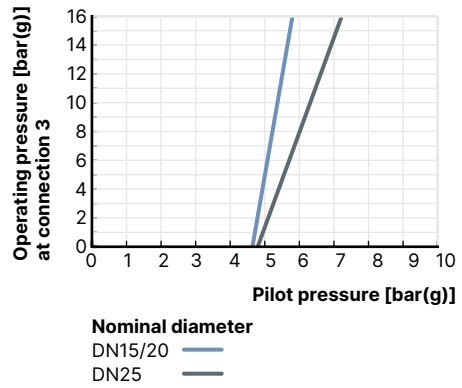

Actuator size Ø 80 mm

Maximum control pressure 10 bar(g)

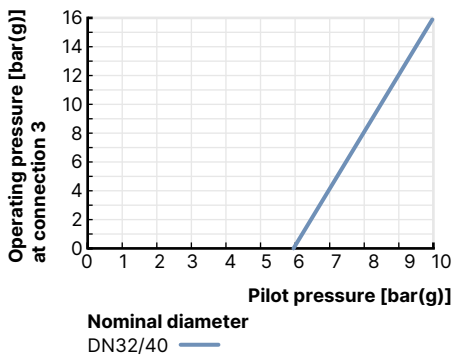

Actuator size Ø 125 mm

Maximum control pressure 7 bar(g)

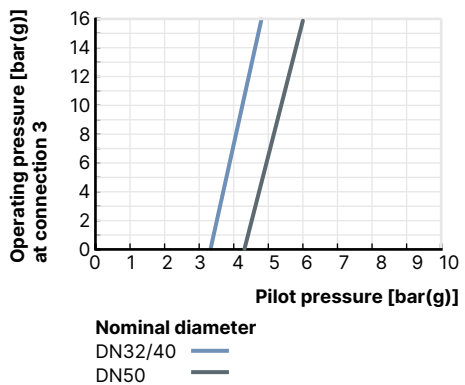

6.2. Operating limits

Operating limits ambient and medium temperature

Note:

For sizes 50 (D) and 63 (E) PA actuators, the combination of maximum medium temperature and maximum ambient temperature is shown in the following diagram:

Actuator size Ø 50 mm

Maximum control pressure 10 bar(g)

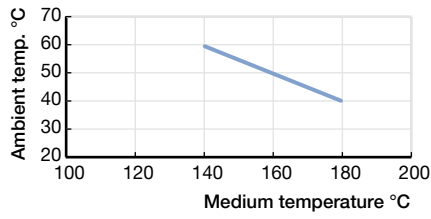

Actuator size Ø 63 mm

Maximum control pressure 10 bar(g)

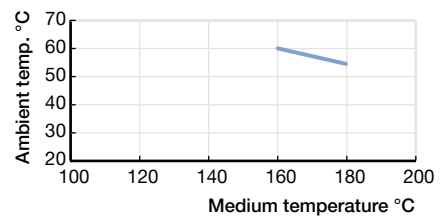

7. Ordering information

7.1. Bürkert eShop



Bürkert eShop – Easy ordering and quick delivery

You want to find your desired Bürkert product or spare part quickly and order directly? Our online shop is available for you 24/7. Sign up and enjoy all the benefits.

[Order online now](#)

7.2. Bürkert product filter



Bürkert product filter – Get quickly to the right product

You want to select products comfortably based on your technical requirements? Use the Bürkert product filter and find suitable articles for your application quickly and easily.

[Try out our product filter](#)

7.3. Bürkert Product Enquiry Form

Note:

Please see our Product Enquiry Form for a full explanation of our specification key.

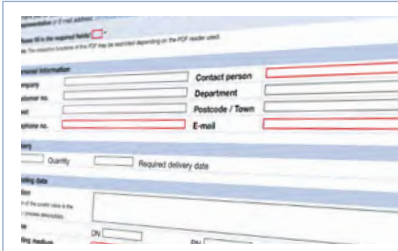

Bürkert Product Enquiry Form – Your enquiry quickly and compactly

Would you like to make a specific product enquiry based on your technical requirements? Use our Product Enquiry Form for this purpose. There you will find all the relevant information for your Bürkert contact. This will enable us to provide you with the best possible advice.

[Fill out the form now](#)

DTS 1000257612 EN Version: L Status: RL (released | freigegeben | valide) printed: 22.07.2025

7.4. Ordering chart threaded connection

Note:

- Port 1 closed by spring action
- Other variants are available on request

Control function	Nominal diameter (port connection)	Port connection	Actuator size Ø	K _v value water		Pilot pressure min.	Operating pressure max. up to 180 °C		Weight	Article no.	
				1→2	2→3		1→2	2→3		PA actuator	PPS actuator
				[m ³ /h]			[bar(g)]				
DN	[mm]	[mm]	[m ³ /h]	[bar(g)]	[bar(g)]	[kg]					
EN ISO 228 - 1											
A (CF A) see control functions ^{1) 2)}	15	G ½	50 (D)	7	4.5	4.4	11	16	1.3	287191	287202
			63 (E)	8	4.5	4.7	16	16	1.6	287192	287203
	20	G ¾	50 (D)	9	6.2	4.4	11	16	1.3	287193	287204
			63 (E)	11	5.6	4.7	16	16	1.6	287194	287205
	25	G 1	63 (E)	17	11	4.9	10	16	2.1	287195	287206
	32	G 1¼	80 (F)	32	21	6.0	9	16	4.3	287196	287207
			125 (H)	35	24	3.4	14	16	8.1	287197	287208
	40	G 1½	80 (F)	35	24	6.0	9	16	4.3	287199	287210
			125 (H)	35	24	3.4	14	16	8.1	287200	287211
	50	G 2	125 (H)	51	35	4.3	10	16	9.5	287201	287212
ANSI B 1.20.1											
A (CF A) see control functions ^{1) 2)}	15	NPT ½	50 (D)	7	4.5	4.4	11	16	1.3	292542	292553
			63 (E)	8	4.5	4.7	16	16	1.6	292543	292554
	20	NPT ¾	50 (D)	9	6.2	4.4	11	16	1.3	292544	292555
			63 (E)	11	5.6	4.7	16	16	1.6	292545	292556
	25	NPT 1	63 (E)	17	11	4.9	10	16	2.1	292546	292557
	32	NPT 1¼	80 (F)	32	21	6.0	9	16	4.3	292547	292558
			125 (H)	35	24	3.4	14	16	8.1	292548	292559
	40	NPT 1½	80 (F)	35	24	6.0	9	16	4.3	292550	292560
			125 (H)	35	24	3.4	14	16	8.1	292551	292561
	50	NPT 2	125 (H)	51	35	4.3	10	16	9.5	292552	292562

1.) For more information, refer to the chapter "2. Control functions" on page 4.

2.) See "2.2. Pin assignment for flow modes of operation C, D, E and F" on page 4

Further variants on request



Process connection





Rc thread

7.5. Ordering chart accessories



3/2-way pilot valves with banjo bolts

Note:

- Seal material of valve is FKM, seal material of banjo bolt is NBR
- For further accessories see the accessories data sheet **Type 2XXX** ▶

Valve for actuator size Ø [mm]	Type	Pressure inlet P (valve body)	Working port A (banjo bolt)	Nominal diameter (port connection)	Q _{Nn} value air	Pressure range	Electrical coil connection industry standard	Power consumption [W]	Article no. per voltage/frequency [V/Hz]	
				[mm]	[l/min]	[bar(g)]			024/DC	230/50
50 (D)... 63 (E)	6012P	Push-in connector Ø 6 mm	G ¼	1.2	48	0...10	Form B	4	552283 	552286 
50 (D)... 125	6014P	G ¼	G ¼	2	120	0...10	Form A	8	424103 	424107 











Cable plug Type 2507, Form B or Type 2518, Form A

Variant	Voltage	Article no.
Type 2507, Form B industry standard, without circuitry (Type 6012 P)	0...250 V	423845 
Type 2518, Form A according to DIN EN 175301 - 803, without circuitry	0...230 V/AC/DC	314802 

Type 8697 pneumatic position feedback unit

Note:

cULus only valid for variants without ATEX approval

End position feedback						Electrical connection	ATEX / IECEx Cat. 3D/G Zone 22/2 ¹⁾	ATEX / IECEx Cat. 2D/G Zone 21/1 ²⁾	ATEX / IECEx Cat. 2G Zone 1 ³⁾	cULus	Article no. Actuator series CLASSIC Type 20xx
Inductive switch 3-wire PNP	Inductive switch 2-wire NAMUR	Inductive switch 2-wire 24 V DC	Micro switch 24 V DC	Micro switch 50...250 V AC/DC	Feed-back status LEDs						
Feedback (without pilot valve)											
2	–	–	–	–	Yes	Cable bushing	–	–	–	Yes	248827 
2	–	–	–	–	Yes	Cable bushing	Yes	–	–	–	255851 
2	–	–	–	–	Yes	M12 multipole	Yes	–	–	–	255858 
2	–	–	–	–	Yes	M12 multipole	–	–	–	Yes	250472 
–	2	–	–	–	Yes	Cable bushing	–	Yes	–	–	248831 
–	2	–	–	–	Yes	Cable bushing	–	–	Yes	–	255863 
–	–	2	–	–	Yes	Cable bushing	–	–	–	Yes	248826 
–	–	2	–	–	Yes	Cable bushing	Yes	–	–	–	255850 
–	–	–	2	–	–	Cable bushing	–	–	–	Yes	248833 
–	–	–	–	2	–	Cable bushing	–	–	–	Yes	248825 

1.) II 3D Ex tc IIIC T135 / II 3G Ex nA IIC T4 Gc

2.) II 2D Ex ia IIIC T135 °C IP64 / II 2G Ex ia IIC T4 Gb

3.) II 2G Ex ia IIC T4 Gb

Adapter kits

Note:

Further information can be found in [data sheet Type 8697](#) ►.

Description	Actuator size	Control function	Article no.
Adapter kit for Type 8697	Ø 50 (C) / 63 (E) / 80 (F) mm	Universal	682264 
Adapter kit for Type 8697	Ø 125 mm	Universal	682265 