

P5 Pneumatic Positioner

Product
Information

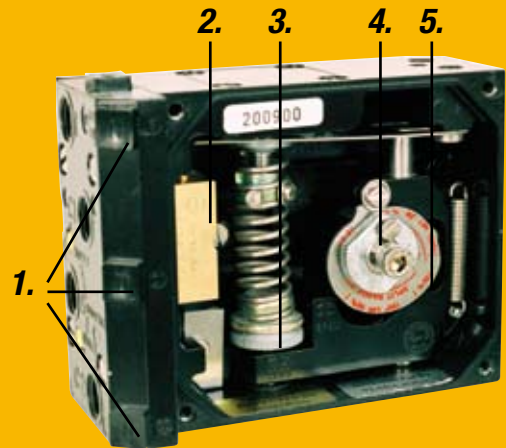

1. Gauge ports
2. Gold plated spool valve
3. Simple calibration, external zero adjustment
4. Stainless cam
5. Simple cam locking



P5 Pneumatic Positioner

P5

- Sturdy, robust simple design
- Pilot valve with high gain
- Large, bright position indicator flat or Dome
- Stainless steel cam
- Threaded vent port
- Easy to add on feedback unit or I/P converter
- External zero adjustment
- Gauge ports standard

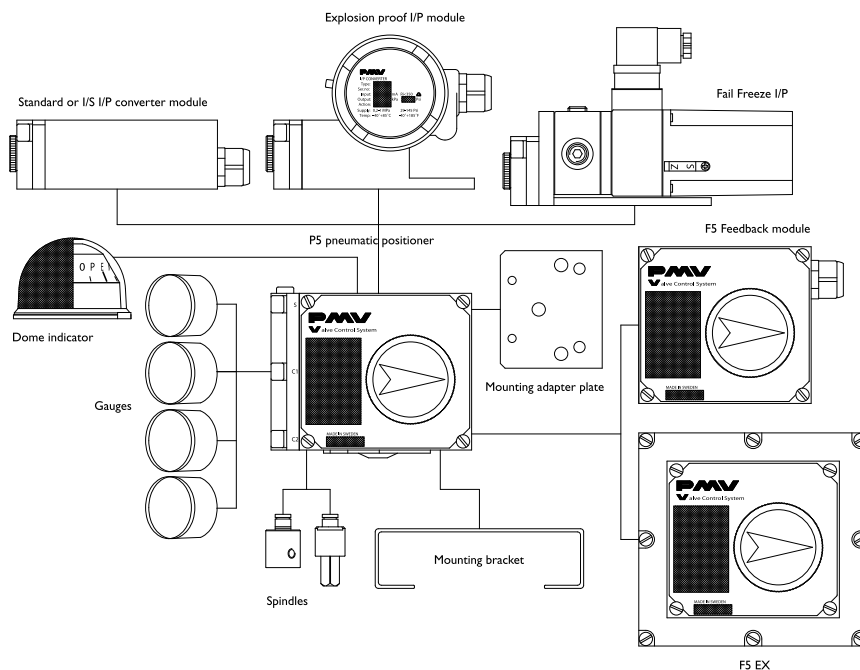



Technical data

Input signal	20 –100 kPa/3–15 Psi (6–30 Psi option)
Linearity	≤ 0.5%*
Hysteresis	≤ 0.5%*
Repeatability	≤ 0.5%*

Gain factor at: 600 KPa/87 Psi	High Performance Version	Normal Gain Version
	Min: 1000 KPa/KPa	Min: 450 KPa/KPa
	Min: 66%/ % ISA S75.13-1989	Min: 30%/ %

Max. air consumption at supply pressure:

0.2 MPa/29 Psi	6.1 nl/min (0.22 SCFM)	2.7 nl/min (0.1 SCFM)
0.4 MPa/58 Psi	13.6 nl/min (0.48 SCFM)	6.1 nl/min (0.21 SCFM)
0.6 MPa/87 Psi	22 nl/min (0.78 SCFM)	9.9 nl/min (0.35 SCFM)
0.8 MPa/116 Psi	30.5 nl/min (1.08 SCFM)	13.7 nl/min (0.48 SCFM)
1 MPa/145 Psi	39 nl/min (1.38 SCFM)	17.5 nl/min (0.62 SCFM)

Min. air delivery at supply pressure:

0.2 MPa/29 Psi	200 nl/min (6.9 SCFM)	156 nl/min (5.5 SCFM)
0.4 MPa/58 Psi	370 nl/min (12.8 SCFM)	288 nl/min (10.1 SCFM)
0.6 MPa/87 Psi	540 nl/min (18.8 SCFM)	421 nl/min (14.8 SCFM)
0.8 MPa/116 Psi	710 nl/min (24.7 SCFM)	553 nl/min (19.4 SCFM)
1 MPa/145 Psi	880 nl/min (30.6 SCFM)	686 nl/min (24 SCFM)

Position sensitivity	None	
Supply pressure effect	Max. 1MPa/150Psi	
Temperature range	–20°C to +85°C/(–4°F to +185°F)	
Low temp option	–40°C to +85°C/(–40°F to +185°F)	
Connector threads	1/4" NPT or G (BSP)	
Gauge threads	1/8" NPT or G (BSP)	
Weight	1.1 kg/2.4 lbs	
Housing	Die cast aluminum	
Surface treatment	ED Epoxy paint, black	
Fasteners	A2/A4 Stainless	
Ingress protection	IP 66/NEMA 4	ATEX II 1 G

* Percent of full scale

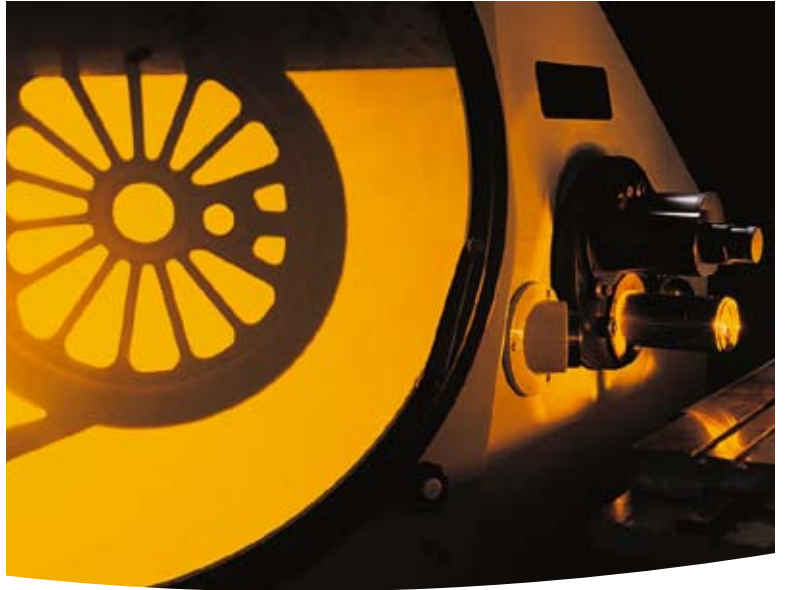

Modular

Simple to add on:

- Feedback Unit F5
- Dome Style Indicator
- I/P Converter



F5

P5 Series Coding

Model

- PP5 Double acting pneumatic
- PA5 Double acting pneumatic, ATEX

Spool valve

- HP High performance
- LB Normal Gain

Air Connections

- N NPT 1/4"
- G G 1/4"

Surface treatment

- U Epoxy coating
- M Tuftram

Spindle

- 01, 23 etc 01 to 39. See dwg SPNDLS_P5

Cam

- K01 K01 to K32, K01 = linear 90°, standard

Front cover

- PV9DA* 90°, Direct, arrow indicator

Input signal

- 3 3–15 psi
- 6 6–30 psi

Temperature

- Z Nitrite –20°C – +85°C
- Q Silicon seals, –40°C to +85°C

*For 30, 45, 60 deg rotation, change PV9 to PV3, PV4 or PV6

Example

PP5HPNU-23K01-PV9DA-3Z

Cams

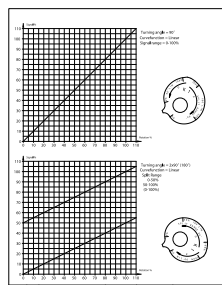

K1

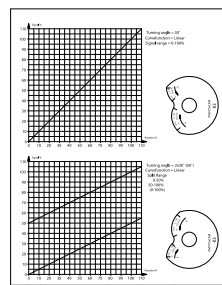

K3

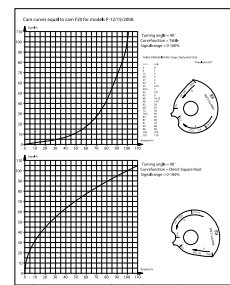

K8

Spindles

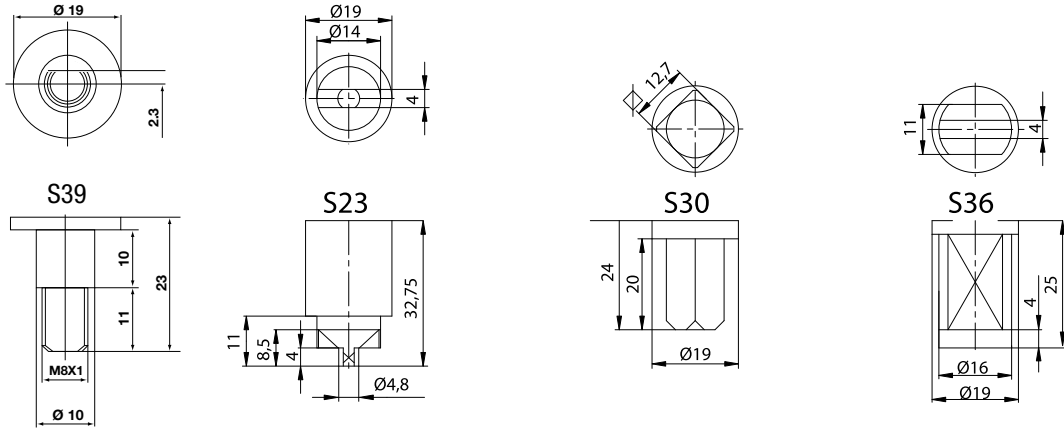

Dimensions drawings(mm)

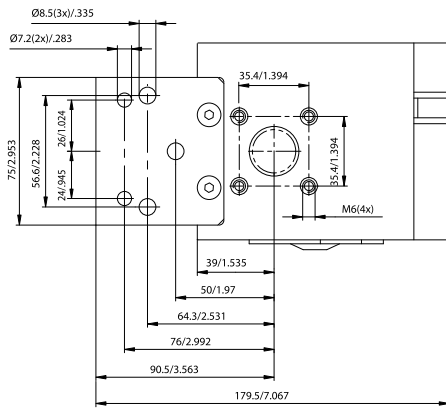

P5

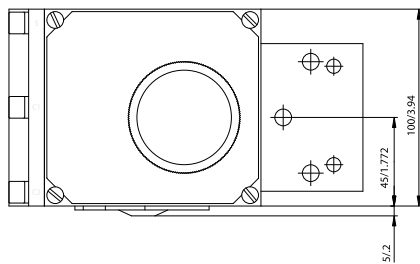

P5

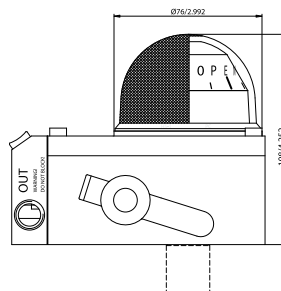

P5 with H5



p/n: FCD PMENBR0008-02



Hazardous Locations 

ATEX  II 1 G

Palmstierna International AB
Korta Gatan 9
SE-171 54 Solna
SWEDEN
Tel: +46 (0) 8 555 106 00
Fax: +46 (0) 8 555 106 01
E-mail: infopmv@flowserve.com

Germany
Flowserve
Sperberweg 16
D-41468 Neuss
GERMANY
Tel: +49 (0) 2131 795 74 80
Fax: +49 (0) 2131 795 74 99
E-mail: pmvgermany@flowserve.com

UK
Flowserve
Abex Road
Newbury, Berkshire, RG14 5EY
UK
Tel: +44 (0) 1635 46 999
Fax: +44 (0) 1635 36 034
E-mail: pmvukinfo@flowserve.com

Italy
Flowserve Spa
Via Prealpi, 30
20032 Cormano (Milano)
ITALY
Tel: +39 (0) 2 663 251
Fax: +39 (0) 2 615 18 63
E-mail: infoitaly@flowserve.com

USA, Mexico
PMV-USA
1440 Lake Front Circle, Unit 160
The Woodlands, TX 77380
USA
Tel: +1 281 292 7500
Fax: +1 281 292 7760
E-mail: pmvusa@flowserve.com

Canada
Cancoppas Limited
2595 Dunwin Drive, Unit 2
Mississauga, Ont L5L 3N9
CANADA
Tel: +1 905 569 6246
Fax: +1 905 569 6244
E-mail: controls@cancoppas.com

Asia Pacific Headquarters
Flowserve Pte Ltd.
No. 12 Tuas Avenue 20
REPUBLIC OF SINGAPORE 638824
Tel: +65 (0) 687 98900
Fax: +65 (0) 686 24940

South Africa
Flowserve
Unit 1, 12 Director Road
Spartan Ext. 2
1613 Kempton Park, Gauteng
SOUTH AFRICA
Tel: +27 (0) 11 397 3150
Fax: +27 (0) 11 397 5300

The Netherlands
Fabromatic BV
Rechtzaad 17
4703 RC Roosendaal
THE NETHERLANDS
Tel: +31 (0) 30 6771946
Fax: +27 (0) 30 6772471
E-mail: fcbinfo@flowserve.com

China
Flowserve
Hanwei Building
No. 7 Guanghua Road
Chao Yang District
100004 Beijing
CHINA
Tel: +86 (10) 6561 1900
Fax: +86 (10) 6561 1899

www.pmvnu

Flowserve Corporation has established industry leadership in the design and manufacture of its products. When properly selected, this Flowserve product is designed to perform its intended function safely during its useful life. However, the purchaser or user of Flowserve products should be aware that Flowserve products might be used in numerous applications under a wide variety of industrial service conditions. Although Flowserve can (and often does) provide general guidelines, it cannot provide specific data and warnings for all possible applications. The purchaser/user must therefore assume the ultimate responsibility for the proper sizing and selection, installation, operation, and maintenance of Flowserve products. The purchaser/user should read and understand the Installation and Maintenance (I & M) instructions included with the product, and train its employees and contractors in the safe use of Flowserve products in connection with the specific application.

While the information and specifications contained in this literature are believed to be accurate, they are supplied for informative purposes only and should not be considered certified or as a guarantee of satisfactory results by reliance thereon. Nothing contained herein is to be construed as a warranty or guarantee, express or implied, regarding any matter with respect to this product. Because Flowserve is continually improving and upgrading its product design, the specifications, dimensions and information contained herein are subject to change without notice. Should any question arise concerning these provisions, the purchaser/user should contact Flowserve Corporation at any one of its worldwide operations or offices.

©2007 Flowserve Corporation, Irving, Texas, USA. Flowserve and PMV are registered trademarks of Flowserve Corporation.