

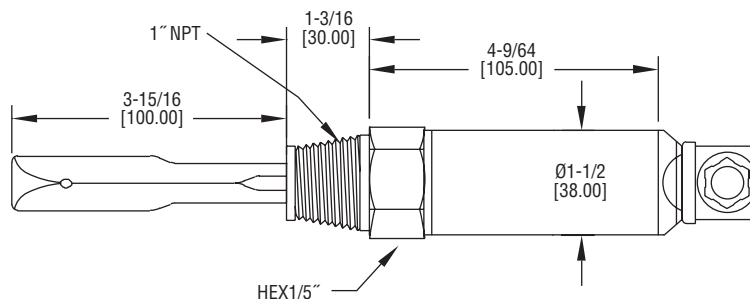

## Model CTF Mini Tuning Fork Level Switch

### Specifications - Installation and Operating Instructions



The **Model CTF Mini Tuning Fork Level Switch** is an ideal choice for level control of powders. The CTF incorporates a piezoelectric crystal that vibrates the fork at its natural frequency. When the fork comes in contact with a material, the vibration is dampened and the switch changes state. As the fork becomes free of material, the switch changes back to its normal state. The unit is not affected by vibration from conveying systems, motors, or the movement of material. Its compact size and DIN connection allow for application in places a larger tuning fork level switch may not be suitable, providing great versatility.

The Model CTF is easy to use with no calibration required and no mechanical moving parts, which means no routine maintenance. The CTF is not affected by the dielectric constant of the sensed material, making it superior to a comparable capacitance level switch for applications where the dielectric constant is low, more than one material is being used in the single vessel, and when material moisture content can change. The level switch is also great for applications when the bulk density is too low for a rotating paddle level switch, making it the ideal choice for low density bulk solids and liquids. Comes standard with a user friendly PNP or NPN output.

#### FEATURES

- Compact size for applications where a larger tuning fork is not suitable.
- PNP or NPN output modes
- DIN Connection
- Quality materials suitable for pharmaceutical and food processing applications
- Magnetic test point to test proper functionality of level switch

#### Electrical Connections:

To configure the switch for a PNP output, the following steps should be followed.

##### High (max) Mode:

1. Connect the negative supply terminal N- to pin no. 1.
2. Connect the positive supply terminal L+ to pin no. 3.
3. Connect ground to pin no. 4.
4. To connect to the output signal of the switch, connect between pin no. 2 and the negative supply terminal N-. (See PNP connection figure)

##### Low (in) Mode:

1. Connect the negative supply terminal N- to pin no. 1.
2. Connect the positive supply terminal L+ to pin no. 2.
3. Connect ground to pin no. 4. To connect to the output signal of the switch, connect between pin no. 3 and the negative supply terminal N-. (See PNP connection figure).

To configure the switch for an NPN output, the following steps should be followed.

#### SPECIFICATIONS

**Service:** Dry powder compatible with wetted materials. Can detect bulk materials submerged in liquid.

**Sensitivity:** Minimum bulk solid density: 4.4 lb/ft<sup>3</sup> (70 g/l).

**Wetted Materials:** Tuning fork: 316 SS; Process connection: 304 SS.

**Temperature Limits:** Ambient: -40 to 140°F (-40 to 60°C); Process: -40 to 212°F (-40 to 100°C).

**Pressure Limit:** 600 psi (40 bar).

**Power Requirement:** 12-55 VDC.

**Power Consumption:** 10 mA @ 12-24 VDC; 0.5 W (max).

**Enclosure:** Aluminum, painted.

**Enclosure Rating:** IP65.

**Switch Type:** 3-wire PNP or NPN output.

**Electrical Rating:** 350 mA (max) @ 12-55 VDC.

**Conduit Connection:** Valve plug DIN 43650.

**Process Connections:** 1" male NPT.

**Indication Lights:** External red LED.

**Sensing Delay:** Maximum covered probe: 1 to 3 s; Uncovered probe: 1 to 3 s.

**Weight:** 2.2 lb (1.0 kg).

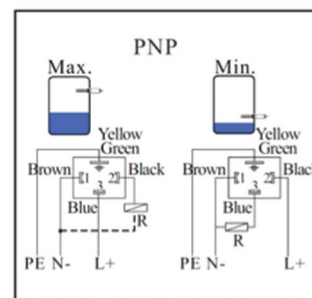

Figure 1: PNP output connection diagram

##### High (Max) Mode

1. Connect the positive supply terminal L+ to pin no. 1.
2. Connect the negative supply terminal N- to pin no. 3.
3. Connect ground to pin no. 4.
4. To connect to the output signal of the switch, connect between pin no. 2 and the positive supply terminal L+. (See NPN connection figure)

##### Low (Min) Mode

1. Connect the positive supply terminal L+ to pin no. 1.
2. Connect the negative supply terminal N- to pin no. 2.
3. Connect ground to pin no. 4.
4. To connect to the output signal of the switch, connect between pin no. 3 and the positive supply terminal L+. (See NPN connection figure)

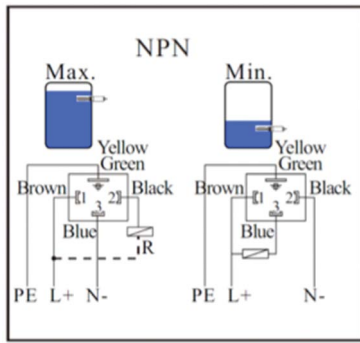

Figure 2: NPN output connection diagram

### Checking the Status of the Output

Depending on the configuration of the output and the mode of operation (max/min), the output status indicated by the red LED on the top of the housing will vary.

**Low (min) Mode:** The tuning fork level switch starts detection 3 seconds after power is connected. The switch will remain open and the red LED indicator will remain off until covered by a medium. Once the tuning fork is covered by this medium, the vibration will cease, the switch will close, and the red LED will turn on.

**High (max) Mode:** The tuning fork level switch starts detection 3 seconds after power is connected. The switch will remain closed and the red LED indicator will remain on until covered by a medium. Once the tuning fork is covered by this medium, the vibration will cease, the switch will open, and the red LED will turn off.

	Min. Mode		Max. Mode	
Level				
PNP/ NPN Output	Switch open	Switch closed	Switch closed	Switch open
Red LED				

Figure 3: Max/min mode output status indication

### Magnetic Testing of Functionality

Once tuning fork level switch is installed and powered, the CTF offers a magnetic switch test to check functionality. Depending on the proximity of magnet in relation to the magnetic test point, the switch will change from open to closed or closed to open, and the red LED will switch on or off depending on the mode configured. The purpose of the test is to confirm the wiring and functionality are correct.

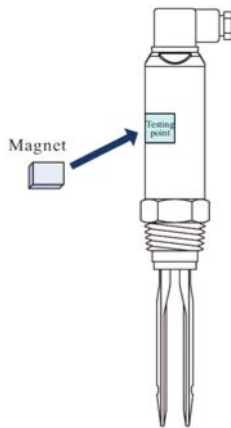

Figure 4: Magnetic test diagram

### Installation

The following steps should be followed for both horizontal and vertical installation.

#### Horizontal Installation

Level switch can be installed in powder and liquid. Do not install near substance inlet.

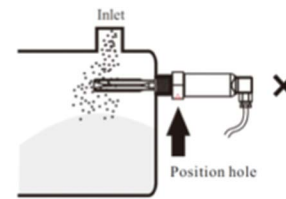

Figure 5: For proper operation, do not install near substance inlet

When installed, the tuning fork position hole on DIN plug must be faced in the downward direction. Fail to do so may damage the tuning fork.

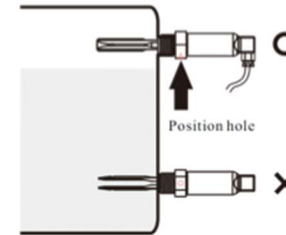

Figure 6: Position hole on DIN plug must be installed facing downward

#### Vertical Installation

When the level switch is installed in a liquid, the opening of the two fork blades is to be so the liquid flows between the blades.

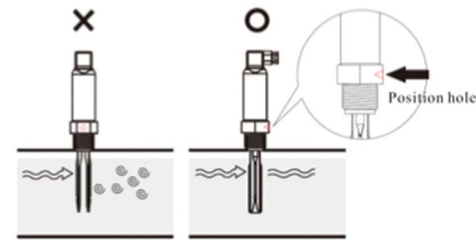

Figure 7: Vertical installation in a liquid's flow stream

Just as with horizontal installation, do not install the tuning fork near the substance inlet.

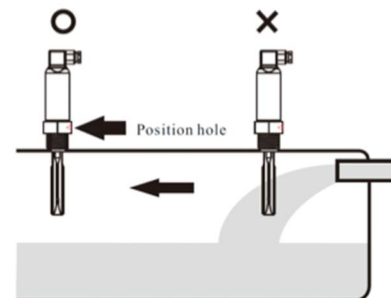

Figure 8: Do not install tuning fork near substance inlet

### MAINTENANCE/REPAIR

Upon final installation of the Model CTF, no routine maintenance is required. The Model CTF is not field serviceable and should be returned if repair is needed. Field repair should not be attempted and may void warranty.

### WARRANTY/RETURN

Refer to "Terms and Conditions of Sales" in our catalog and on our website. Contact customer service to receive a Return Goods Authorization number before shipping the product back for repair. Be sure to include a brief description of the problem plus any additional application notes.