



Q9 COMPUTER ELECTRONICS (Non-Agency)



Please save these instructions for future reference. Read carefully before attempting to assemble, install, operate or maintain the product described.

Protect yourself and others by observing all safety information. Failure to comply with instructions could result in personal injury and/or property damage.

Please refer to back cover for information regarding this product's warranty and other important information.

DO NOT RETURN THIS PRODUCT TO THE STORE!

Please contact Great Plains Industries, Inc.® before returning any product. If you are missing parts, or experience problems with your installation, contact our Customer Support Department. We will be happy to assist you.

Call: 888-996-3837 or 316-686-7361

Email: meters@gplains.com

SAVE FOR YOUR RECORDS

Model #: _____

Serial #: _____

Purchase Date: _____



NON-AGENCY APPROVED Q9 TABLE OF CONTENTS

Getting Started ----- 4

General Safety Instructions ----- 5

Electrical / Mechanical Specifications ----- 6

Approval Ratings ----- 9

Installation ----- 10

Operation ----- 11

Normal Operation Mode ----- 12

Diagnostic Mode ----- 14

Configuration Mode ----- 16

Configuration Process Map ----- 17

PIN ----- 18

Volume Unit ----- 19

Time Period ----- 21

Advanced Options ----- 22

Display Update Rate / Low Frequency Cutoff ----- 22

Calibration Selection ----- 23

Inner Pipe Diameter ----- 24

Daughter Board Options ----- 25

Field Calibration Mode ----- 26

Dispense Display ----- 27

Percent Adjust ----- 29

K-Factor Entry ----- 30

Troubleshooting ----- 32

Maintenance ----- 34

Parts & Service ----- 35

Warranty ----- 36

BEFORE YOU BEGIN

Usage

- This computer electronics is designed specifically for use on FLOMEC® Turbine housings. It is also designed to work with several other FLOMEC products.



Power Source Requirements

- This computer requires DC power. For this application, the power is provided by (2) AAA size alkaline batteries installed in the computer at the factory.



Tools and Materials Needed

- Phillips screwdriver.
-

UNPACKING



Contents

- Qty. 1 - Q9 Computer Electronics w/Batteries Installed
- Qty. 1 - Owner's Manual



Inspect

- Upon receipt, examine your equipment for visible damage. The computer is a precision measuring instrument and should be handled as such. If any items appear damaged or missing, contact your distributor.



- See General Safety Instruction, and all Cautions, Warnings, and Dangers as shown.

GENERAL SAFETY INSTRUCTIONS

Non-Agency Approved Q9 Computer Electronics

IMPORTANT: It is your responsibility to:

- Ensure that all equipment operators have access to adequate instructions concerning safe operating and maintenance procedures.

▲ WARNING

The apparatus enclosure may contain aluminum and is considered to constitute a potential risk of ignition by impact or friction. Care must be taken into account during installation and use to prevent impact or friction.

▲ WARNING

Part of the enclosure is constructed from plastic. To prevent the risk of electrostatic sparking, the plastic surface should only be cleaned with a damp cloth.

▲ WARNING

This product should never be electrically connected to any other device in the hazardous location. Consult manufacturer for exceptions.

▲ WARNING

Compatibility of this product's material and the process fluid and/or environment should be considered prior to putting into service.

▲ WARNING

This product should never be operated outside its published specifications for temperature.

▲ WARNING

(Battery) - Avoid mechanical or electrical abuse. Batteries may explode or cause burns, if disassembled, crushed, or exposed to fire or temperatures in excess of 212° F (100° C). Do not short circuit or install with incorrect polarity. **DO NOT INCINERATE.**

▲ WARNING

This product is **NOT INTENDED** for use with flammable liquids.

▲ WARNING

When handling hazardous liquids, always follow the liquid manufacturer's safety precautions.

▲ WARNING

This device will operate using off-the-shelf AAA size alkaline or lithium batteries. Do not mix brands or technologies. Do not mix old and new batteries. Do not use rechargeable batteries

- When working in hazardous environments, always exercise appropriate safety precautions.
- Open battery cells should be disposed of in accordance with local regulations. Lithium batteries are best disposed of as a non-hazardous waste when fully or mostly discharged. EPA does not list or exempt lithium as a hazardous waste. If waste lithium batteries are still fully charged or only partially discharged, they can be considered a reactive hazardous waste because of unconsumed lithium remaining in the battery. Such batteries may qualify as "Universal Waste" in many jurisdictions within the U.S. and thus can be shipped for disposal or recycling in accordance with Universal Waste requirements.

SPECIFICATIONS

Q9 COMPUTER ELECTRONICS

MECHANICAL	
Housing Material	Transparent Amorphous Nylon
Operating Temperature (Standard Display)	+0°F to +130°F (-18°C to +55°C) With following Alkaline batteries installed: Energizer, E92 or En92 (or) Duracell, Mn2400. ----- +0°F to +140°F (-18°C to +60°C) With following Lithium batteries installed: Energizer, L92.
Storage Temperature	-40°F to +158°F (-40°C to +70°C) With batteries removed from display.
Hi-Temp Display (G2S Meters Only)	See Ambient and Fluid Temperature Limits graph on next page. If wider operating temperature ranges are desired, reference information on FLOMEC® Remote Kits.
ELECTRICAL	
Input Pulse Rate	Frequency Range: 0.25 Hz – 3kHz
K-Factor	Minimum: 0.001 pulses/unit Maximum: >999,999 pulses/unit
Field Calibration Correction	Minimum: -99.999% Maximum: +99.999%
Readout Totals	Minimum Display: 0.001 Maximum Display: 999,999 (x100)
Field Calibration	Yes
Power	Internal Power Supply: (2) Alkaline AAA batteries @ 1.5-volts each Battery Life: 2+ years <i>NOTE: For externally powered daughter board modules see specific module owner's manual for voltage specifications.</i>
STANDARD FEATURES INCLUDE	
<ul style="list-style-type: none"> • (2) Totalizing Registers • (1) Factory Calibration Curve • (1) Field Calibration Curve • Rate of Flow Feature • Flowrate Time Period in Day, Hour, minutes, or Seconds 	

SPECIFICATIONS (continued)

AMBIENT AND FLUID TEMPERATURE LIMITS - HI-TEMP DISPLAY

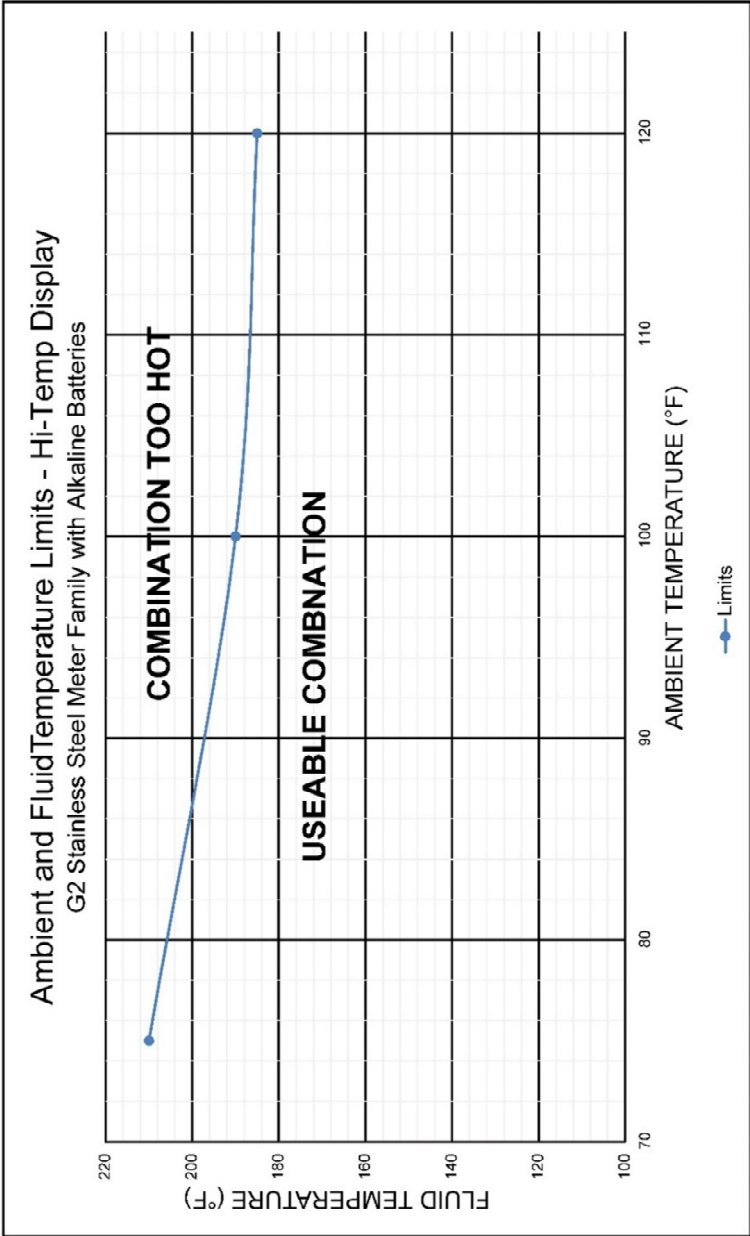

NOTE: The upper limit of the “Useable Combination” area can be increased by 10°F (6°C) when lithium batteries are installed in the Q9 Display.

SPECIFICATIONS (continued)

COMPUTER ELECTRONICS TERMINAL CONNECTIONS

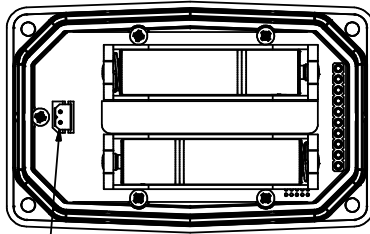

FEMALE TERMINAL HOUSING
(PICKUP COIL CONNECTION)

Figure 1

DIMENSIONS

	Length	Height	Height (Mounted)	Width (Widest Point)
Standard Display	A1	B1	C1	D1
	3.40 in. (8.6 cm)	0.85 in. (2.1 cm)	0.72 in. (1.8 cm)	2.14 in. (5.4 cm)
Hi-Temp Display (With Riser)	A2	B2	C2	D2
	3.45 in. (8.8 cm)	1.72 in. (4.4 cm)	1.62 in. (4.1 cm)	2.18 in. (5.5 cm)

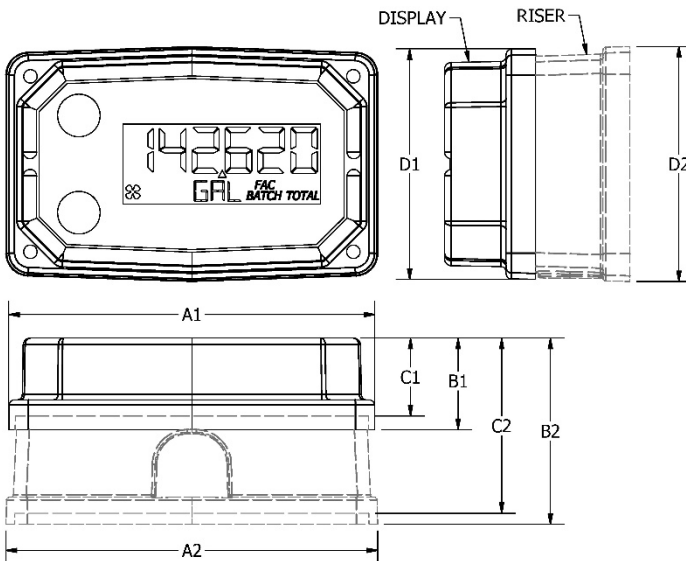

Figure 2

SPECIFICATIONS (continued)

COMPUTER DISPLAY FEATURES

Familiarize yourself with the computer features before installation and use.

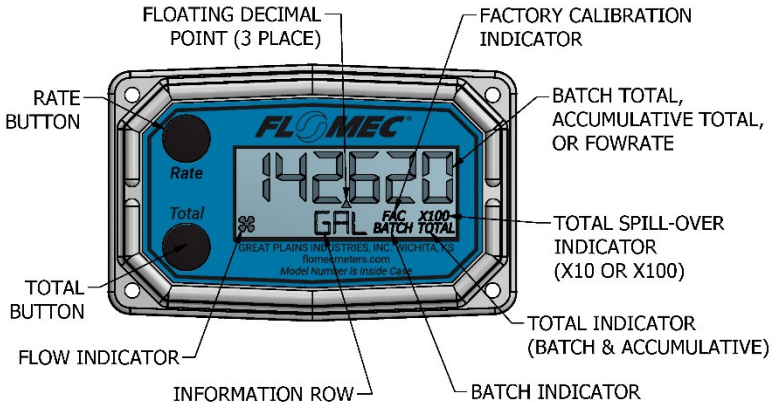

Figure 3

APPROVAL RATINGS

Q9 Computer Electronics



INSTALLATION

PRODUCT DESCRIPTION

This computer electronics is designed specifically for use on FLOMEC® Turbine Housings. It is also designed to work with several accessory output modules.

The CMOS, microprocessor-based electronics have extremely low power requirements and data retention capabilities in both RAM and ROM. Information is clearly displayed on a large 6-digit LCD readout with three-point floating decimal for totals from .001 to 999,999 (x1), 9,999,990 (x10), or 99,999,900 (x100). All operations are easily accessed with the two buttons on the front panel.

In a FLOMEC turbine meter, liquid flows through the turbine housing causing an internal rotor to spin. As the rotor spins, an electrical signal is generated in the pickup coil. This pulse data from the turbine is translated into calibrated flow units shown on the computer's display readout.

INSTALLATION

Before installation, ensure your computer model meets your specific needs. Refer to the Specifications Section to confirm required features. The model number of your computer is displayed on the outside wall of the computer housing and also inside the computer housing on the floor of the battery holder.

If you ordered your computer electronics with a turbine body, the electronics are installed at the factory.

If you ordered your computer separately as a replacement, simply plug in the pickup coil connector and mount the computer on your turbine body with the four screws at the corners of the faceplate. Make sure the seal is fully seated before tightening the screws.

If you ordered the computer with a turbine body and an accessory module, please review and thoroughly understand all installation instructions before proceeding.

All FLOMEC turbine meters are designed to measure flow in only one direction. The direction is indicated by the arrow on the turbine outlet port. If the computer display is upside down in your installation, remove the four corner screws, turn the display 180 degrees and reinstall the screws. (See Figure 4-Screws not shown.)

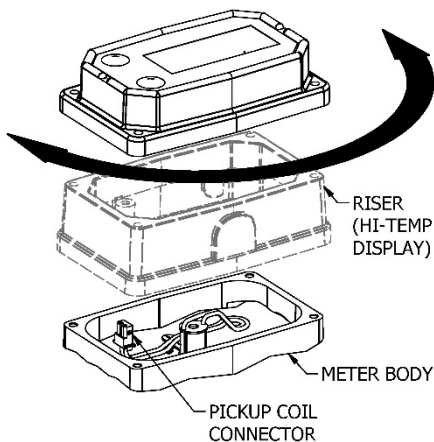

NOTE: When rotating the computer display, it is not necessary to disconnect the pickup coil connector; however, care should be taken to avoid inadvertent strain on the connector wires.

Hi-Temp Displays have a riser located between the meter body and the display. (Shown in phantom lines in Figure 4.)

Figure 4

OPERATION

COMPUTER DISPLAY

All operations are revealed on the LCD using the large 6-characters in the top row and smaller characters and symbols in the second row. These characters and symbols indicate information regarding totals, flow, calibration, units of measure and operational messages

Push button operation varies dependent upon the various modes of operation, i.e. Normal Operation mode, Field Calibration mode, and User Configuration mode. Their operation will be described in their respective sections.

ACTIVATE THE COMPUTER

When batteries are installed, the computer is on continuously and always ready to perform.

The computer is powered by field replaceable commercially available batteries. Reference the Maintenance Section for battery replacement details.

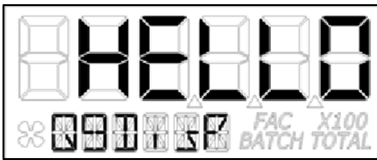

When batteries are initially installed or replaced, the initialization routine will start the LCD display blank, and then display “HELLO” on the top row and “Q9Disp” on the information row for one second. (See Figure 5)

Figure 5

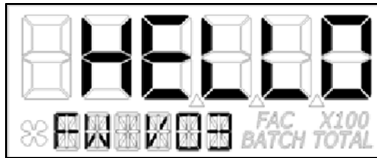

The LCD will then display “HELLO” on the top row and “FW Vxx” on the information row for one second. The Vxx will be the version of the software installed on the display. Example: “FW V03” indicates firmware version 3 installed on the display. (See Figure 6)

Figure 6

General

The computer maintains two totals; Batch total and accumulative total. The batch total can be reset to measure flow during a single use. The accumulative total provides continuous measurement and cannot be reset.

The button usage map on the next page, and the user configuration process map later in the manual, is useful for understanding where the various menus are located within the software programming and the route to get to a specific menu.

Each of these maps are followed by user instructions explaining each menu.

OPERATION

NORMAL OPERATION MODE

Button Usage Map – Normal Operation Mode

BUTTON

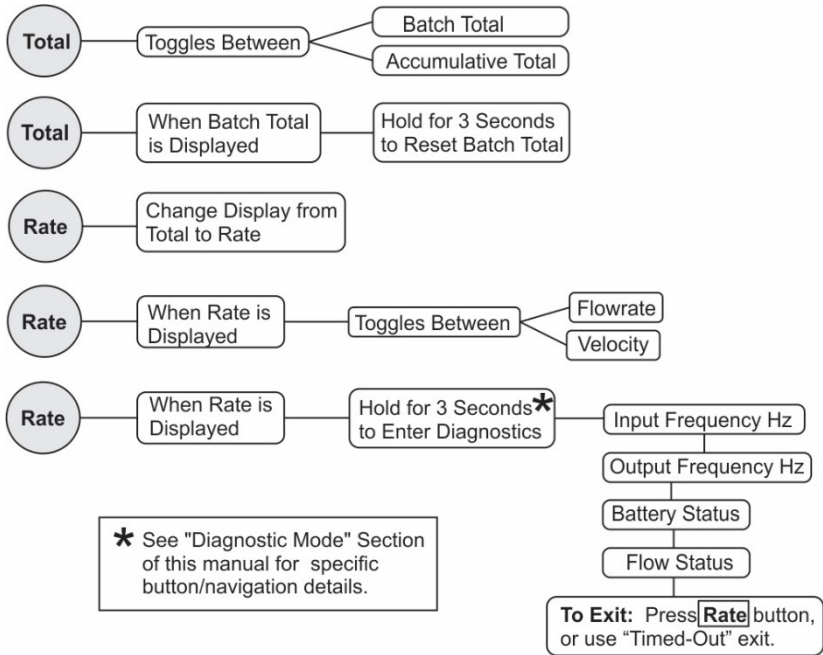

Button Operation (Normal Operation Mode)

Total Button: Change between batch total and accumulative total.

When a total is displayed, pressing the **Total** button changes the top row of large display digits between batch total and accumulative total. The information row will change to the proper units and the corresponding icons will be shown, i.e. **TOTAL** or **BATCH TOTAL**. (See Figures 7-1 and 7-2)

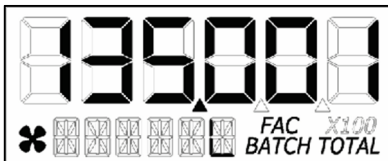

(Batch Total-Litres)

Figure 7-1



(Accumulative Total-Gallons)

Figure 7-2

OPERATION (continued)

NORMAL OPERATION MODE (continued)

Total Button: Batch total reset.

When a batch total (see Figure 8-1) is displayed, press and hold the **Total** button for 3 seconds; the software will display a three-second count down, and then reset the batch total to zero. (See Figures 8-2 thru 8-4)



Figure 8-1

NOTE: If the **Total** button is released prior to count down completion, the software returns to batch total screen. (See Figure 8-1)



Figure 8-2



Figure 8-3

NOTE: After count down completes, display will show 0.000 until user releases the **Total** button. (See Figure 8-3)

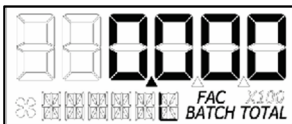

Figure 8-4

NOTE: After the **Total** button is released, the display will return to Batch Total screen and will increment the total if flow is detected. (See Figure 8-4)

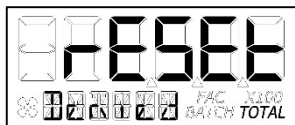

Figure 8-5

NOTE: When the accumulative total is displayed in Normal Operation Mode, it cannot be reset using the **Total** button.

OPERATION (continued)

NORMAL OPERATION MODE (continued)

Rate Button: Change display from total to rate.

When a total is displayed, pressing the **Rate** button changes the top row of large display digits from a total to a rate display. The information row will change to the proper units and the corresponding icons will also be shown, i.e. GPM, L, etc. (See Figure 9)

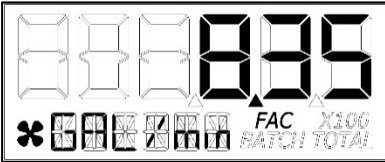
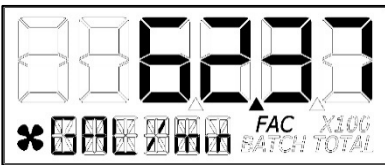

Figure 9

NOTE: To go back to a total when a rate is displayed, press the **Total** button and the display changes to the last shown total, either accumulative or batch. The information row will change to the proper unit and the corresponding icons will also be shown, i.e. TOTAL or BATCH TOTAL.

Rate Button: Change display from rate to velocity.

When a rate (see Figure 9) is displayed, pressing the **Rate** button changes the display between flow rate and velocity. The information row will change to the proper units and the corresponding icons will also be shown. (See Figures 10-1 and 10-2)



(Flowrate)

Figure 10-1

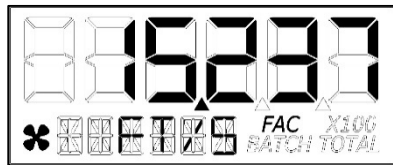

(Velocity)

Figure 10-2

Diagnostic Mode

Rate Button: Display diagnostic menu.

When a rate is being displayed, press and hold the **Rate** Button for 3 seconds; the software will display a three second diagnostic count down (see Figure 11-1), then display the first of four diagnostic screens (see Figures 11-2 thru 11-6).



Figure 11-1

NOTE: The diagnostic screens are reference information screens only. They cannot be edited.

Within the diagnostic menu: Pressing the **Total** button will advance to the next screen; pressing the **Rate** button at any time will exit the diagnostic menu. Upon exit, the display will return to the rate display.

There is a **90 second "no action" clock** running when in diagnostic mode. After 90 seconds with no button push to reset the clock, the computer will automatically exit and return to the rate display.

OPERATION (continued)

NORMAL OPERATION MODE (continued)

Diagnostic Mode (continued)

Screen 1 – Input Frequency

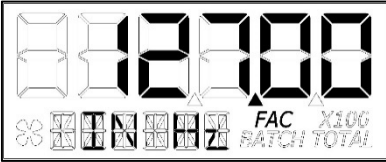

Figure 11-2

After the button is released, the software will advance and display the input frequency in Hz.

The top row is used to indicate frequency. The information row will display messages. (See Figure 11-2)

Screen 2 – Output Frequency

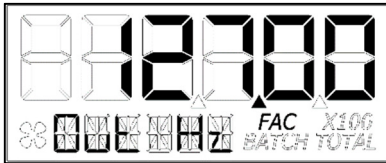

Figure 11-3

Advancing to next screen will display the output frequency in Hz.

The top row is used to indicate frequency. The information row will display messages. (See Figure 11-3)

Screen 3 – Battery Status

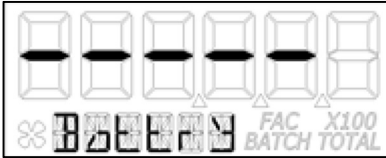

Figure 11-4

Advancing to the next screen will display the battery status.

The top row is used to indicate battery life with each dash indicating a percentage of battery life remaining. The information row will display messages. (See Figure 11-4)

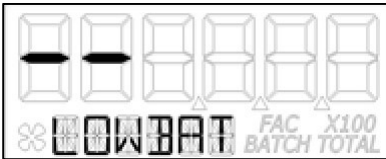

Figure 11-5

NOTE: If the battery life is sufficiently low, "LOWBAT" will be displayed in the information row. This low battery message will be displayed automatically without running a diagnostic battery check. (See Figure 11-5)

Screen 4 – Flow Status

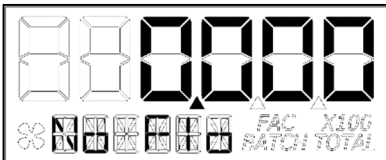

Figure 11-6

Advancing to the next screen will display the flow status.

The top row is used to indicate flow rate in the volume units programmed into the computer. The information row will display messages, i.e.: No Flo, Lo Flo, or Hi Flo. (See Figure 11-6)

OPERATION (continued)

USER CONFIGURATION MODE

General Notes for User Configuration Mode Menus

1. The term “**focus**” as used in this manual indicates an active editable item. Focused items will constantly flash ON/OFF.
2. **Advance focus:** Press the **Total** button. Advancing focus will move focus to the next editable item to the right. If already on right most item, the focus will go back to the start position in a round robin fashion. If only (1) item is editable, advancing focus will move the focus to next menu.
3. **Increment the value of editable item:** Press the **Rate** button. If editing a number, the number will increment in a round robin fashion. If editing a text option, focus will advance thru a predefined list of text depending on the active menu and item. Advancing to the next item or menu with a unit in focus will select that unit.
4. **Advance focus to next menu:** Press and hold the **Total** button and then press the **Rate** button.
5. **Retrogress focus back to previous editable item or previous menu:** Press and hold the **Rate** button and then press the **Total** button.
6. **Exit any user configuration mode menu:** Press and hold the **Total** button first and immediately press and hold the **Rate** button, holding both buttons down for 3 seconds.

NOTE: Unless an exception is noted, there is a **90 second “no action” clock** running when in user configuration mode. After 90 seconds with no button push to reset the clock, the computer will automatically exit and return to normal operating mode. There is **no automatic “save”**, all entries made up to that point would be lost.

Entering User Configuration Mode

While in normal operation mode, the user can enter the display user configuration mode by pressing and holding the **Total** and **Rate** buttons simultaneously for 3 seconds from any screen; the software will display a three second count down sequence (see Figure 12-1), then reset the display to configuration mode. (See Figure 12-2)



Figure 12-1



Figure 12-2

NOTE: After three seconds, the LCD will display “ConFig” on the top row and “Mode” on the bottom row until the user releases both of the buttons; the display will then immediately show the first menu (PIN) of the configuration process menus.

NOTE: If the user releases both or either button before the countdown completes, the display will return to normal operation mode.

OPERATION (continued)

USER CONFIGURATION MODE (continued)

General Notes for User Configuration Mode Menus

Once in configuration mode, the user can then proceed thru the configuration process menus as shown on the “configuration process map” below.

The software will retain your entries as you progress through the user configuration menus, however, there is **no automatic “save”** when exiting. Instead, you will be shown a “save” screen to enter “yes or no” to save your entries. (See Figure 13)

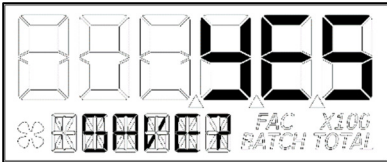
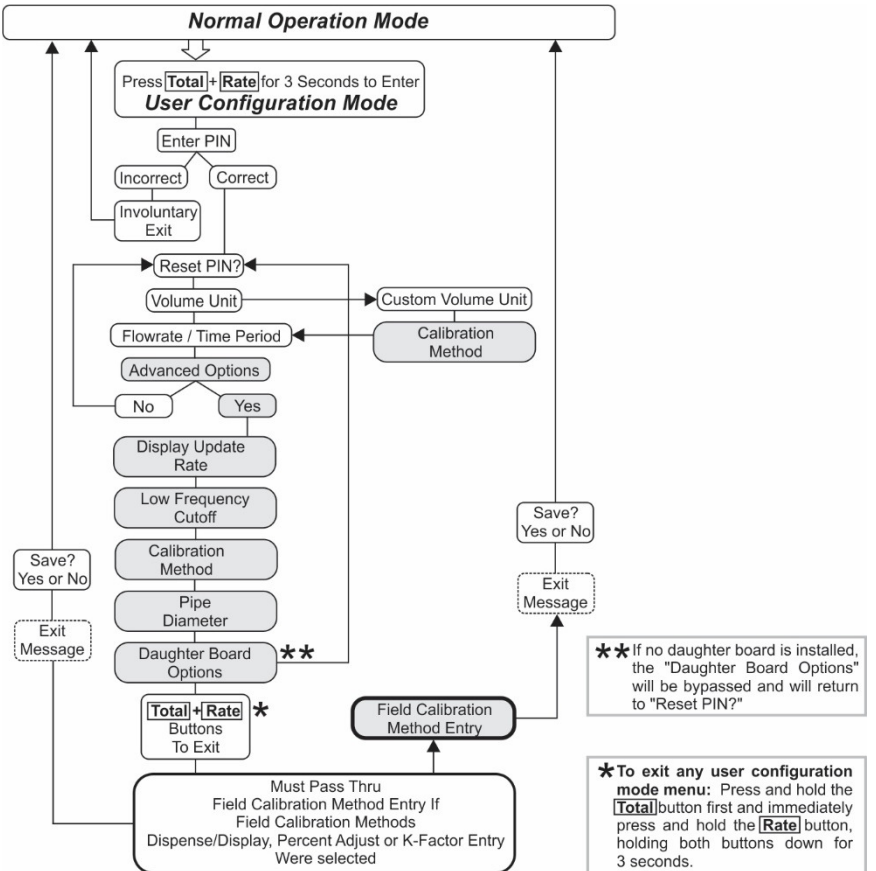

Figure 13

Use the **[Rate]** button to change between “yes” or “no”. Use the **[Total]** button to advance to the next display. Advancing to the next display will perform the “save” selection you made and return the display to normal operation mode. The last shown screen in that mode will be displayed.

NOTE: The **[Total]** button must be pressed twice (to verify the end user is “certain” of selection).

Configuration Process Map – User Configuration Mode



OPERATION (continued)

USER CONFIGURATION MODE (continued)

PIN Menu

The first menu in the configuration mode is for the user to enter a Personal Identification Number (PIN) to secure the configuration of the computer and continue with making changes.

The default user PIN is 0000. Using this default PIN will unlock the meter unless the PIN has been reset by the user.

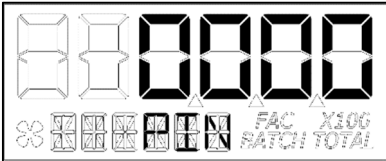

The initial user PIN entry screen will show 0000. The left most digit will be flashing ON/OFF to indicate focus if the user wants to change the PIN. (See Figure 14-1)

Figure 14-1

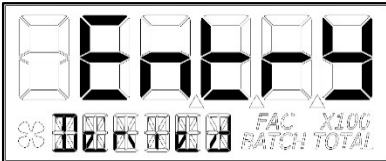

If the entered PIN was incorrect, the screen momentarily displays “Entry Denied” (See Figure 14-2) then returns automatically to normal operation display.

Figure 14-2

NOTE: Using the user default PIN, or the user specific PIN (if previously reset), and advancing focus to the next menu, the software will compare the entered PIN with the PIN stored in the computer. If a match is found, the next menu will be shown allowing the user to reset the PIN if desired.

Reset PIN Menu

If the PIN was entered correctly, the next menu will be displayed and allow reset of the PIN if desired. (See Figure 15-1)



Figure 15-1



Figure 15-2

The “N” will be in focus (flashing). To decline resetting the PIN, advance focus to next menu. To reset the PIN, increment the “N” to “Y” (see figure 15-2) and advance focus to next screen. (See Figure 16)

OPERATION (continued)

USER CONFIGURATION MODE (continued)

Reset PIN Menu (continued)

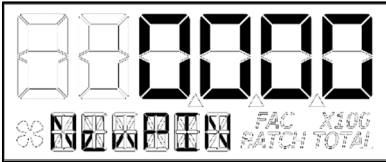

If “Y” was selected, the previous PIN will be shown. The left most digit of PIN is in focus. Increment the value of each digit as desired as you advance focus through the digits.

After reset of the PIN, advance focus to next menu.

Figure 16

Volume Unit Menu

On this menu the user will be allowed to enter their volume unit of measure from a list of options. (See Figure 17).

Volume Unit	Abbreviation	Volume Unit	Abbreviation
Gallon	GAL	Litre	L
Imperial Gallon	IGAL	Millilitre	mL
Custom	Set by user	Cubic Metre	m3
Acre-Foot	Ac--Ft	Cubic Centimetre	cm3
Quart	Qt	Cubic Foot	FT3
Ounce	OZ	Barrel	bbl

Figure 17



On the volume unit menu (see Figure 18) the bottom row of characters will be in focus to indicate they are editable.

Advancing to the next menu with a unit in focus will select that unit of measure.

Figure 18

Changing between different volume units will not corrupt the Total's contents. For example, in GAL (gallon) mode, the computer totalizes 10.000 gallons, if the user changes to L (litre) mode, the display will read 37.854 litres (the same volume, different unit).

Custom Volume Unit Label Menu

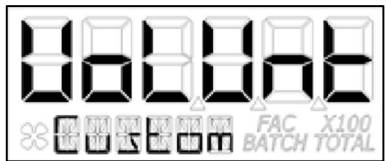

The software also allows the user to create their own “Custom” volume unit (see Figure 19). Advancing to the next menu with the “Custom” volume unit in focus will shunt the user to a new menu (see below) that will allow the user to create a new label, or reuse one already stored in computer memory.

Figure 19

OPERATION (continued)

USER CONFIGURATION MODE (continued)

Custom Volume Unit Label Menu (continued)

If the computer is new or has no previous custom volume unit label stored in memory, the screen will appear with three dashes. (See Figure 20)

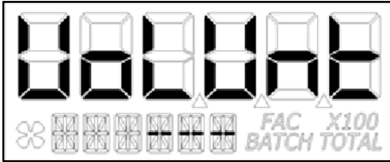

Figure 20

The left most of the dashes will be in focus and the user can select a letter from the list of upper case letters. An empty space will be shown on the menu screen as an underscore “_” during creation, but the underscore will not show when displaying the unit label in operation.

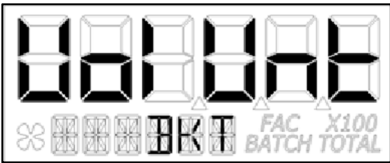

Figure 21

If the user has previously entered a custom volume unit label, it will be read from computer memory and the unit label will be displayed (see Figure 21) with the left most character in focus. The label can then be changed if desired.

NOTE: Once the custom volume unit label is created, the user will be required to enter a calibration method for the custom volume unit created. Therefore, upon advancing focus to next menu, the user will be shunted to the calibration method menu to select a method of calibrating their custom volume unit.

NOTE: The calibration method section that defines the methods of calibration can be found later in this manual.

After selecting the calibration method, advance focus to the next menu that will be flow rate/ time period menu.

NOTE: The computer will remember your calibration method selection. If you selected field calibration methods dispense display, percent adjust, or K-factor method, you will be given the opportunity to configure that method at the point you decide to exit the user configuration mode. At that point, the software will automatically shunt you to the field calibration method entry menu.

The field calibration method entry section that defines the field calibration procedure of the selected method can be found later in this manual.

NOTE: The factory calibration stored in the unit will never be lost.

OPERATION (continued)

USER CONFIGURATION MODE (continued)

Flow Rate / Time Period Menu

This menu is used to choose the period of time over which the flow rate is calculated. The options for this menu are: per day, hour, minute, or second. (See Figure 22-1)

Time Base	Abbreviation
Day	d
Hour	h
Minute	min
Second	s

Figure 22-1



Figure 22-2

When the screen is displayed, the software will show the current selected volume unit and time period (see Figure 22-2) and will display both in the bottom row with a back-slash between them. The time period unit will be in focus and can be edited by the user.

After advancing to the next configuration menu, the time period will be temporarily stored (see Figure 13 and its description for permanently saving) to computer memory.

OPERATION (continued)

USER CONFIGURATION MODE (Advanced Options)

Advanced Options Menu

This menu is used to access the Advanced Options. The **[Rate]** button is used to change between NO and YES selections. The **[Total]** button is used to select either NO or YES for the Advanced Options menu.

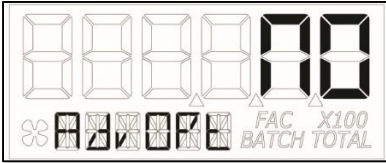

Select NO to return to Normal User Configuration menu (See Figure 23-1).

Figure 23-1

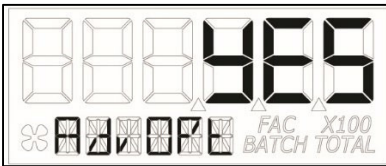

Select YES to enter into the Advanced Options menu (See Figure 23-2).

Figure 23-2

Display Update Rate Menu

This menu allows a validated user to change the update rate of the display for flow rate, velocity, batch total, and accumulative total.

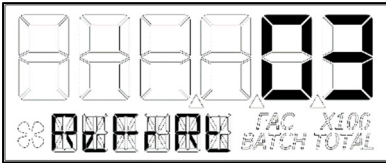

The range of this menu is from 1 to 60 seconds. Although the computer is maintaining constant calculations, the rate that the new information is displayed is controlled by this menu. (See Figure 24)

NOTE: "00" may be selected, but that value will represent "01" (1 second).

Figure 24

Low Frequency Cutoff Menu

This menu allows a validated user to enter a minimum allowed pulse input frequency to filter out any low frequency input pulses which can be generated when the meter is subject to mechanical vibrations. These vibrations could cause the totalizer to add "phantom" volume to the display totalization values. (See Figure 25)

The software will read the minimum input frequency from the computer and display it on the top row with the left most digit in focus. Increment range is from 0 Hz to 255 Hz.

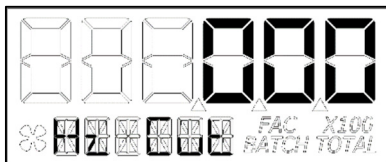

If 0 is set, the software will disable the input frequency filtering algorithm.

When advancing to the next menu, the software will temporarily store (see Figure 13 and its description for permanently saving) the selected value to the computer.

Figure 25

OPERATION (continued)

USER CONFIGURATION MODE (Advanced Options) (continued)

Calibration Method Selection Menu

This menu is used to define which calibration method will be used in normal operation. The calibration method the user previously selected (if any) will be shown on the display first. The bottom row of characters will be in focus indicating that the user can change the calibration method. Use the **Rate** button to move through the various calibration method options, and use the **Total** button to make "Calibration Method" selection/advance to next menu option.

Factory Calibration: All units are configured with a "factory" calibration. This factory calibration (FAC icon displayed below 6-digit display) is permanently programmed into the computer and is not user adjustable.

NOTE: The factory calibration stored in the unit will never be lost

Factory calibration is the typical use method (see Figure 26-1). Prior to shipping from the factory, the display will be configured and calibrated to the meter body on which it is installed (or going to be installed).

When the user selects this option the FAC icon will be "ON" to indicate that the display is using its factory calibration table. This method does not support field calibration.

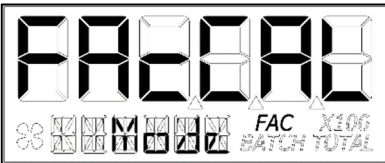

Figure 26-1

Field Calibration: If one of the following calibration methods is selected (dispense display, percent adjust, or K-factor entry), the user will be routed through the field calibration method entry menu, before saving configuration options, to make specific entries for the selection.



Figure 26-2

Dispense/Display is a field calibration method by which the user will dispense a known volume of fluid and the software will keep track of the pulse count during the dispense operation. The user will then enter the known volume into the display and the software will calculate a K-factor for the volume dispensed. (See Figure 26-2)

Percent Adjust method is a field calibration method by which the user will enter a percentage amount to adjust K-factor values in the factory programmed K-factor table. Once the percentage is input by the user, the software will apply this percentage adjustment to all calculated and displayed values. (See Figure 26-3)

This method is good for users who simply want to adjust their meter by a percentage amount.



Figure 26-3

OPERATION (continued)

USER CONFIGURATION MODE (Advanced Options) (continued)

Calibration Method Selection Menu (continued)

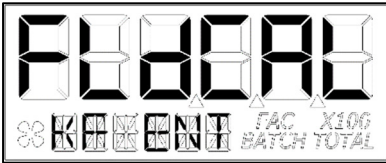

Figure 26-4

K-Factor Entry method (see Figure 26-4) is a field calibration method by which the user can input either a single point or multipoint calibration table.

From 1 to 5 unique K-factor and frequency values can be entered and will be stored in the custom K-factor table in the computer.

Inner Pipe Diameter Menu

This menu is to allow the user to enter a pipe inner diameter (ID) which will allow the display to calculate and display the fluid velocity thru the meter. The pipe dimension unit can be selected as either inches (IN) or millimetres (mm) as preferred by user (see Figure 27-1).

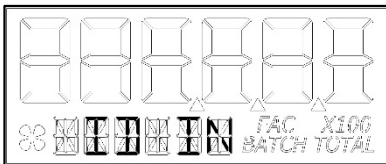

Figure 27-1

On this screen, the software will read the pipe ID measurement unit label from the computer and display it on the bottom row as either English (IN) or metric (mm) units. The unit label (IN or mm) will have the focus to indicate that it can be changed.

Pressing the **Rate** button will change between inches (IN) and millimetres (mm). Pressing the **Total** button will temporarily store (see Figure 13 and its description for permanently saving) the selection and allow the user to edit the pipe inner diameter value.

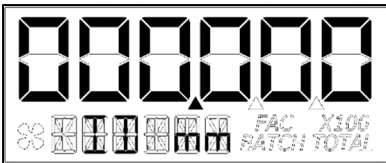

Figure 27-2

The software will also read the pipe ID numeric value including decimal point from the computer. The left most decimal point is in focus to indicate it can be changed (see Figure 27-2).

Pressing the **Rate** button moves the decimal point focus to the next decimal point to the right until reaching the end, then, turns off all three. An additional button press will cycle the focus back to the left most decimal point in a round robin fashion. When the decimal point is in the correct position, pressing the **Total** button will lock its location. The screen then advances focus to the left most numeric value digit to allow the user to edit the pipe ID value.

Pipe ID values can be from 0.001 to 999999. The inner pipe diameter entries will be used in the fluid velocity rate calculation during normal operation.

Pressing the **Rate** button will increment the digit in focus. Pressing the **Total** button will advance focus to the next digit. To advance focus to the next menu, press and hold the **Total** button and then press the **Rate** button (see Configuration Process Map).

NOTE: Upon entering the next menu, the software will temporarily store the pipe ID entries in the computer.

NOTE: Failure to save your entries on the “save” screen will cause the entries to be discarded.

OPERATION (continued)

USER CONFIGURATION MODE (Advanced Options) (continued)

DAUGHTER BOARD MODULES

Output K-Factor Menu

(Requires Pulse Access or 4-20mA Daughter Board Module)

The scaled pulse output K-factor menu allows the user to enter a K-factor for the pulse output of the meter or advance focus to the next menu.

The software will read the pulse output K-factor from the computer and display it on the top row. The **Total** and **Rate** button presses for this menu function the same as the button presses for the Inner Pipe Diameter Menu shown on the previous page. (See Figure 28–The zero values shown represent an unscaled Pulse Output.)

NOTE: Pulse output values cannot exceed pulse input values. Pulse output can only be scaled down.

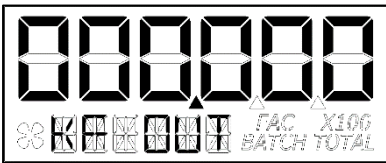

Figure 28

When advancing focus to the next menu the software will temporarily store (see Figure 13 and its description for permanently saving) the Scaled Pulse K- factor to the computer.

4-20mA Menu (Requires 4-20mA Daughter Board Module)

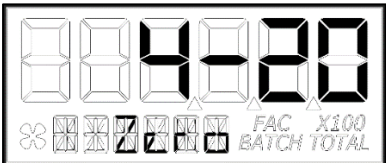

Figure 29-1

“Zero” Setting: This figure will flash for 1 second before allowing the user to change the 4mA or “zero” setting (see Figure 29-1). This setting will already be configured for the minimum flowrate of the meter this Q9 was attached to, when shipped from the factory.

The **Total** and **Rate** button presses for this menu function the same as the button presses for the Inner Pipe Diameter Menu shown on the previous page.

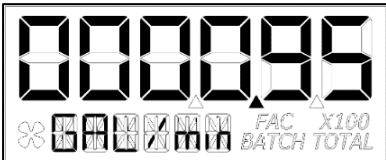

Figure 29-2

NOTE: Figure 29-2 shows the display when changing “zero” or 4mA Flowrate Settings.

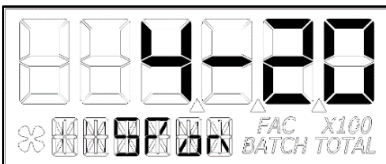

Figure 29-3

“Span” Setting: This figure will flash for 1 second before allowing the user to change the 20mA or “span” setting (see Figure 29-3). This setting will already be configured for the maximum flowrate of the meter this Q9 was attached to when shipped from the factory.

The **Total** and **Rate** button presses for this menu function the same as the button presses for the Inner Pipe Diameter Menu shown on the previous page.

OPERATION (continued)

USER CONFIGURATION MODE (Advanced Options) (continued)

DAUGHTER BOARD MODULES (continued)

4-20mA Menu (Requires 4-20mA Daughter Board Module) (continued)

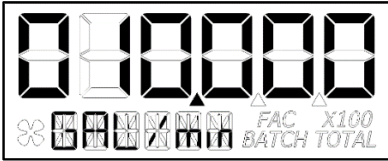

NOTE: Figure 29-4 shows the display when changing "span" or 20mA Flowrate Settings.

Figure 29-4

USER CONFIGURATION MODE (Field Calibration Mode)

Field Calibration Method

General

The field calibration method may be set by the user, and can be changed or modified at any time using a field calibration method described in this section. Totals or flowrate derived from the field calibration are being invoked when the (FAC) icon is no longer visible below the 6-digit display.

Factory calibration settings are programmed into each computer during manufacturing, using Stoddard test solvent at 70° F (21° C) for meters up to 1 inch. Meters 1-1/2 inch and larger are factory calibrated using water at 70° F (21° C).

Settings are correct for light liquids such as water, gasoline or diesel. Readings using the factory calibration (FAC) may not be accurate in some situations, for example, "heavy" liquids such as motor oil, under extreme temperature conditions, non-standard plumbing configurations or with fluids other than those mentioned above.

For improved accuracy under such conditions, the computer allows for field calibration, that is, user entry of custom calibration parameters. A "single point" field calibration curve may yield acceptable accuracy when used in a non-standard application; however, the computer is capable of programming a "five point" field calibration curve.

NOTE: If the calibration method is changed when in user configuration mode, i.e., not using the default factory calibration (FAC), the programming will allow the user to adjust the user programmable calibration table for the calibration method selected. This is done by shunting the user to the field calibration method entry menu specific to that calibration method upon exit from the user configuration mode.

Verify Accuracy before Beginning Field Calibration

For the most accurate results, dispense at a flowrate which best simulates your actual operating conditions. Avoid "dribbling" more fluid or repeatedly starting and stopping the flow. This can result in less accurate calibrations. Make sure you meet the meter's minimum flowrate requirements.

The use of a uniformly dependable, accurate calibration container is recommended for the most accurate results. For best results, the meter should be installed and purged of air before field calibration.

Due to high flowrates on meters 2 inch and larger, it is strongly recommended that field calibration be completed with a combination of volume and weight determined with fine resolution scales.

OPERATION (continued)

USER CONFIGURATION MODE (Field Calibration Mode) (continued)

Field Calibration Method Entry

At the beginning of the calibration method entry menu, the software will allow the user to start the calibration process or to exit back to normal operation. (See Figures 30-1 & 30-2)

The bottom row of characters will be in focus to indicate that the user can select between either “Start” or “Exit” by advancing focus. The **Rate** button changes between START & EXIT while the **Total** button makes the actual selection.

NOTE: The **Total** button must be pressed twice (to verify the end user is “certain” of selection).

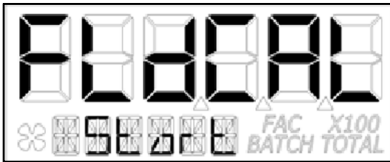

Figure 30-1

If “Start” is in focus when advancing to the next menu, the software will automatically advance to the calibration menu for the calibration method the user previously selected.

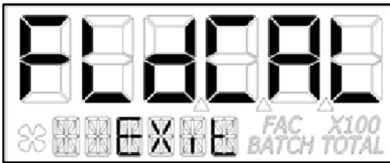

Figure 30-2

If “Exit” is in focus when advancing to the next menu, the software will display a “save” screen (see Figure 13) to enter “yes or no” to save your entries.

Dispense Display Method

Dispense/Display is a field calibration method by which the user will dispense a known volume of fluid and the software will keep track of the pulse count during the dispense operation. The user will then enter the known volume into the display and the software will calculate a K-factor for the volume dispensed. (See Figure 31-1)

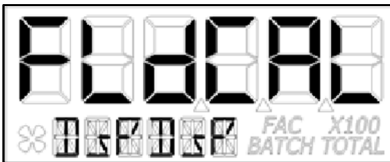

Figure 31-1

The software will allow the user to dispense a known volume in order to create a custom K-factor. This will not over write the existing factory calibration table.

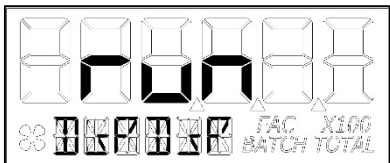

Figure 31-2

The first screen in this calibration method will show “run” indicating that the computer is waiting for flow to start. (See Figure 31-2)

NOTE: Pressing any single button while on this screen will not have any effect. Pressing and holding the **Total** button first and immediately pressing and holding the **Rate** button, holding both buttons down for 3 seconds, will allow the user to exit the calibration mode.

OPERATION (continued)

USER CONFIGURATION MODE (Field Calibration Mode) (continued)

Dispense Display Method (continued)

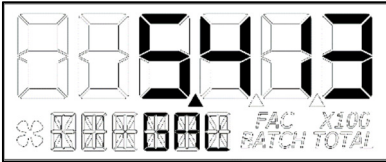

Figure 31-3

Begin dispensing into a container of known accurate volume. As soon as pulses are detected by the software, the screen will change to display the volume being dispensed on the top row and the volume unit on the bottom row. (See Figure 31-3)

NOTE: The user is permitted approximately 10 minutes to dispense fluid into the container. Dispensing fluid longer than 10 minutes will prompt a configuration mode exit, and any configuration mode edits/changes the user made will **NOT BE SAVED**.

When the user is finished with the run, press and hold the **Total** button until the left most digit begins to flash indicating it is in focus, then release the **Total** button.

Pressing the **Rate** button will increment the digit in focus. Pressing the **Total** button will advance focus to the next digit.

To advance focus to the next menu, press and hold the **Total** button and then press the **Rate** button.

NOTE: Advancing focus to the next menu will lock in the entered volume.

The software will then calculate the K-factor for the volume entered based on the pulse count for the run and the volume entered. The average frequency and the K-factor will be entered into the custom user K-factor table for "run".

Exit Dispense Display Method



Figure 32

NOTE: "FidCAL" will then be displayed on the top row and "Exit" on the bottom row (see Figure 32). The software will temporarily store the sorted table of frequencies and K-factors, then display the "Save" screen. (See Figure 13)

NOTE: Failure to save your entries on the "save" screen will cause the entries to be discarded.

OPERATION (continued)

USER CONFIGURATION MODE (Field Calibration Mode) (continued)

Percent Adjust Method (Correction Factor)

Percent adjust method is a field calibration method by which the user will enter a percentage amount to adjust K-factor values in the factory programmed K-factor table. Once the percentage is input by the user, the software will apply this percentage adjustment to all calculated and displayed values. (See Figure 33-1)

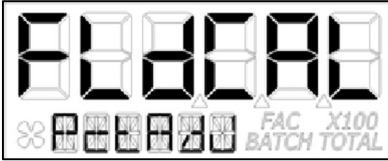

This will not over write the existing factory calibration table, instead, it applies a calculation to the existing values for use by the computer.

This method is good for users who simply want to adjust their meter by a percentage amount.

Figure 33-1

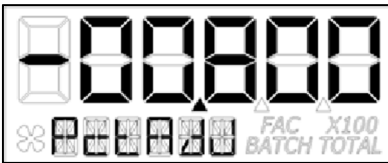

The top row left most character will be in focus to indicate the user can change the value. The left most character is the sign of the value. The decimal point is not adjustable. The range for the values are: -99.999% to +99.999%. The software will display the user applied percent adjustment on the top row. (See Figure 33-2)

Figure 33-2

Press the **Rate** button to change between (dash "-") and (underscore "_"). A dash indicates a negative value. An underscore indicates a positive value. Press the **Total** button to select/lock dash "-" (*negative value*) or underscore "_" (*positive value*). The focus will then advance to the left most digit.

NOTE: A selected positive value will show no sign while a negative value will show a solid dash.

Once the left most digit is in focus, pressing the **Rate** button will increment the digit in focus. Pressing the **Total** button will advance the focus to the next digit.

When all digits are entered correctly, exit by pressing and holding the **Total** button and then pressing the **Rate** button.

NOTE: "FldCAL" will then be displayed on the top row and "Exit" on the bottom row (see Figure 32). The software will temporarily store the adjusted percentage correction, then display the "Save" screen. (See Figure 13)

NOTE: Failure to save your entries on the "save" screen will cause the entries to be discarded.

OPERATION (continued)

USER CONFIGURATION MODE (Field Calibration Mode) (continued)

K-Factor Entry Method - Frequency

K-factor entry method (see Figure 34-1) is a field calibration method by which the user can input either a single point or multipoint calibration table.

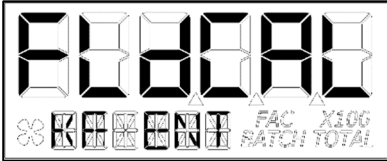

Figure 34-1

From 1 to 5 unique K-factor and frequency values can be entered and will be stored in the custom K-factor table in the computer. This will not overwrite the existing factory calibration table.

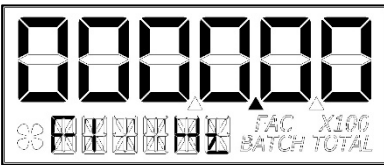

Figure 34-2

The software will read the existing K-factor table from the computer and will display the first frequency on the top row (see Figure 34-2) with the left most character in focus to indicate the user can change the value. Minimum frequency value allowed is 0.25 Hz and the maximum allowable frequency value is 3000.00 Hz. The decimal point for the frequency value is fixed.

Pressing the **Rate** button will increment the digit in focus. Pressing the **Total** button will advance the focus to the next digit.

Once the correct frequency is entered, pressing and holding the **Total** button, then pressing the **Rate** Button will advance to the next screen. (See Figure 34-3)

NOTE: Entering all zeros (see Figure 34-2) will store the value as a minimum frequency (0.25 Hz).

OPERATION (continued)

USER CONFIGURATION MODE (Field Calibration Mode) (continued)

K-Factor Entry Method – K-Factor Value

The software will read the existing K-factor table from the computer and will display the first K-factor on the top row. The bottom row displays the K-factor table entry position (1 thru 5) for the volume unit shown. (See Figure 34-3.)

Pressing the **Rate** button moves the decimal point focus to the next decimal point to the right until reaching the end, then, turns off all three. An additional button press will cycle the focus back to the left most decimal point in a round robin fashion. When the decimal point is in the correct position, pressing the **Total** button will lock its location. The screen then advances focus to the left most numeric value digit to allow the user to edit the K-Factor value.

Pressing the **Rate** button will increment the digit in focus. Pressing the **Total** button will move the focus to the next digit. Pressing and holding the **Total** button, then pressing the **Rate** button will advance to the next screen (see Figures 34-4 and 34-5).

NOTE: User input K-factor entry values will disable the (FAC) icon. The K-factor range is 0.001 to 999999.

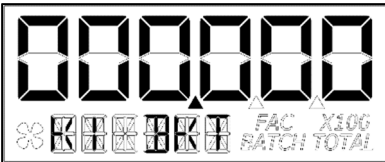

Figure 34-3

After completing the first table entry of frequency and K-factor, the display will ask the user if there are additional points to enter. The **Rate** button changes between Y (Yes) & N (No) while the **Total** button makes the actual selection (See Figures 34-4 & 34-5)

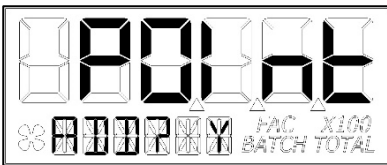

Figure 34-4

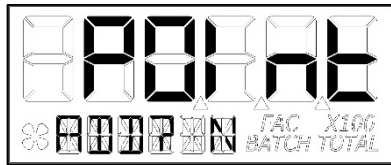

Figure 34-5

If the user chooses YES, the previous screens will repeat for Frequencies 2 – 5 and K-factors 2 – 5.

NOTE: If the table stops short of 5 points, then only the points entered will be used to define the calibration curve.

If the user chooses NO (or after the fifth table entry of frequency and K-factor) the software will show the FLdCAL Exit screen (see Figure 32) for one second, and will then exit field calibration mode. The software will temporarily store the K-factor table values in the computer, and then display the “Save” screen (see Figure 13).

NOTE: Failure to save your entries on the “save” screen will cause the entries to be discarded.

TROUBLESHOOTING

Symptom	Probable Cause	Corrective Action
A. INACCURATE TOTALS / FLOWRATE.	<ol style="list-style-type: none"> 1. Field Calibration not performed properly. 2. Factory Calibration not suitable for liquid being measured. 3. Meter operated below minimum flowrate. 4. Meter partially clogged with dried liquid. 5. Turbine bearings partially clogged with dried liquid. 6. Sealant material wrapped around meter rotor. 7. Meter installed too close to fittings. 8. Meter installed too close to motors or electrically "noisy" environment. 	<p>Field calibrate again or select Factory Calibration.</p> <p>Perform a Field Calibration according to Field Calibration Section.</p> <p>Increase flowrate.</p> <p>Remove meter. Clean carefully. Make sure rotor spins freely.</p> <p>Remove meter. Clean carefully. Make sure rotor spins freely.</p> <p>If applicable, remove rotor. Make sure rotor spins freely.</p> <p>Install correctly.</p> <p>Install correctly.</p>
B. BUTTON NOT WORKING.	<ol style="list-style-type: none"> 1. Button plunger not fully pressed. 2. Button only operates upon release. 3. Assembly issue. 4. Configuration issue. 	<p>Ensure finger covers entire button.</p> <p>Release button to see display change.</p> <p>Contact the factory.</p> <p>Contact the factory.</p>
C. "BA0.000" IS DISPLAYED.	<ol style="list-style-type: none"> 1. Configuration issue. 	<ol style="list-style-type: none"> a. Reset Batch and Accumulative Totals. b. Performing a Field Calibration may allow desired performance. c. Contact the factory.
D. WEIRD CHARACTERS ON SCREEN.	<ol style="list-style-type: none"> 1. Assembly issue. 2. Bad LCD. 	<p>Contact the factory.</p> <p>Contact the factory.</p>
E. DISPLAY IS FADED OR BLANK.	<ol style="list-style-type: none"> 1. Batteries weak, dead, or not connected. 2. Ambient temperature is too cold. 3. Computer defective. 	<p>Remove display. Check and replace batteries.</p> <p>Place bare hand or warmer on display for temporary readability.</p> <p>Contact the factory.</p>

TROUBLESHOOTING (continued)

Symptom	Probable Cause	Corrective Action
F. ENTIRE SCREEN "BLUISH".	1. Ambient / fluid temperature is reaching upper heat limits.	If readable, display is fine. If a nuisance, consider Remote Display kit options.
G. NO FLOW ON SCREEN WHEN FLUID IS MOVING IN PIPE.	1. Field Calibration not performed correctly. 2. Rotor stuck or damaged. 3. Sealant material wrapped around rotor. 4. Computer defective.	Field calibrate again or select Factory Calibration. Remove meter. Make sure rotor spins freely. Remove meter. Make sure rotor spins freely. Contact the factory.
H. EXCESSIVE FLOW ON SCREEN WHEN FLUID IS NOT MOVING IN PIPE.	1. Electro-Magnetic Interference (EMI) – Too close to motor or other electrically "noisy" equipment.	Move installation point of meter away from EMI sources.
I. PROBLEMS GETTING INTO FIELD CALIBRATION MODE.	1. Wrong button sequence.	Proceed with calibration using Field Calibration Section instructions that are included in this manual.
J. PROBLEMS NAVIGATING "DIAGNOSTIC MODE", "CONFIGURATION MODE", OR "NORMAL OPERATION MODE".	1. See this owner's manual Table of Contents for page number information for each specific "Mode" Section.	See specific "Mode" Section that is included in this owner's manual.
K. DAUGHTER BOARD MODULE OUTPUT INACCURATE.	1. See specific Daughter Board Module owner's manual.	See specific Daughter Board Module owner's manual.

MAINTENANCE

Batteries

The computer electronics are powered by alkaline batteries. Removing the batteries before storing the meter will extend battery life since the computer is always on (either standby or active) when the batteries are installed.

If the meter's readout should become dim, blank or the low battery message appears (see below), the batteries should be replaced.

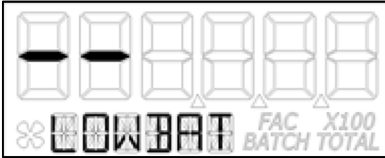

NOTE: If the battery life is sufficiently low, "LOWBAT" will be displayed in the message area on the bottom row of characters. This low battery message will be displayed automatically without running a diagnostic battery check.

Battery Replacement Information

The computer is shipped with (2) alkaline AAA size batteries (1.5-volts each) installed.

Battery replacements are readily available as an off-the-shelf item. To maintain the FLOMEC® warranty, the batteries listed below are approved for use.

Alkaline (AAA size, 1.5-volts each)
 Energizer, Alkaline, E92 or En92
 Duracell, Alkaline, Mn2400

Lithium (AAA size, 1.5-volts each)
 Energizer, Lithium, L92

Do not mix brands or technologies. Do not mix old and new batteries. Do not use rechargeable batteries.

When batteries are disconnected or fail, the computer memory will retain the batch total, accumulative total, factory calibration curve, and field calibration curve indefinitely.

It is strongly recommended that battery checks and terminal cleaning be a part of a routine maintenance schedule. Battery terminals should be cleaned annually. Batteries can be replaced without removing the meter from the piping system.

Replace Batteries

1. Remove the (4) corner screws attaching the computer electronics to the meter and lift the computer electronics from the meter.
2. Remove the batteries.
3. Check the battery terminals and remove any corrosion.
4. Install the new batteries and make sure the positive posts are positioned correctly. When the batteries are installed correctly, the computer powers on automatically and the display will show information.
5. Make sure the seal is fully seated before placing the computer electronics back on the turbine. Tighten the (4) screws previously removed.
6. Do not clean exterior of computer assembly with Isopropyl Alcohol.

PARTS

The factory, when provided with model number and serial number, can replace your entire computer electronics assembly. Order replacement kits, parts, and accessories with the part numbers shown below.

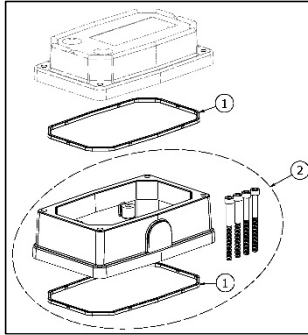

Item No.	Part No.	Description	No. Reqd.
1	901002-52	Seal (Display) Seal (Hi-Temp Riser, If Installed)	1 1
2	125527-01	Kit, Q9 Hi-Temp Riser (G2S Meters Only) <i>Includes: Riser, Seal, (4) screws</i>	1

SERVICE

For warranty consideration, parts, or other service information, please contact your local distributor. If you need further assistance, contact the GPI Customer Service Department in Wichita, Kansas, during normal business hours.

A toll free number is provided for your convenience.

1-888-996-3837

To obtain prompt, efficient service, always be prepared with the following information:

- The model number of your computer.
(Printed on label located on bottom of one of the battery holders.)
- The serial number or manufacturing date code of your computer.
(Printed on label located on bottom of one of the battery holders.)
- Part descriptions and numbers.

For warranty work, always be prepared with your original sales slip or other evidence of purchase date.

IMPORTANT: Please contact GPI before returning any parts. It may be possible to diagnose the trouble and identify needed parts in a telephone call.



FLOMEC® TWO-YEAR LIMITED WARRANTY

Great Plains Industries, Inc. 5252 E. 36th Street North, Wichita, KS USA 67220-3205, hereby provides a limited warranty against defects in material and workmanship on all products manufactured by Great Plains Industries, Inc. This product includes a 2-year warranty. Manufacturer’s sole obligation under the foregoing warranties will be limited to either, at Manufacturer’s option, replacing or repairing defective Goods (subject to limitations hereinafter provided) or refunding the purchase price for such Goods theretofore paid by the Buyer, and Buyer’s exclusive remedy for breach of any such warranties will be enforcement of such obligations of Manufacturer. The warranty shall extend to the purchaser of this product and to any person to whom such product is transferred during the warranty period.

The warranty period shall begin on the date of manufacture or on the date of purchase with an original sales receipt. This warranty shall not apply if:

- A. the product has been altered or modified outside the warrantor’s duly appointed representative;
- B. the product has been subjected to neglect, misuse, abuse or damage or has been installed or operated other than in accordance with the manufacturer’s operating instructions.

To make a claim against this warranty, or for technical assistance or repair, contact your FLOMEC distributor or contact FLOMEC at one of the locations below.

In North or South America contact

Great Plains Industries, Inc.
5252 East 36th St. North
Wichita, KS 67220-3205
USA

888-996-3837

www.flomecmeters.com
(North America)

Outside North or South America contact

GPI Australia
(Trimec Industries Pty. Ltd.)
12/7-11 Parraweena Road
Caringbah NSW 2229
Australia

+61 02 9540 4433

www.flomec.com.au

The company will step you through a product troubleshooting process to determine appropriate corrective actions.

GREAT PLAINS INDUSTRIES, INC., EXCLUDES LIABILITY UNDER THIS WARRANTY FOR DIRECT, INDIRECT, INCIDENTAL AND CONSEQUENTIAL DAMAGES INCURRED IN THE USE OR LOSS OF USE OF THE PRODUCT WARRANTED HEREUNDER.

The company herewith expressly disclaims any warranty of merchantability or fitness for any particular purpose other than for which it was designed.

This warranty gives you specific rights and you may also have other rights which vary from U.S. state to U.S. state.

NOTE: In compliance with MAGNUSON MOSS CONSUMER WARRANTY ACT – Part 702 (governs the resale availability of the warranty terms).

Wichita / Sydney



© 2021 Great Plains Industries, Inc., All Rights Reserved.
Great Plains Industries, Inc. / 888-996-3837 / flomecmeters.com