

Type 2610, 2612, 2620

2/2-way valve
2/2-Wege-Ventil
Vanne 2/2 voies

Operating Instructions

Bedienungsanleitung
Manuel d'utilisation

MAN 1000303217 DE Version: -Status: RL (released | freigegeben) printed: 19.05.2026



Type 2610

1 OPERATING INSTRUCTIONS

The operating instructions contain important information.

- ▶ Read the operating instructions carefully and follow the safety instructions in particular, and also observe the operating conditions.
- ▶ Operating instructions must be available to each user.
- ▶ The liability and warranty for the Type 2610, Type 2612 and Type 2620 are void if the operating instructions are not followed.

1.1 Symbols

- ▶ Designates an instruction to prevent risks.
- Designates a procedure which you must carry out.

Warning of injuries:



DANGER!

Imminent danger! Serious or fatal injuries.



WARNING!

Potential danger! Serious or fatal injuries.



CAUTION!

Danger! Minor or moderately severe injuries.

Warns of damage to property:

NOTE!

2 INTENDED USE

Incorrect use of the solenoid valve Type 2610, the piston actuated valve Type 2612 and the diaphragm actuated valve Type 2620 can be dangerous to people, nearby equipment and the environment.

The device is designed for blocking, dosing, filling and venting gaseous and liquid media.

- ▶ Use according to the permitted data, operating conditions and conditions of use specified in the contract documents and operating instructions.
- ▶ Correct transportation, correct storage and installation and careful use and maintenance are essential for reliable and problem-free operation.
- ▶ Use the device only as intended.
- ▶ Check media resistance.

2.1 Definition of term

In these operating instructions, the term “device” always refers to the solenoid valve Type 2610, the piston actuated valve Type 2612 and the diaphragm actuated valve Type 2620.

2.2 Insulation

Type 2610, 2620:

The device must not be insulated more than 2 cm from the edge of the body upwards to the actuator.

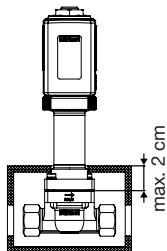

3 BASIC SAFETY INSTRUCTIONS

These safety instructions do not make allowance for any contingencies and events which may arise during installation, operation and maintenance.



Risk of injury from high pressure.

- ▶ Before loosening the lines and valves, turn off the pressure and vent the lines.

Risk of electric shock.

- ▶ Before reaching into the system, switch off the power supply and secure to prevent reactivation. Observe applicable accident prevention and safety regulations for electrical equipment.

Risk of burns or risk of fire.

During continuous operation or hot media the surface of the device may become hot.

- ▶ Keep the device away from highly flammable substances and media and do not touch the device with bare hands.
- ▶ Do not obstruct the heat release required for operation.

Danger due to high and low temperatures.

The device may become extremely cold or hot depending on the temperature of the media.

- ▶ Keep away from flammable and cold-sensitive substances and do not touch with bare hands.

Risk of injury from hot, cold and aggressive media.

Heat sources or temperature fluctuations may cause malfunctions or leaks.

- ▶ Avoid heat sources which may cause the permitted temperature range to be exceeded.
- ▶ Before use, check media resistance.

Destruction of the coil by overheating (only Type 2610).

- ▶ Connect the coil electrically only when the body has been installed.
- ▶ In the case of AC voltage pay attention to movable core.
- ▶ Check media resistance.

General hazardous situations.

To prevent injury, ensure that:

- ▶ Do not feed in aggressive or flammable media.
- ▶ Do not make any internal or external changes.
- ▶ Ensure that the system cannot be activated unintentionally.
- ▶ Installation and repair work may be carried out by authorized technicians only and with the appropriate tools.
- ▶ After an interruption in the power supply or pneumatic supply, ensure that the process is restarted in a defined or controlled manner.
- ▶ Do not put any loads on the body.
- ▶ The general rules of technology apply to application planning and operation of the device.

4 TECHNICAL DATA



The following values are indicated on the type label:

- Type 2610: voltage, current type, coil power consumption
Type 2612, 2620: pilot pressure
- Pressure range
- Body material (MS=brass, VA=stainless steel)
- Seal material (PTFE, NBR)

4.1 Conformity

Type 2610 conforms with the EU Directives according to the EU Declaration of Conformity (if applicable).

4.2 Standards

The applied standards, which verify conformity with the EU Directives, can be found on the EU Type Examination Certificate and / or the EU Declaration of Conformity (if applicable).

4.3 Operating conditions

Ambient temperature

Type 2610 max. +50 °C

Type 2612, 2620 max. +90 °C
 max. +55 °C with attached pilot valve

Degree of protection
 Type 2610 with cable plug: IP65 in accordance with EN 60529,
 NEMA 4X

4.4 Fluidic data

Medium temperature
 Type 2610, 2620 -200—+180 °C
 Type 2612 -10—+90 °C

Viscosity 21 mm²/s

Media neutral gaseous and liquid media, which do not attack body and sealing materials (see table of resistance under www.buerkert.de).
 Check media resistance in individual cases.

Pilot media
 Type 2620 neutral gaseous and liquid media, air, water, hydraulic fluids up to max. 90 °C

Circuit function (CF) Type 2610

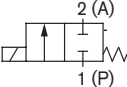
Circuit function A (NC)		2/2-way valve, 1 (P) normally closed
-------------------------------	---	--------------------------------------

Circuit function (CF) Type, 2612, Type 2620

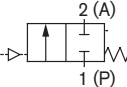
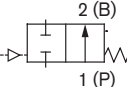
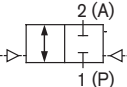
Circuit function A (NC)		2/2-way valve, normally closed by spring action
Circuit function B (NO)		2/2-way valve, normally open by spring action
Circuit function I		2/2-way valve, double-acting diaphragm actuator, any direction of flow

Type 2612

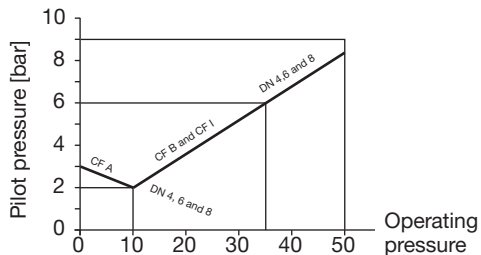

4.5 Mechanical data

Port connections

Type 2610, 2620

G1/4, G1/2

Type 2612

Flange

Materials

Body:

Designation MS

Body: brass, seat: 1.4305 (G1/4)

Body: brass, seat: brass (G1/2)

Designation VA

Body and seat: 1.4410

Actuator

Type 2610, 2620

Epoxy

Type 2612

Aluminium

Metal bellows

Type 2612, 2620

1.4541

Seal material

Type 2610, 2620

PTFE

Type 2612

NBR

Dimensions

Type 2610

see data sheet

4.6 Electrical data (only Type 2610)

Connections	DIN EN 175301-803 Form A: for cable plug Type 2511
Operating voltage	see type label
Voltage tolerance	± 10 %
Power consumption	4 W operation, 72 W inrush
Switching frequency	max. 10/min
Off-time t_{aus} between 2 switching operations	min. 1 s

4.7 Type label (example)

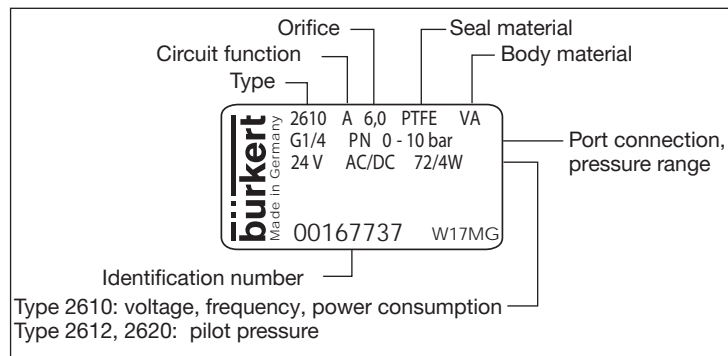

5 INSTALLATION



DANGER!

Risk of injury from high pressure in the equipment.

- ▶ Before loosening the pipes and valves, turn off the pressure and vent the lines.

Risk of injury due to electrical shock.

- ▶ Before reaching into the device or the equipment, switch off the power supply and secure to prevent reactivation.
- ▶ Observe applicable accident prevention and safety regulations for electrical equipment.



WARNING!

Risk of injury from improper installation.

- ▶ Installation may be carried out by authorized technicians only and with the appropriate tools.

Risk of injury from unintentional activation of the system and an uncontrolled restart.

- ▶ Secure system from unintentional activation.
- ▶ Following assembly, ensure a controlled restart.

5.1 Fluid installation

Installation position: any, preferably magnetic system or actuator upright.

- Check pipelines and flange connections for dirt and clean.
- Install a dirt filter before the valve inlet (0.2–0.4 mm).



Observe direction of flow. The arrow on the body indicates the direction of flow.

Type 2610
Type 2620

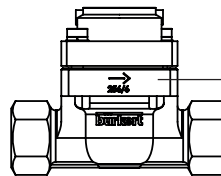

Arrow indicating direction of flow

NOTE!

Caution risk of breakage.

- ▶ Do not use the coil or the actuator as a lever arm.

→ Threaded connection: Hold the device with a open-end wrench on the body and screw into the pipeline.

Flanged connection:



WARNING!

Risk of injury from escaping medium.

- ▶ Leaking connections if seals not seated properly, if manifold uneven or if surface quality of the manifold inadequate.
- ▶ Make certain the seals included with delivery are properly seated in the valve.
- ▶ Ensure that the manifold is even.
- ▶ Ensure that the surface quality of the manifold is adequate.

- Remove the cover plate.
- Insert the seal into the valve.
- Screw the body onto the manifold.

5.2 Electric installation (only Type 2610)



WARNING!

Risk of injury due to electrical shock.

- ▶ Before reaching into the system, switch off the power supply and secure to prevent reactivation.
- ▶ Observe applicable accident prevention and safety regulations for electrical equipment.

If the protective conductor contact between the coil and body is missing, there is danger of electrical shock.

- ▶ Always connect protective conductor.
- ▶ Check electrical continuity between coil and body.



Operate the device only with the cable plug included in the scope of delivery.

Note the voltage and current type as specified on the type label.

- Check that seal is fitted correctly.
- Screw cable plug tightly onto coil (min. 0.5 Nm, max. 0.8 Nm).

5.3 Rotation of the coil (only Type 2610)



WARNING!

Risk of injury due to electrical shock.

If the protective conductor contact between the coil and body is missing, there is danger of electrical shock.

- ▶ Check protective conductor contact after installing the coil.

Overheating, risk of fire.

Connection of the coil without pre-assembled valve will result in overheating and destroy the coil.

- ▶ Connect the coil with assembled valve only.



The coil can be turned by 4 x 90°.

- Loosen nut.
- Turn coil.
- Tighten nut with an open-end wrench (max. 5 Nm).

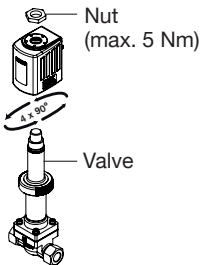

6 MAINTENANCE, TROUBLESHOOTING



WARNING!

Risk of injury from improper maintenance.

- ▶ Maintenance may be carried out by authorized technicians only and with the appropriate tools.

Risk of injury from unintentional activation of the system and an uncontrolled restart.

- ▶ Secure system from unintentional activation.
- ▶ Following maintenance, ensure a controlled restart.

If malfunctions occur, check:

- the line connectors,
- the operating pressure,
- the pilot pressure (only Type 2612, 2620)
- the operating pressure (only Type 2610)

If the valve still does not switch, please contact your Bürkert Service.

7 DISASSEMBLY



DANGER!

Risk of injury from high pressure in the equipment.

- ▶ Before loosening the lines and valves, turn off the pressure and vent the lines.

Risk of injury due to electrical shock.

- ▶ Before reaching into the system, switch off the power supply and secure to prevent reactivation.
- ▶ Observe applicable accident prevention and safety regulations for electrical equipment.



WARNING!

Risk of injury from improper disassembly.

- ▶ Disassembly may be carried out by authorized technicians only and with the appropriate tools.

- Turn off the pressure and vent the lines.
- Switch off the power supply.
- Loosen the cable plug (only Type 2610).
- Hold the device with the open-end wrench on the body and screw off the pipeline.

8 TRANSPORT, STORAGE, DISPOSAL

NOTE!

Transport damages.

Inadequately protected equipment may be damaged during transport.

- ▶ During transportation protect the device against wet and dirt in shock-resistant packaging.
- ▶ Avoid exceeding or dropping below the allowable storage temperature.

Incorrect storage may damage the device.

- ▶ Store the device in a dry and dust-free location.
- ▶ Storage temperature -20 – $+70$ °C.

Damage to the environment caused by device components contaminated with media.

- ▶ Dispose of the device and packaging in an environmentally friendly manner.
- ▶ Observe applicable regulations on disposal and the environment.

Bürkert Fluid Control Systems
Sales Center
Christian-Bürkert-Str. 13-17
D-74653 Ingelfingen
Tel. + 49 (0) 7940 - 10 91 111
Fax + 49 (0) 7940 - 10 91 448
E-mail: info@de.buerkert.com

International address
www.burkert.com

Manuals and data sheets on the Internet: www.burkert.com
Bedienungsanleitungen und Datenblätter im Internet: www.buerkert.de
Instructions de service et fiches techniques sur Internet : www.buerkert.fr

© Bürkert Werke GmbH, 2015
Operating Instructions 1603/05_EU-ML_00804016 / Original DE

www.burkert.com