



**Installation and Maintenance  
Instructions for GC52  
Differential Pressure  
Transmitter**



LOOK FOR THIS  
AGENCY MARK ON  
OUR PRODUCTS

Version 5.0 10/07

© 2007 Ashcroft Inc. 250 East Main Street,  
Stratford, CT 06614 USA  
Tel: 203-378-8281, Fax: 203-385-0402, [www.ashcroft.com](http://www.ashcroft.com)  
All sales subject to standard terms and conditions of sale.  
I&M011-10160 -7/10/08

---

---

---

## CONTENTS

<b>CAUTION</b> .....	4-5
<b>1. PREFACE</b> .....	5
<b>2. OVERVIEW</b> .....	5
<b>3. FEATURES</b> .....	5
<b>4. SPECIFICATIONS</b> .....	6
<b>5. MOUNTING</b> .....	8
5.1 Mounting Location .....	8
5.2 Mounting Options .....	8
5.3 Pressure Connection.....	8
<b>6. PIPING</b> .....	9
<b>7. WIRING</b> .....	10
7.1 Cable / Wiring Specifications.....	10
7.2 Wiring Instructions.....	10
<b>8. DISPLAY FUNCTIONS</b> .....	13
<b>9. MODE CHANGES</b> .....	14
<b>10. POWER-ON MESSAGE</b> .....	14
<b>11. MEASUREMENT MODE</b> .....	15
11.1 Filter (Damping) .....	15
11.2 Pressure Display Mode (Re-scaling in "inH <sub>2</sub> O" units) .....	15
11.3 Linear Display Mode (Re-scaling in arbitrary user defined units) .....	16
11.4 Min/Max Display .....	19
<b>12. ZERO ADJUSTMENT MODE</b> .....	20
<b>13. SETTING MODE</b> .....	20
13.1 Setting Items for Pressure Display Mode (Re-scaling in "inH <sub>2</sub> O" units) .....	21
13.2 Setting Items for Linear Display Mode (Re-scaling in arbitrary user defined units) .....	22
13.3 Setting Procedure .....	25
13.4 Loop Check .....	25
<b>14. DIMENSIONAL DRAWINGS</b> .....	26
<b>15. Maintenance</b> .....	27



## **WARNING! READ BEFORE INSTALLATION**



### **GENERAL:**

A failure resulting in **injury** or **damage** may be caused by excessive overpressure, excessive vibration or pressure pulsation, excessive instrument temperature, corrosion of the pressure containing parts, or other misuse. Consult Ashcroft Inc., Stratford, Connecticut, USA before installing if there are any questions or concerns.

### **OVERPRESSURE:**

Pressure spikes in excess of the rated overpressure capability of the transmitter may cause **irreversible electrical and/or mechanical damage** to the pressure measuring and containing elements.

**Fluid hammer** and surges can destroy any pressure transmitter and must always be avoided. A pressure snubber should be installed to eliminate the damaging hammer effects. Fluid hammer occurs when a liquid flow is suddenly stopped, as with quick closing solenoid valves. Surges occur when flow is suddenly begun, as when a pump is turned on at full power or a valve is quickly opened.

**Liquid surges** are particularly damaging to pressure transmitters if the pipe is originally empty. To avoid damaging surges, fluid lines should remain full (if possible), pumps should be brought up to power slowly, and valves opened slowly. To avoid damage from both fluid hammer and surges, a surge chamber should be installed.

Symptoms of fluid hammer and surge's damaging effects:

- Pressure transmitter exhibits an output at zero pressure (large zero offset).
- Pressure transmitter output remains constant regardless of pressure
- In severe cases, there will be no output.

### **FREEZING:**

Prohibit freezing of media in pressure port. Unit should be drained to prevent possible overpressure damage from frozen media.

### **STATIC ELECTRICAL CHARGES:**

Any electrical device may be susceptible to damage when exposed to static electrical charges. To avoid damage to the transmitter observe the following:

- Ground the body of the transmitter **BEFORE** making any electrical connections.
- When disconnecting, remove the ground **LAST!**

Note: The shield and drain wire in the cable (if supplied) is not connected to the transmitter body, and is not a suitable ground.

---

## **USE IN LIFE SUPPORT DEVICES**

Ashcroft Inc. products are not authorized for use as critical components in life support devices or systems without the express written approval of the General Manager, Stratford Operations of Ashcroft Inc. As used herein:

Life support devices or systems are devices or systems which, (a) are intended for surgical implant into the body, or (b) support or sustain life, and whose failure to perform, when properly used in accordance with instructions for use provided in the labeling, can be reasonably expected to result in a significant injury to the user.

A critical component is any component of a life support device or system whose failure to perform can be reasonably expected to cause the failure of the life support device or system, or to affect its safety or effectiveness.

### **1. PREFACE**

Thank you for purchasing the GC52 Rangeable Differential Pressure Transmitter. Refer to the Ashcroft GC52 Data Sheet for product specifications and applicable operating conditions.

### **2. OVERVIEW**

The GC52 is a 4-20mA loop powered (two-wire) differential pressure transmitter with integral display incorporating Ashcroft's proven SiGlas silicon based variable capacitance sensor with stainless steel media isolation diaphragms and silicone pressure transmission fluid. The device was designed to offer the user small size and user adjustable ranging for applications such as tank level measurements and gas / liquid flow measurements.

### **3. FEATURES**

- (1) **Media Compatibility:** Wetted materials consist of 316 stainless steel, alumina ceramic and viton to handle a wide range of media with the ability to offer ranges as low as 4" W.C. F.S. (URL).
- (2) **Linear Scaling Function:** The linear (scaling) function allows the user to adjust zero and span values providing a corresponding 4-20mA output signal.
- (3) **Digital Filter Function:** User adjustable damping of the output signal by means of internally calculated moving average to provide a stable output signal in applications where the user wants to reduce the pulsating of the display and / or output signal.
- (4) **LED Back Light:** To supplement the LCD display when conditions require (dark area, night etc.).

- (5) **Loop Check Function:** Allows the user to output an analog signal corresponding to differential pressure without applying pressure, simplifying system maintenance and troubleshooting.
- (6) **Zero and Span Adjustment:** The adjustment of the Zero (4mA) and Span (20mA) reading via internal push buttons.
- (7) **IP65 / NEMA 4X Environmental Rating:** Enclosure environmental rating suitable for indoor and outdoor installation, depending upon operating temperature range.\*
- (8) **CE Compliance:** EN613261 1997, A1/1998, A2/2001 (Heavy Industrial).

\*Display not to be mounted in direct sunlight.

#### 4. SPECIFICATIONS

ITEM	DESCRIPTION
<b>1. Media/Wetted Parts</b>	Gas or liquid compatible with 316SS, viton and alumina ceramic (isolation fluid is silicone oil). Media temperature range: -10 to +70°C
<b>2. Overpressure (Proof)</b>	Static (Line) Pressure: 300psi all ranges Single Side (Differential) Limits: • Pressure Ranges <8°W.C., ±4°W.C.; 30psid • Pressure Ranges >20°W.C., ±8°W.C.; 100psid
<b>3. Supply Voltage</b>	12-32Vdc
<b>4. Output</b>	4-20mA (two wires, Output range: 3.2 to 20.8mA) Response Time: 100ms (with "0" filter setting) Resolution: 0.1%F.S., Load resistance: 500Ω max.
<b>5. Accuracy</b>	±0.5% F.S. (URL) at 73°F (23°C); includes the effects of non-linearity, hysteresis and non-repeatability)
<b>6. Display Accuracy</b>	±0.50% F.S. (URL) + 1 digit at 23°C
<b>7. Rangeability / Adjustment</b>	Zero: -10 to +110% FS Span: -10 to + 110% FS
<b>8. Display</b>	Character height: 10mm, with LCD display with LED backlight
	Pressure / linear display: (4) LCD digits max. Display update: 500 ms

<b>9. Units</b>	Pressure Units: inH <sub>2</sub> O (2), (1) arbitrary
<b>10. Setting Adjustments</b>	Internal key switches (Mode, ▲, ▼) Scaling function: Linear output Filter function: User adjustable output damping select from 0, 2, 4, 8 and 16 (None, 2, 4, 8, and 16 (s)). Loop check function: User adjustable output for loop/system check and troubleshooting, 4-20mA.
<b>11. Enclosure</b>	Material: Aluminum die cast Environmental Rating: IP65 / NEMA 4X
<b>12. Pressure Connection</b>	¼ NPT female pressure ports w/equalizing valve
<b>13. Electrical Termination</b>	Cable Gland (Optional): Cable diameter 0.35 to 0.47" (9-12mm) ½ NPT Female Conduit Adapter (Optional) Terminal Block: 14-22 AWG (stranded or solid wire)
<b>14. Memory Protection</b>	Permanently stored by EEPROM (nonvolatile memory)
<b>15. EMC Directive</b>	CE Compliance: EN61326/1997, A1/1998, A2/2001
<b>16. Operating Temperature</b>	-10 to 60°C (14 to 140°F)
<b>17. Storage Temperature</b>	-20 to 70°C (-4 to 158°F)
<b>18. Vibration</b>	5g's, 150Hz
<b>19. Shock</b>	10g's, 16ms
<b>20. Insulation Resistance</b>	50Vdc, 100MΩ or more
<b>21. Weight</b>	Approx. 670g (1.5lbs)

---

## 5. MOUNTING

### 5.1 General

The GC52 was designed to be mounted using the bracket supplied. Pressure connections via the (2) ¼NPT female pressure ports. Although the display can be rotated in 90 degree increments by removing the display cover it is preferable to orientate the electrical termination downward, particularly in applications where protection from the environment is required.

### 5.2 Mounting Orientation

It is preferable to orientate the unit with the pressure ports either downward or upward. If mounting with pressure ports to the side an "orientation effect" will be seen at zero pressure as the pressure generated by the silicone oil fill will appear as a zero offset. If mounting in this manner this effect may be taken out by re-setting zero in final mounting orientation.

### 5.3 Installing Pressure Port Manifold

#### (1) Mounting 25.4mm Manifold (¼" NPT female ports)

Manifold is secured using the (4) socket head bolts (M4x40) and appropriate allen wrench which is supplied. Check for dust and dirt on the O-ring and seal area, clean if necessary, before installing to ensure proper connection. The direction of the manifold is not important, determine best position by ability to operate the equalizing valve. The equalizing valve is used to open both ports to the line pressure at time of installation. Once installed and the system has been pressurized the valve needs to be closed to isolate the low and high pressure sides of the device.

**Tighten the equalizing valve with a torque of 0.75 ft-lbs±15%. When loosening the valve do not back off by more than three turns from the closed position.**

#### (2) Panel Mounting

Similar to (1) above except that the GC52 is put between the manifold and the bracket and then the (4) socket head bolts (M4x40) are installed.



## Lower connection diagram

Connection: Lower side.

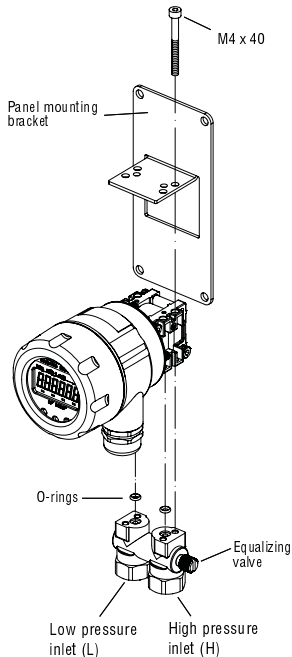
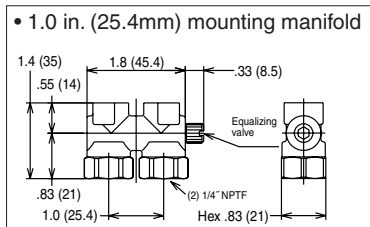

## 6. PIPING

Note: High (H) and Low (L) pressure sides of the device are marked on the yellow label affixed to the housing of the unit.

Install the high pressure side of the applied differential pressure in the pressure inlet of the high pressure side (H) and the low pressure side in the pressure inlet of the low pressure side (L).

(Refer to the outline drawing of section 14.)

After the piping is completed check for leaks.

### (1) Piping of 1.0 in (25.4mm) Manifold (1/4" NPT female ports)

Use caution when installing to keep metal chips and other debris from entering pressure transmitter. In addition, when sealing tape is used, do not apply to last two threads at the end of the fitting

---

**Note:**

- When transporting and / or mounting do not apply excessive shock or use device as a step.
- The piping should be of proper length so as not to apply load to the connection point on the transmitter.
- At the time of mounting or when bleeding air from the device be sure to open the equalizing valve with a flathead screwdriver so that excessive pressure (more than the allowable maximum differential pressure) is not applied to the differential pressure sensor. Maximum torque to apply to equalizer valve is 0.75 ft-lbs  $\pm$ 5%.

**7. WIRING****7.1 Cable/Wire Specifications**

Use appropriate cable described below which is suitable for power supply requirements and ground to housing.

Terminal Strip	SMKDSP1.5/2-5.08 Phoenix Contact
Cable Requirements	<ul style="list-style-type: none"><li>• Two core shielded cable</li><li>• Cable outer diameter: 0.35" to 0.47" 9-12mm (Required for correct installation with Cable Gland option)</li><li>• Wire Gauge: 14-22 AWG (multi-strand or solid)</li></ul>

**7.2. Wiring Instructions**

- To reduce potential for noise do not run pressure transmitter cable / wires alongside (same conduit as) high voltage (line power) lines. For optimum results use dedicated conduit for GC52 cable / wires.
- If using the Cable Gland termination option must use cable within previously noted diameters to maintain environmental ratings.
- When connecting shield / drain wire, only connect one end which should be at the receiver ground.
- Wiring stripping instructions, remove cable jacket 2-3" and strip wires  $\pm$ 0.25". Shield / drain wire should not be exposed at the pressure transmitter termination.
- Remove cover and carefully remove the display to access the terminal strip, take care not to mishandle the display and associated electronics.

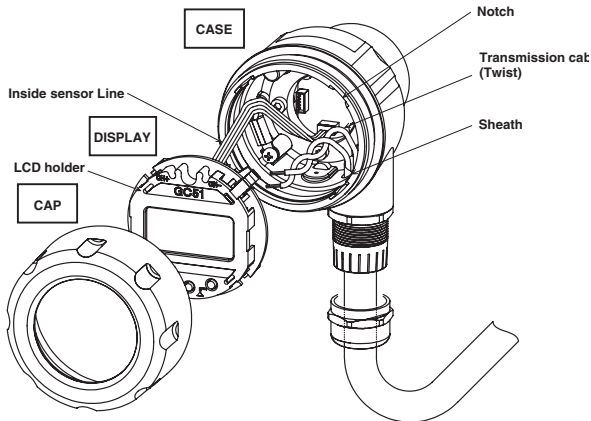
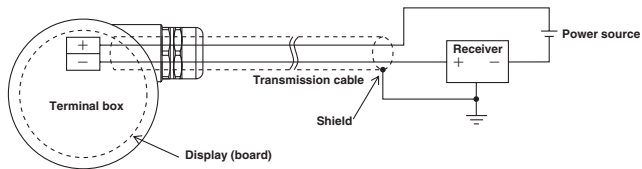

- Turn display over to expose terminal strip, make positive and negative connections, insert wire depth is equal to recommended strip length (0.25").

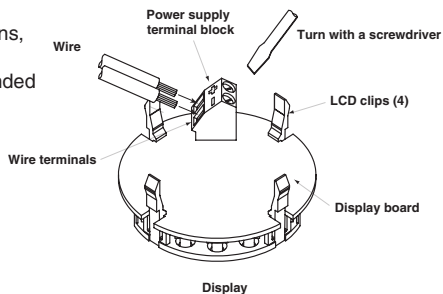

- After completing connections locate retaining clips in the appropriate notches and carefully place into the housing. Be sure that internal sensor transmission wire does not cross the power supply lines just installed.
- If using the Cable Gland be sure to properly tighten sealing grommet before applying any tension on the cable, the cable gland provides strain relief and environmental sealing.
- Tighten GC52 cover to maintain environmental rating.
- Connect to power source and receiver and power on to confirm correct wiring (see Section 10 for more detail).
- Power Supply Requirements: Although the 4-20mA signal can travel over long distances one of the most common problems is inadequate power at the pressure transmitter due to the voltage drop across the loop. Be sure to review table below to determine that 12-32V is getting to the pressure transmitter.

### Load Limitations 4-20mA Output Only

Loop Resistance ( $\Omega$ )

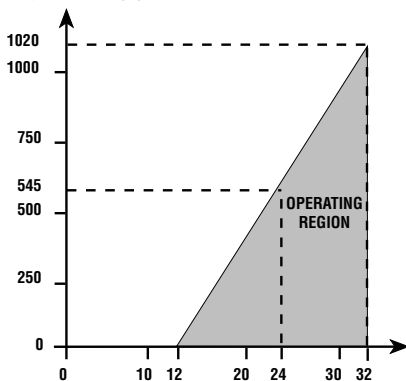

## 8. DISPLAY FUNCTIONS

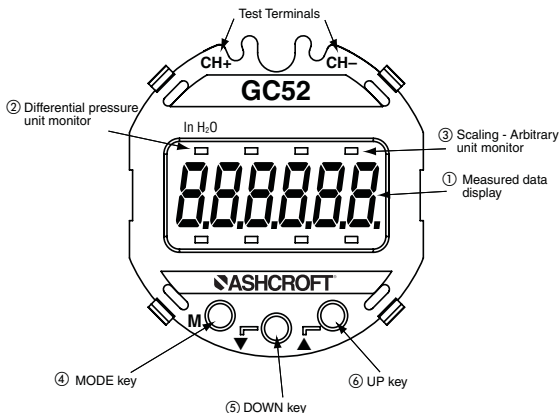

DESIGNATION	FUNCTION
① <b>Measured data display</b>	Differential pressure, linear scaling value are displayed.
② <b>Differential pressure unit monitor</b>	When this unit monitor is ON, the differential pressure (in H <sub>2</sub> O) is indicated on the measured data display.
③ <b>Scaling; arbitrary unit monitor</b>	When this unit monitor is ON, the scaling value of an arbitrary unit (linear scaling), is indicated on the measured data display.
④ <b>MODE key (M)</b>	This key is used to switch the setting mode and the measurement mode and to change the setting item.
⑤ <b>DOWN key</b> ▼	This key is used to change (decrease) and select the set value .
⑥ <b>UP key</b> ▲	This key is used to change (increase) and select the set value and to shift from the measurement mode to the zero adjustment mode.

## 9. MODE CHANGES

- Measurement Mode (Section 11 for further detail) will be entered upon power-on. Setting Mode (Section 13 for further detail) is entered by pressing and holding the MODE button for more than 3 seconds. If there is no button operation for 10 minutes in the setting mode, it will shift back to the Measurement Mode automatically.
- To go from the Measurement Mode to the Zero Adjustment Mode (Section 14 for further detail) press and hold the UP ▲ button for more than 3 seconds.

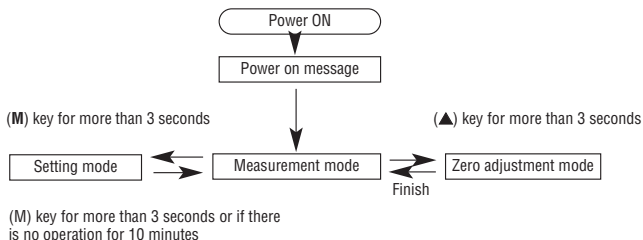

## 10. POWER-ON MESSAGE

After the power is turned on, the power-on message is displayed for 6 seconds as shown below and then the display is shifted to the measurement mode (section 13). In addition, the analog output during power-on message is at the zero point (4mA).

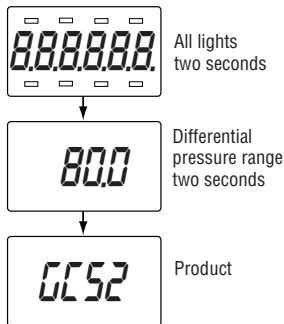

---

## 11. MEASUREMENT MODE

The measurement mode includes differential pressure display mode, and linear (scaling) display mode. For the setting items ① to ⑳, please refer to the Setting Mode (section13.1).

### 11.1 Filter

Set the filter before setting pressure display mode or linear (scaling) display mode.

The filter is based on the moving average of the pressure data to decrease display “bounce” and to smooth the analog output due to system pressure fluctuations at the user’s discretion.

Five selections: (0, 2, 4, 8, and 16 seconds).

If “0” is selected the filter is not applied.

See page 24 for full menu.

Filter Setting	⇒ item ①
----------------	----------

### 11.2 Differential Pressure Display Mode (Re-scaling in “inH<sub>2</sub>O” units)

This mode is used for display and analog output of the actual differential pressure.

#### (1) Analog output

The analog output can be adjusted as follows; the zero point (4mA) and the span point (20mA) can each be adjusted from -10 to 110%F.S. (URL)\*.

#### (2) Pressure display

The **pressure display** has a display span between the zero point and the span point as determined by the adjustment of zero and span (see previous paragraph) and can display the range of -5 to 105%F.S.(URL). In addition, the decimal point position of the pressure display is fixed for each pressure range.

**Pressure Unit:** in.H<sub>2</sub>O

See page 24 for full menu.

Output zero point and span point setting	⇒ Setting item ③, ④
--	---------------------

\*This means that although the zero point is typically set at 0%F.S. (in the case of bi-directional ranges 0%Span) and the span point is set as 100%F.S., the zero point can be adjusted to the point where zero (4mA) is 110%F.S. and the span point (20mA) can be adjusted to -10%F.S thus reversing the output. In addition, through this adjustment zero and span can be adjusted accordingly for elevated tank levels.

### Setting example 1 : Differential pressure display mode

The setting to use the differential pressure range 0 to 20in.H<sub>2</sub>O ("W.C.") and to display the zero point and span point of the analog output as -2 in.H<sub>2</sub>O and 18 in.H<sub>2</sub>O respectively is as follows:

In the example the filter (moving average time) is set at 2 seconds, the differential pressure display and the analog output are based on the moving average equivalent to the differential pressure data per 100ms for the past 2 seconds (20 times).

Select the filter of "2 seconds"	⇒ Setting item ①
Select the "Differential pressure display mode"	⇒ Setting item ②
Set output zero point as "-10.0%F.S."	⇒ Setting item ③
Set output span point as "90.0%F.S."	⇒ Setting item ④

#### ■ Display and analog output

Ex. Differential pressure of 8 inH<sub>2</sub>O

- Differential pressure display: 8.00(H<sub>2</sub>O)
- Analog output: 12(mA) in.H<sub>2</sub>O



	Differential Pressure Display (inH <sub>2</sub> O)	⇒	Analog Output (mA)
Output span point	18.00	⇒	20
	∫		∫
	8.00	⇒	12
Output zero points	-2.00	⇒	4

### 11.3 Linear Display Mode (Re-scaling in arbitrary user defined units)

This mode is used for display / analog output of the scaling value where the differential pressure is linearly converted to an arbitrary physical quantity.

#### (1) Linear display

By setting the OFFSET to the minimum differential pressure P<sub>1</sub> and the FULL SCALE to the maximum differential pressure P<sub>2</sub>, the linear display indicates the value on the line between the two points (the maximum display span). The actual linear display span depends on the setting of the zero point and span point of the analog output as shown in (2) of the next page. It can display the range of -5 to 105%F.S. of the linear display span.



- The setting range for the **minimum differential pressure  $P_1$**  and the **maximum differential pressure  $P_2$**  is 0 to 100%F.S. of the differential pressure range, and the maximum differential pressure  $P_2$  is set from the value which is more than 25%F.S. of the differential pressure range above the minimum differential pressure  $P_1$ .
- The setting range for the **OFFSET** and **FULL SCALE** values is  $-1999$  to  $1999$ , and the decimal point can be set arbitrarily. At this time, the arbitrary unit monitor turns on

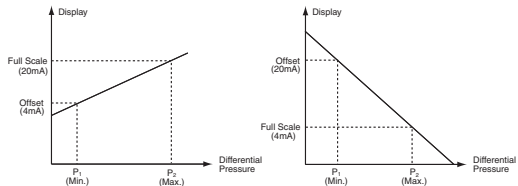

See page 24 for full menu.

Min. differential pressure $P_1$ and max. differential pressure $P_2$ setting	⇒ Setting item ⑥, ⑦
OFFSET & FULL SCALE setting	⇒ Setting item ⑧, ⑨, ⑩

## (2) Analog output

The zero point (4mA) and span point (20mA) of analog output can be set in the range of  $-10$  to  $110\%$ F.S. of the maximum display span (between OFFSET and FULL SCALE). The span between the zero point and the span point in this analog output is the linear display span.

Analog output zero point and span point setting	Setting item ⑪, ⑫
--	-------------------

As shown in the previous diagram, usually, the OFFSET is set as Output zero point (4mA) and the FULL SCALE is set as Output span point (20mA), but the OFFSET can be reversed to Output span point (20mA) and the FULL SCALE can be reversed to Output zero point (4mA).

### ■ Setting example 2 : Linear display mode

A level gauge using a differential pressure range of 0 to 200 in. $H_2O$ , the linear display setting to display the OFFSET for minimum 20 in. $H_2O$  as 0.0, the FULL SCALE for maximum differential pressure 120 in. $H_2O$  as 50.0, the unit as arbitrary unit (m), the zero point (4mA) analog output as 0.0, and the span point (20mA) as 50.0 is as follows:

See page 24 for full menu.

For display mode, select "Linear display mode"	⇒ Setting item ②
Set min. differential pressure P1 as "20 in.H <sub>2</sub> O"	⇒ Setting item ⑥
Set max. differential pressure P2 as "120 in.H <sub>2</sub> O"	⇒ Setting item ⑦
Set decimal point position of linear display as "one digit"	⇒ Setting item ⑧
Set OFFSET of linear display as "0.0m"	⇒ Setting item ⑨
Set FULL SCALE of linear display as "50.0m"	⇒ Setting item ⑩
Set output zero point as "0.0%F.S." (0.0m) of max. display span*	⇒ Setting item ⑪
Set output span point as "100.0%F.S." (50.0m) of max. display span*	⇒ Setting item ⑫

\*Maximum display span: OFFSET to FULL SCALE

### ■ Linear display and analog output

Ex. Differential pressure 70 in.H<sub>2</sub>O

- Linear display: 25.0(m)
- Analog output: 12(mA)

m <sup>(1)</sup>	Differential Pressure (in.H <sub>2</sub> O)	Linear Display (m)	Analog Output (mA)
	120 ⇒	50.0 ⇒	20 Span Point
	f	f	f
	<b>70</b> ⇒	<b>25.0</b> ⇒	<b>12</b>
	20 ⇒	0.0 ⇒	4 Zero Point

(1) Put the arbitrary unit sticker.

---

## 11.4 Out of Range Display

### (1) Range Over display

In the Measurement Mode, if the pressure is below  $-15\%$  F.S. (URL) “-FFF” will be displayed, and if it is more than  $115\%$ F.S., “FFF” will be displayed.

### (2) Span Over display

When the user has adjusted the span of the device this case will apply. The display range in each display mode is  $-5$  to  $105\%$ F.S. of the display span. When this range is exceeded, the value of  $-5\%$ F.S. or  $105\%$ F.S. will be held (depending upon whether unit is below or above the span values) in a blinking state.

### (3) Analog output

The analog output is linked with the display and is at  $3.2\text{mA}$  when the display span is at or exceeded  $-5\%$ F.S. and at  $20.8\text{mA}$  when the display span is at or greater than  $105\%$ F.S.

## ■ Out of Range Display

Differential pressure mode (Differential pressure range  $0$  to  $20\text{in.H}_2\text{O}$ )

Pressure display span  $20\text{in.H}_2\text{O}$ )

Span point:  $200$

Zero point:  $00$

- Overage display

---

- Overage display

-15%F.S. (-3.0 inH<sub>2</sub>O) more/less

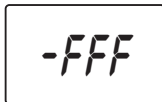

115%F.S. (23.0 inH<sub>2</sub>O) more/less



- Span over display

- 5%F.S. (-1.0 inH<sub>2</sub>O) more/less



105%F.S. (21.0 inH<sub>2</sub>O) more/less



## 12. ZERO ADJUSTMENT MODE

In the measurement mode, the pressure connection (H, L) is open to the atmosphere and  key is pressed for more than 3 seconds in order to shift to zero adjustment mode (refer to section 11) for zero point adjustment of the differential pressure sensor.

- If the zero point adjustment is correctly performed, the message "Adj" will be displayed for 2 seconds, and the display will return to the measurement mode.
- If zero point correction is performed when the applied pressure is over  $\pm 10\%$ F.S., the error message "E-0" will be displayed for 2 seconds, and the display will return to the measurement mode without completing the zero point adjustment.

- Normal Message -



- Error Message -

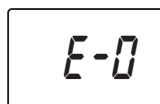

**CAUTION:** Only perform the zero point correction when both the H and L ports are open to the atmosphere. If done incorrectly the accuracy of the device may be effected.

## 13. SETTING MODE

The setting modes include differential pressure display mode setting and linear display mode setting. In addition, loop check (refer to section 13.4) can be performed in each mode setting.

For the setting procedure of each display mode, refer to paragraph 13.4.

**13.1 List of Setting Items for Differential Pressure Display Mode**  
(Re-scaling in “inH<sub>2</sub>O” units). Set the filter before setting the differential pressure setting mode. See page 24 for full menu.

No.	Setting Item	LCD Display	Setting Description	Setting Range	Default*
①	Filter		Selection of moving average time of differential pressure: 2 (sec)	0,2,4,8,16,sec	4

\*The factory default.

The setting of the following table is the Setting example  
1: pressure display mode of SECTION 11-2. This applies when re-scaling in “inH<sub>2</sub>O” units. See page 24 for full menu.

No.	Setting Item	LCD Display	Setting Description	Setting Range	Default
②	Display mode		Selection of differential pressure display mode: non	non: Differential pressure display mode Lin: Linear display mode	non
③	Output zero point <sup>(1)</sup>		Differential pressure of analog output zero point 4mA: -10.0(%F.S.)	Differential pressure range: -10 to 110%F.S.	0.0
④	Output span point <sup>(1)</sup>		Differential pressure of analog output span point (20mA): 90.0(%F.S.)	Differential pressure range: -10 to 110%F.S.	100.0
⑤	Loop check <sup>(2)</sup>		Arbitrary change of differential pressure display and analog output: -10.00 (psi.)	Display: Differential pressure display span; Analog output: 4 to 20mA	0.0 (4.00 mA)

(1) For setting of zero point and span point in the analog output, input the percent value over the differential pressure range.

(2) Regardless of generated differential pressure, the loop check can be changed by arbitrarily linking the pressure display with the analog output using ▲, ▼ key. (Refer to Section 13.3). This example of LCD display shows the zero point display at the time of loop check start.

- 13.2 Setting Items for Linear Display Mode** (Re-scaling in arbitrary user defined units) Set the filter before setting the linear display mode (Refer to the preceding Section 11.1). The setting of the following table is the Setting example 2: Linear display mode of Section 11.3. (Arbitrary unit: m). This applies when re-scaling in arbitrary user defined units. See page 24 for full menu.

No	Setting Item	LCD Display	Setting Description	Setting Range	Default
②	Display mode		Selection of linear display mode: Lin	non: Differential pressure display mode; Lin: Linear display mode	non
⑥	Min. differential pressure <sup>(1)</sup>		Min. differential pressure corresponding to OFF-SET (⑨):20.0(inH <sub>2</sub> O)	Differential pressure range: 0 to 75%F.S.	0.0
⑦	Max. differential pressure <sup>(1)</sup>		Max. differential pressure corresponding to FULL SCALE (⑩):120inH <sub>2</sub> O)	Differential pressure range: 25 to 100%F.S.	100.0
⑧	Decimal point position		Display after decimal point Number of digits:1(digit)	0,1,2,3 digit	0
⑨	OFFSET		OFFSET corresponding min. differential pressure (⑥): 0.0 (m)	-1999 to 1999	0
⑩	FULL SCALE		FULL SCALE corresponding to max. differential pressure (⑦):50.0 (m)	-1999 to 1999	1000
⑪	Output zero point <sup>(2)</sup>		Analog output zero point : (4mA): 0.0 (%F.S.)	Max. display span: -10 to 110%F.S.	0.0
⑫	Output span point <sup>(2)</sup>		Analog output span point : (20mA): 100.0 (%F.S.)	Max. display span: -10 to 110%F.S.	100.0
⑬	Loop check <sup>(3)</sup>		Arbitrary change of linear display and analog output: 50.0 (m), 20mA	Display: Linear display span; Analog output: 4 to 20mA	0 (4.0mA)

- 
- (1) The decimal point position is fixed for each differential pressure range. (Refer to section 10, Power-on Message).

The maximum differential pressure can be set from the value which is 25%F.S above the minimum differential pressure.

The values under 25%F.S. cannot be increased or decreased by ▲, ▼ key.

- (2) For setting zero point and span point of the analog output, input the percent value over the maximum display span (between OFFSET and FULL SCALE). Its decimal point position can be set up to one digit after the decimal point (xx.x).
- (3) Regardless of whether pressure is applied or not, the loop check can be activated which links the display and the output allowing the operator to arbitrarily adjust the output to check the system, troubleshoot etc (using the ▲, ▼ keys), ref section 13.4. This example shows the display set to the span point.

### 13.3 Setting Procedure (Setting Examples from 13.1, 13.2)

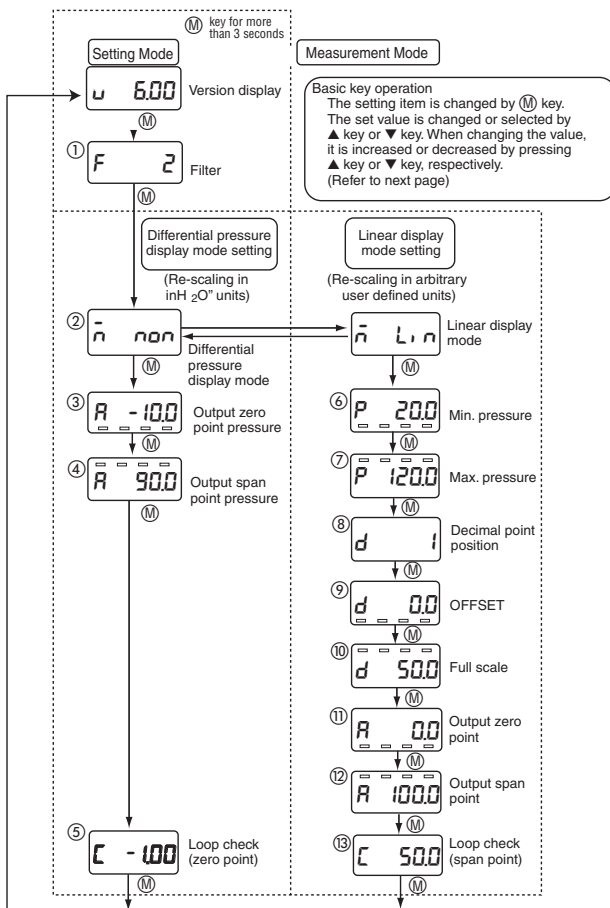



## 13.4 Loop Check

In each display mode, regardless of applied pressure, the loop check can be changed by arbitrarily linking the display with the analog output using the key operation. The display will show representative pressure readings correlating to the 4-20mA signal.

### ■ Loop check method

- (1) Remove the lid of this product.
- (2) Shift to either the Differential Pressure or the Linear Display Mode. (See Section 13.1 or 13.2.) Use (M) button to scroll to Loop Check function as indicated within Section 13.1 or 13.2 respectively. The display and output (4mA) are at the zero point when loop check starts.
- (3) If the  $\odot$  is pressed, the display will increase along with the output. By pressing  $\ominus$  key, decrease will occur. Release the key at the desired indication.

For example, if the key is released at 25.0m, the display will stop and be held at analog output 12mA corresponding to the indication, ref. example from section 13.2

### ■ Analog Output Check Terminals

When the front cover is removed, the analog output check terminals (pad: CH+, CH-) are visible at the upper part of the display substrate. The analog output can be checked during measurement mode or loop check by applying a probe, such as a tester for current measurement, onto the check terminal of the substrate, as shown in the following figure. In addition, receivers are not affected by the tester's probes.

#### Loop check / linear display

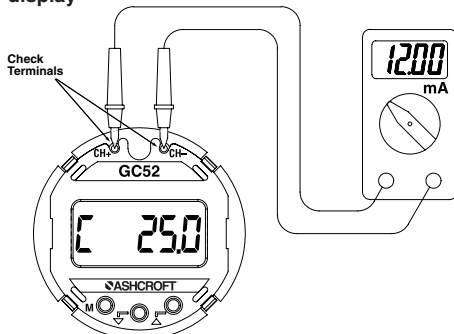

## 14. DIMENSIONAL DRAWINGS

Dimensions in inches

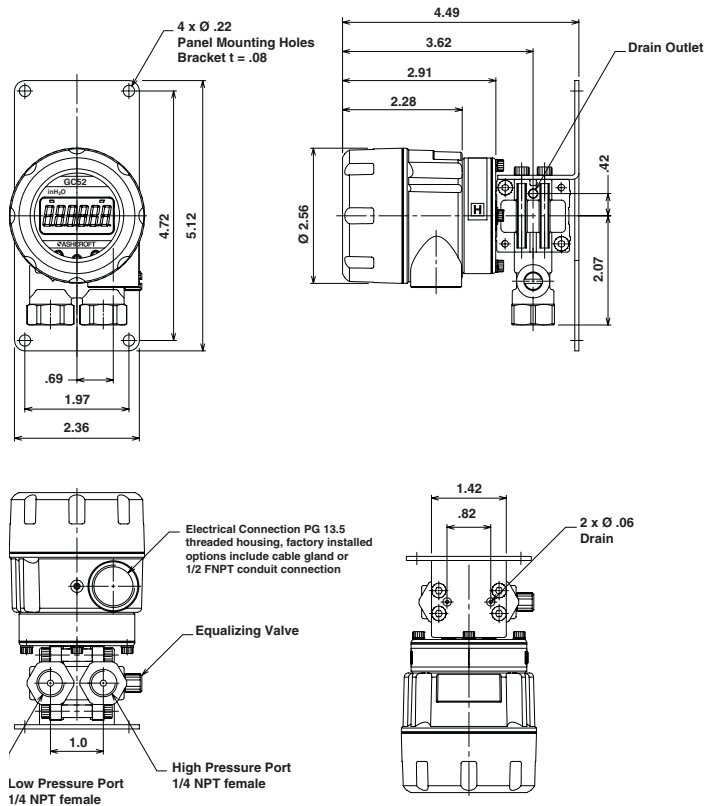

---

## 15. MAINTENANCE AND WARRANTY

### ■ **Periodic inspection**

Depending upon the type of use periodic inspection is recommended at least once a year. Please refer to the following items for periodic inspection.

**(1) Appearance**

**(2) Display/output check via appropriate pressure standard<sup>(1)</sup>**

**(3) Display/output check via Loop Check<sup>(2)</sup>**

### ■ **CAUTION**

- Avoid electrostatic charging. When cleaning this product, please use a soft, damp, cloth.
- Do not use thinner, etc. which may cause deterioration and failure.

### ■ **Product warranty**

Except as otherwise provided, the product warranty of this product is as follows:

Period: 12 months after delivery

Warrantable defects: Defects resulting from the design and manufacture of our company, the quality of the material, etc.

Implementation of warranty: This warranty will be completed by substitution or repair of the product concerned.

We will not take responsibility for consequential damages caused by product defects.

- If you have any questions about this document, please contact the sales office or distributor nearest you.
- This document is subject to change without notice due to upgrade etc.

(1) If zero correction is required refer to section 12.

(2) Loop check, see section 13.4.

---

© 2007 Ashcroft Inc. 250 East Main Street,  
Stratford, CT 06614 USA  
Tel: 203-378-8281, Fax: 203-385-0402, [www.ashcroft.com](http://www.ashcroft.com)  
All sales subject to standard terms and conditions of sale.  
I&M011-10160 -7/10/08