



deTec

BECAUSE WE TAKE SAFETY TO THE NEXT LEVEL

Safety light curtains

SICK
Sensor Intelligence.



ALL OF OUR EXPERIENCE GOES INTO YOUR SUCCESS

SICK offers more than 65 years of experience in the area of safety solutions. SICK developed the very first light curtain for accident prevention on machinery back in the 1950s. With plenty of expertise, we continuously work on improving our deTec product family in order to provide you with crucial benefits when using this safety light curtain.





Count on future proof investments



With the NFC technology, you have entirely new options for on-site diagnosis using a smartphone. IO-Link also makes it possible to read out diagnostic data continuously regardless of your location. The data acquired in this way can then be used for subsequent process steps in an Industry 4.0 approach.

→ see page 4



Save time and money



The entire deTec product family enjoys standardized connectivity and product-specific accessories. This considerably reduces the variety of versions. Featuring sophisticated modularity, the deTec4 enables necessary functions to be activated using the matching system plug. And an improved alignment display directly on the device saves time, making additional software unnecessary.

→ see page 5



Intelligent protection for more productivity



The extended functional range of the deTec4 over the previous models is innovative, ensuring increased availability of machines and systems. With the optional “smart presence detection” function, the deTec4 ignores chips and weld sparks (among other field disturbants) that fall into the protective field and does not switch until the vertical protective field is interrupted. For applications in which the protective field width varies during operation, the “dynamic protective field width” function offers a high level of flexibility.

→ see page 6



Safety guaranteed on all levels



Design your machine to be safe. SICK has taken all of its experience in the area of safety solutions and put it into the deTec product family. The intelligent deTec4 device concept illustrates our innovative approach concerning productivity while continuing to keep our focus on the most important objective – the protection of people.

→ see page 7



BECOME A TECHNOLOGY LEADER

In making a decision on investment in safety solutions, there is one aspect that is especially targeted: being future proof. With the innovative deTec product family, you are securing a vital technological advantage today, and getting a good, well equipped start into a successful future. With the deTec4, SICK is the first manufacturer of safety light curtains to provide on site diagnostics by means of innovative NFC technology for smartphones or tablets.

Increased productivity and short downtimes – the future of mobile maintenance



SICK Safety Assistance
in the Google Play Store



- + The future-oriented NFC technology supports fast device configuration as well as extensive and innovative diagnostics options via smartphone app.

Safety and automation united – IO-Link makes a cost-effective system design possible

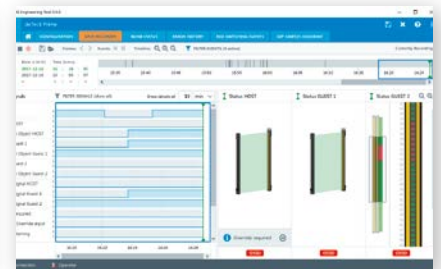

- + With data made available by the IO-Link, comprehensive diagnostics are possible, and the data can be used directly in other process steps. For example, a subsequent step could apply the provided height measurement data while simultaneously executing a safety function, without the need for additional equipment components.





TIME IS MONEY – WITH deTec YOU SAVE BOTH

The profitability of an investment begins with quick commissioning. With the deTec4, your safety solution is ready to use quickly – the light curtain features standardized connectivity and, in comparison with previous versions, now has a uniform housing design. Matching accessories are available for the deTec4 as well. The safety light curtains shine while in operation – and also in case of service – with an excellent cost-benefit ratio.

Reduced configuration effort



- + With the innovative SP1 and SP2 system plugs, you can easily activate the desired functions without software.
- + The smartphone app or the SOPAS ET configuration software makes configuration with the DIP switch assistant easier. For example, it displays the correct settings on the system plug for you. The light curtain can also be easily adjusted using the signal strength display of each individual light beam.

Fast commissioning

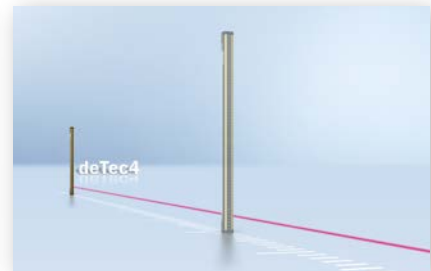

- + Quick and easy alignment and excellent ease of use directly on the light curtain. Four blue LEDs display the strength of the signal. The synchronization status of the uppermost and lowermost beams can also be visualized. Thanks to an integrated laser alignment aid, adjusting and using the system takes no time at all.
- + The entire deTec product family features a uniform housing design while being equipped with identical mounting systems as well as compatible standard cables, including product-specific accessories.



INTELLIGENT PROTECTION FOR MORE PRODUCTIVITY

Unnecessary downtimes and machine failures rapidly impact productivity. deTec4 provides support to machine operators and maintenance personnel in the efficient operation of machines and systems. The extended range of functions of the deTec4 over the predecessor models is an innovation, resulting in increased availability. With the automation and measurement functions, you already have an eye toward the future. Easy configuration, completely without software, saves additional time and money.



2-signal muting and IO-Link

- + Safety and automation in one: Muting station with height measurement through IO-Link.

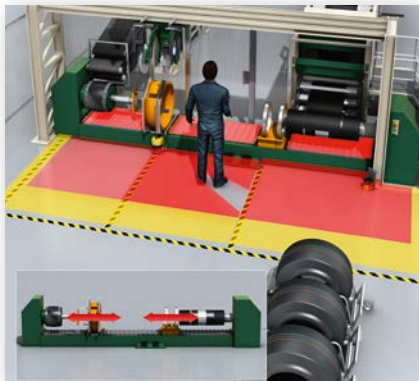

Dynamic protective field widths

- + High level of flexibility: "Dynamic protective field widths" during operation.

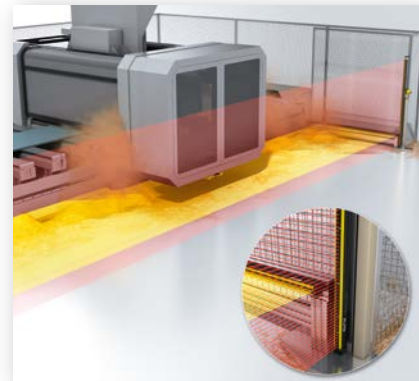

Smart presence detection

- + Safe productivity and availability: "Smart presence detection" prevents unwanted shutoffs.

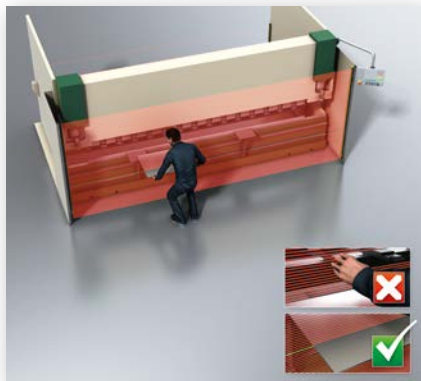

Reduced resolution

- + Safety and availability using intelligent evaluation algorithms. Small objects such as thin sheets, chips or little creatures such as insects will not lead to a machine shutoff – whereas hands will certainly be detected.

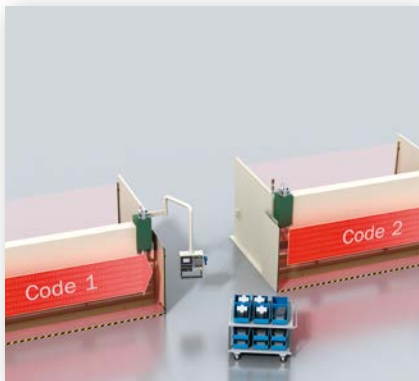

Beam coding

- + The highest availability and prevention of unwanted shutoffs using beam coding on adjacent machines.



Reducible transmitting power

- + When the distance between machines is low, the transmitting power of the deTec4 can be reduced, thereby not influencing the receivers of an adjacent system.



SAFETY GUARANTEED ON ALL LEVELS

The deTec4 safety light curtains represent reliable protection for people – without compromising productivity and efficiency. SICK has placed all of its experience into the development of light curtains in the area of safety solutions: Protective field heights of 300 to 2,100 mm, performance level e, safety integrity level 3, Type 4, IP65, IP67 and IP69K enclosure ratings, a high temperature resistance between -30 °C and +55 °C and special for especially harsh fields of application ensure reliable processes and functional safety.



Standardized connectivity and product-specific accessories

+ For the entire deTec product family, implementation into your machine design always remains the same.



Safety – serially, with cascaded modules

+ Implementation of safe presence detection thanks to up to three blind zone-free protective fields adjoining each other.



Uncomplicated integration into safety environments and system environments

+ Easy and perfect integration into compatible safety controllers possible without additional effort.



Reliable against coolants or lubricants

+ Variants with cured glass are also available for use in environments with coolants and lubricants.



Safety in explosive environments

+ Depending on the application, various ex-zones can be created using additional deTec variants.



Safest under high pressure

+ All of our application knowledge has been packed into the protective housing, featuring an enclosure rating of IP69K and providing a high degree of productivity.



Additional variants at → www.sick.com/deTec

THE RIGHT CHOICE FOR EACH PHASE

The deTec product family provides clear advantages in every life cycle phase – beginning with machine or system planning all the way through maintenance. At the same time, high-quality safety services provide the perfect complement to the safety light curtains. The collaboration of hardware and service makes work easier for all personnel involved in each phase, increases productivity in total and creates the basis for sustainable economic activity.



1. Planning and engineering the machine

- + Compact housing saves space
- + Simple machine design due to compatible connectivity
- + Simple integration into all compatible engineering tools such as 3D Models or EPLAN
- + Saving additional sensors by continuing to use the transferred beam data via IO-Link (e.g. for height measurements)

SICK Services

- + Consulting and design: Machine safeguarding evaluation, safety concept, system design



2. Purchasing components

- + The universal light curtain, which can be adapted to the application using the system plug, optimizes storage capacity and eases management of the number of parts.
- + Cost-efficient connecting cables that use conventional connectivity
- + Saving additional sensors by transferring measuring functions

SICK Services

- + Conformity Assessment



3. Machine sales

- + Innovative technologies and new functions for an investment with a future
- + Flexibility thanks to uniform housing design across the entire product family, standardized connectivity and product-specific accessories
- + NFC provides security against remote access, even allowing for use in areas where wireless data communication is not allowed, since data is only sent short distances in the presence of a receiver



4. Structure and mounting

- + The low weight of deTec4 makes mounting easier and reduces the total weight of the machine
- + Reducing costs by using conventional connectivity, foregoing special connecting cables that are difficult to obtain



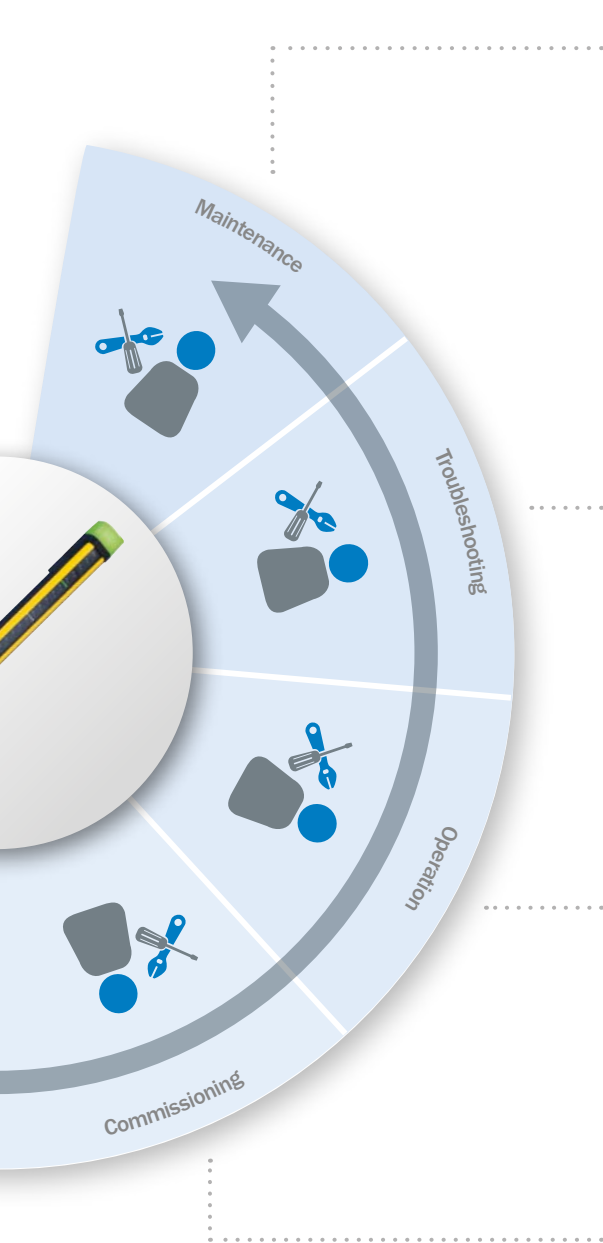

8. Maintenance

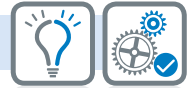

- ⊕ Predictive maintenance using IO-Link data analysis
- ⊕ Easy reading out of the device data using smartphone and NFC technology is also possible without voltage supply
- ⊕ Optimized maintenance option in the app using the signal strength light bar of each beam
- ⊕ Save time and money through the remote maintenance option, such as in retrieving the configuration's security checksum

SICK Services

- ⊕ Maintenance

7. Troubleshooting

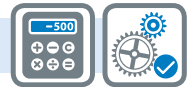

- ⊕ Faster device exchange due to a modular system plug concept
- ⊕ The NFC technology always ensures that only the data from a deTec4 – and not a neighboring deTec4 – will be transmitted to the smart phone
- ⊕ Considerable reduction in machine idle times thanks to quick diagnostics using NFC and smartphones or IO-Link

SICK Services

- ⊕ Troubleshooting on site

6. Operation



- ⊕ Quickly reads the device status using multi-colored diagnostic LEDs
- ⊕ High machine availability with consistently high safety due to innovative functions like the “smart presence detection”

SICK Services

- ⊕ Periodic inspection

5. Commissioning



- ⊕ Saves time by configuring without AF/Notebook
- ⊕ Fast and easy commissioning using the DIP switch assistant in the app
- ⊕ Ready to use quickly through comprehensive alignment assistance

SICK Services

- ⊕ Initial inspection
- ⊕ Stop time measurement

SELECTION GUIDE

Unsure of what deTec safety light curtain is needed?

Simply follow the steps in our online configuration tool at www.sick.com/deTec

- + Simple product selection based on questions
- + Selection of your deTec safety light curtain including accessories
- + Direct transfer to the shopping cart and online order possible

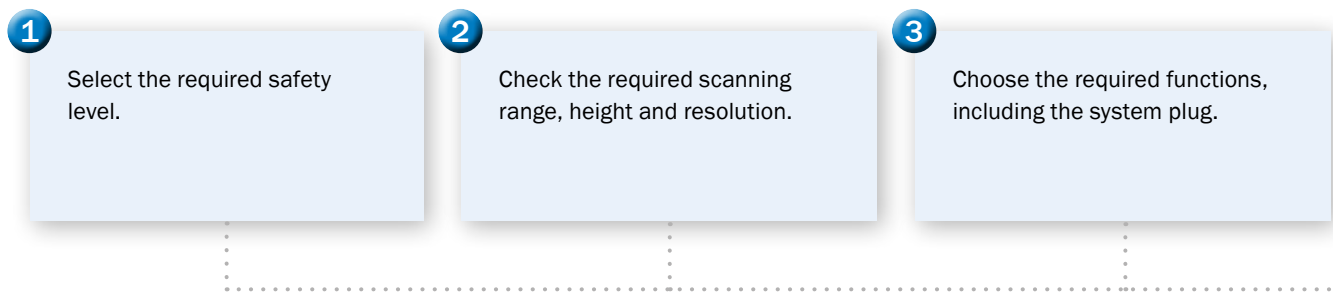
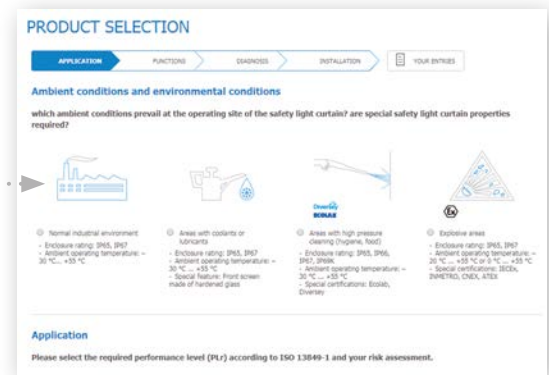

Product	1 Safety-related parameters		2 Features				3 Functions			
	Type 2, PL c, SIL1	Type 4, PL e, SIL3	Typical scanning range	Protective field height	Resolution	Protective operation	Automated scanning range measurement	Beam coding	Restart interlock	
deTec4			≤ 15 m	≤ 30 m	300 mm ... 2,100 mm	14 mm or 30 mm				
	■	■	■	■	■	■	■	■	■	
deTec core										
	■	■	■		■	■	■			

¹⁾ Reduced resolution of 1 or 2 beams.

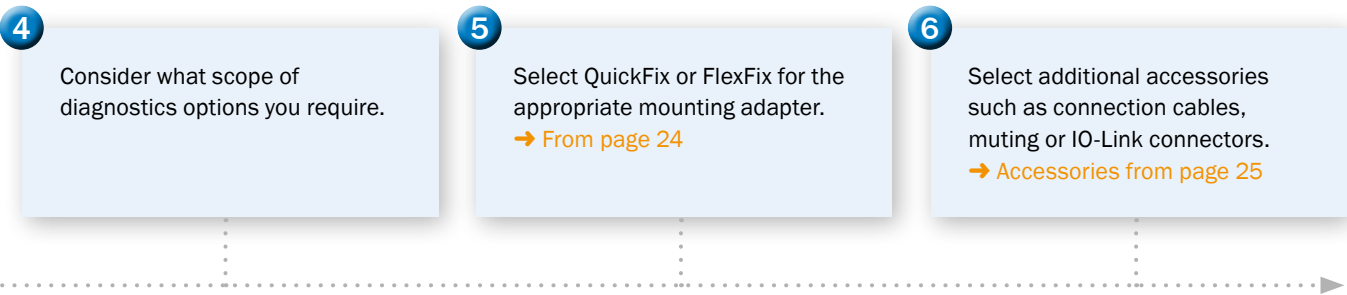

3 Functions								System plug	4 Diagnostics							Page
External device monitoring (EDM)	Cascade	Smart presence detection	Reduced resolution ¹⁾	2-signal muting	Dynamic protective field width in normal operation	Integrated laser alignment aid	SP1	SP2	Alignment quality – LED alignment display	OSSD-Status – ERROR-LED	Field indicator – LED indicator light	NFC	IO-Link	ADO		
■	■					■	■		■	■	■	■	■	■	→ 16	
■	■	■	■	■	■	■		■	■	■	■	■	■	■	→ 16	
							-	-	■	■					→ 20	

SAFE AND INTELLIGENT



Product description

The new generation of deTec safety light curtains is ideal for the protection of hazardous areas, entrances, and hazardous points. Intelligent and state-of-the-art technologies such as NFC and IO-Link offer completely new possibilities for comprehensive diagnosis, fast installation, and performing automation functions. The standardized connectivity and the compatible accessories for

the entire deTec product family reduce variant diversity. The required functions can be activated using the appropriate M12 system plug – without the need for software. With IP65, IP67, and IP69K enclosure ratings available, plus variants for explosion-hazardous areas, solutions can be found for a whole host of different applications in harsh environments.

At a glance

- NFC diagnosis and smartphone app
- Diagnostics and automation via IO-Link
- 2-signal muting
- Smart presence detection
- Dynamic protective field widths
- Configuration of all functions without software
- Reduced resolution: 1 or 2 beams
- IP65, IP67, and IP69K enclosure ratings plus variants for explosion-hazardous areas

Your benefits

- Increased productivity and short downtimes thanks to extensive and innovative diagnostic options
- Safety and automation combined: IO-Link makes cost-effective system design possible
- Muting provides maximum productivity and safety in differentiating between people and material
- High availability: smart presence detection prevents unwanted switch-offs
- Easy commissioning and configuration without the need for software, saving time and money
- IP65, IP67, and IP69K enclosure ratings available, plus variants for explosion-hazardous areas, ensuring maximum reliability in harsh environments



Additional information

Detailed technical data 13
 Ordering information16
 Dimensional drawings 22
 Accessories.....24

→ www.sick.com/deTec

For more information, simply enter the link or scan the QR code and get direct access to technical data, CAD design models, operating instructions, software, application examples, and much more.



Detailed technical data

More detailed data can be found in the operating instructions. Download → www.sick.com

Features

	deTec4		deTec Core	
	Resolution 14 mm	Resolution 30 mm	Resolution 14 mm	Resolution 30 mm
Application	Normal industrial environment			
Protective field height	300 mm ... 2,100 mm (depending on type)			
Scanning range	20 m	30 m	10 m	15 m
No blind zones	Yes			
Synchronization	Optical synchronisation			
Integrated laser alignment aid	✓		-	

Safety-related parameters

	deTec4		deTec Core	
			deTec4 Core	deTec2 Core
Type	Type 4 (IEC 61496-1)		Type 4 (IEC 61496-1)	Type 2 (IEC 61496-1)
Safety integrity level	SIL3 (IEC 61508) SILCL3 (IEC 62061)		SIL3 (IEC 61508) SILCL3 (IEC 62061)	SIL1 (IEC 61508) SILCL1 (IEC 62061)
Category	Category 4 (ISO 13849-1)		Category 4 (ISO 13849-1)	Category 2 (ISO 13849-1)
Performance level	PL e (ISO 13849-1)		PL e (ISO 13849-1)	PL c (ISO 13849-1)
PFH _D (mean probability of a dangerous failure per hour)	Single device	1.53 x 10 ⁻⁸	3.7 x 10 ⁻⁹	3.1 x 10 ⁻⁸
	Cascade with one guest	3.05 x 10 ⁻⁸	-	-
	Cascade with two guest devices	4.56 x 10 ⁻⁸	-	-
T _M (mission time)	20 years (ISO 13849-1)			
Safe state in the event of a fault	At least one OSSD is in the OFF state.			

Functions

	deTec4		deTec Core
	System plug SP1	System plug SP2	
Protective operation	✓		
Automatic calibration of the protective field width	✓		
Beam coding	✓		-
Restart interlock	✓		-
External device monitoring (EDM)	✓		-
Cascading	✓		-
Smart presence detection	-	✓	-
Reduced resolution	-	✓	-
Dynamic protective field width during operation	-	✓	-
Sender with reduced scanning range	-	✓	-
Differentiation between man and material (muting)	-	✓	-

Interfaces

	deTec4	deTec Core
Connection type	System connection	Male connector M12, 5-pin / male connector M12, 8-pin (depending on system plug) ¹⁾
	Extension connection	Female connector M12, 5-pin (depending on system plug) ¹⁾
Configuration method	DIP switch on the system plug	–
Display elements	LEDs	
Display of the synchronization status of the upper and lower beams	✓	–
End cap with integrated LED	✓ (depending on type)	–
Application diagnostic output (ADO)	✓ (depending on system plug) ¹⁾	–
IO-Link	✓ (depending on system plug) ¹⁾	–
Near Field Communication (NFC)	✓	–
Fieldbus, industrial network	Integration via Flexi Soft safety controller	
	CANopen, DeviceNet™, EtherCAT®, EtherNet/IP™, Modbus TCP, PROFIBUS DP, PROFINET ²⁾	

¹⁾ System plugs have to be ordered separately.

²⁾ For additional information on Flexi Soft → www.sick.com/Flexi_Soft.

Electrical data

	deTec4	deTec Core
Protection class	III (IEC 61140)	
Supply voltage V_s	24 V DC (19.2 V ... 28.8 V)	
Ripple	≤ 10 %	
Output signal switching devices (OSSDs)		
Type of output	2 PNP semiconductors, short-circuit protected, cross-circuit monitored ¹⁾	
ON state, switching voltage HIGH	24 V DC ($V_s - 2.25 V \dots V_s$)	
OFF state, switching voltage LOW	≤ 2 V DC	
Current-carrying capacity per OSSD	≤ 500 mA	≤ 300 mA
Diagnostic outputs		
Type of output	PNP semiconductor, short-circuit protected ¹⁾	
Output voltage HIGH (active)	≥ $V_s - 3 V$	–
Output voltage LOW (deactivated)	High resistance	–
Output current HIGH (active)	≤ 100 mA	–

¹⁾ Applies to the voltage range between –30 V and +30 V.

Mechanical data

Dimensions	See dimensional drawing
Housing material	Aluminum extruded profile

Ambient data

Enclosure rating	IP65 (IEC 60529) IP67 (IEC 60529)
Ambient operating temperature	-30 °C ... +55 °C
Storage temperature	-30 °C ... +70 °C
Air humidity	15 % ... 95 %, non-condensing
Vibration resistance	5 g, 10 Hz ... 55 Hz (IEC 60068-2-6)
Shock resistance	10 g, 16 ms (IEC 60068-2-27)

Other information

	deTec4	deTec Core
Wave length	850 nm	
Integrated laser alignment aid	✓	-
Laser class	1	-
Type of light	Visible red light	-
Wave length	650 nm	-

Ordering information

deTec4

A deTec4 safety light curtain consists of:

- Sender
- Receiver
- System plug sender (always SP1)
- System plug receiver (SP1 or SP2) → The receiver system plug defines the available functions of the deTec4.

Selection aid deTec4 system plugs

System plugs for **stand-alone**:

- Sender: SP1
- Receiver: SP1 or SP2 (defines the available functions)

Options:

- System connection 5-pin or 8-pin (e.g. for RES, EDM, ADO, Muting)
- Receiver without or with extension connection (e.g. for RES, EDM, ADO, IO-Link, muting)

System plugs for **host/guest cascade**:

- Host sender: SP1 with extension connection
- Host receiver: SP1 or SP2 (defines the available functions) with extension connection
- Guest sender: SP1 with system connection M12, 5-pin
- Guest receiver: SP1 with system connection M12, 5-pin

Options:

- Host system connection 5-pin or 8-pin (e.g. for RES, EDM, ADO)
- Guest receiver without or with extension connection (e.g. for RES, EDM, ADO, IO-Link)

System plugs for **host/guest/guest cascade**:

- Host sender: SP1 with extension connection
- Host receiver: SP1 or SP2 (defines the available functions) with extension connection
- Guest1 sender: SP1 with system connection M12, 5-pin with extension connection
- Guest1 receiver: SP1 with system connection M12, 5-pin with extension connection
- Guest2 sender: SP1 with system connection M12, 5-pin
- Guest2 receiver: SP1 with system connection M12, 5-pin

Options:

- Host system connection 5-pin or 8-pin (e.g. for RES, EDM, ADO)
- Guest2 receiver without or with extension connection (e.g. for RES, EDM, ADO, IO-Link)

deTec4 system plugs

Functions	Usage	System connection	Extension connection	Type	Part no.
SP1	Sender and receiver	Male connector M12, 5-pin	-	1000	2076832
			Female connector M12, 5-pin (RES, EDM, ADO, IO-Link, cascading)	1100	2076833
		Male connector M12, 8-pin (RES, EDM, ADO)	-	1200	2076834
			Female connector M12, 5-pin (RES, EDM, ADO, IO-Link, cascading)	1300	2076835
SP2	Receiver	Male connector M12, 5-pin	-	2000	2093097
			Female connector M12, 5-pin (RES, EDM, ADO, IO-Link, cascading, smart presence detection, muting)	2100	2093098
		Male connector M12, 8-pin (RES, EDM, ADO, muting)	-	2200	2093099
			Female connector M12, 5-pin (RES, EDM, ADO, IO-Link, cascading, smart presence detection, muting)	2300	2093100

deTec4 sender / receiver without LED indicator lamp

Please note: Scope of delivery without system plug. System plugs have to be ordered separately.

Resolution	Scanning range	Protective field height	Sender		Receiver	
			Type	Part no.	Type	Part no.
14 mm	20 m	300 mm	C4P-SA03011A00	1220084	C4P-EA03011C00	1220097
		450 mm	C4P-SA04511A00	1220085	C4P-EA04511C00	1220098
		600 mm	C4P-SA06011A00	1220086	C4P-EA06011C00	1220099
		750 mm	C4P-SA07511A00	1220087	C4P-EA07511C00	1220100
		900 mm	C4P-SA09011A00	1220088	C4P-EA09011C00	1220101
		1,050 mm	C4P-SA10511A00	1220089	C4P-EA10511C00	1220102
		1,200 mm	C4P-SA12011A00	1220090	C4P-EA12011C00	1220103
		1,350 mm	C4P-SA13511A00	1220091	C4P-EA13511C00	1220104
		1,500 mm	C4P-SA15011A00	1220092	C4P-EA15011C00	1220105
		1,650 mm	C4P-SA16511A00	1220093	C4P-EA16511C00	1220106
		1,800 mm	C4P-SA18011A00	1220094	C4P-EA18011C00	1220121
		1,950 mm	C4P-SA19511A00	1220095	C4P-EA19511C00	1220107
		2,100 mm	C4P-SA21011A00	1220096	C4P-EA21011C00	1220108
30 mm	30 m	300 mm	C4P-SA03031A00	1220123	C4P-EA03031C00	1220137
		450 mm	C4P-SA04531A00	1220124	C4P-EA04531C00	1220138
		600 mm	C4P-SA06031A00	1220125	C4P-EA06031C00	1220139
		750 mm	C4P-SA07531A00	1220126	C4P-EA07531C00	1220140
		900 mm	C4P-SA09031A00	1220127	C4P-EA09031C00	1220141
		1,050 mm	C4P-SA10531A00	1220128	C4P-EA10531C00	1220142
		1,200 mm	C4P-SA12031A00	1220129	C4P-EA12031C00	1220143
		1,350 mm	C4P-SA13531A00	1220130	C4P-EA13531C00	1220144
		1,500 mm	C4P-SA15031A00	1220131	C4P-EA15031C00	1220145
		1,650 mm	C4P-SA16531A00	1220132	C4P-EA16531C00	1220146
		1,800 mm	C4P-SA18031A00	1220134	C4P-EA18031C00	1220147
		1,950 mm	C4P-SA19531A00	1220135	C4P-EA19531C00	1220148
		2,100 mm	C4P-SA21031A00	1220136	C4P-EA21031C00	1220149

deTec4 sender / receiver with integrated LED indicator lamp

Please note: Scope of delivery without system plug. System plugs have to be ordered separately.

- **Special feature on the receiver:** Receiver with integrated LED indicator lamp

Resolution	Scanning range	Protective field height	Sender		Receiver	
			Type	Part no.	Type	Part no.
14 mm	20 m	300 mm	C4P-SA03011A00	1220084	C4P-EA03011D00	1220109
		450 mm	C4P-SA04511A00	1220085	C4P-EA04511D00	1220110
		600 mm	C4P-SA06011A00	1220086	C4P-EA06011D00	1220111
		750 mm	C4P-SA07511A00	1220087	C4P-EA07511D00	1220112
		900 mm	C4P-SA09011A00	1220088	C4P-EA09011D00	1220113
		1,050 mm	C4P-SA10511A00	1220089	C4P-EA10511D00	1220114
		1,200 mm	C4P-SA12011A00	1220090	C4P-EA12011D00	1220115
		1,350 mm	C4P-SA13511A00	1220091	C4P-EA13511D00	1220116
		1,500 mm	C4P-SA15011A00	1220092	C4P-EA15011D00	1220117
		1,650 mm	C4P-SA16511A00	1220093	C4P-EA16511D00	1220118
		1,800 mm	C4P-SA18011A00	1220094	C4P-EA18011D00	1220122
		1,950 mm	C4P-SA19511A00	1220095	C4P-EA19511D00	1220119
		2,100 mm	C4P-SA21011A00	1220096	C4P-EA21011D00	1220120
30 mm	30 m	300 mm	C4P-SA03031A00	1220123	C4P-EA03031D00	1220150
		450 mm	C4P-SA04531A00	1220124	C4P-EA04531D00	1220151
		600 mm	C4P-SA06031A00	1220125	C4P-EA06031D00	1220152
		750 mm	C4P-SA07531A00	1220126	C4P-EA07531D00	1220153
		900 mm	C4P-SA09031A00	1220127	C4P-EA09031D00	1220154
		1,050 mm	C4P-SA10531A00	1220128	C4P-EA10531D00	1220155
		1,200 mm	C4P-SA12031A00	1220129	C4P-EA12031D00	1220156
		1,350 mm	C4P-SA13531A00	1220130	C4P-EA13531D00	1220157
		1,500 mm	C4P-SA15031A00	1220131	C4P-EA15031D00	1220158
		1,650 mm	C4P-SA16531A00	1220132	C4P-EA16531D00	1220159
		1,800 mm	C4P-SA18031A00	1220134	C4P-EA18031D00	1220160
		1,950 mm	C4P-SA19531A00	1220135	C4P-EA19531D00	1220161
		2,100 mm	C4P-SA21031A00	1220136	C4P-EA21031D00	1220162

deTec4 sender with reduced scanning range / receiver without LED indicator lamp

Please note: Scope of delivery without system plug. System plugs have to be ordered separately.

- **Special feature on the sender:** Sender with reduced scanning range to avoid mutual interference between nearby deTec4 safety light curtains

Resolution	Scanning range	Protective field height	Sender		Receiver	
			Type	Part no.	Type	Part no.
14 mm	2,5 m	300 mm	C4P-SA03011C00	1220639	C4P-EA03011C00	1220097
		450 mm	C4P-SA04511C00	1220640	C4P-EA04511C00	1220098
		600 mm	C4P-SA06011C00	1220641	C4P-EA06011C00	1220099
		750 mm	C4P-SA07511C00	1220642	C4P-EA07511C00	1220100
		900 mm	C4P-SA09011C00	1220643	C4P-EA09011C00	1220101
		1,050 mm	C4P-SA10511C00	1220644	C4P-EA10511C00	1220102
		1,200 mm	C4P-SA12011C00	1220645	C4P-EA12011C00	1220103
		1,350 mm	C4P-SA13511C00	1220646	C4P-EA13511C00	1220104
		1,500 mm	C4P-SA15011C00	1220647	C4P-EA15011C00	1220105
		1,650 mm	C4P-SA16511C00	1220648	C4P-EA16511C00	1220106
		1,800 mm	C4P-SA18011C00	1220649	C4P-EA18011C00	1220121
		1,950 mm	C4P-SA19511C00	1220650	C4P-EA19511C00	1220107
2,100 mm	C4P-SA21011C00	1220651	C4P-EA21011C00	1220108		

deTec4 sender with reduced scanning range / receiver with integrated LED indicator lamp

Please note: Scope of delivery without system plug. System plugs have to be ordered separately.

- **Special feature on the sender:** Sender with reduced scanning range to avoid mutual interference between nearby deTec4 safety light curtains
- **Special feature on the receiver:** Receiver with integrated LED indicator lamp

Resolution	Scanning range	Protective field height	Sender		Receiver	
			Type	Part no.	Type	Part no.
14 mm	2,5 m	300 mm	C4P-SA03011C00	1220639	C4P-EA03011D00	1220109
		450 mm	C4P-SA04511C00	1220640	C4P-EA04511D00	1220110
		600 mm	C4P-SA06011C00	1220641	C4P-EA06011D00	1220111
		750 mm	C4P-SA07511C00	1220642	C4P-EA07511D00	1220112
		900 mm	C4P-SA09011C00	1220643	C4P-EA09011D00	1220113
		1,050 mm	C4P-SA10511C00	1220644	C4P-EA10511D00	1220114
		1,200 mm	C4P-SA12011C00	1220645	C4P-EA12011D00	1220115
		1,350 mm	C4P-SA13511C00	1220646	C4P-EA13511D00	1220116
		1,500 mm	C4P-SA15011C00	1220647	C4P-EA15011D00	1220117
		1,650 mm	C4P-SA16511C00	1220648	C4P-EA16511D00	1220118
		1,800 mm	C4P-SA18011C00	1220649	C4P-EA18011D00	1220122
		1,950 mm	C4P-SA19511C00	1220650	C4P-EA19511D00	1220119
2,100 mm	C4P-SA21011C00	1220651	C4P-EA21011D00	1220120		

deTec4 Core

Please note: System connection M12, 5-pin included.

Resolution	Scanning range	Protective field height	Sender		Receiver	
			Type	Part no.	Type	Part no.
14 mm	10 m	300 mm	C4C-SA03010A10000	1211450	C4C-EA03010A10000	1211463
		450 mm	C4C-SA04510A10000	1211469	C4C-EA04510A10000	1211470
		600 mm	C4C-SA06010A10000	1211471	C4C-EA06010A10000	1211472
		750 mm	C4C-SA07510A10000	1211473	C4C-EA07510A10000	1211474
		900 mm	C4C-SA09010A10000	1211475	C4C-EA09010A10000	1211515
		1,050 mm	C4C-SA10510A10000	1211476	C4C-EA10510A10000	1211477
		1,200 mm	C4C-SA12010A10000	1211478	C4C-EA12010A10000	1211479
		1,350 mm	C4C-SA13510A10000	1211480	C4C-EA13510A10000	1211481
		1,500 mm	C4C-SA15010A10000	1211482	C4C-EA15010A10000	1211483
		1,650 mm	C4C-SA16510A10000	1211484	C4C-EA16510A10000	1211485
		1,800 mm	C4C-SA18010A10000	1211486	C4C-EA18010A10000	1211487
		1,950 mm	C4C-SA19510A10000	1211488	C4C-EA19510A10000	1211489
		2,100 mm	C4C-SA21010A10000	1211490	C4C-EA21010A10000	1211491
30 mm	15 m	300 mm	C4C-SA03030A10000	1211462	C4C-EA03030A10000	1211464
		450 mm	C4C-SA04530A10000	1211492	C4C-EA04530A10000	1211493
		600 mm	C4C-SA06030A10000	1211494	C4C-EA06030A10000	1211495
		750 mm	C4C-SA07530A10000	1211496	C4C-EA07530A10000	1211497
		900 mm	C4C-SA09030A10000	1211498	C4C-EA09030A10000	1211516
		1,050 mm	C4C-SA10530A10000	1211499	C4C-EA10530A10000	1211500
		1,200 mm	C4C-SA12030A10000	1211501	C4C-EA12030A10000	1211502
		1,350 mm	C4C-SA13530A10000	1211503	C4C-EA13530A10000	1211504
		1,500 mm	C4C-SA15030A10000	1211505	C4C-EA15030A10000	1211506
		1,650 mm	C4C-SA16530A10000	1211507	C4C-EA16530A10000	1211508
		1,800 mm	C4C-SA18030A10000	1211509	C4C-EA18030A10000	1211510
		1,950 mm	C4C-SA19530A10000	1211511	C4C-EA19530A10000	1211512
		2,100 mm	C4C-SA21030A10000	1211513	C4C-EA21030A10000	1211514

deTec2 Core

Please note: System connection M12, 5-pin included.

Resolution	Scanning range	Protective field height	Sender		Receiver	
			Type	Part no.	Type	Part no.
14 mm	10 m	300 mm	C2C-SA03010A10000	1213163	C2C-EA03010A10000	1213188
		450 mm	C2C-SA04510A10000	1213189	C2C-EA04510A10000	1213190
		600 mm	C2C-SA06010A10000	1213191	C2C-EA06010A10000	1213192
		750 mm	C2C-SA07510A10000	1213193	C2C-EA07510A10000	1213194
		900 mm	C2C-SA09010A10000	1213195	C2C-EA09010A10000	1213196
		1,050 mm	C2C-SA10510A10000	1213197	C2C-EA10510A10000	1213198
		1,200 mm	C2C-SA12010A10000	1213183	C2C-EA12010A10000	1213199
		1,350 mm	C2C-SA13510A10000	1215643	C2C-EA13510A10000	1216120
		1,500 mm	C2C-SA15010A10000	1216121	C2C-EA15010A10000	1216122
		1,650 mm	C2C-SA16510A10000	1216123	C2C-EA16510A10000	1216124
		1,800 mm	C2C-SA18010A10000	1216125	C2C-EA18010A10000	1216126
		1,950 mm	C2C-SA19510A10000	1216127	C2C-EA19510A10000	1216128
		2,100 mm	C2C-SA21010A10000	1216129	C2C-EA21010A10000	1216130
30 mm	15 m	300 mm	C2C-SA03030A10000	1213200	C2C-EA03030A10000	1213184
		450 mm	C2C-SA04530A10000	1213202	C2C-EA04530A10000	1213203
		600 mm	C2C-SA06030A10000	1213204	C2C-EA06030A10000	1213205
		750 mm	C2C-SA07530A10000	1213206	C2C-EA07530A10000	1213207
		900 mm	C2C-SA09030A10000	1213208	C2C-EA09030A10000	1213209
		1,050 mm	C2C-SA10530A10000	1213210	C2C-EA10530A10000	1213211
		1,200 mm	C2C-SA12030A10000	1213212	C2C-EA12030A10000	1213213
		1,350 mm	C2C-SA13530A10000	1213214	C2C-EA13530A10000	1213215
		1,500 mm	C2C-SA15030A10000	1213216	C2C-EA15030A10000	1213217
		1,650 mm	C2C-SA16530A10000	1213218	C2C-EA16530A10000	1213219
		1,800 mm	C2C-SA18030A10000	1213220	C2C-EA18030A10000	1213221
		1,950 mm	C2C-SA19530A10000	1213222	C2C-EA19530A10000	1213223
		2,100 mm	C2C-SA21030A10000	1213201	C2C-EA21030A10000	1213164

Dimensional drawings (Dimensions in mm (inch))

deTec4

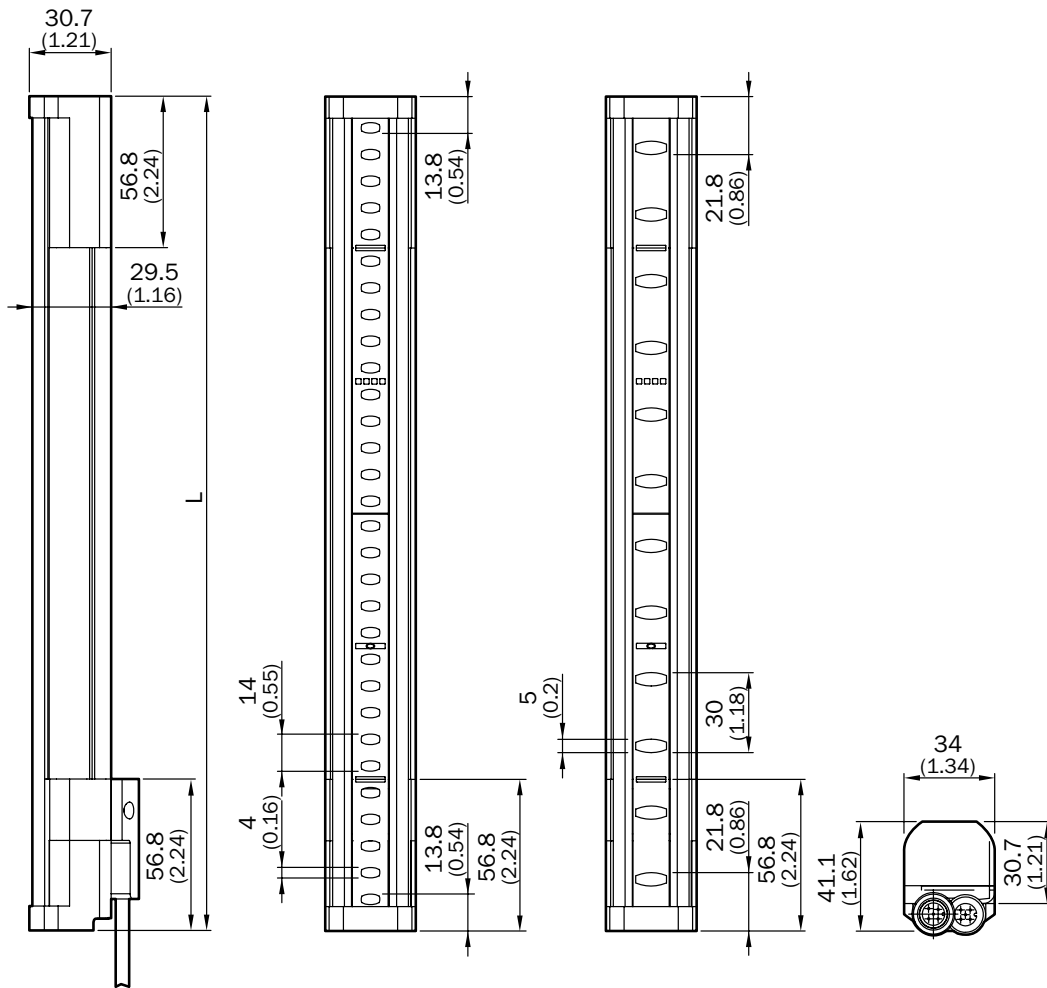

Protective field height	L
300	313
450	463
600	613
750	763
900	913
1,050	1,063
1,200	1,213
1,350	1,362
1,500	1,512
1,650	1,662
1,800	1,812
1,950	1,962
2,100	2112

deTec Core

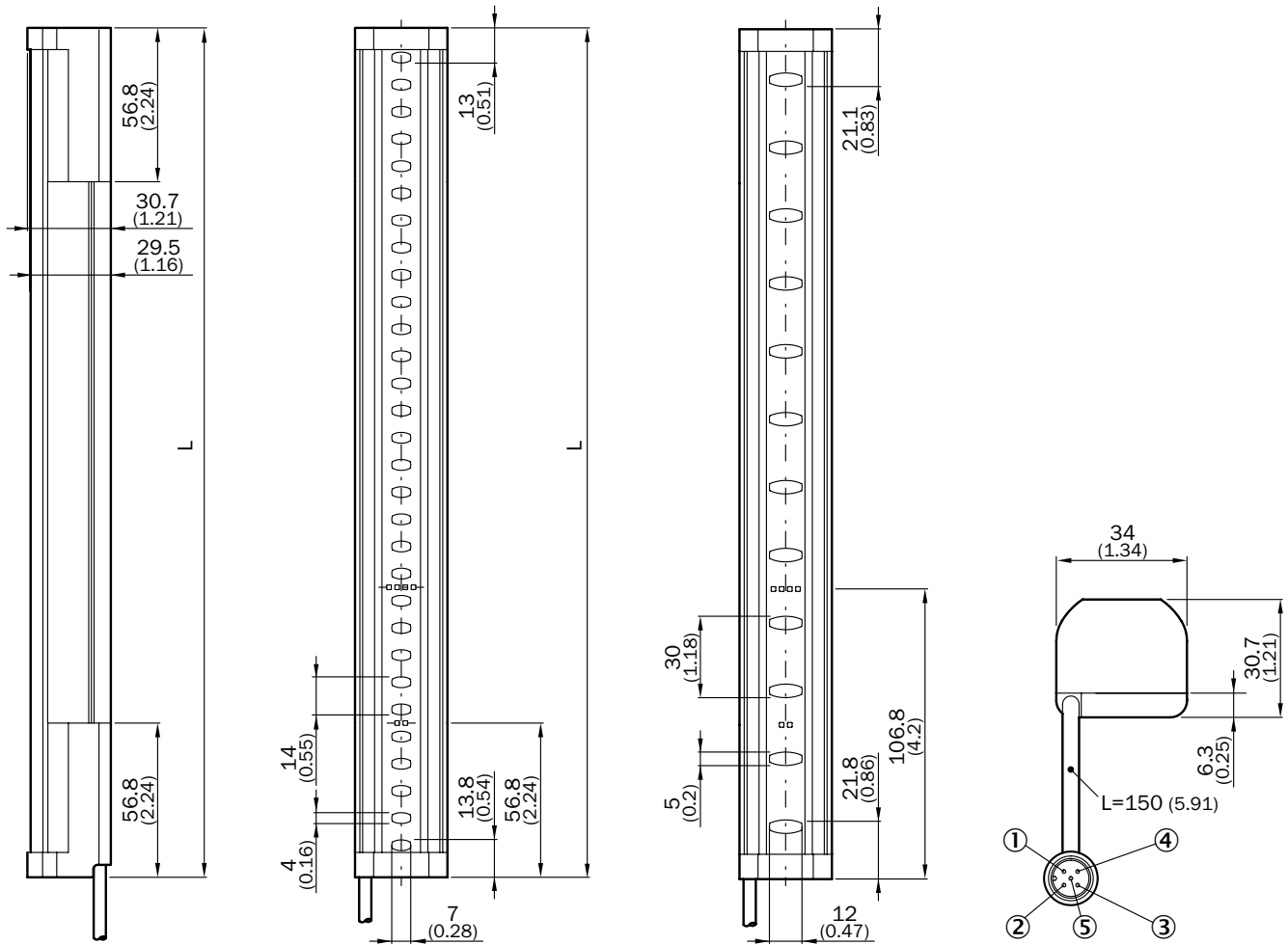





Protective field height	L
300	313
450	463
600	613
750	763
900	913
1,050	1,063
1,200	1,213
1,350	1,362
1,500	1,512
1,650	1,662
1,800	1,812
1,950	1,962
2,100	2112

Accessories

Mounting systems

Terminal and alignment brackets

Figure	Description	Packing unit	Suitable for	Type	Part no.	deTec4	deTecCore
	QuickFix bracket	2 pieces	1 device (sender or receiver)	BEF-3SHABPKU2	2066048	●	●
		4 pieces	2 devices (sender and receiver)	BEF-3SHABPKU4	2098710	●	●
	FlexFix bracket Sensor alignment ± 15° Including screw M5	2 pieces	1 device (sender or receiver)	BEF-1SHABPKU2	2098709	●	●
		4 pieces	2 devices (sender and receiver)	BEF-1SHABPKU4	2066614	●	●
	Mounting kit FlexFix (FlexFix brackets, alignment tool and mounting material suitable for fastening to device columns PU3H)	2 pieces	1 device (sender or receiver)	BEF-1SHABBKU2	2073543	●	●
	FlexFix replacement kit (Mounting kit for replacement of swivel mount brackets 2019649 and 2019659 or side bracket 2019506 with the FlexFix bracket when using the wells provided)	4 pieces	2 devices (sender and receiver)	BEF-1SHABS004	2100345	●	●
	FlexFix replacement kit (Mounting kit for replacement of swivel mount brackets 2030510 or side bracket 2019506 with the FlexFix bracket when using the wells provided)	4 pieces	2 devices (sender and receiver)	BEF-1SHABU004	2099282	●	●

Dimensional drawings → page 30

Mounting tools

Figure	Description	Packing unit	Suitable for	Type	Part no.		
	Alignment tool for sensor alignment in areas with limited accessibility, e.g. device columns PU3H	1 piece	FlexFix bracket	Alignment tool	4084133	●	●

Front screen protection

Figure	Description	Packing unit	Suitable for	Type	Part no.		
	Self-adhesive protective film for the front screen (protects sensors from damage by flying sparks and welding beads)	1 piece	Sufficient for two sensors with a protective field height of 2.100 mm	Self-adhesive protective film	2069268	●	●

Protective caps





Figure	Description	Type	Part no.		
	For a deTec4 sender with extension connection that does not have an additional guest connected to it, the extension connection has no function and must be sealed with a protective cap.	Protective cap, M12 for female connector	5310772	●	-

Connection systems

Plug connectors and cables



Connecting cables

- **Model:** PUR, halogen-free, unshielded

Figure	Connection type		Conductor cross-section	Length of cable	Type	Part no.	deTec4	deTec Core
	Female connector M12, 5-pin, straight	Flying leads	0.34 mm ²	2 m	YF2A15-020UB5XLEAX	2095617	●	●
				5 m	YF2A15-050UB5XLEAX	2095618	●	●
				10 m	YF2A15-100UB5XLEAX	2095619	●	●
				15 m	YF2A15-150UB5XLEAX	2095620	●	●
				20 m	YF2A15-200UB5XLEAX	2095614	●	●
				30 m	YF2A15-300UB5XLEAX	2095621	●	●
	Female connector M12, 5-pin, angled	Flying leads	0.34 mm ²	2 m	YG2A15-020UB5XLEAX	2095772	●	●
				5 m	YG2A15-050UB5XLEAX	2095773	●	●
				10 m	YG2A15-100UB5XLEAX	2095774	●	●
	Female connector M12, 8-pin, straight	Flying leads	0.25 mm ²	2.5 m	YF2A18-025UA5XLEAX	2099229	●	-
				5 m	YF2A18-050UA5XLEAX	2095653	●	-
				7.5 m	YF2A18-075UA5XLEAX	2099230	●	-
				10 m	YF2A18-100UA5XLEAX	2095654	●	-
				15 m	YF2A18-150UA5XLEAX	2095679	●	-
				20 m	YF2A18-200UA5XLEAX	2095680	●	-
				30 m	YF2A18-300UA5XLEAX	2095681	●	-
	Female connector M12, 8-pin, angled	Flying leads	0.25 mm ²	2 m	YG2A18-020UA5XLEAX	2095779	●	-
				5 m	YG2A18-050UA5XLEAX	2095780	●	-
				10 m	YG2A18-100UA5XLEAX	2095781	●	-





Connection cables

- **Model:** PUR, halogen-free, unshielded



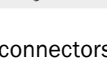

Figure	Connection type		Conductor cross-section	Length of cable	Type	Part no.		
	Female connector M12, 5-pin, straight	Male connector, M12, 5-pin, straight	0.34 mm ²	0.6 m	YF2A15-C60UB5M2A15	2096006	●	●
				1 m	YF2A15-010UB5M2A15	2096007	●	●
				2 m	YF2A15-020UB5M2A15	2096009	●	●
				5 m	YF2A15-050UB5M2A15	2096010	●	●
				10 m	YF2A15-100UB5M2A15	2096011	●	●
				15 m	YF2A15-150UB5M2A15	2096171	●	●
	Female connector M12, 8-pin, straight	Male connector, M12, 8-pin, straight	0.25 mm ²	0.6 m	YF2A18-C60UA5M2A18	2096031	●	-
				1 m	YF2A18-010UA5M2A18	2096032	●	-
				2 m	YF2A18-020UA5M2A18	2096033	●	-
				5 m	YF2A18-050UA5M2A18	2096034	●	-
				10 m	YF2A18-100UA5M2A18	2096035	●	-

Replacement cables (replacement of C4000 with deTec4)



- **Length of cable:** 0,25 m
- **Items supplied:** 2 cables

Figure	Connection type		Model	Conductor cross-section	Type	Part no.	deTec4	deTecCore
	deTec system connection	Replacement C4000						
	Female connector M12, 5-pin, straight	Male connector M12, 8-pin, straight	PVC, unshielded	0.34 mm ²	DSL-1285GM25034KM1	2070987	●	●
		Male connector M26, 12-pin, straight	PVC, unshielded	0.34 mm ²	DSL-6182GM25034KM1	2070989	●	●
		Male connector M26, 7-pin, straight	PVC, unshielded	0.34 mm ²	DSL-6187GM25034KM1	2070988	●	●
	Female connector M12, 8-pin, straight	Male connector, M12, 8-pin, straight	PUR, halogen-free, unshielded	0.25 mm ²	DSL-6108GM25034KM1	2034865	●	-
		Male connector, M26, 12-pin, straight	PUR, halogen-free, unshielded	0.25 mm ²	DSL-6129GM25034KM1	2081442	●	-
		Male connector M26, 7-pin, straight	PUR, halogen-free, unshielded	0.25 mm ²	DSL-6130GM25034KM1	2081443	●	-

T-connectors and pushbuttons

Figure	Description	Type	Part no.		
	T-connector M12, 5-pin For simultaneous connection to sender and receiver. Splits the cable from the control cabinet to the sender and receiver.	DSC-1205T000025KM0	6030664	●	●
	T-connector M12, 8-pin For simultaneous connection to sender and receiver. Splits the cable from the control cabinet to the sender and receiver.	DSC-1208T000025KM0	6058647	●	-
	T-connector with pushbutton for laser alignment aid, M12, 5-pin For simultaneous connection to sender and receiver. Splits the cable from the control cabinet to the sender and receiver. The pushbutton makes it possible to switch on and off the laser alignment aid integrated into the deTec4 Prime sender.	T-connector with pushbutton for laser alignment aid, M12, 5-pin	2077933	●	-
	Pushbutton for laser alignment aid, M12, 5-pin The pushbutton makes it possible to switch on and off the laser alignment aid integrated into the deTec4 Prime sender.	Pushbutton for laser alignment aid, M12, 5-pin	2082166	●	-
	Pushbutton for laser alignment aid, M12, 8-pin The pushbutton makes it possible to switch on and off the laser alignment aid integrated into the deTec4 Prime sender.	Pushbutton for laser alignment aid, M12, 8-pin	2082167	●	-

Connectors



Figure	Description	Type	Part no.		
	The muting connector makes it possible to connect 2 muting sensors and one muting lamp.	Muting connector	2092758	●	-
	The IO-Link connector is used to establish a connection between suitable devices and an IO-Link master, enabling communication via IO-Link. The IO-Link connector can also be used to connect up to 2 muting sensors.	IO-Link connector	2092757	●	-

Power supply units and power supply cables

Figure	Input voltage	Output voltage	Output current	Type	Part no.		
	100 V AC ... 240 V AC	24 V DC	≤ 2.1 A	PS50WE24V	7028789	●	●
			≤ 3.9 A	PS95WE24V	7028790	●	●



Reflectors and optics

Alignment aids

Figure	Description	Type	Part no.		
				deTec4	deTec Core
	Laser alignment aid AR 60, Laser class 2 (IEC 60825). Do not look into the beam!	AR60	1015741	●	●
	Adapter AR60 for deTec, deTem and MLG-2	AR60 adapter, deTec, deTem, MLG-2	4070854	●	●

Deflector mirrors



- **Description:** Horizontal deflection
- **Mirror material:** Glass
- **Items supplied:** Inclusive mounting kit swivel mount
- **Dimensions:** See dimensional drawing

Figure	Mirror width	Mirror height	Suitable for protective field height	Type	Part no.		
	73 mm	340 mm	≤ 300 mm	PNS75-034	1019414	●	●
		490 mm	≤ 450 mm	PNS75-049	1019415	●	●
		640 mm	≤ 600 mm	PNS75-064	1019416	●	●
		790 mm	≤ 750 mm	PNS75-079	1019417	●	●
		940 mm	≤ 900 mm	PNS75-094	1019418	●	●
		1.090 mm	≤ 1.050 mm	PNS75-109	1019419	●	●
		1.240 mm	≤ 1.200 mm	PNS75-124	1019420	●	●
		1.390 mm	≤ 1.350 mm	PNS75-139	1019421	●	●
		1.540 mm	≤ 1.500 mm	PNS75-154	1019422	●	●
		1.690 mm	≤ 1.650 mm	PNS75-169	1019423	●	●
		1.840 mm	≤ 1.800 mm	PNS75-184	1019424	●	●
	123 mm	340 mm	≤ 300 mm	PNS125-034	1019425	●	●
		490 mm	≤ 450 mm	PNS125-049	1019426	●	●
		640 mm	≤ 600 mm	PNS125-064	1019427	●	●
		790 mm	≤ 750 mm	PNS125-079	1019428	●	●
		940 mm	≤ 900 mm	PNS125-094	1019429	●	●
		1.090 mm	≤ 1.050 mm	PNS125-109	1019430	●	●
		1.240 mm	≤ 1.200 mm	PNS125-124	1019431	●	●
		1.390 mm	≤ 1.350 mm	PNS125-139	1019432	●	●
		1.540 mm	≤ 1.500 mm	PNS125-154	1019433	●	●
		1.690 mm	≤ 1.650 mm	PNS125-169	1019434	●	●
		1.840 mm	≤ 1.800 mm	PNS125-184	1019435	●	●
		1.990 mm	≤ 1.950 mm	PNS125-199	1092964	●	●
		2.140 mm	≤ 2.100 mm	PNS125-214	1092965	●	●



Dimensional drawings → [page 31](#)

Further accessories

Test and monitoring tools

Figure	Description	Type	Part no.	deTec4	deTec Core
	14 mm diameter	Test rod 14 mm	2022599	●	●
	24 mm diameter (An effective resolution of 24 mm can be achieved with a physical resolution of 14 mm using the function reduced resolution by 1 beam)	Test rod 24 mm	2045592	●	-
	30 mm diameter	Test rod 30 mm	2022602	●	●
	34 mm diameter (An effective resolution of 34 mm can be achieved with a physical resolution of 14 mm using the function reduced resolution by 2 beams)	Test rod 34 mm	2045593	●	-
	Test rod holder	BEF-3WNAAAAL1	2052249	●	●

Cleaning agent

Figure	Description	Type	Part no.		
	Cloth for cleaning the front screen	Lens cloth	4003353	●	●
	Plastic cleaner and care product, anti-static, 0.5 liter	Plastic cleaner	5600006	●	●

Safety command devices

Reset pushbuttons and multiple pushbuttons

Figure	Description	Items supplied	Type	Part no.		
	Reset pushbutton	Including retaining clip, "RESET" cover and "RESET/OVERRIDE" cover	ER12-SB3C5	6045316	●	-

Mirror columns and device columns

Mirror columns with protective field height mirror

Figure	Suitable for protective field height	Mirror length	Column height	Type	Part no.	deTec4	deTec Core
	≤ 1,050 mm	1,082 mm	1,281.5 mm	PM3C13-00030000	1043453	●	●
	≤ 1,350 mm	1,382 mm	1,569 mm	PM3C15-00030000	1077525	●	●
	≤ 1,500 mm	1,532 mm	1,716.5 mm	PM3C17-00030000	1043454	●	●
	≤ 1,650 mm	1,682 mm	2,016.5 mm	PM3C19-00030000	1043455	●	●
	≤ 1,800 mm	1,832 mm	2,216.5 mm	PM3C20-00030000	1043456	●	●
	≤ 1,950 mm	1,982 mm	2,269 mm	PM3C22-00030000	1093216	●	●
	≤ 2,100 mm	2,132 mm	2,419 mm	PM3C24-00030000	1093217	●	●

Device columns with two external mounting grooves

Figure	Suitable for protective field height: deTec	Max. installation length	Column height	Type	Part no.		
	≤ 900 mm	965 mm	985 mm	PU3H96-00000000	2045490	●	●
	≤ 1,050 mm	1,165 mm	1,185 mm	PU3H11-00000000	2045641	●	●
	≤ 1,200 mm	1,265 mm	1,285 mm	PU3H13-00000000	2045642	●	●
	≤ 1,500 mm	1,550 mm	1,570 mm	PU3H15-00000000	2068813	●	●
	≤ 1,650 mm	1,720 mm	1,740 mm	PU3H17-00000000	2045643	●	●
	≤ 1,950 mm	2,020 mm	2,040 mm	PU3H21-00000000	2045644	●	●
	≤ 2,100 mm	2,250 mm	2,270 mm	PU3H22-00000000	2045645	●	●
2,400 mm		2,420 mm	PU3H24-00000000	2045646	●	●	

Dimensional drawings for accessories (Dimensions in mm (inch))

Terminal and alignment brackets

BEF-1SHABPKU2
 BEF-1SHABPKU4
 BEF-1SHABBKU2

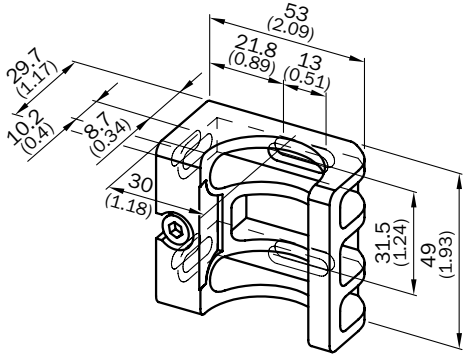

BEF-3SHABPKU2
 BEF-3SHABPKU4

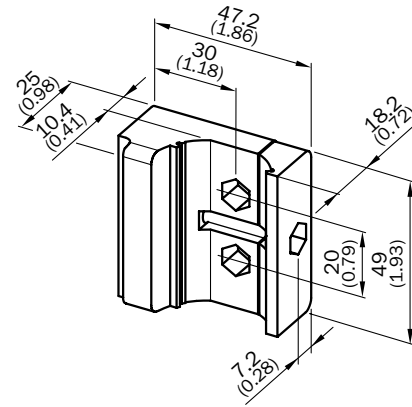

BEF-1SHABP004

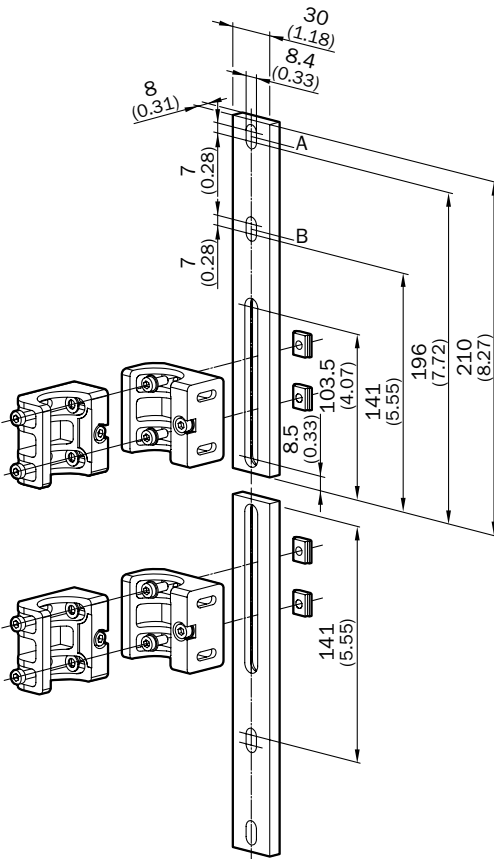

Deflector mirrors

PNS75

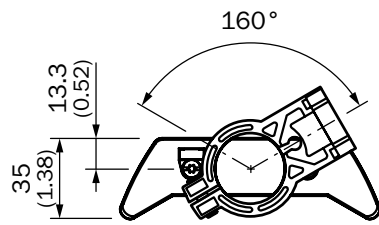

Mounting with
swivel mount bracket
(Part no. 2019659)

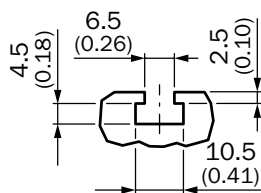

Sliding nut groove for
side mounting

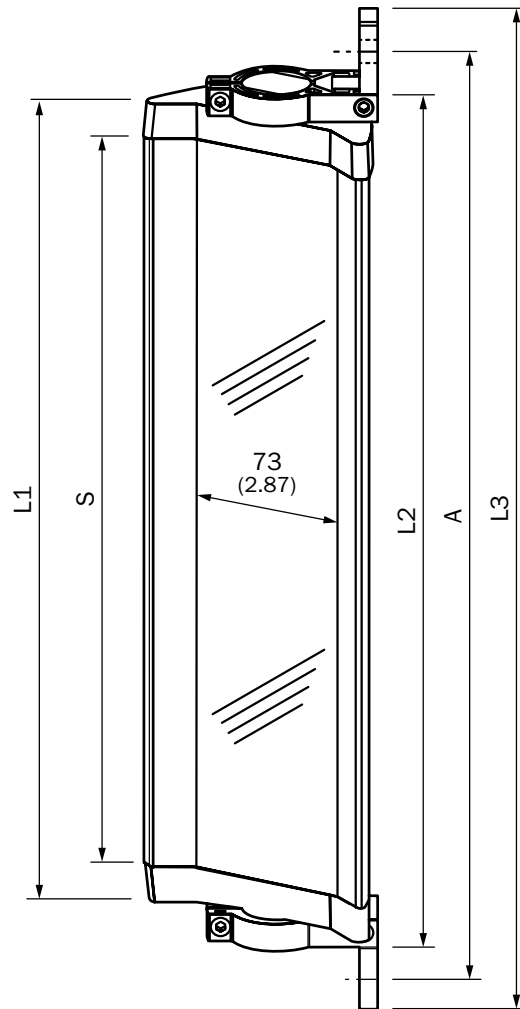
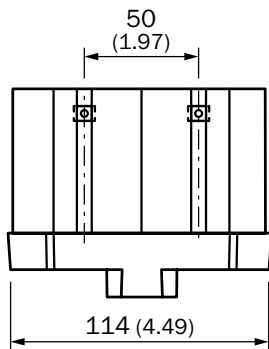

Mirror height S	L1	L2	L3	A
340	372	396	460	440
490	522	546	610	590
640	672	696	760	740
790	822	846	910	890
940	972	996	1,060	1,040
1,090	1,122	1,146	1,210	1,190
1,240	1,272	1,296	1,360	1,340
1,390	1,422	1,446	1,510	1,490
1,540	1,572	1,596	1,660	1,640
1,690	1,722	1,746	1,810	1,790
1,840	1,872	1,896	1,960	1,940
1,990	2,022	2,046	2,110	2,090
2,140	2,172	2,196	2,260	2,240

PNS125

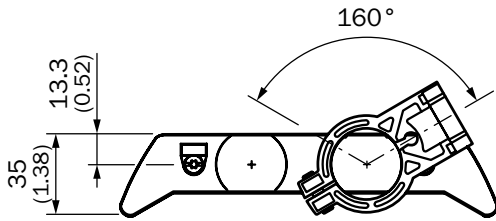

Mounting with
swivel mount bracket
(Part no. 2019659)

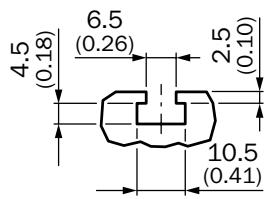

Sliding nut groove for
side mounting

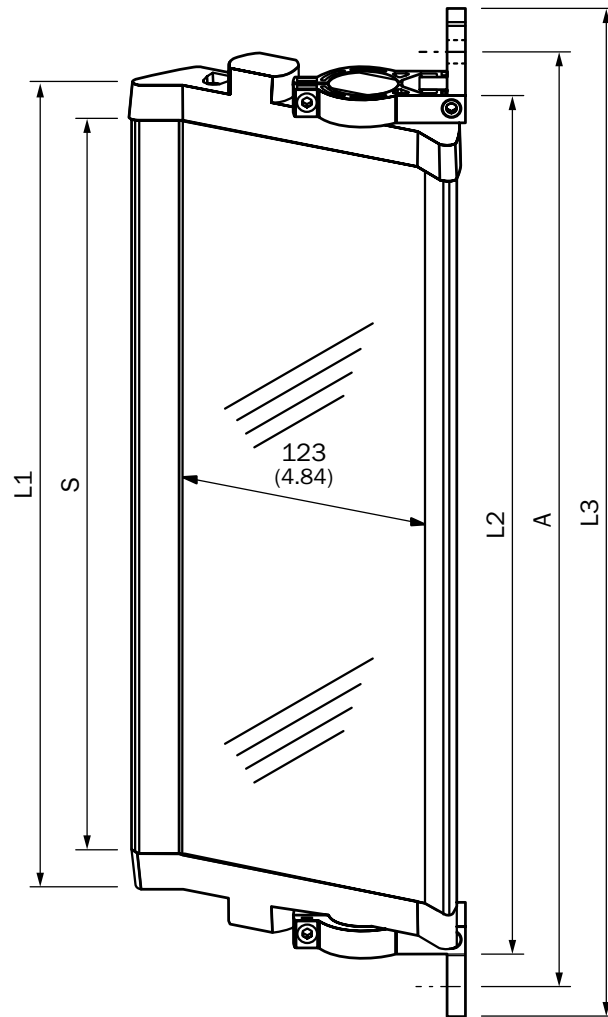
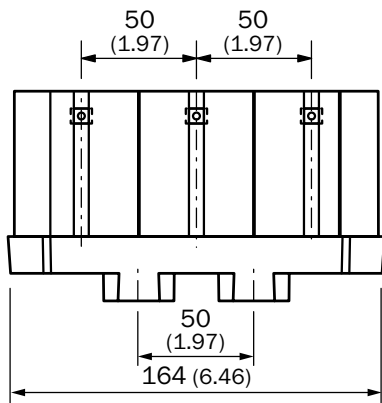

Mirror height S	L1	L2	L3	A
340	372	396	460	440
490	522	546	610	590
640	672	696	760	740
790	822	846	910	890
940	972	996	1,060	1,040
1,090	1,122	1,146	1,210	1,190
1,240	1,272	1,296	1,360	1,340
1,390	1,422	1,446	1,510	1,490
1,540	1,572	1,596	1,660	1,640
1,690	1,722	1,746	1,810	1,790
1,840	1,872	1,896	1,960	1,940
1,990	2,022	2,046	2,110	2,090
2,140	2,172	2,196	2,260	2,240

REGISTER AT WWW.SICK.COM TO TAKE ADVANTAGE OF OUR FOLLOWING SERVICES FOR YOU



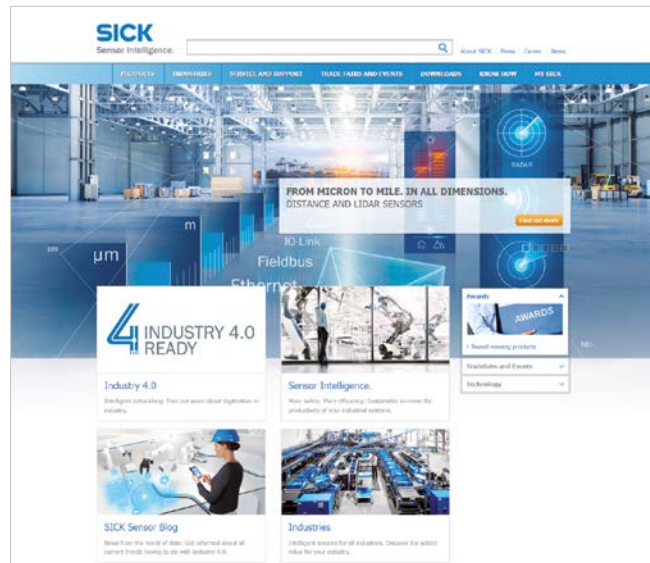

- ✔ Access information on net prices and individual discounts.
- ✔ Easily order online and track your delivery.
- ✔ Check your history of all your orders and quotes.
- ✔ Create, save, and share as many wish lists as you want.
- ✔ Use the direct order to quickly order a big amount of products.
- ✔ Check the status of your orders and quotes and get information on status changes by e-mail.
- ✔ Save time by using past orders.
- ✔ Easily export orders and quotes, suited to your systems.

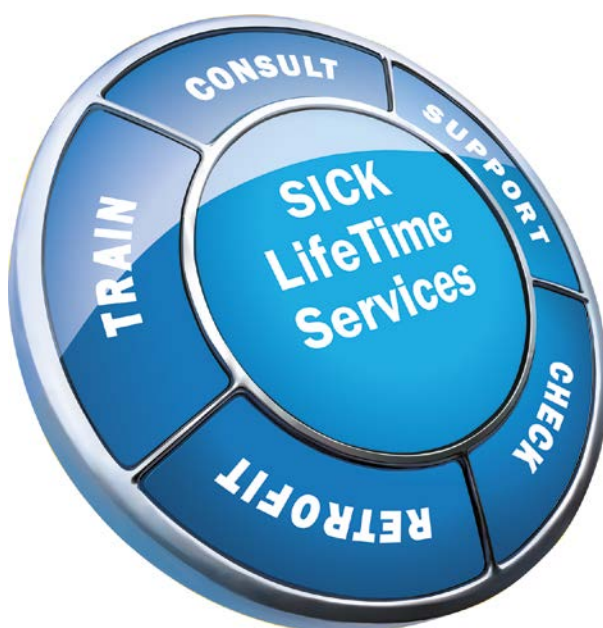

SERVICES FOR MACHINES AND PLANTS: SICK LifeTime Services

Our comprehensive and versatile LifeTime Services are the perfect addition to the comprehensive range of products from SICK. The services range from product-independent consulting to traditional product services.



- 
Consulting and design
 Safe and professional
- 
Product and system support
 Reliable, fast, and on-site
- 
Verification and optimization
 Safe and regularly inspected
- 
Upgrade and retrofits
 Easy, safe, and economical
- 
Training and education
 Practical, focused, and professional

SICK AT A GLANCE

SICK is a leading manufacturer of intelligent sensors and sensor solutions for industrial applications. With more than 8,800 employees and over 50 subsidiaries and equity investments as well as numerous agencies worldwide, SICK is always close to its customers. A unique range of products and services creates the perfect basis for controlling processes securely and efficiently, protecting individuals from accidents, and preventing damage to the environment.

SICK has extensive experience in various industries and understands their processes and requirements. With intelligent sensors, SICK delivers exactly what the customers need. In application centers in Europe, Asia, and North America, system solutions are tested and optimized in accordance with customer specifications. All this makes SICK a reliable supplier and development partner.

Comprehensive services round out the offering: SICK LifeTime Services provide support throughout the machine life cycle and ensure safety and productivity.

That is “Sensor Intelligence.”

Worldwide presence:

Australia, Austria, Belgium, Brazil, Canada, Chile, China, Czech Republic, Denmark, Finland, France, Germany, Great Britain, Hungary, Hong Kong, India, Israel, Italy, Japan, Malaysia, Mexico, Netherlands, New Zealand, Norway, Poland, Romania, Russia, Singapore, Slovakia, Slovenia, South Africa, South Korea, Spain, Sweden, Switzerland, Taiwan, Thailand, Turkey, United Arab Emirates, USA, Vietnam.

Detailed addresses and further locations → www.sick.com