

123B/124B/125B

Industrial ScopeMeter[®]

Calibration Manual

LIMITED WARRANTY AND LIMITATION OF LIABILITY

Each Fluke product is warranted to be free from defects in material and workmanship under normal use and service. The warranty period is three years and begins on the date of shipment. Parts, product repairs, and services are warranted for 90 days. This warranty extends only to the original buyer or end-user customer of a Fluke authorized reseller, and does not apply to fuses, disposable batteries, or to any product which, in Fluke's opinion, has been misused, altered, neglected, contaminated, or damaged by accident or abnormal conditions of operation or handling. Fluke warrants that software will operate substantially in accordance with its functional specifications for 90 days and that it has been properly recorded on non-defective media. Fluke does not warrant that software will be error free or operate without interruption.

Fluke authorized resellers shall extend this warranty on new and unused products to end-user customers only but have no authority to extend a greater or different warranty on behalf of Fluke. Warranty support is available only if product is purchased through a Fluke authorized sales outlet or Buyer has paid the applicable international price. Fluke reserves the right to invoice Buyer for importation costs of repair/replacement parts when product purchased in one country is submitted for repair in another country.

Fluke's warranty obligation is limited, at Fluke's option, to refund of the purchase price, free of charge repair, or replacement of a defective product which is returned to a Fluke authorized service center within the warranty period.

To obtain warranty service, contact your nearest Fluke authorized service center to obtain return authorization information, then send the product to that service center, with a description of the difficulty, postage and insurance prepaid (FOB Destination). Fluke assumes no risk for damage in transit. Following warranty repair, the product will be returned to Buyer, transportation prepaid (FOB Destination). If Fluke determines that failure was caused by neglect, misuse, contamination, alteration, accident, or abnormal condition of operation or handling, including overvoltage failures caused by use outside the product's specified rating, or normal wear and tear of mechanical components, Fluke will provide an estimate of repair costs and obtain authorization before commencing the work. Following repair, the product will be returned to the Buyer transportation prepaid and the Buyer will be billed for the repair and return transportation charges (FOB Shipping Point).

THIS WARRANTY IS BUYER'S SOLE AND EXCLUSIVE REMEDY AND IS IN LIEU OF ALL OTHER WARRANTIES, EXPRESS OR IMPLIED, INCLUDING BUT NOT LIMITED TO ANY IMPLIED WARRANTY OF MERCHANTABILITY OR FITNESS FOR A PARTICULAR PURPOSE. FLUKE SHALL NOT BE LIABLE FOR ANY SPECIAL, INDIRECT, INCIDENTAL OR CONSEQUENTIAL DAMAGES OR LOSSES, INCLUDING LOSS OF DATA, ARISING FROM ANY CAUSE OR THEORY.

Since some countries or states do not allow limitation of the term of an implied warranty, or exclusion or limitation of incidental or consequential damages, the limitations and exclusions of this warranty may not apply to every buyer. If any provision of this Warranty is held invalid or unenforceable by a court or other decision-maker of competent jurisdiction, such holding will not affect the validity or enforceability of any other provision..

Fluke Corporation
P.O. Box 9090
Everett, WA 98206-9090
U.S.A.

Fluke Europe B.V.
P.O. Box 1186
5602 BD Eindhoven
The Netherlands

Table of Contents

Title	Page
Introduction	1
How to Contact Fluke	1
Safety Information	2
Specifications	4
Dual Input Oscilloscope	4
Cursor Readout (124B, 125B)	8
Power Quality (125B)	9
Field Bus Measurements (125B)	9
Miscellaneous	10
Environmental	10
Required Equipment	12
Performance Verification	12
Test Preparation	12
Input A and Input B Tests	13
Input A and Input B Base Line Jump Test	13
Input A Trigger Sensitivity Test	15
Input A Frequency Response Upper Transition Point Test	16
Input A Frequency Measurement Accuracy Test	16
Input B Frequency Measurement Accuracy Test	17
Input B Frequency Response Upper Transition Point Test	18
Input B Trigger Sensitivity Test	18
Input A and Input B Trigger Level and Trigger Slope Test	19
Input A and Input B DC Voltage Accuracy Test	22
Input A and Input B AC Voltage Accuracy Test	24
Input A and Input B AC Input Coupling Test	25
Input A and Input B Volts Peak Measurements Test	25
Input A and B Phase Measurements Test	27
Harmonics Test (125B)	27
Input A and B High Voltage AC/DC Accuracy Test	28
Resistance Measurements Test	30
Continuity Function Test	30
Diode Function Test	31
Capacitance Measurements Test	31
LED, Beeper, LCD, and Front Panel Functional Checks	32
WiFi Functional Check (Version Dependent)	32

Calibration Adjustment	33
Calibration Number and Date	33
Start the Calibration Adjustment	33
Warm Up and Pre-Calibration	34
Final Calibration	34
Delta T Gain, LF- HF Gain Input, Filter, A & B.	34
Position, Input A and B	36
Pulse Adjust Input B	36
Gain DMM (Gain Volt)	37
Diode Zero, Gain	39
Capacitance Clamp and Zero	40
Capacitance Gain	40
Save Calibration Data and Exit	40
Test Tool Disassembly	41
Battery Pack Removal	41
Bail Removal	42
Open the Test Tool	43
Main PCA, Keypad, and Keypad Foil Removal	44
Display Assembly Removal	44
Maintenance	44
How to Clean	44
Storage	44
Battery Replacement	44
Parts and Accessories	45

List of Tables

Table	Title	Page
1.	Symbols	3
2.	Required Equipment	12
3.	Input A, B Frequency Measurement Accuracy Test	16
4.	Volts DC Measurement Verification Points	23
5.	Volts AC Measurement Verification Points	24
6.	Input A and Input B AC Input Coupling Verification Points	25
7.	Volts Peak Verification Points	26
8.	Volts Peak Verification Points	27
9.	V DC and V AC High Voltage Verification Points	29
10.	Resistance Measurement Verification Points	30
11.	Input A and Input B AC Input Coupling Verification Points	31
12.	Screen Messages and Softkey Functions	34
13.	HF Gain Calibration Points Fast	35
14.	HF Gain Calibration Points Slow	36
15.	Volt Gain Calibration Points <300	38
16.	Ohm Gain Calibration Points	39
17.	Capacitance Gain Calibration Points	40
18.	Replacement Parts	45
19.	Optional Accessories	46
20.	Replaceable Parts	46

List of Figures

Figure	Title	Page
1.	Max. Input Voltage vs. Frequency for BB120 and STL120-IV	11
2.	Safe Handling: Max. Voltage Between Test Tool Reference and Earth Ground	11
3.	Test Tool Input A to Calibrator Scope Output 50 Ω	15
4.	Test Tool Input B to Calibrator Scope Output 50 Ω	17
5.	Test Tool Input A-B to Calibrator Scope Output	19
6.	Test Tool Input A-B to Calibrator Normal Output	22
7.	Bargraph Harmonics	28
8.	Test Tool Input A-B to Calibrator Normal Output for >300 V	28
9.	Test Tool Input A to Calibrator Normal Output 4-Wire	30
10.	HF Gain Calibration Input Connections	35
11.	Volt Gain Calibration Input Connections <300 V	37
12.	Four-Wire Ohms Calibration Connections	38
13.	Capacitance Gain Calibration Input Connections	39
14.	Battery Replacement/Charge	42

Introduction

The 123B/124B/125B ScopeMeter® (the Test Tool or Product) is an integrated Test Tool, with oscilloscope, multimeter, and 'paperless' recorder in one easy-to-use instrument.

Warning

To prevent electric shock or personal injury, do not perform the calibration verification tests or calibration procedures described in this manual unless you are qualified to do so. The information provided in this manual is for the use of qualified personnel only.

This manual provides all the information necessary to perform basic maintenance and make calibration adjustments.

For complete operating instructions, refer to the *123B/124B/125B Industrial ScopeMeter® Users Manual* at www.fluke.com.

How to Contact Fluke

To contact Fluke, call one of the following telephone numbers:

- Technical Support USA: 1-800-44-FLUKE (1-800-443-5853)
- Calibration/Repair USA: 1-888-99-FLUKE (1-888-993-5853)
- Canada: 1-800-36-FLUKE (1-800-363-5853)
- Europe: +31 402-675-200
- Japan: +81-3-6714-3114
- Singapore: +65-6799-5566
- Anywhere in the world: +1-425-446-5500

Or, visit Fluke's website at www.fluke.com.

To register your product, visit <http://register.fluke.com>.

To view, print, or download the latest manual supplement, visit <http://us.fluke.com/usen/support/manuals>.

Safety Information

A **Warning** identifies hazardous conditions and procedures that are dangerous to the user. A **Caution** identifies conditions and procedures that can cause damage to the Product or the equipment under test.

Warning













To prevent possible electrical shock, fire, or personal injury:

- Read all safety information before you use the Product.
- Use the Product only as specified, or the protection supplied by the Product can be compromised.
- Carefully read all instructions.
- Do not apply more than one phase of a multiphase system simultaneously to any COM \downarrow (Common) connection. All Common (COM) connections should be equipotential, as marked.
- Remove the batteries if the Product is not used for an extended period of time, or if stored in temperatures above 50 °C. If the batteries are not removed, battery leakage can damage the Product.
- The battery door must be closed and locked before you operate the Product.
- Comply with local and national safety codes. Use personal protective equipment (approved rubber gloves, face protection, and flame-resistant clothes) to prevent shock and arc blast injury where hazardous live conductors are exposed.
- Do not apply more than the rated voltage, between the terminals or between each terminal and earth ground.
- Limit operation to the specified measurement category, voltage, or amperage ratings.
- Use Product-approved measurement category (CAT), voltage, and amperage rated accessories (probes, test leads, and adapters) for all measurements.
- Measure a known voltage first to make sure that the Product operates correctly.
- Use the correct terminals, function, and range for measurements.
- De-energize the circuit or wear personal protective equipment in compliance with local requirements before you apply or remove the flexible current probe from hazardous live conductors.
- Do not touch voltages >30 V ac rms, 42 V ac peak, or 60 V dc.
- Do not use the Product around explosive gas, vapor, or in damp or wet environments.
- Do not use the Product if it operates incorrectly.
- Examine the case before you use the Product. Look for cracks or missing plastic. Carefully look at the insulation around the terminals.
- Do not use test leads if they are damaged. Examine the test leads for damaged insulation, exposed metal, or if the wear indicator shows. Check test lead continuity.
- Use only cables with correct voltage ratings.
- Connect the common test lead before the live test lead and remove the live test lead before the common test lead.
- Keep fingers behind the finger guards on the probes.
- Remove all probes, test leads, and accessories before the battery door is opened.
- Remove all probes, test leads, and accessories that are not necessary for the measurement.

- Do not exceed the Measurement Category (CAT) rating of the lowest rated individual component of a Product, probe, or accessory.
- Do not use a current measurement as an indication that a circuit is safe to touch. A voltage measurement is necessary to know if a circuit is hazardous.
- Disable the Product if it is damaged.
- Do not use the Product if it is damaged.
- Do not use the Product above its rated frequency.
- Do not use the Current Probe if it has damaged insulation, exposed metal, or if the wear indicator is visible.
- Do not wear loose-fitting clothing or jewelry and keep long hair tied back when near rotating machinery. Use approved eye protection and approved personal-protective equipment where necessary.

Symbols used on the Product and in this manual are explained in Table 1.

Table 1. Symbols

Symbol	Description
	Consult user documentation.
	WARNING. RISK OF DANGER.
	WARNING. HAZARDOUS VOLTAGE. Risk of electric shock.
	Earth
	Double Insulated
	Equipotential
	Conforms to relevant South Korean EMC standards.
	Conforms to relevant Australian EMC standards.
	Certified by CSA Group to North American safety standards.
	Conforms to European Union directives.
	Battery Safety Approval
CAT III	Measurement Category III is applicable to test and measuring circuits connected to the distribution part of the building's low-voltage MAINS installation.
CAT IV	Measurement Category IV is applicable to test and measuring circuits connected at the source of the building's low-voltage MAINS installation.
	This product contains a Lithium-ion battery. Do not mix with the solid waste stream. Spent batteries should be disposed of by a qualified recycler or hazardous materials handler per local regulations. Contact your authorized Fluke Service Center for recycling information.
	This product complies with the WEEE Directive marking requirements. The affixed label indicates that you must not discard this electrical/electronic product in domestic household waste. Product Category: With reference to the equipment types in the WEEE Directive Annex I, this product is classed as category 9 "Monitoring and Control Instrumentation" product. Do not dispose of this product as unsorted municipal waste.

Specifications

Dual Input Oscilloscope

Vertical

Frequency Response

DC Coupled

without probes and test leads

(with BB120)

125B, 124B DC to 40 MHz (-3 dB)

123B DC to 20 MHz (-3 dB)

with STL120-IV 1:1 shielded test leads DC to 12.5 MHz (-3 dB) / DC to 20 MHz (-6 dB)

with VP41 10:1 probe

125B, 124B DC to 40 MHz (-3 dB)

123B (optional accessory) DC to 20 MHz (-3 dB)

AC Coupled (LF roll off):

without probes and test leads <10 Hz (-3 dB)

with STL120-IV <10 Hz (-3 dB)

with VP41 10:1 Probe <10 Hz (-3 dB)

Rise Time, excluding probes, test leads

125B, 124B <8.75 ns

123B <17.5 ns

Input Impedance

without probes and test leads 1 M Ω /20 pF

with BB120 1 M Ω /24 pF

with STL120-IV 1 M Ω /230 pF

with VP41 10:1 Probe 5 M Ω /15.5 pF

Sensitivity 5 mV to 200 V/div

Analog Bandwidth Limiter 10 kHz

Display Modes A, -A, B, -B

Max. Input Voltage A and B

direct, with test leads, or with VP41 Probe 600 Vrms Cat IV, 750 Vrms maximum voltage

with BB120 600 Vrms

(For detailed specifications, see Safety, Figure 1 and Figure 2.)

Max. Floating Voltage, from any

terminal to ground 600 Vrms Cat IV, 750 Vrms up to 400 Hz

Vertical Accuracy $\pm(1\% + 0.05 \text{ range/div})$

Max. Vertical Move ± 5 divisions

Horizontal

Scope Modes Normal, Single, Roll

Ranges

Normal

Equivalent sampling

125B, 124B 10 ns to 500 ns/div

123B 20 ns to 500 ns/div

Real time sampling 1 μ s to 5 s/div

Single (real time) 1 μ s to 5 s/div

Roll (real time) 1 s to 60 s/div

Sampling Rate (for both channels simultaneously)

Equivalent sampling (repetitive signals) ≤ 4 GS/s

Real time sampling

1 μ s to 60 s/div 40 MS/s

Time Base Accuracy

Equivalent sampling..... $\pm(0.4 \% + 0.025 \text{ time/div})$
 Real time sampling..... $\pm(0.1 \% + 0.025 \text{ time/div})$

Glitch Detection $\geq 25 \text{ ns @ } 20 \text{ ns to } 60 \text{ s/div}$

Horizontal Move 12 divisions, trigger point can be positioned anywhere across the screen

Trigger

Screen Update Free Run, On Trigger

Source A, B

Sensitivity A and B

@ DC to 5 MHz..... 0.5 divisions or 5 mV

@ 40 MHz

125B, 124B 1.5 divisions

123B..... 4 divisions

@ 60 MHz

125B, 124B 4 divisions

123B..... NA

Slope Positive, Negative

Advanced Scope Functions

Display Modes

Normal Captures up to 25 ns glitches and displays analog-like persistence waveform.

Glitch Off Does not capture glitches between samples.

Smooth..... Suppresses noise from a waveform.

Envelope Records and displays the minimum and maximum of waveforms over time.

Auto Set (Connect-and-View™)

Continuous fully automatic adjustments of amplitude, time base, trigger levels, trigger gap, and hold-off. Manual override by user adjustment of amplitude, time base, or trigger level.

Dual Input Meter

The accuracy of all measurements is within $\pm(\% \text{ of reading} + \text{number of counts})$ from 18 °C to 28 °C.

Add 0.1x (specific accuracy) for each °C below 18 °C or above 28 °C. For voltage measurements with 10:1 probe, add probe uncertainty +1 %. More than one waveform period must be visible on the screen.

Input A and Input B

DC Voltage (VDC)

Ranges..... 500 mV, 5 V, 50 V, 500 V, 750 V

Accuracy..... $\pm(0.5 \% + 5 \text{ counts})$

Normal Mode Rejection (SMR)..... $>60 \text{ dB @ } 50 \text{ Hz or } 60 \text{ Hz } \pm 0.1 \%$

Common Mode Rejection (CMRR) $>100 \text{ dB @ DC}$
 $>60 \text{ dB @ } 50 \text{ Hz, } 60 \text{ Hz, or } 400 \text{ Hz}$

Full Scale Reading..... 5000 counts

True RMS Voltages (VAC and VAC+DC)

Ranges..... 500 mV, 5 V, 50 V, 500 V, 750 V

Accuracy for 5 % to 100 % of range

DC coupled

DC to 60 Hz (VAC+DC) $\pm(1 \% + 10 \text{ counts})$

1 Hz to 60 Hz (VAC) $\pm(1 \% + 10 \text{ counts})$

AC or DC coupled

60 Hz to 20 kHz..... $\pm(2.5 \% + 15 \text{ counts})$

20 kHz to 1 MHz..... $\pm(5 \% + 20 \text{ counts})$

1 MHz to 5 MHz..... $\pm(10 \% + 25 \text{ counts})$

5 MHz to 12.5 MHz..... $\pm(30 \% + 25 \text{ counts})$

5 MHz to 20 MHz
 (without test leads or probes) $\pm(30 \% + 25 \text{ counts})$

AC coupled with 1:1 (shielded) test leads

60 Hz (6 Hz with 10:1 probe)	-1.5 %
50 Hz (5 Hz with 10:1 probe)	-2 %
33 Hz (3.3 Hz with 10:1 probe)	-5 %
10 Hz (1 Hz with 10:1 probe)	-30 %

Note

For the total accuracy for AC coupled, add the derating values specified in the table to the table of AC or DC coupled.

DC Rejection (only VAC).....	>50 dB
Common Mode Rejection (CMRR)	>100 dB @ DC
	>60 dB @ 50 Hz, 60 Hz, or 400 Hz
Full Scale Reading	5000 counts, reading is independent of any signal crest factor.

Peak

Modes	Max peak, Min peak, or pk-to-pk
Ranges.....	500 mV, 5 V, 50 V, 500 V, 2200 V
Accuracy	
Max peak or Min peak.....	5 % of full scale
Peak-to-Peak	10 % of full scale
Full Scale Reading	500 counts

Frequency (Hz)

Ranges	
125B, 124B	1 Hz, 10 Hz, 100 Hz, 1 kHz, 10 kHz, 100 kHz, 1 MHz, 10 MHz, and 70 MHz
123B.....	1 Hz, 10 Hz, 100 Hz, 1 kHz, 10 kHz, 100 kHz, 1 MHz, 10 MHz, and 50 MHz
Frequency Range in Continuous Autoset	15 Hz (1 Hz) to 50 MHz
Accuracy	
125B, 124B	
@ 1 Hz to 1 MHz	$\pm(0.5 \% + 2 \text{ counts})$
@ 1 MHz to 10 MHz.....	$\pm(1.0 \% + 2 \text{ counts})$
@ 10 MHz to 70 MHz.....	$\pm(2.5 \% + 2 \text{ counts})$
123B	
@ 1 Hz to 1 MHz	$\pm(0.5 \% + 2 \text{ counts})$
@ 1 MHz to 10 MHz.....	$\pm(1.0 \% + 2 \text{ counts})$
@ 10 MHz to 50 MHz.....	$\pm(2.5 \% + 2 \text{ counts})$
(50 MHz in Autorange)	
Full Scale Reading	10 000 counts

RPM

Max reading	50.00 kRPM
Accuracy.....	$\pm(0.5 \% + 2 \text{ counts})$

Duty Cycle (PULSE)

Range.....	2 % to 98 %
Frequency Range in Continuous Autoset	15 Hz (1 Hz) to 30 MHz
Accuracy (Logic or Pulse waveforms)	
@ 1Hz to 1 MHz	$\pm(0.5 \% + 2 \text{ counts})$
@ 1 MHz to 10 MHz	$\pm(1.0 \% + 2 \text{ counts})$

Pulse Width (PULSE)

Frequency Range in Continuous Autoset	15 Hz (1 Hz) to 30 MHz
Accuracy (Logic or Pulse waveforms)	
@ 1 Hz to 1 MHz	$\pm(0.5 \% + 2 \text{ counts})$
@ 1 MHz to 10 MHz	$\pm(1.0 \% + 2 \text{ counts})$
Full Scale Reading	1000 counts

Amperes (AMP)

with current clamp	
Ranges.....	same as VDC, VAC, VAC+DC, or PEAK
Scale Factors	0.1 mV/A, 1 mV/A, 10 mV/A, 100 mV/A, 400 mV/A, 1 V/A, 10 mV/mA
Accuracy	same as VDC, VAC, VAC+DC, or PEAK (add current clamp uncertainty)

with iFlex clamp

Ranges.....	20 A/division
Maximum Current	75 A @ 40 Hz to 300 Hz
	Frequency derating: I * F <22 500 A*Hz @ 300 Hz to 3000 Hz
Accuracy	±(1.5 % + 10 counts) @ 40 Hz to 60 Hz
	±(3 % + 15 counts) @ 60 Hz to 1000 Hz
	±(6 % + 15 counts) @ 1000 Hz to 3000 Hz

Temperature (TEMP) with optional temperature probe

Range	200 °C/div (200 °F/div)
Scale Factor.....	1 mV/°C and 1 mV/°F
Accuracy	as VDC (add temp. probe uncertainty)

Decibel (dB)

0 dBV	1 V
0 dBm (600 Ω /50 Ω).....	1 mW referenced to 600 Ω or 50 Ω
dB on.....	VDC, VAC, or VAC+DC
Full Scale Reading.....	1000 counts

Crest Factor (CREST)

Range	1 to 10
Accuracy	±(5 % + 1 count)
Full Scale Reading.....	90 counts

Phase

Modes	A to B, B to A
Range	0 degrees to 359 degrees
Accuracy	
<1 MHz	2 degrees
1 MHz to 5 MHz	5 degrees
Resolution.....	1 degree

Power (125B)

Configurations.....	1 phase / 3 phase 3 conductor balanced loads (3 phase: fundamental component only, AUTOSET mode only)
Power Factor (PF).....	ratio between Watts and VA
Range	0.00 to 1.00
Watt.....	RMS reading of multiplying corresponding samples of input A (volts) and input B (amperes)
Full Scale reading	999 counts
VA	Vrms x Arms
Full Scale Reading.....	999 counts
VA Reactive (VAR)	$\sqrt{((VA)^2 - W^2)}$
Full Scale Reading.....	999 counts

Vpwm

Purpose.....	to measure on pulse width modulated signals, like motor drive inverter outputs
Principle	readings show the effective voltage based on the average value of samples over a whole number of periods of the fundamental frequency
Accuracy	as Vrms for sinewave signals

Input A

Ohm (Ω)

Ranges	
125B.....	50 Ω, 500 Ω, 5 kΩ, 50 kΩ, 500 kΩ, 5 MΩ, 30 MΩ
124B, 123B	500 Ω, 5 kΩ, 50 kΩ, 500 kΩ, 5 MΩ, 30 MΩ
Accuracy	±(0.6 % + 5 counts)
	50 Ω ±(2 % + 20 counts)
Full Scale Reading	
50 Ω to 5 MΩ	5000 counts
30 MΩ	3000 counts
Measurement Current	0.5 mA to 50 nA, decreases with increasing ranges
Open Circuit Voltage.....	<4 V

Continuity (CONT)

Beep.....<(30 Ω \pm 5 Ω) in 50 Ω range
Measurement Current0.5 mA
Detection of shorts 1 ms

Diode

Measurement Voltage
@ 0.5 mA>2.8 V
@ open circuit<4 V
Accuracy..... \pm (2 % + 5 counts)
Measurement Current0.5 mA
Polarity+ on input A, - on COM

Capacitance (CAP)

Ranges.....50 nF, 500 nF, 5 μ F, 50 μ F, 500 μ F
Accuracy \pm (2 % + 10 counts)
Full Scale Reading5000 counts
Measurement Current500 nA to 0.5 mA, increases with increasing ranges

Advanced Meter Functions

Zero Set

Set actual value to reference

Fast/Normal/Smooth

Meter settling time Fast: 1 s @ 1 μ s to 10 ms/div.
Meter settling time Normal: 2 s @ 1 μ s to 10 ms/div.
Meter settling time Smooth: 10 s @ 1 μ s to 10 ms/div.

AutoHold (on A)

Captures and freezes a stable measurement result. Beeps when stable. AutoHold works on the main meter reading, with thresholds of 1 Vpp for AC signals and 100 mV for DC signals.

Fixed Decimal Pointwith attenuation keys

Cursor Readout (124B, 125B)

Sources

A, B

Single Vertical Line

Average, Min and Max Readout
Average, Min, Max and Time from Start of Readout (in ROLL mode, instrument in HOLD)
Min, Max and Time from Start of Readout (in RECORDER mode, instrument in HOLD)
Harmonics values in POWER QUALITY mode.

Dual Vertical Lines

Peak-Peak, Time Distance and Reciprocal Time Distance Readout
Average, Min, Max and Time Distance Readout (in ROLL mode, instrument in HOLD)

Dual Horizontal Lines

High, Low and Peak-Peak Readout

Rise or Fall Time

Transition Time, 0 %-Level and 100 %-Level Readout (Manual or Auto Leveling; Auto Leveling only possible in Single Channel Mode)

Accuracy

As Oscilloscope Accuracy

Recorder

The recorder captures meter readings in Meter Recorder mode or continuously captures waveform samples in Scope Recorder mode. The information is stored on internal memory or on optional SD card (with the 125B or 124B).

The results are displayed as Chart recorder display that plots a graph of min and max values of Meter measurements over time or as a waveform recorder display that plots all the captured samples.

Meter Readings

Measurement Speed.....	maximum 2 measurements/s
Record Size	2 M readings for 1 channel (400 MB)
Recorded Time Span	2 weeks
Maximum number of events.....	1024

Waveform record

Maximum sample rate.....	400 K sample/s
Record Size Internal memory	400 M samples
Recorded Time Span internal memory	15 minutes at 500 μ s/div 11 hours at 20 ms/div

125B, 124B

Record Size SD card	15 G samples
Recorded Time Span SD card	11 hours at 500 μ s/div 14 days at 20 ms/div
Maximum number of events.....	64 events on 1 channel

Power Quality (125B)

Readings Watt, VA, VAR, PF, DPF, Hz

Watt, VA, var ranges (auto) 250 W to 250 MW, 625 MW, 1.56 GW

when selected: total (%) $\pm(2\% + 6 \text{ counts})$

when selected: fundamental (%)..... $\pm(4\% + 4 \text{ counts})$

DPF 0.00 to 1.00

0.00 to 0.25 not specified

0.25 to 0.90 ± 0.04

0.90 to 1.00 ± 0.03

PF 0.00 to 1.00, ± 0.04

Frequency range 10.0 Hz to 15.0 kHz
40.0 Hz to 70.0 Hz $\pm(0.5\% + 2 \text{ counts})$

Number of Harmonics DC to 51

Readings / Cursor readings (fundamental 40 Hz to 70 Hz)

V rms / A rms fund. $\pm(3\% + 2 \text{ counts})$ 31st $\pm(5\% + 3 \text{ counts})$, 51st $\pm(15\% + 5 \text{ counts})$

Watt..... fund. $\pm(5\% + 10 \text{ counts})$ 31st $\pm(10\% + 10 \text{ counts})$, 51st $\pm(30\% + 5 \text{ counts})$

Frequency of fundamental $\pm 0.25 \text{ Hz}$

Phase Angle..... fund. $\pm 3^\circ$ to 51st $\pm 15^\circ$

K-factor (in Amp and Watt) $\pm 10\%$

Field Bus Measurements (125B)

Type	Subtype	Protocol
AS-i		NEN-EN50295
CAN		ISO-11898
Interbus S	RS-422	EIA-422
Modbus	RS-232	RS-232/EIA-232
	RS-485	RS-485/EIA-485
Foundation Fieldbus	H1	61158 type 1, 31.25 kBit
Profibus	DP	EIA-485
	PA	61158 type 1
RS-232		EIA-232
RS-485		EIA-485

Miscellaneous

Display

Type	5.7-inch color active matrix TFT
Resolution	640 pixels x 480 pixels
Waveform Display	
Vertical	10 div of 40 pixels
Horizontal	12 div of 40 pixels

Power

External	via Power Adapter BC430/820
Input Voltage	15 V dc to 22 V dc
Power	4.1 W typical
Input Connector	5 mm jack
Internal	via Battery Pack BP290
Battery Power	Rechargeable Li-Ion 10.8 V
Operating Time	7 hours with 50 % backlight brightness
Charging Time	4 hours with Test Tool off, 7 hours with Test Tool on
Allowable ambient temperature	0 °C to 40 °C (32 °F to 104 °F) during charging

Memory

Number of internal Data set Memories	20 data sets (each consists of screen, waveforms and setup)
SD card slot with optional SD card with max size	32 GB for recording, 20 memory locations for saving data sets

Mechanical

Size	259 mm x 132 mm x 55 mm (10.2 in x 5.2 in x 2.15 in)
Weight	1.4 kg (3.1 lb) including battery pack

Interface

Optically isolated USB to PC/laptop	Transfer screen dumps (bitmaps), settings and data using OC4USB optically isolated USB adapter/cable, (optional), using FlukeView® ScopeMeter® software for Windows®.
Optional WiFi Adapter	Fast transfer of screen dumps (bitmaps), settings and data to PC/laptop, tablet, smartphone, etc. A USB port is provided for attaching the WiFi Adapter. Do not use the USB port with a cable for safety reasons.

Environmental

Environmental

MIL-PRF-28800F, Class 2

Temperature

Operating and charging	0 °C to 40 °C (32 °F to 104 °F)
Operating	0 °C to 50 °C (32 °F to 122 °F)
Storage	-20 °C to 60 °C (-4 °F to 140 °F)

Humidity

Operating	
@ 0 °C to 10 °C (32 °F to 50 °F)	noncondensing
@ 10 °C to 30 °C (50 °F to 86 °F)	95 %
@ 30 °C to 40 °C (86 °F to 104 °F)	75 %
@ 40 °C to 50 °C (104 °F to 122 °F)	45 %

Storage	
@ -20 °C to 60 °C (-4 °F to 140 °F)	noncondensing

Altitude

Operating CAT III 600 V	3 km (10 000 feet)
Operating CAT IV 600 V	2 km (6600 feet)
Storage	12 km (40 000 feet)

Vibration

MIL-PRF-28800F, Class 2

Shock

30 g maximum

Electromagnetic Compatibility (EMC)

- International IEC 61326-1: Industrial
CISPR 11: Group 1, Class A
Group 1: Equipment has intentionally generated and/or uses conductively-coupled radio frequency energy that is necessary for the internal function of the equipment itself.
Class A: Equipment is suitable for use in all establishments other than domestic and those directly connected to a low-voltage power supply network that supplies buildings used for domestic purposes. There may be potential difficulties in ensuring electromagnetic compatibility in other environments due to conducted and radiated disturbances.
Emissions that exceed the levels required by CISPR 11 can occur when the equipment is connected to a test object.
- Korea (KCC) Class A Equipment (Industrial Broadcasting & Communication Equipment)
Class A: Equipment meets requirements for industrial electromagnetic wave equipment and the seller or user should take notice of it. This equipment is intended for use in business environments and not to be used in homes.
- USA (FCC) 47 CFR 15 subpart B. This product is considered an exempt device per clause 15.103.

Wireless Radio with Adapter

- Frequency Range 2412 MHz to 2462 MHz
- Output Power <100 mW

Enclosure Protection IP51, ref: EN/IEC60529

Safety

- General IEC 61010-1: Pollution Degree 2
- Measurement IEC 61010-2-033: CAT IV 600 V / CAT III 750 V

Max. Input Voltage Input A and B

- Direct on input or with leads 600 Vrms CAT IV for derating, see Figure 1.
- With Banana-to BNC Adapter BB120 600 Vrms for derating, see Figure 2.

Max. Floating Voltage

from any terminal to ground 600 Vrms Cat IV, 750 Vrms up to 400 Hz

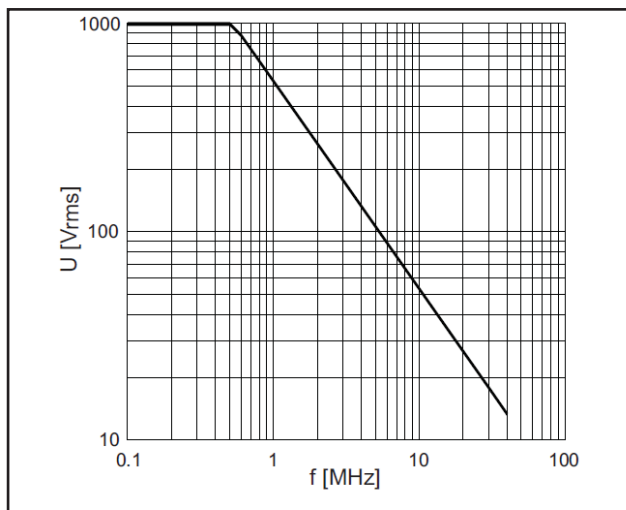

Figure 1. Max. Input Voltage vs. Frequency for BB120 and STL120-IV

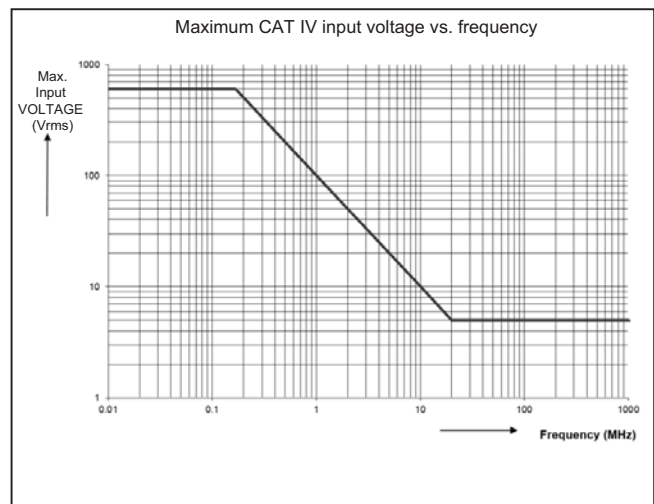

Figure 2. Safe Handling: Max. Voltage Between Test Tool Reference and Earth Ground

The Fluke 12xB series, including standard accessories, conforms to the EEC directive 2004/108/EC for EMC immunity, as defined by EN61326-1: 2006, with the addition of the table below.

Trace disturbance with STL120-IV

Frequency	Field strength	No visible disturbance	Disturbance less than 10 % of full scale
80 MHz to 1 GHz	10 V/m	1 V/div to 200 V/div	500 mV/div
1.4 GHz to 2 GHz	3 V/m	All ranges	-
2 GHz to 2.7 GHz	1 V/m	All ranges	-

(-) = no visible disturbance

Ranges not specified may have a disturbance of >10 % of full scale.

Required Equipment

Before you start the verification procedures or make calibration adjustments, refer to this section for the equipment, system, and setup requirements.

See Table 2 for a list of requirements for the verification tests and calibration adjustment of the Logger.

Table 2. Required Equipment

Equipment	Model	Notes	Used on:	
			Verification Tests	Calibration Adjustment
Calibrator	5502A	5520A is also supported (shown in illustrations)	X	X
Stackable Test Leads (4x), supplied with the 5500A.			X	X
50 Ω Coax Cables (2x)	PM9091 (1.5 m) or PM9092 (0.5 m)		X	X
50 Ω feed through terminations (2x)	PM9585/TRM50		X	X
Shielded Banana to Female BNC adapters (2x)	BB120-II		X	X
Dual Banana Plug to Female BNC Adapter (1x)	PM9081/001		X	X
Dual Banana Jack to Male BNC Adapter (1x)	PM9082/001		X	
Male BNC to Dual Female BNC Adapter	PM9093/001		X	X

Performance Verification

Warning

Procedures in this chapter should be performed by qualified service personnel only. To avoid electrical shock, do not perform any servicing unless you are qualified to do so.

The Test Tool is calibrated and in operating condition when you receive it. Use these performance tests to ensure that the Test Tool is in good operating condition. If the Test Tool fails any of the performance tests, calibration adjustment and/or repair is necessary.

The Performance Verification Procedure is a quick way to check most of the Test Tool's specifications. Because of the highly integrated design of the Test Tool, it is not always necessary to check all features separately. For example: the duty cycle, pulse width, and frequency measurement are based on the same measurement principles. You need to only verify one of these functions.

The Performance Verification Procedure is based on the specifications. See page 4. The values given here are valid for ambient temperatures between 18 °C and 28 °C.

Verification procedures are listed below. The test requirements are listed for each feature. If the result of the test does not meet the requirements, the Test Tool should be recalibrated or repaired if necessary. Some of the tests vary because the 124B and 125B have higher vertical and trigger bandwidths than the 123B. The 125B can also measure more values, and it operates differently. The requirements for each Test Tool are clearly indicated.

Test Preparation

For all tests:

1. Turn on the Test Tool with the BC430 power adapter. A charged battery pack must be installed.
2. Allow the Test Tool to warm up for 20 minutes.
3. Allow the Calibrator to warm up. See the Calibrator Operators Manual.
4. For each test point, wait for the Calibrator to become stable.
5. After each test, set the Calibrator to Standby.

Input A and Input B Tests

To verify a measurement, choose items from the menus.

To choose an item from a menu:

1. Push **MENU**.
2. Use **▲▼** to highlight a selection in the menu.
3. Push **ENTER** to confirm the selection and go to the next item group (if present).

Item groups in a menu are separated by a vertical line.

Before you start the Input A and Input B tests:

1. Go to the **USER OPTIONS** menu.
2. Push **ENTER** to open the options list.
3. Select **Factory Default** and push **ENTER**.

The Test Tool is set to the Factory Default setup.

For most tests, you must turn on Input B. Input A is always on.

To Turn on Input B:

1. Push the B button (mV – V).
If B is off, the option to turn on B (**F4** on / **F3** off) shows on the display.
2. Push **F4**.

For most tests, you must push **AUTO** to select auto ranging. In auto ranging mode, Auto shows on the display of the Test Tool. **AUTO** toggles between Auto and Manual ranging.

For some tests, you need to adjust the amplitude of the sine wave on the display.

Input A and Input B Base Line Jump Test

To check the Input A and Input B base line jump:

1. Use the BB120 banana to BNC adapter, and a 50 Ω (or lower) BNC termination to short circuit the Input A and the Input B shielded banana sockets of the Test Tool.
2. Set up the Test Tool:
 - a. Turn on Input B if necessary.
 - b. Push **AUTO** to select auto ranging (AUTO shows at the top of the display).

Note

AUTO toggles between AUTO and MANUAL ranging.

- c. Push **SCOPE METER**.
- d. Push **F3** to open the INPUT SETTINGS A menu (inputs default to A) and make these selections:
 - Coupling: **DC**
 - Readings: **Normal**
 - Noise filter: **ON**

- e. To set Input B, push **F2** and make these selections:
- Coupling: **DC**
 - Readings: **Normal**
 - Noise filter: **ON**

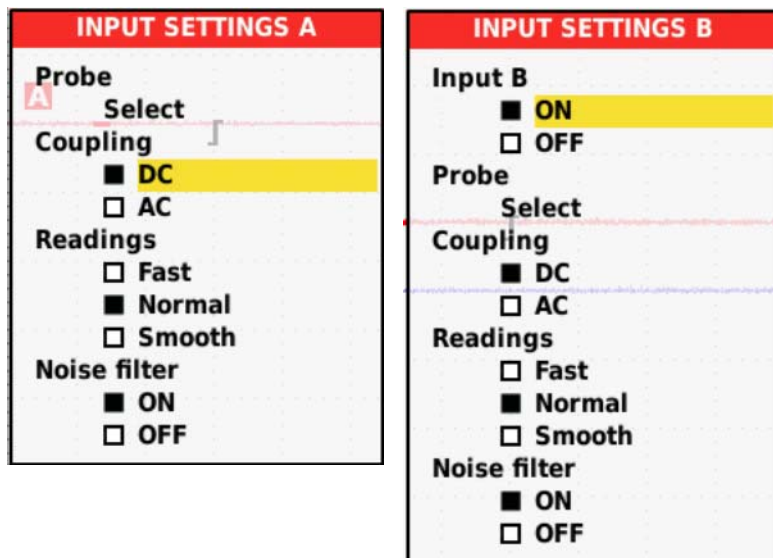

3. On the Test Tool, push **TIME_{ns}** to toggle the time base between 10 ms/div and 5 ms/div. The time base ranging is set to manual. The input sensitivity is automatic. Neither AUTO nor MANUAL show on the display.
4. After the time base changes, wait a few seconds for the trace to become stable.
5. Make sure the Input A trace returns to the same position after the time base changes. The allowed difference is ± 0.025 division (= 1 pixel).
6. Repeat step 5 for the Input B trace.
7. Push **TIME_{us}** to toggle the time base between 1 μ s/div and 500 ns/div.
8. After the time base changes, wait a few seconds for the trace to become stable.
9. Make sure the Input B trace returns to the same position after the time base changes. The allowed difference is ± 0.025 division (= 1 pixel).
10. Remove the Input A and Input B short.

Input A Trigger Sensitivity Test

To test the Input A trigger sensitivity:

1. Connect the Test Tool to the Calibrator. See Figure 3.

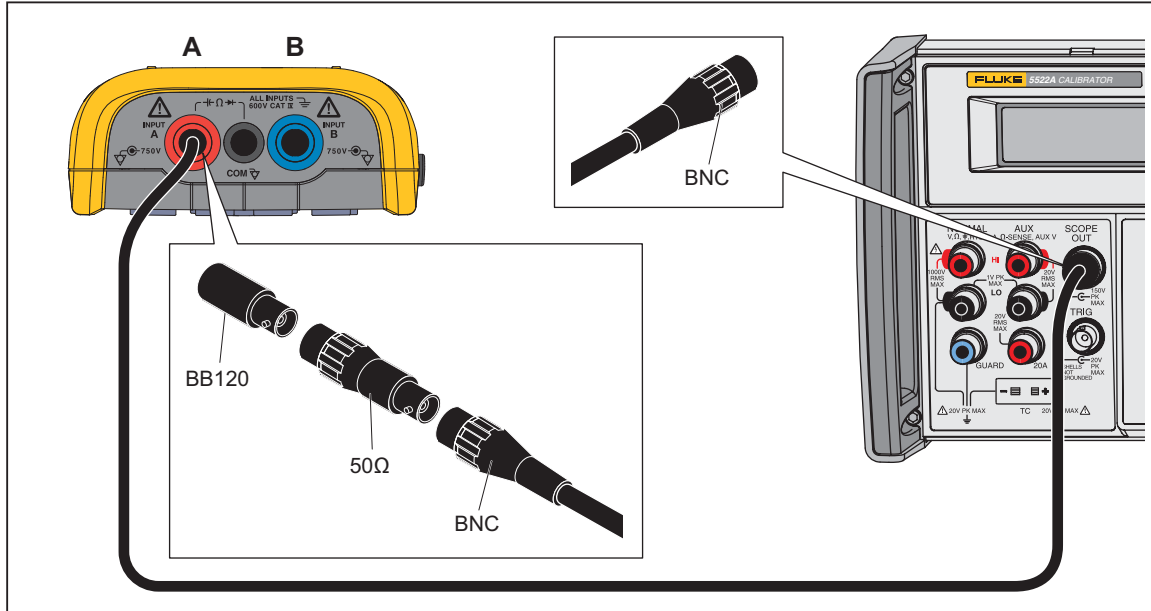

Figure 3. Test Tool Input A to Calibrator Scope Output 50 Ω

2. Set up the Test Tool:
 - a. Push **AUTO** if AUTO does not show in the center of the top row on the display.

Note
For this procedure, do not push **TIME**.

 - b. Push **mV** or **V** to change the sensitivity, to select manual sensitivity ranging, and to lock the Input A sensitivity on 200 mV/div.
3. Set up the Calibrator:
 - a. Supply a 5 MHz leveled sine wave of 100 mV peak-to-peak (SCOPE output, MODE levsine).
 - b. Push **OPR**.
4. Adjust the amplitude of the sine wave to 0.5 division.
 - a. Verify that the signal is well triggered. If it is not, press **F2** to enable **▲▼** for Trigger Level adjustment.
 - b. Use **▲▼** to adjust the trigger level and verify that the signal is triggered.
The trigger icon (⌋) indicates the trigger level.
5. On the Calibrator, supply a 25 MHz (123B) or 40 MHz (124B/125B) leveled sine wave of 400 mV peak-to-peak.
6. Adjust the amplitude of the sine wave to 1.5 divisions.
 - a. Verify that the signal is well triggered. If it is not, press **F2** to enable **▲▼** for Trigger Level adjustment.
 - b. Use **▲▼** to adjust the trigger level and verify that the signal is triggered.
7. On the Calibrator, supply a 40 MHz (123B) or 60 MHz (124B/125B) leveled sine wave of 1.8 V peak-to-peak.
8. Adjust the amplitude of the sine wave to 4 divisions.
 - a. Verify that the signal is well triggered. If it is not, press **F2** to enable **▲▼** for Trigger Level adjustment.
 - b. Use **▲▼** to adjust the trigger level and verify that the signal is triggered.

Input A Frequency Response Upper Transition Point Test

To test the Input A frequency response upper transition point:

1. Connect the Test Tool to the Calibrator. See Figure 3.
2. Set up the Test Tool:
 - a. Push **AUTO** to select auto ranging (AUTO shows at the top of the display).

Note

*For this procedure, do not push **TIME**.*

- b. Push **mV** or **V** to change the sensitivity, to select manual sensitivity ranging, and to lock the Input A sensitivity on 200 mV/div.
3. Set up the Calibrator:
 - a. Supply a leveled sine wave of 1.2 V peak-to-peak, 50 kHz (SCOPE output, MODE levsine).
 - b. Push **OPR**.
4. Adjust the amplitude of the sine wave to 6 divisions.
5. On the Calibrator, supply 20 MHz (123B) or 40 MHz (124B/125B), but do not change the amplitude.
6. Make sure that the Input A trace is ≥ 4.2 divisions.

Note

The lower transition point is tested in Input A and Input B AC Input Coupling Test on page 25.

Input A Frequency Measurement Accuracy Test

To test the Input A frequency measurement accuracy:

1. Connect the Test Tool to the Calibrator. See Figure 3.
2. Set up the Test Tool:
 - a. Push **AUTO** to select auto ranging (AUTO shows at the top of the display).
 - b. Push **SCOPE METER**.
 - c. Push **F1** to open the INPUT A MEASUREMENTS menu.
 - d. Select **Hz**.
 - e. Push **ENTER** twice to close the menu.
3. Set up the Calibrator:
 - a. Supply a leveled sine wave of 1 MHz @ 600 mV peak-to-peak (SCOPE output, MODE levsine).
 - b. Push **OPR**.
4. For each Output in Table 3:
 - a. On the Calibrator, supply the frequency listed. Start with 1 MHz.
 - b. Compare the Input A main reading on the Test Tool with the reading range listed in Table 3.

Table 3. Input A, B Frequency Measurement Accuracy Test

Calibrator output, 600 mVpp	Input A, B Reading
1 MHz	0.993 MHz to 1.007 MHz
10 MHz	09.88 MHz to 10.12 MHz
40 MHz	38.98 MHz to 41.02 MHz
60 MHz (124B/125B only)	58.48 MHz to 61.52 MHz

Note

Because the Duty Cycle and Pulse Width measurements are based on the same principles as Frequency measurements, the Duty Cycle and Pulse Width measurement function are not verified separately.

Input B Frequency Measurement Accuracy Test

To test the Input B frequency measurement accuracy:

1. Connect the Test Tool to the Calibrator. See Figure 4.

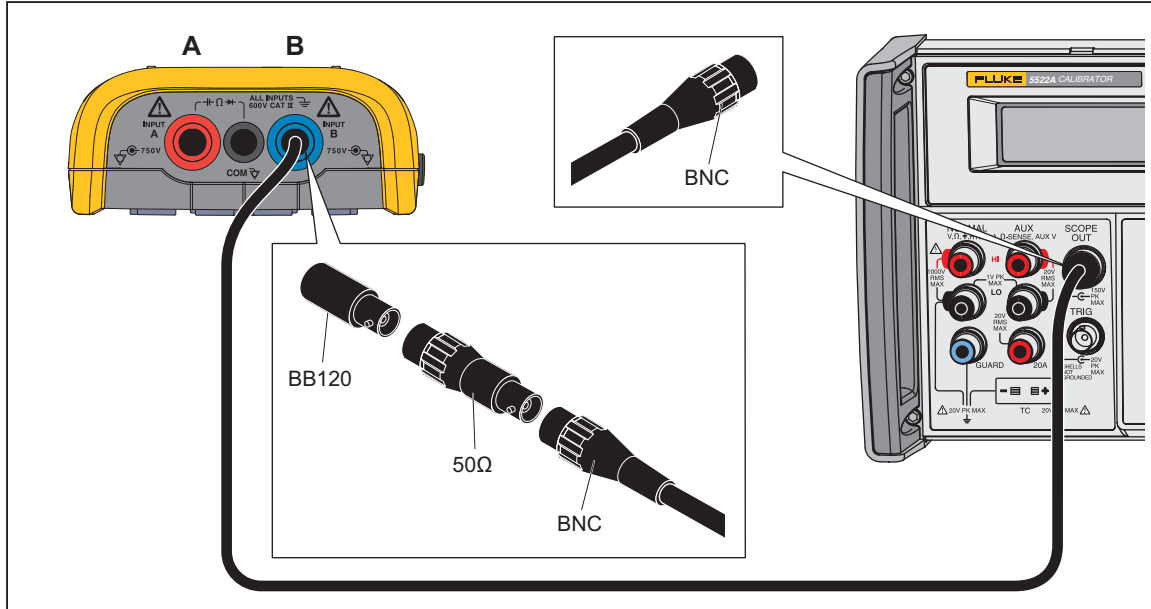

Figure 4. Test Tool Input B to Calibrator Scope Output 50 Ω

2. Set up the Test Tool:
 - a. Push **AUTO** to select auto ranging (AUTO shows at the top of the display).
 - b. Push **SCOPE METER**.
 - c. Push **F4** to open the INPUT B MEASUREMENTS menu.
 - d. Select **Hz**.
 - e. Push **ENTER** twice to close the menu.
 - f. Push **SCOPE METER**.
 - g. Push **F2** to open the SCOPE SETTINGS menu.
 - h. Make these selections:
 - Trigger Input: **B**
 - Update: **Free Run**
 - Type: **Normal**
 - Waveform: **Normal**
3. Set up the Calibrator:
 - a. Supply a leveled sine wave of 600 mV peak-to-peak (SCOPE output, MODE levsine).
 - b. Push **OPR**.
4. For each Output in Table 3:
 - a. On the Calibrator, supply the frequency listed. Start with 1 MHz.
 - b. Compare the Input B main reading on the Test Tool with the reading range listed in Table 3.

Input B Frequency Response Upper Transition Point Test

To test the Input B frequency response upper transition point:

1. Connect the Test Tool to the Calibrator. See Figure 4.
2. Set up the Test Tool:
 - a. Turn on Input B if necessary.
 - b. Push **AUTO**.

Note

*For this procedure, do not push **TIME**.*

- c. Use **mV** and **V** to change the sensitivity setting to manual sensitivity ranging and lock the Input B sensitivity on 200 mV/div.
- d. Push **SCOPE METER**.
- e. Push **F2** to open the SCOPE SETTINGS menu.
- f. Make these selections:
 - Trigger Input: **B**
 - Update: **Free Run**
 - Type: **Normal**
 - Waveform: **Normal**
3. Set up the Calibrator:
 - a. Supply a leveled sine wave of 50 kHz @ 1.2 V peak-to-peak, 50 kHz (SCOPE output, MODE levsine).
 - b. Push **OPR**.
4. Adjust the amplitude of the sine wave to 6 divisions.
5. On the Calibrator, supply 20 MHz (123B) or 40 MHz (124B/125B) without changing the amplitude.
6. Make sure the Input B trace is ≥ 4.2 divisions.

Note

The lower transition point is tested in Input A and Input B AC Input Coupling Test on page 25.

Input B Trigger Sensitivity Test

To test the Input B trigger sensitivity:

1. Connect the Test Tool to the Calibrator. See Figure 4.
2. Set up the Test Tool:
 - a. Turn on Input B if necessary.
 - b. Push **AUTO** to select auto ranging (AUTO shows at the top of the display).

Note

*For this procedure, do not push **TIME**.*

- c. Push **mV** or **V** to change the sensitivity setting to manual sensitivity ranging and lock the Input B sensitivity on 200 mV/div.
- d. Push **SCOPE METER**.
- e. Push **F2** to open the SCOPE SETTINGS menu.
- f. Make these selections:
 - Select Trigger Input: **B**
 - Update: **Free Run**
 - Type: **Normal**
 - Waveform: **Normal**.
3. Set up the Calibrator:
 - a. Supply a 5 MHz leveled sine wave of 100 mV peak-to-peak (SCOPE output, MODE levsine).
 - b. Push **OPR**.

4. Adjust the amplitude of the sine wave to 0.5 division on the display:
 - a. Verify that the signal is well triggered. If it is not, press **F2** to enable **▲▼** for Trigger Level adjustment.
 - b. Use **▲▼** to adjust the trigger level and verify that the signal is triggered.
The trigger icon (⌋) indicates the trigger level.
5. On the Calibrator, supply a 25 MHz (123B) or 40 MHz (124B/125B) leveled sine wave of 400 mV peak-to-peak.
6. Adjust the amplitude of the sine wave 1.5 divisions.
 - a. Verify that the signal is well triggered. If it is not, press **F2** to enable **▲▼** for Trigger Level adjustment.
 - b. Use **▲▼** to adjust the trigger level and verify that the signal is triggered.
7. On the Calibrator, supply a 40 MHz (123B) or 60 MHz (124B/125B) leveled sine wave of 1.8 V peak-to-peak.
8. Adjust the amplitude of the sine wave to exactly 4 divisions.
 - a. Verify that the signal is well triggered. If it is not, press **F2** to enable **▲▼** for Trigger Level adjustment.
 - b. Use **▲▼** to adjust the trigger level and verify that the signal is triggered.

Input A and Input B Trigger Level and Trigger Slope Test

In the trigger level and slope tests, some steps direct you to select positive or negative slope triggering.

To set up the Test Tool for positive or negative slope triggering:

1. Push **AUTO** and then **F2**.
2. Push **⏏** to select positive slope triggering (trigger icon ⌋) or negative slope triggering (trigger icon ⌋).
3. Push **▲▼** to set the trigger level to +2 divisions from the screen center.

Note

For positive slope triggering, the trigger level is at the top of the trigger icon (⌋). For negative slope triggering, the trigger level is the bottom of the trigger icon (⌋).

To test the trigger level and slope:

1. Connect the Test Tool to the Calibrator. See Figure 5.

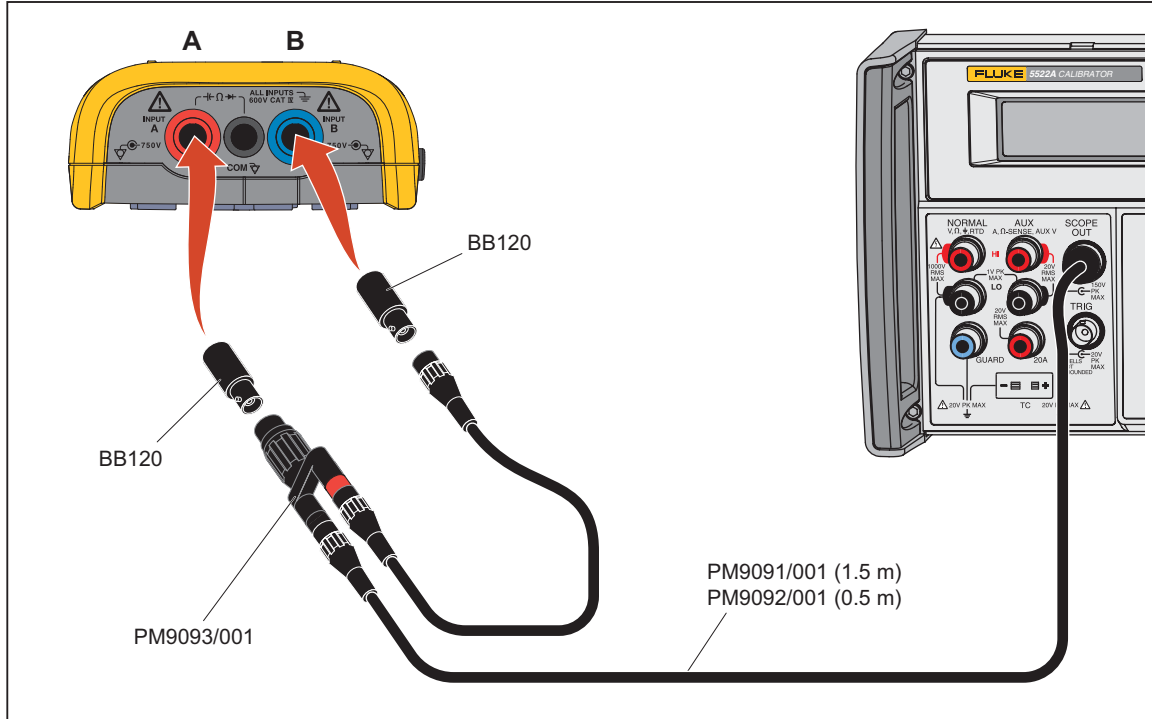













Figure 5. Test Tool Input A-B to Calibrator Scope Output

2. Set up the Test Tool:
 - a. Turn on Input B if necessary.
 - b. Push **mV** or **V** to change the sensitivity setting to manual sensitivity ranging and lock the Input A and Input B sensitivity on 1 V/div.
 - c. Move the Input A and Input B ground level to the center grid line.
3. Set up Vac + dc on the Test Tool:
 - a. Push **SCOPE METER**.
 - b. Push **F1**.
 - c. Select **Vac + dc**.
 - d. Push **ENTER**.
 - e. Push **F1** to switch between moving A or B. If A or B is not at the center, use **▲▼** to move them there.
4. Use **TIME** to change the time base setting to manual time base ranging and lock the time base on 10 ms/div.
5. Setup the Test Tool to test Input A:
 - a. Push **SCOPE METER** to open the SCOPE SETTINGS menu.
 - b. Select Trigger Input: **A**, Update: **Single**, Type: **Normal**, and Waveform: **Normal**.



6. Push **F2** to setup the Test Tool to test the positive slope. Use **▲▼** to set the trigger level to +2 divisions. For **positive slope** triggering, the trigger level is the **top** of the trigger icon.
7. Setup the Calibrator:
 - a. Supply 1.1 V DC.
 - b. Push **OPR**.
8. Verify that traces do not show on the display of the Test Tool and that Waiting shows on the status line at the top of the display.
If traces show on the display and Hold shows on the status line at the top of the display, push **HOLD RUN** to reset the Test Tool.
9. Use the EDIT FIELD function on the Calibrator to slowly increase the voltage in 0.1 V steps until the Test Tool triggers and the traces show on the display.
10. Verify that the voltage on the Calibrator is between +1.5 V and +2.5 V when the Test Tool triggers.
11. To repeat the test, start at step 8.
12. Set the Calibrator to Standby.
13. Push **HOLD RUN** to clear the display.
14. Setup the Test Tool to test the negative slope. Use **▲▼** to set the trigger level to +1 divisions. For **negative slope** triggering, the trigger level is the **bottom** of the trigger icon.
15. Setup the Calibrator:
 - a. Supply +2 V DC.
 - b. Push **OPR**.

16. Verify that traces do not show on the display of the Test Tool and that Waiting shows on the status line at the top of the display.
If traces show on the display and Hold shows on the status line at the top of the display, push  to reset the Test Tool.
17. Use the EDIT FIELD function on the Calibrator to slowly decrease the voltage in 0.1 V steps until the Test Tool triggers and the traces show on the display.
18. Verify that the voltage on the Calibrator is between +0.5 V and +1.5 V when the Test Tool triggers.
19. To repeat the test, start at step 15.
20. Set the Calibrator to Standby.
21. Push  to clear the display.
22. Set up the Test Tool to test Input B:
 - a. Push .
 - b. Push  to open the SCOPE SETTINGS menu.
 - c. Make these selections:
 - Trigger Input: **B**
 - Update: **Single**
 - Type: **Normal**
 - Waveform: **Normal**
23. Push  to setup the Test Tool to test the positive slope. Use  to set the trigger level to +2 divisions. For **positive slope** triggering, the trigger level is the **top** of the trigger icon.
24. Set up the Calibrator:
 - a. In the Scope Volt mode, supply 1.1 V DC.
 - b. Push .
25. Verify that traces do not show on the display of the Test Tool and that Waiting shows on the status line at the top of the display.
If traces show on the display and Hold shows on the status line at the top of the display, push  to reset the Test Tool.
26. Use the EDIT FIELD function on the Calibrator to slowly increase the voltage in 0.1 V steps until the Test Tool triggers and the traces show on the display.
27. Verify that the voltage on the Calibrator is between +1.5 V and +2.5 V when the Test Tool triggers.
28. To repeat the test, start at step 24.
29. Set the Calibrator to Standby.
30. Push  to clear the display.
31. Set up the Test Tool to test the negative slope. Use  to set the trigger level to +1 divisions. For **negative slope** triggering, the trigger level is the **bottom** of the trigger icon.
32. Set up the Calibrator:
 - a. Supply +2 V DC.
 - b. Push .
33. Verify traces do not show on the display of the Test Tool and that Waiting shows on the status line at the top of the display.
If traces show on the display and Hold shows on the status line at the top of the display, push  to reset the Test Tool.
34. Use the EDIT FIELD function on the Calibrator to slowly decrease the voltage in 0.1 V steps until the Test Tool triggers and the traces show on the display.
35. Verify that the voltage on the Calibrator is between +0.5 V and +1.5 V when the Test Tool triggers.
36. To repeat the test, start at step 32.

Input A and Input B DC Voltage Accuracy Test

⚠⚠ Warning

To prevent possible electrical shock, fire, or personal injury, make sure that the calibrator is in standby mode before making any connection between the calibrator and the test tool. Dangerous voltages will be present on the calibration source and connecting cables during the following steps.

To test the Input A and B voltage accuracy:

1. Connect the test tool to the Calibrator. See Figure 6.

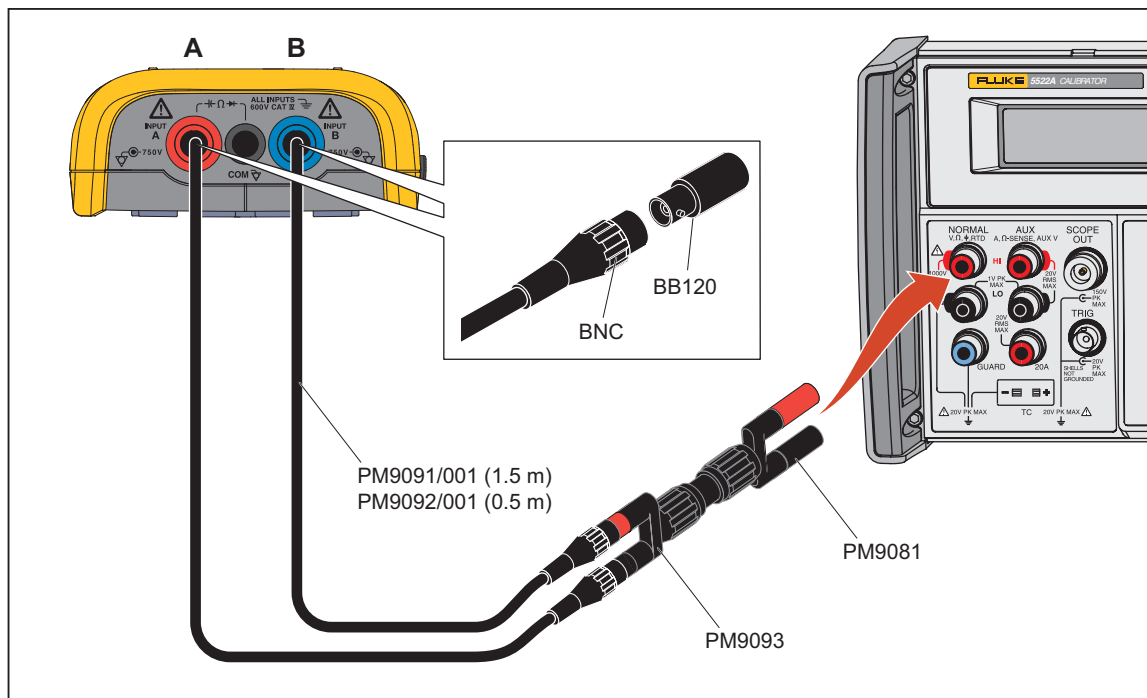

Figure 6. Test Tool Input A-B to Calibrator Normal Output

2. Setup V dc on the Test Tool:
 - a. Push **AUTO**.
 - b. Push **SCOPE METER**.
 - c. Push **F1** to open the MEASURE A menu.
 - d. Select **V dc**.
 - e. Push **ENTER**.
 - f. Push **SCOPE METER**.
 - g. Push **F4** to open the MEASURE B menu.
 - h. Select **V dc**.
 - i. Push **ENTER**.
3. Use **TIME RS** to change the time base to select manual time base ranging and lock the time base on 10 ms/div.
4. Move the Input A and Input B ground level to the center grid line.
5. Push **F1** to toggle between **Move A** and **Move B**. If A or B is not at the center, use **↔** to move them to the center.
6. Set up the input settings on the Test Tool:
 - a. Push **SCOPE METER**.
 - b. Push **F3** to open the INPUT SETTINGS A menu.
 - c. Make these selections:
 - Select Coupling: **DC**
 - Readings: **Smooth**
 - Noise filter: **ON**.

- d. Push **SCOPE METER**.
 - e. Push **F3** to open the INPUT SETTINGS A menu.
 - f. Push **F2** to open the INPUT SETTINGS B menu.
 - g. Make these selections:
 - Select Coupling: **DC**
 - Readings: **Smooth**
 - Noise filter: **ON**
7. For each sensitivity value listed in Table 4:
- a. On the Test Tool, push **mV** or **V** to set the Input A and Input B sensitivity.
The range is listed in the second column.
 - b. Set up the Calibrator:
 - i. Source the DC voltage listed in Table 4.
 - ii. Push **OPR**.
 - c. Compare the main reading to the limits in Table 4.
8. Set the Calibrator to 0 V (zero).

Table 4. Volts DC Measurement Verification Points

Sensitivity (Oscilloscope)	Range ^[1] (Meter)	Calibrator Output V DC	Input A-B DC Limit
5 mV/div	500 mV	15 mV	014.4 to 015.6 ^[2]
10 mV/div	500 mV	30 mV	029.3 to 030.7 ^[2]
20 mV/div	500 mV	60 mV	059.2 to 060.8
50 mV/div	500 mV	150 mV	148.7 to 151.3
100 mV/div	500 mV	300 mV	298.0 to 302.0
200 mV/div	500 mV	500 mV	497.0 to 503.0
		-500 mV	-497.0 to -503.0
		0 mV	-000.5 to + 000.5
500 mV/div	5 V	1.5 V	1.487 to 1.513
1 V/div	5 V	3 V	2.980 to 3.020
2 V/div	5 V	5 V	4.970 to 5.030
		-5 V	-4.970 to -5.030
		0 V	-0.005 to +0.005
5 V/div	50 V	15 V	14.87 to 15.13
10 V/div	50 V	30 V	29.80 to 30.20
20 V/div	50 V	50 V	49.70 to 50.30
		-50 V	-49.70 to -50.30
		0 V	-00.05 to +00.05
50 V/div	500 V	150 V	148.7 to 151.3
100 V/div	500 V	300 V	298.0 to 302.0

[1] The 500 V and 750 V range is tested in *Input A and B High Voltage AC/DC Accuracy Test* on page 28.
 [2] OL (overload) shows on the display occasionally when there is calibrator noise.

Input A and Input B AC Voltage Accuracy Test

⚠⚠ Warning

To prevent possible electrical shock, fire, or personal injury, make sure that the calibrator is in standby mode before making any connection between the calibrator and the test tool. Dangerous voltages will be present on the calibration source and connecting cables during the following steps.

To test the Input A and Input B ac voltage accuracy:

1. Connect the test tool to the Calibrator. See Figure 6.
2. Setup V ac on the Test Tool:
 - a. Push **AUTO** to select auto ranging (AUTO shows at the top of the display).

Note

For this procedure, do not press **TIME**.

- b. Push **SCOPE METER**.
 - c. Push **F1** to open the MEASURE A menu.
 - d. Select **V ac**.
 - e. Push **ENTER**.
 - f. Push **SCOPE METER**.
 - g. Push **F4** to open the MEASURE B menu.
 - h. Select **V ac**.
 - i. Push **ENTER**.
3. If A or B is not at the center, push **←** or **→** to move them to the center and push **F1** to toggle between A or B.
4. For each sensitivity value listed in Table 5:
 - a. On the Test Tool, push **mV** or **V** to set the Input A and Input B sensitivity. The range is listed in the second column.
 - b. Set up the Calibrator:
 - i. Supply the AC voltage (NORMAL output, WAVE sine) listed in Table 5.
 - ii. Push **OPR**.
 - c. Compare the Test Tool reading to the limit in Table 5.

Table 5. Volts AC Measurement Verification Points

Sensitivity (Oscilloscope)	Range ⁽¹⁾ (Meter)	Calibrator Output V rms	Calibrator Frequency	Limit A-B
200 mV/div	500 mV	500 mV	60 Hz	494.0 to 506.0
		500 mV	20 kHz	486.0 to 514.0
2 V/div	5 V	5 V	20 kHz	4.860 to 5.140
		5 V	60 Hz	4.940 to 5.060
20V/div	50 V	50 V	60 Hz	49.40 to 50.60
		50 V	20 kHz	48.60 to 51.40

Input A and Input B AC Input Coupling Test

To test the Input A and B ac input coupling:

1. Connect the Test Tool to the Calibrator. See Figure 6.
2. Set up the Test Tool:
 - a. Push **SCOPE METER**.
 - b. Push **F3** to open the INPUT SETTINGS A menu and make these selections:
 - Select Coupling: **AC**
 - Readings: **Smooth**
 - Noise filter: **OFF**
 - c. Push **SCOPE METER**.
 - d. Push **F2** to open the INPUT SETTINGS B menu and make these selections:
 - Coupling: **AC**
 - Readings: **Smooth**
 - Noise filter: **OFF**
3. For each sensitivity value listed in Table 6:
 - a. On the Test Tool, push **mV** or **V** to set the Input A and Input B sensitivity.
 - b. Set up the Calibrator:
 - i. Supply the voltage and frequency listed in Table 6.
 - ii. Push **OPR**.
 - c. Compare the Test Tool reading to the limit in Table 6.
 - d. Set the Calibrator to 0 V (zero).

Table 6. Input A and Input B AC Input Coupling Verification Points

Calibrator Output V rms	Calibrator Frequency	Limit A-B
500 mV	10 Hz	>344.0
500 mV	33 Hz	>469.0
500 mV	60 Hz	>486.5

Input A and Input B Volts Peak Measurements Test

⚠⚠ Warning

To prevent possible electrical shock, fire, or personal injury, make sure that the calibrator is in standby mode before making any connection between the calibrator and the Test Tool. Dangerous voltages will be present on the calibration source and connecting cables during the following steps.

To test the Input A and Input B volts peak measurements:

1. Connect the Test Tool to the Calibrator. See Figure 6.
2. Setup Peak for Input A on the Test Tool:
 - a. Push **AUTO** to select auto ranging (AUTO shows at the top of the display).
 - b. Push **SCOPE METER**.
 - c. Push **F1** to open the INPUT A MEASUREMENTS menu.
 - d. Select **Peak** and push **ENTER** to open the Peak submenu.
 - e. Select **Peak Max-Min**.

- f. Push **ENTER** to close the submenu.

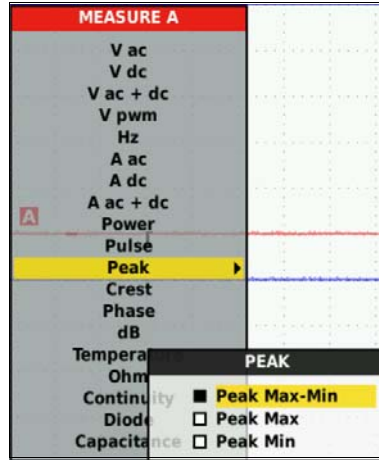

3. Set up Peak for Input B on the Test Tool:
 - a. Push **SCOPE METER**.
 - b. Push **F4** to open the INPUT B MEASUREMENTS menu.
 - c. Select **Peak** and push **ENTER** to open the Peak submenu.
 - d. Select **Peak Max-Min**.
 - e. Push **ENTER** to close the submenu.
4. Push **mV** or **V** to set 1 V/div for Input A and Input B.
5. Setup the Calibrator:
 - a. Supply a sine wave.
 - b. Supply the voltage and frequency in Table 7 (NORMAL output, WAVE sine).
 - c. Push **OPR**.
6. Compare the Input A and Input B main reading to the limit in Table 7.

Table 7. Volts Peak Verification Points

Calibrator Output V rms (Sine)	Calibrator Frequency	Limit A-B
1.768 (5 V peak)	1 kHz	4.50 to 5.50

Input A and B Phase Measurements Test

To test the Input A and B phase measurements:

1. Connect the Test Tool to the Calibrator. See Figure 6.
2. Set up the Test Tool:
 - a. Push **SCOPE METER**.
 - b. Push **F1** to open the INPUT A MEASUREMENTS menu.
 - c. Select **Phase**.
 - d. Push **ENTER**.
 - e. Push **SCOPE METER**.
 - f. Push **F4** to open the INPUT B MEASUREMENTS menu.
 - g. Select **Phase**.
 - h. Push **ENTER**.
3. Push **mV** or **V** to set 1 V/div for Input A and Input B.
4. Set up the Calibrator:
 - a. Supply a sine wave.
 - b. Supply the voltage and frequency in Table 8 (NORMAL output, WAVE sine).
 - c. Push **OPR**.
5. Compare the Input A and Input B main reading to the limit in Table 8.

Table 8. Volts Peak Verification Points

Calibrator Output V rms (Sine)	Calibrator Frequency	Limit A-B
1.5 V	1 kHz	-2 degrees to +2 degrees

Harmonics Test (125B)

To test the harmonics:

1. Connect the Test Tool to the Calibrator. See Figure 6.
2. Setup the Test Tool:
 - a. Push **MENU** to open MENU.
 - b. Push **▶▼** to highlight POWER HARMONICS.
 - c. Push **F3** to open the SETTINGS menu.
 - d. Select **Probe B: Select**.
 - e. Push **ENTER**.
 - f. Select **SENSITIVITY: 10 mV/A**.
3. Set up the CalibratorCalibrator:
 - a. Supply a square wave.
 - b. Supply 2.5 Vpp, 60 Hz (NORMAL output, WAVE square).
 - c. Push **OPR**.

Figure 7 shows an example of the Bargraph Harmonics.

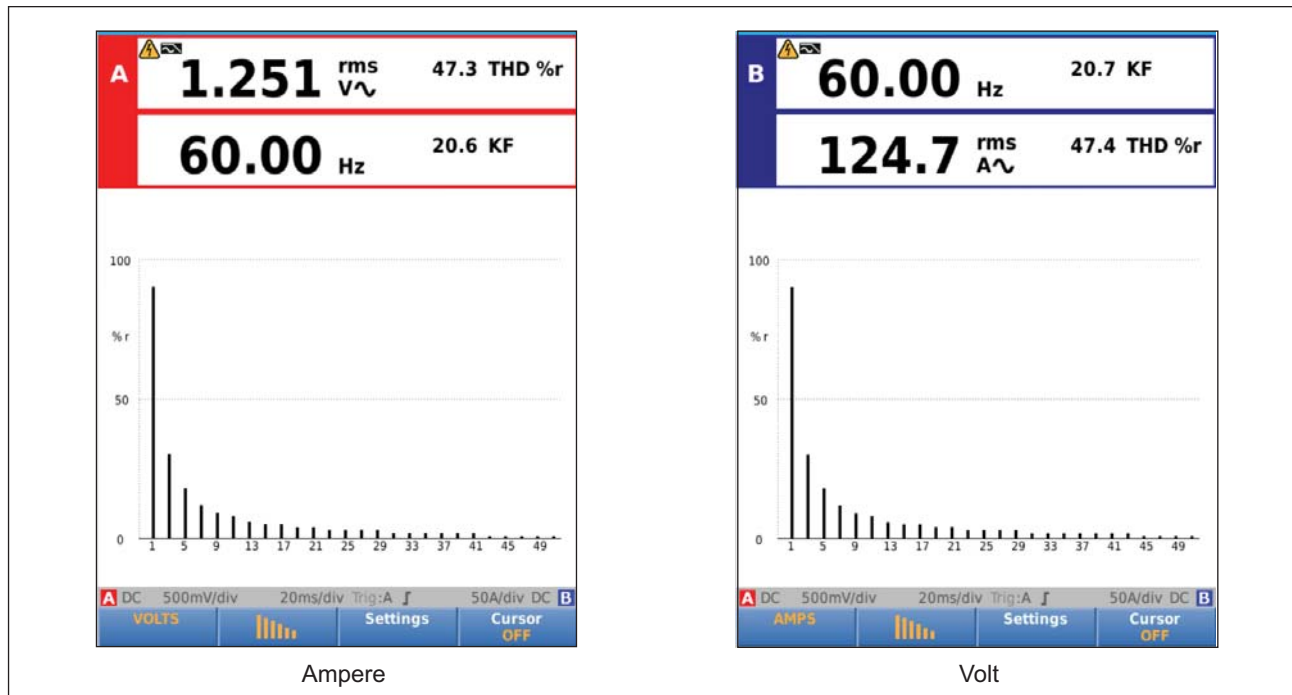

Figure 7. Bargraph Harmonics

Input A and B High Voltage AC/DC Accuracy Test

Warning

To prevent possible electrical shock, fire, or personal injury, make sure that the calibrator is in Standby mode before making any connection between the calibrator and the Test Tool. Dangerous voltages will be present on the calibration source and connecting cables during the following steps.

To test the Input A and B high voltage ac/dc accuracy:

1. Connect the Test Tool to the Calibrator. See Figure 8.

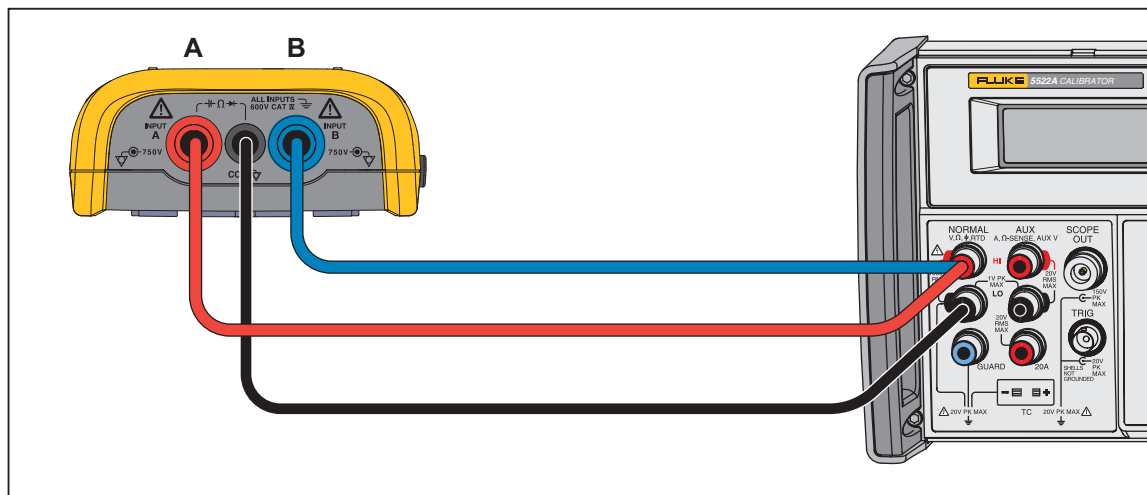

Figure 8. Test Tool Input A-B to Calibrator Normal Output for >300 V

2. Setup V ac and V dc for Input A on the Test Tool:
 - a. Push **AUTO** to select auto ranging (AUTO shows at the top of the display).

Note

*For this procedure, do not push **TIME**.*

- b. Push **SCOPE METER**.
 - c. Push **F1** to open the INPUT A MEASUREMENTS menu.
 - d. Select **V ac**.
 - e. Push **SCOPE METER**.
 - f. Push **F1** to open the INPUT A MEASUREMENTS menu.
 - g. Select **V dc**.
V dc becomes the main reading, V ac is the secondary reading.
3. Setup V ac and V dc for Input B on the Test Tool:
 - h. Push **SCOPE METER**.
 - i. Push **F4** to open the INPUT B MEASUREMENTS menu.
 - j. Select **V ac**.
 - k. Push **SCOPE METER**.
 - l. Push **F4** to open the INPUT B MEASUREMENTS menu.
 - m. Select **V dc**.
4. Move the Input A and Input B ground level to the center grid line.
5. Push **F1** to switch between moving A or B.
6. If A or B is not at the center, push **↔** to move them to the center.
7. For each sensitivity value listed in Table 9:
 - a. On the Test Tool, push **mV** or **V** to set the Input A and Input B sensitivity.
The range is listed in the second column of Table 9.
 - b. Set up the Calibrator:
 - i. Supply the AC voltage (NORMAL output, WAVE sine) listed in Table 9.
 - ii. Push **OPR**.
 - c. Compare the main reading (V-dc) and secondary reading (V-ac) to the readings in Table 9.

Table 9. V DC and V AC High Voltage Verification Points

Sensitivity (Oscilloscope)	Range (Meter)	Calibrator Output V rms	Calibrator Frequency	Main (DC) Reading A-B	Secondary (AC) Reading A-B
200 V/div	500 V	0 V	DC	-000.5 to +000.5	
		+500 V	DC	+497.0 to +503.0	
		-500 V	DC	-497.0 to -503.0	
		500 V	60 Hz		494.0 to 506.0
		500 V	10 kHz		486.0 to 514.0

Resistance Measurements Test

To test the resistance measurements:

1. Connect the Test Tool to the Calibrator. See Figure 9.

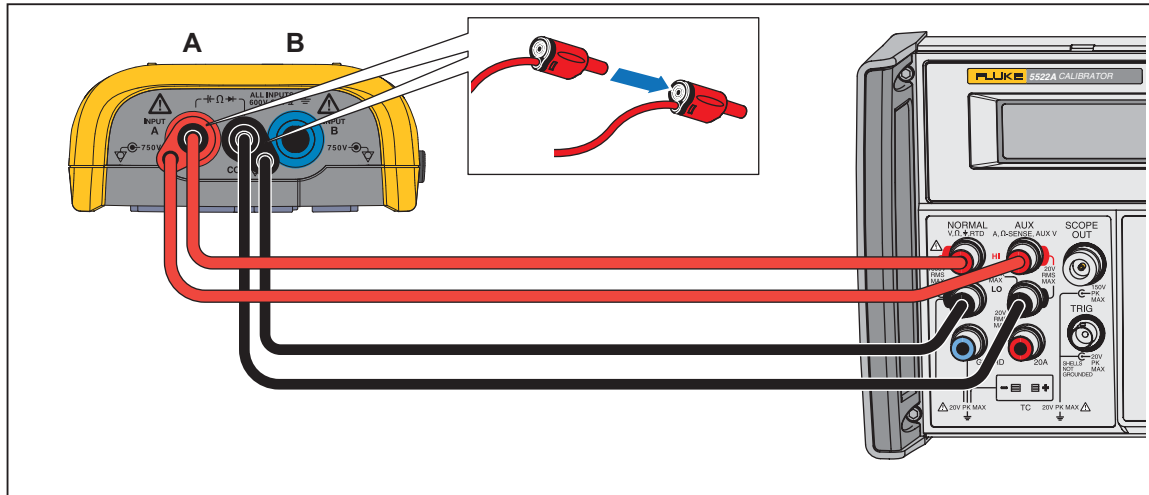

Figure 9. Test Tool Input A to Calibrator Normal Output 4-Wire

2. Setup the Test Tool:
 - a. Push **AUTO** to select auto ranging (AUTO shows at the top of the display).
 - b. Push **SCOPE METER**.
 - c. Push **F1** to open the INPUT A MEASUREMENTS menu.
 - d. Select **OHM**.
3. For each output listed in Table 10, set up the Calibrator:
 - a. Supply the Output value.
 - b. Push **OPR**.
 - c. Use the “COMP 2 wire” mode.
 - d. Compare the main reading to the limit in Table 10.

Table 10. Resistance Measurement Verification Points

Calibrator Output	Limit
0 Ω	000.0 to 000.5
400 Ω	397.1 to 402.9
4 k Ω	3.971 to 4.029
40 k Ω	39.71 to 40.29
400 k Ω	397.1 to 402.9
4 M Ω	3.971 to 4.029
30 M Ω	29.77 to 30.23

Continuity Function Test

To test the continuity function:

1. Connect the Test Tool to the Calibrator. See Figure 9.
2. Set up the Test Tool:
 - a. Push **AUTO** to select auto ranging (AUTO shows at the top of the display).
 - b. Push **SCOPE METER**.
 - c. Push **F1** to open the INPUT A MEASUREMENTS menu.
 - d. Select **CONT**.

3. Set up the Calibrator:
 - a. Supply 25 Ω
 - b. Use the “COMP 2 wire” mode.
 - c. Push **OPR**.
4. Make sure the beeper sounds continuously.
5. On the Calibrator, supply 35 Ω .
6. Make sure the beeper does not sound.

Diode Function Test

To test the diode function:

1. Connect the Test Tool to the Calibrator. See Figure 9.
2. Setup the Test Tool:
 - a. Push **SCOPE METER**.
 - b. Push **F1** to open the INPUT A MEASUREMENTS menu.
 - c. Select **DIODE**.
3. Set up the Calibrator:
 - a. Supply 1 k Ω .
 - b. Use the Calibrator “COMP 2 wire” mode.
 - c. Push **OPR**.
4. Verify the main reading is between 0.425 V and 0.575 V.
5. On the Calibrator, supply **1 V DC**.
6. Verify the main reading is between 0.975 V and 1.025 V.

Capacitance Measurements Test

To test the capacitance measurement function:

1. Connect the Test Tool to the Calibrator. See Figure 9.
2. Set up the Test Tool:
 - a. Push **SCOPE METER**.
 - b. Push **F1** to open the INPUT A MEASUREMENTS menu.
 - c. Select **CAP**.
3. Push **mV** and **V** to select manual ranging.
4. For each Range and Output value in Table 11:
 - a. Set up the Calibrator:
 - i. Supply the Range and Output.
 - ii. Use the Calibrator “COMP OFF” mode.
 - iii. Push **OPR**.
 - b. Compare the Input A main reading to the limit listed in Table 11.

Table 11. Input A and Input B AC Input Coupling Verification Points

Calibrator Output	Range	Limit
0.56 nF	50 nF	0.45 to 0.67
0.5 nF	50 nF	48.90 to 51.10
5 nF	500 nF	3.9 to 6.1
500 nF	500 nF	489.0 to 511.0
0.05 μ F	5 μ F	0.039 to 0.061
5 μ F	5 μ F	4.890 to 5.110
0.5 μ F	50 μ F	0.39 to 0.61
50 μ F	50 μ F	48.90 to 51.10
5 μ F	500 μ F	3.9 to 6.1
500 μ F	500 μ F	489.0 to 511.0

LED, Beeper, LCD, and Front Panel Functional Checks

To go to the test mode:

1. Push **MENU**.
2. Push **F1** and **F3** at the same time.

To test the LED:

- LED 1 is a Red LED in the power switch
 - LED 2 is a Green LED in the power switch;
 - LED 3 is a blue LED in the WiFi button
1. Push **F1** **F2** **F3** to turn on and turn off the three LED lights.

To test the Beeper:

1. Push **F4** to go to the next page of the menu.
2. Select **Beeper**. **F1** toggles the Beeper on and off.
3. Verify the Beeper sounds.

To test the LCD:

1. Push **F2** for the **LCD** test.
The entire screen shows as red.
2. Push **F2** several times.
The screen changes to dark, white, green, blue, and exits the test.

To test the Front Panel:

1. Push **F3** for the **FP** test.
The screen shows a button menu.
2. Push the buttons as directed on the display.
When you pushed all of the buttons, the front panel test exits automatically.



To exit the functional tests:

1. Push **D** to show the next page of menu.
2. Push **F4** to **Exit**.

WiFi Functional Check (Version Dependent)

The Test Tool may include a WiFi radio if certified for your region. The WiFi interface plugs into a USB connector that is located under the battery door. If a WiFi adapter is present, a simple communication test is adequate.

To test:

1. Push .
The UI shows **WiFi Off**.
2. Push **F1** to detect the WiFi adapter.
If WiFi is detected, the UI shows **WiFi On**, the  will light, and  shows on the display.

Calibration Adjustment

This section provides the complete Calibration Adjustment procedure for the Test Tool. Each Test Tool allows closed-case calibration using known reference sources. It measures the reference signals, calculates the correction factors, and stores the correction factors in RAM. After the calibration is complete, the correction factors can be stored in FlashROM.

Calibrate the Test Tool after it is repaired or if it fails the performance test. The Test Tool has a normal calibration cycle of one year. All Test Tool models use the same Calibration Adjustment procedure.

For all calibration steps:

1. Let the Calibrator warm up. See the Calibrator Operators Manual.
2. For each calibration point, wait for the Calibrator to become stable.
3. Let the Test Tool warm up. See *Warm Up and Pre-Calibration* on page 34.
4. Make sure the Test Tool battery is charged sufficiently.
5. See Table 2 for a list of required equipment. If a Calibrator is not available, you can substitute another calibrator as long as it meets the minimum test requirements.

Calibration Number and Date

When valid calibration data is stored in FlashROM after the calibration adjustment procedure is done, the calibration date is set to the actual Test Tool date and the calibration number increments by one.

To display the calibration number and date:

1. Push **MENU** to open the USER OPTIONS menu.
2. Push **ENTER**.
3. Highlight **Information**.
4. Push **ENTER** to open the INFORMATION screen.
5. Push **F4** to return to normal mode.

Start the Calibration Adjustment

To start calibration adjustments:

1. Power the Test Tool with the BC430 power adapter.
2. Check the Test Tool date and adjust the date if necessary:
 - a. Push **MENU** to open the USER OPTIONS menu.
 - b. Push **↔** to highlight **Date Format**.
 - c. Push **ENTER** to select format and adjust the date.

The Calibration Adjustment Procedure uses built-in calibration setups that are accessed in the Maintenance mode.

To go to the Maintenance mode:

1. Push and hold **Ⓜ**.
2. Push and release **F4**.
3. Release **Ⓜ**.

The display shows the Calibration Adjustment Screen and the first calibration step, Warming Up (CL 0200), and the calibration status **:IDLE (valid)** or **:IDLE (invalid)**.

When the Test Tool is in the Maintenance Mode, only the F1 to F4 soft keys, the ON/OFF key, and the backlight key operate, unless otherwise stated. The Calibration Adjustment Screen shows the actual calibration step (name and number) and its status in this format:

Cal Name (CL nnnn) :Status Calibration step nnnn

See Table 12 for an explanation of the screen messages and softkey functions.

Table 12. Screen Messages and Softkey Functions

Status Message or Softkey	Explanation
IDLE (valid)	After (re)entering this step, the calibration process is not started. The calibration data of this step are valid. This means that the last time this step was done, the calibration process was successful. It does not necessarily mean that the unit meets the specifications related to this step.
IDLE (invalid)	After (re)entering this step, the calibration process is not started. The calibration data are invalid. This means that the unit will not meet the specifications if the calibration data are saved.
BUSY aaa% bbb%	Calibration adjustment step in progress; progress % for Input A and Input B.
READY	Calibration adjustment step finished.
Error :xxxx	Calibration adjustment failed, due to wrong input signal(s) or because the Test Tool is defective. The error codes xxxx are shown for production purposes only.
<input type="button" value="F1"/> PREV	Select the previous step.
<input type="button" value="F2"/> NEXT	Select the next step.
<input type="button" value="F3"/> CAL	Start the calibration adjustment of the actual step.
<input type="button" value="F4"/> EXIT	Leave the Maintenance mode.

After you complete a calibration step, readings and traces show with the new calibration data.

Warm Up and Pre-Calibration

When the Test Tool enters the Warm Up and Pre-Calibration state, the display shows:

WarmingUp (CL 0200):IDLE (valid) or (invalid).

Note

You must always start the Warming-Up and Pre-Calibration at Warming-Up (CL0200) . Starting at any other step will make the calibration invalid.

To start the warm up:

1. Remove all input connections from the Test Tool.
2. Push to start the Warming-Up & Pre-Calibration procedure.

The display shows the calibration step in progress, and its status. The first step is:

WarmingUp (CL0200) :BUSY 00:29:59

The warming-up period is counted down from 00:29:59 to 00:00:00. The other pre-calibration steps are performed automatically. The procedure takes about 60 minutes.

3. Wait until the display shows **End Precal :READY** and continue to *Final Calibration*.

Final Calibration

It is important that you always start the Final Calibration at the first step. Starting at another step will make the calibration invalid. If you proceed to step N (for example, step CL 0615), return to a previous step (for example, step CL 0613), and then calibrate this step, the complete final calibration becomes invalid. You must do the final calibration from the beginning (step CL 0600) again.

Push to repeat a step that shows the status **:READY**.

Delta T Gain, LF- HF Gain Input, Filter, A & B

To do the HF Gain Input A & B calibration:

1. Push to select the first Calibration Step, **Delay (CL 0280):**, in Table 13.
2. Connect the Test Tool to the Calibrator. See Figure 10. Make sure you use a single 50 Ω terminator at the end of the connection.

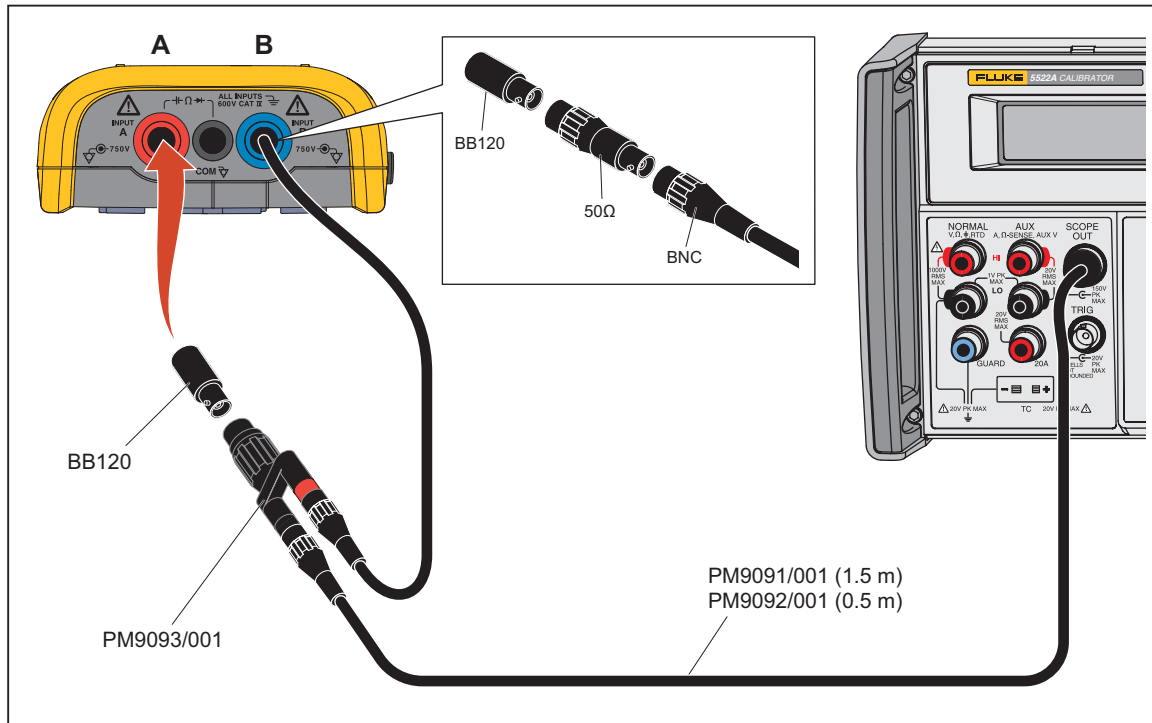

Figure 10. HF Gain Calibration Input Connections

3. Connect the Calibrator Scope Out to CH A & CH B with a 50 Ω terminator. Only one 50 Ω terminator should be connected at the connection farthest from the calibrator. Make sure the cable between CH A and CH B is as short as possible.
4. Set up the Calibrator:
 - a. Supply a 1 kHz fast rising edge square wave (Output SCOPE, MODE edge).
 - b. Set the Calibration Step in Table 13.
 - c. Push **OPR**.
5. On the Test Tool:
 - a. Push **F3** to start the calibration.
 - b. Wait until **READY** shows as the calibration status on the display.
 - c. Push **F2** to select the next calibration step.
6. Repeat steps 4 through 5 for each Calibration Step in Table 13.

Table 13. HF Gain Calibration Points Fast

Calibration Step	Calibrator Setting ^[1] (1 kHz, Scope Mode EDGE)
Delay (CL 0280)	1.0 V
LF Gain (CL 0300)	0.5 V
LF Gain (CL 0310)	0.1 V
LF Gain (CL 0320)	2.5 V

[1] After you start the first step in this table cell, other steps are done automatically.

7. Connect the calibrator Scope Output to both CH A and CH B without the 50 Ω terminator.
8. Set up the Calibrator:
 - a. Supply a 1 kHz square wave (Output SCOPE, Mode VOLT).
 - b. Set the Calibration step in Table 14.
 - c. Push **OPR**.
9. On the Test Tool:
 - a. Push **F2** to select the first Calibration Step in Table 14.
 - b. Push **F3** to start the calibration.
 - c. Wait until **READY** shows as the calibration status on the display.
 - d. Push **F2** to select the next calibration step.
10. Repeat steps 8 through 9 for each Calibration Step in Table 14.
11. Put the Calibrator in Standby.
12. Continue to the next section.

Table 14. HF Gain Calibration Points Slow

Calibration Step	Calibrator Setting ^[1] (1 kHz, Scope Mode EDGE)
LF-Gain- (CL 0330)	25 V
LF-Gain (CL 0335)	50 V

[1] After starting the first step in this table cell, other steps are done automatically.

Position, Input A and B

To do the position calibration:

1. Push **F2** to select calibration step, **Position (CL 0400):IDLE**.
2. Disconnect all connections to the Test Tool inputs.
3. Push **F3** to start the calibration.
The Position (CL0400) to (CL0414) calibrates.
4. Wait until **Position (CL 0414):READY** shows on the display.
5. Continue to the next section.

Pulse Adjust Input B

To do the Pulse Adjust Input A calibration:

1. Push **F2** to select calibration step **Volt Zero (CL 0420):IDLE**.
2. Connect 50 Ω Terminators to the A and B inputs (BB120 and TRM50).
3. Push **F3** to start the calibration.
4. Wait until **Volt Zero (CL 0434):READY** shows on the display.
5. Continue to the next section.

Gain DMM (Gain Volt)

⚠⚠ Warning

To prevent possible electrical shock, fire, or personal injury, make sure that the calibrator is in standby mode before making any connection between the calibrator and the Test Tool. Dangerous voltages will be present on the calibration source and connecting cables during the following steps.

To do the Gain DMM calibration:

1. On the Test Tool, push **F2** to select the first Calibration Step in Table 15.
2. Connect the Test Tool to the Calibrator as shown in Figure 11.

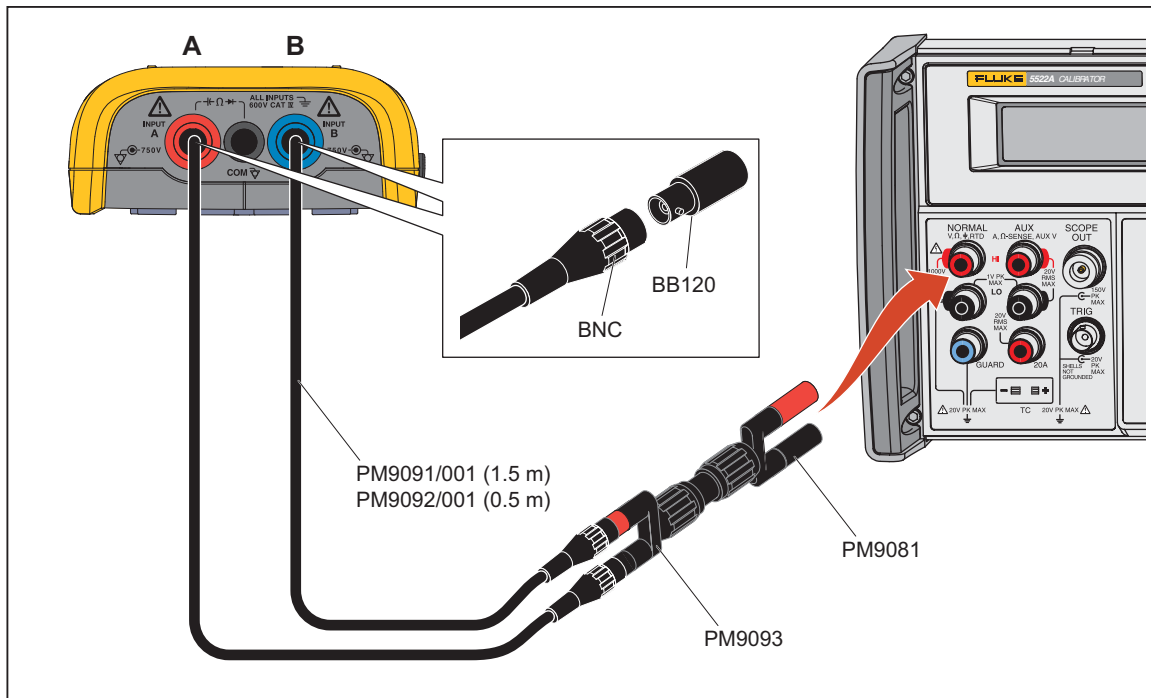

Figure 11. Volt Gain Calibration Input Connections <300 V

3. Set up the Calibrator:
 - a. Supply an AC voltage at 50 Hz to the first calibration point in Table 15.
 - b. Push **OPR**.
4. On the Test Tool:
 - a. Push **F3** to start the calibration.
 - b. Wait until **:READY** shows as the calibration status on the display.
 - c. Push **F2** to select the next calibration step.
5. Repeat steps 3 through 4 for each Calibration Step in Table 15.
6. Put the Calibrator in Standby.

Table 15. Volt Gain Calibration Points <300

Calibration Step	Input Value
Gain DMM (CL0440)	12.5 mV
Gain DMM (CL0441)	25 mV
Gain DMM (CL0442)	50 mV
Gain DMM (CL0443)	125 mV
Gain DMM (CL0444)	250 mV
Gain DMM (CL0445)	500 mV
Gain DMM (CL0446)	1.25 V
Gain DMM (CL0447)	2.5 mV
Gain DMM (CL0448)	5 V
Gain DMM (CL0449)	12.5 V
Gain DMM (CL0450)	25 V
Gain DMM (CL0451)	50 V (set Calibrator to OPR)
Gain DMM (CL0452)	125 V
Gain DMM (CL0453)	250 V
Gain DMM (CL0454)	500 V
iFlex (CL0480)	13 mV at 150 Hz

7. Push **F2** to select calibration step **Zero Ohm (CL0500) :IDLE**.
8. Short CH A to COM.
9. Push **F3** to start the calibration.
10. Wait until **Zero OHM (CL 0506):READY** shows on the display.
11. Connect the Test Tool to the Calibrator as shown in Figure 12.

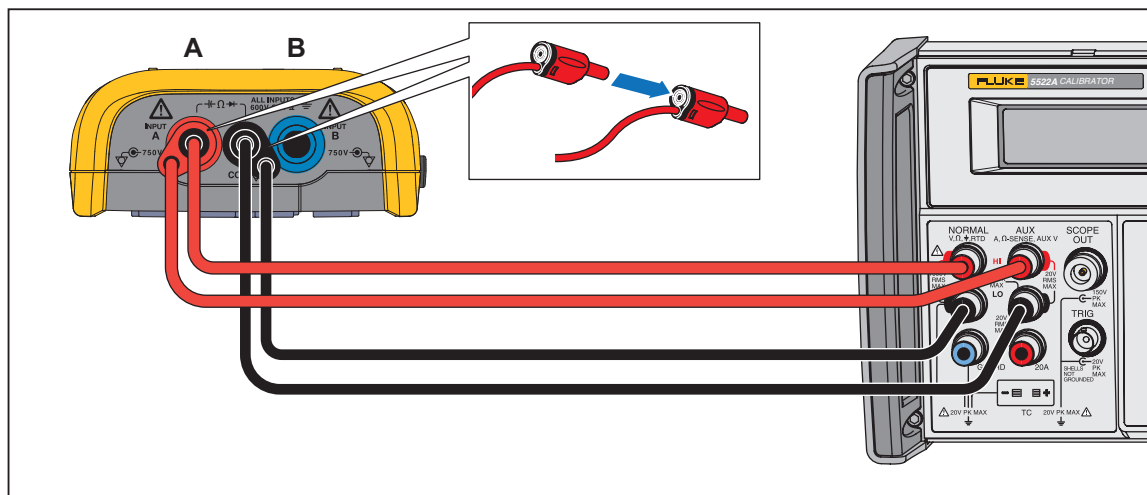

Figure 12. Four-Wire Ohms Calibration Connections

12. For each Calibration Step in Table 16:
 - a. On the Calibrator:
 - i. Supply the Input Value. Start with 50 Ω .
 - ii. Push **OPR**.
 - b. On the Test Tool:
 - i. Push **F2** to select the Calibration Step. Start with **Gain Ohm (CL0507) :IDLE**.
 - ii. Push **F3** to start the calibration

- Set the Calibrator to 0 V (zero).

Table 16. Ohm Gain Calibration Points

Calibration Step	Input Value
Gain Ohm (CL 0507)	50 Ω
Gain Ohm (CL 0508)	0.5 kΩ
Gain Ohm (CL 0509)	5 kΩ
Gain Ohm (CL 0510)	50 kΩ
Gain Ohm (CL 0511)	500 kΩ
Gain Ohm (CL 0512)	5 MΩ
Gain Ohm (CL 0513)	30 MΩ

Diode Zero, Gain

To do the Capacitance Gain calibration:

- Push **F2** to select calibration adjustment step **Diode Zero (CL 0520):IDLE**.
- Connect the Test Tool to the Calibrator as shown in Figure 13.

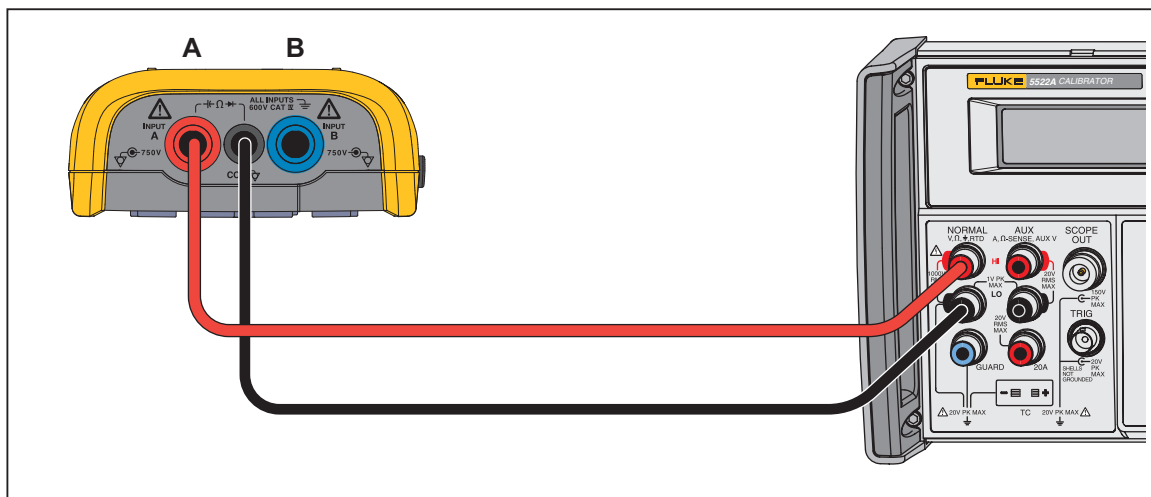

Figure 13. Capacitance Gain Calibration Input Connections

- Set up the Calibrator:
 - Supply 0 mV DC.
 - Push **OPR**.
- On the Test Tool:
 - Push **F3** to start the calibration.
 - Wait for **Diode Zero (CL 0520):READY** to show on the display.
 - Push **F2** to select calibration adjustment step **Gain Diode (CL 0521):IDLE**.
- Set the Calibrator to supply 1.25 V DC.
- Push **F3** to start the calibration.
- Wait until **Gain Diode (CL 0521):READY** shows on the display.

Capacitance Clamp and Zero

To do the capacitance clamp voltage and zero calibration:

1. Push **F2** to select calibration adjustment step **Clamp Zero (CL 0540):IDLE**.
2. Short CH A to COM.
3. Push **F3** to start the calibration.
4. Wait until **Clamp. Zero (CL 0540): READY** shows on the display.
5. Remove the CH 1 and CH 2 connections.
6. Push **F2** to select the calibration adjustment step **Clamp Zero (CL 0541):IDLE**.
7. Push **F3** to start the calibration.
8. Wait until **Cap. Zero (CL 0564): READY** shows on the display.
9. Continue to the next section.

Capacitance Gain

To do the Capacitance Gain calibration for each Calibration Step in Table 17:

1. Push **F2** to select the calibration step. Start with **Cap. Gain (CL 0565):IDLE**.
2. Connect the Test Tool to the Calibrator as shown in Figure 13.
3. Set up the Calibrator:
 - a. Supply the Input Value that corresponds to the Calibration Step.
 - b. Push **OPR**.
4. On the Test Tool:
 - a. Push **F3** to start the calibration.
 - b. Wait until **Cap. Gain (CL 0565):READY** shows on the display.
5. Continue to the next section.

Table 17. Capacitance Gain Calibration Points

Calibration Step	Input Value
Cap Gain (CL 0565)	50 nF
Cap Gain (CL 0566)	50 nF
Cap Gain (CL 0567)	5 μ F
Cap Gain (CL 0568)	50 μ F
Cap Gain (CL 0569)	500 μ F

Save Calibration Data and Exit

To save the calibration data and exit the Maintenance mode:

1. Remove all test leads from the Test Tool inputs. Do NOT turn off the Test Tool.
2. Push **F4** (EXIT). The Test Tool shows a message that the calibration is valid and prompts you to save the data.

Note

Calibration data valid indicates that the calibration adjustment procedure is performed correctly. It does not indicate that the Test Tool meets the characteristics listed in the Specifications section.

3. Push **F4** (YES) to save and exit.

Note

- The calibration number and date are updated only if the calibration data have been changed and the data are valid.
- The calibration data will change when a calibration adjustment is done. The data will not change when entering and then leaving the maintenance mode without doing a calibration adjustment.
- The calibration number and date will NOT be updated if you adjust the display contrast only.

If the Test Tool shows a warning that the data is not valid, return to Maintenance mode.

To return to the Maintenance mode:

1. Push **F3** (NO).
2. Push **F1** until **WarmingUp (CL 0200):IDLE** shows on the display.
3. Restart the calibration procedure on the Test Tool at *Warm Up and Pre-Calibration* on page 34.

To exit and save the INVALID calibration data:

1. Push **F4** (YES).

When turned on, the test tool prompts you to calibrate the Test Tool. The calibration date and number do not update. A complete recalibration must be done.

2. To exit and maintain the old calibration data, turn off the test tool.

Test Tool Disassembly

This section contains the required disassembling procedures. Protect the printed circuit board against damage.

⚠⚠ Warning

To prevent electric shock, disconnect test leads, probes and power supply from any live source and from the test tool itself. Always remove the battery pack before completely disassembling the test tool. If repair of the disassembled test tool under voltage is required, it shall be carried out only by qualified personnel using customary precautions against electric shock.

Required tools:

- #2 Phillips Screwdriver
- #10 Torx Screwdriver

Battery Pack Removal

⚠⚠ Warning

To prevent possible electrical shock, fire, or personal injury and for safe operation and maintenance of the Product:

- Batteries contain hazardous chemicals that can cause burns or explode. If exposure to chemicals occurs, clean with water and get medical aid.
- Use only the Fluke BP290 as a replacement battery.
- Do not disassemble the battery.
- Repair the Product before use if the battery leaks.
- Use only Fluke approved power adapters to charge the battery.
- Do not short the battery terminals together.
- Do not disassemble or crush battery cells and battery packs.
- Do not keep cells or batteries in a container where the terminals can be shorted.
- Do not put battery cells and battery packs near heat or fire. Do not put in sunlight.

To avoid loss of data, do one of the following before you remove the battery pack:

- Store the data on a computer or a USB device.
- Connect the power adapter.

To replace the battery pack:

1. Turn off the Test Tool.
2. Remove all probes and test leads.
3. Unlock the battery cover. See Figure 14.
4. Lift the battery cover and remove it from the Test Tool.
5. Lift one side of the battery pack and remove it from the Test Tool.
6. Install a good battery pack.
7. Place the battery cover into position and lock.

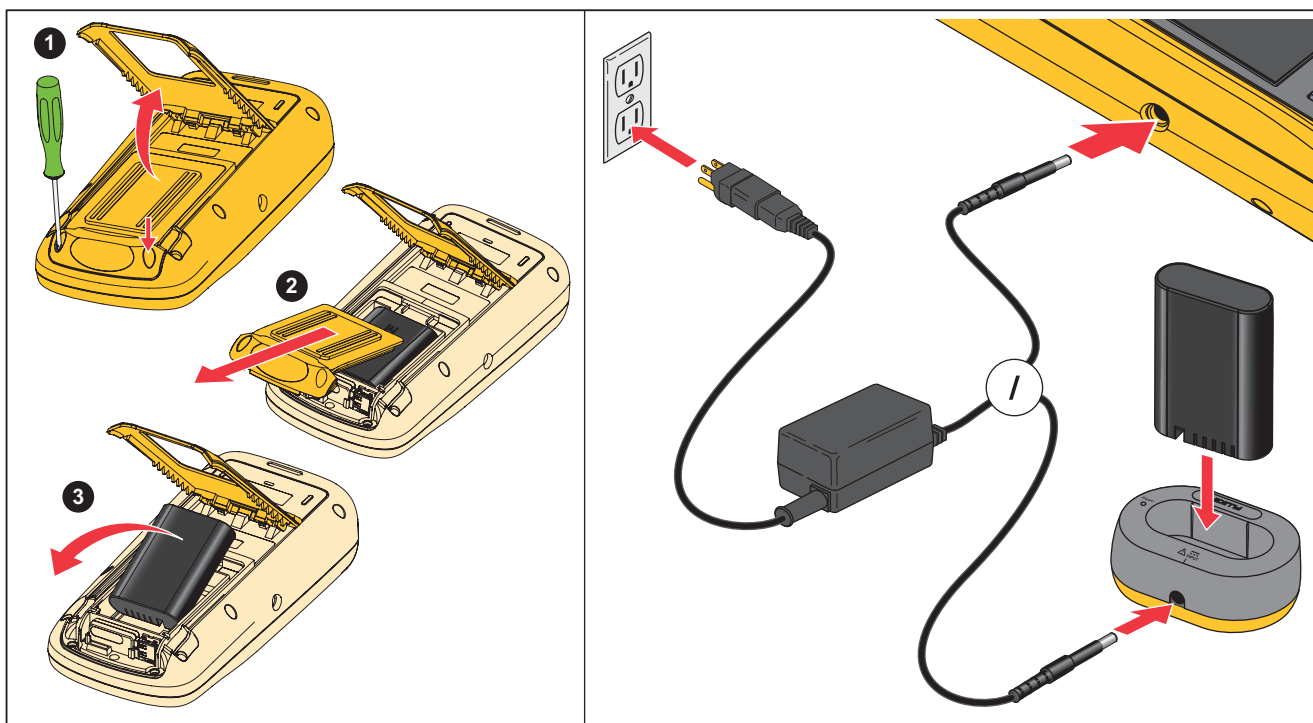

Figure 14. Battery Replacement/Charge

Bail Removal

To remove the bail:

1. With the bail open, press sideways on the bail until one of the pivots pops out. See Figure 14.
2. Remove the bail.

To reinsert:

1. With the bail in the open position, insert one pivot and press in and over on the bail.
2. Insert the second pivot into place.

Open the Test Tool

To open the test tool:

1. With the battery door removed, use a #10 Torx screwdriver to remove the seven screws that hold the case together (three on each side and one in the center near the bottom).
2. Pull the rear case perpendicular from the front case.



Static Awareness



Semiconductors and integrated circuits can be damaged by electrostatic discharge during handling. This notice explains how to minimize damage to these components.

1. Understand the problem.
 2. Learn the guidelines for proper handling.
 3. Use the proper procedures, packaging, and bench techniques.
- Follow these practices to minimize damage to static sensitive parts.

Warning

To prevent electric shock or personal injury. De-energize the product and all active circuits before opening a product enclosure, touching or handling any PCBs or components.



- Minimize handling.
- Handle static-sensitive parts by non-conductive edges.
- Do not slide static-sensitive components over any surface.
- When removing plug-in assemblies, handle only by non-conductive edges.
- Never touch open-edge connectors except at a static-free work station.

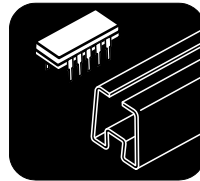

- Keep parts in the original containers until ready for use.
- Use static shielding containers for handling and transport.
- Avoid plastic, vinyl, and Styrofoam® in the work area.

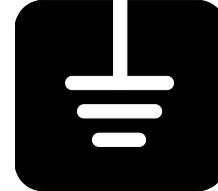

- Handle static-sensitive parts only at a static-free work station.
- Put shorting strips on the edge of the connector to help protect installed static-sensitive parts.
- Use anti-static type solder extraction tools only.
- Use grounded-tip soldering irons only.

Main PCA, Keypad, and Keypad Foil Removal

To remove the main PCA:

1. Remove the two screws that connect the main PCA to the top case (one on each side behind the input assembly).
2. Loosen the connector and disconnect the keypad foil from the Main PCA.
3. Lift the Main PCA from the ScopeMeter gently.
You will see a flat cable that connects the main PCA to the display.
4. Disconnect the flat cable from the display.
5. After the Main PCA has been removed, remove the keypad and keypad foil from the top case.

Display Assembly Removal

The display assembly has a dust seal that is friction fit to the top case.

To remove the display:

1. Pry gently on a corner of the display until the display assembly starts to move.
2. Lift the display out.

Maintenance

This section contains basic maintenance procedures.

⚠⚠ Warning

To prevent personal injury and for safe operation of the Product:

- **Have an approved technician repair the Product.**
- **Use only specified replacement parts.**
- **Before carrying out any maintenance, carefully read the safety information at the beginning of this manual.**
- **Do not operate the Product with covers removed or the case open. Hazardous voltage exposure is possible.**
- **Remove the input signals before you clean the Product.**

How to Clean

Clean the Test Tool with a damp cloth and a mild soap. Do not use abrasives, solvents, or alcohol. These can damage the text on the Test Tool.

Storage

If you store the Test Tool for an extended period of time, charge the Lithium-ion batteries before storage.

Battery Replacement

⚠⚠ Warning

To prevent possible electrical shock, fire, or personal injury and for safe operation and maintenance of the Product:

- **Batteries contain hazardous chemicals that can cause burns or explode. If exposure to chemicals occurs, clean with water and get medical aid.**
- **Use only the Fluke BP290 as a replacement battery.**
- **Do not disassemble the battery.**
- **Repair the Product before use if the battery leaks.**
- **Use only Fluke approved power adapters to charge the battery.**
- **Do not short the battery terminals together.**

Parts and Accessories

Test Tool parts and accessories are listed in Tables 18 and 19. To order parts and accessories, see *How to Contact Fluke* on page 1.

Table 18. Replacement Parts

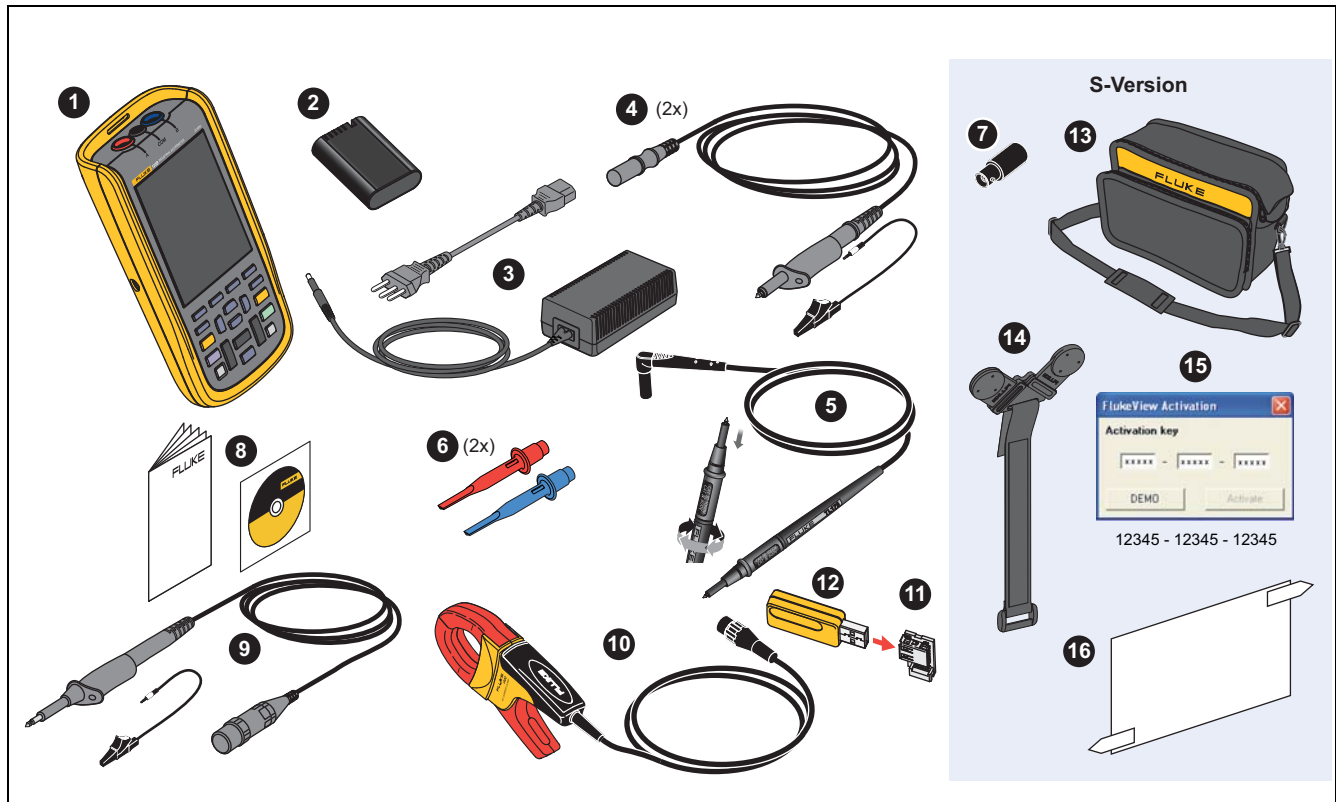

Item	Description	Order Code
1	Fluke Test Tool	
2	Rechargeable Li-ion Battery Pack	BP290
3	Switch Mode Power Supply, Adapter/Battery Charger	BC430/820
4	Set of two Shielded Test Leads (Red and Blue), designed for use only with the Fluke ScopeMeter® 120 series Test Tool. Set contains the Ground Lead with Alligator Clip (Black)	STL120-IV
5	Test Lead Black (for Grounding)	TL175
6	Hook Clips (red, blue)	HC120-II
7	See Table 19	
8	User Documentation	varies
9	VP41 10:1 Voltage Probe with hook clip and ground lead	VPS41
10	i400s AC Current Clamp	i400s
11	USB Angled Adapter	UA120B
12	WiFi USB Adapter	
13	See Table 19	
14	See Table 19	
15	See Table 19	
16	See Table 19	

Table 19. Optional Accessories

Item	Description	Order Code
Not shown	Bushealth Test Adapter: connects the probe tip to busses that use a DB9, RJ-45, or a M12 connector	BHT190
Software & Cable Carrying Case Kit (Supplied with Fluke 12x/S)		SCC 120B
Set contains the following parts:		
13	Soft Carrying Case	C120B
14	Magnetic Hanger	Fluke-1730-Hanger
15	FlukeView® ScopeMeter® Software for Windows®	SW90W
16	Screen Protector	C120B
7	Banana-to-BNC Adapters (black)	BB120-II (set of two)
13	Soft Carrying Case	C120B
14	Magnetic Hanger	Fluke-1730-Hanger
15	FlukeView® ScopeMeter® Software for Windows®	SW90W
16	Screen Protector	SP120B

User-replaceable parts are listed in Table 20. See *How to Contact Fluke* on page 1 to order parts.

⚠⚠ Warning

For safe operation and maintenance of the product, use only specified replacement parts.

Table 20. Replaceable Parts

Description	Fluke PN
Top Shield Sub-assembly, Fluke 12xB	4776379
Bottom Shield Sub-assembly, Fluke 12xB	4776387
Top Case Sub-assembly, Fluke 123B	4784944
Battery Door Sub-assembly, Fluke 12xB	4776400
Bottom Case Sub-assembly, Fluke 12xB	4776417
Case Screw	4715074
Fluke 12xB-8011, O-ring, 17 X 2	4715215
LCD 5.7 in, TFT Color, 640 x 480, White Led Backlight	4715455
Fluke-12xB-8002, Flex Circuit, Keypad	4715088
Fluke-12xB-8003, Switch, Keypad	4715095