

SSM1A120M7

solid state relay - DIN rail mount - input
90-280Vac, output 24-280Vac, 20A



Main

Range of product	Zelio Relay
Product or component type	Solid state relay
Device short name	SSM1
Number of phases	1 phase

Complementary

Mounting support	Symmetrical DIN rail
[In] rated current	20 A
Output voltage	24...280 V AC
Control circuit voltage	90...280 V AC
Contacts type and configuration	1 NO
Tightening torque	1.36...1.7 N.m for output 0.6...0.7 N.m for input
Connections - terminals	Screw terminals : 1 x 0.2...1 x 5.3 mm ² , (AWG 24...AWG 10) for output Screw terminals : 1 x 0.2...1 x 5.3 mm ² , (AWG 24...AWG 10) for input
Maximum capacitance	<= 8 pF for input/output
Insulation resistance	1000 MOhm at 500 V DC
Local signalling	LED green for input status
Switching voltage	10 V AC turn-off 90 V AC turn-on
Input current	2...10 mA
Solid state output type	Zero voltage switching SCR output
Load current	0.15...20 A
Transient overvoltage	600 V
Surge current	<= 250 A for 16.6 ms
Voltage drop	1.6 V on-state
Maximum I ² t for fusing	260 A ² .s for 8.3 ms
Leakage current	<= 10 mA off-state
DV/Dt	500 V/μs off-state at maximum voltage
Response time	40 ms turn-off 10 ms turn-on
Overvoltage category	III
Product weight	0.28 kg

The information provided in this documentation contains general descriptions and/or technical characteristics of the performance of the products contained herein. This documentation is not intended as a substitute for and is not to be used for determining suitability or reliability of these products for specific user applications. It is the duty of any such user or integrator to perform the appropriate and complete risk analysis, evaluation and testing of the products with respect to the relevant specific application or use thereof. Neither Schneider Electric Industries SAS nor any of its affiliates or subsidiaries shall be responsible or liable for misuse of the information contained herein.

Environment

Dielectric strength	4 kV AC for input or output to case 4 kV AC for input/output
Pollution degree	2
Standards	UL 508 IEC 60950-1 CSA C22.2 No 14
Product certifications	CSA UL EAC
Marking	CE CSA UL EAC
IP degree of protection	IP20
Ambient air temperature for operation	-40...80 °C
Ambient air temperature for storage	-40...125 °C

Dimensions

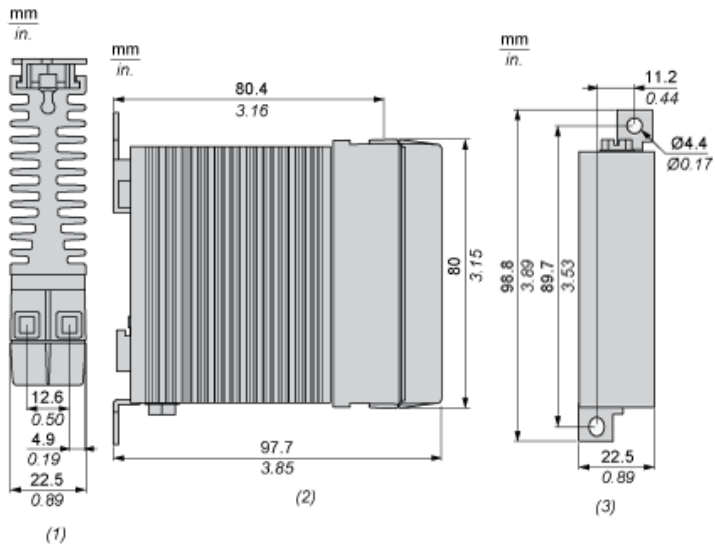

- (1) Top view
- (2) Side view
- (3) Front view

Derating Curves

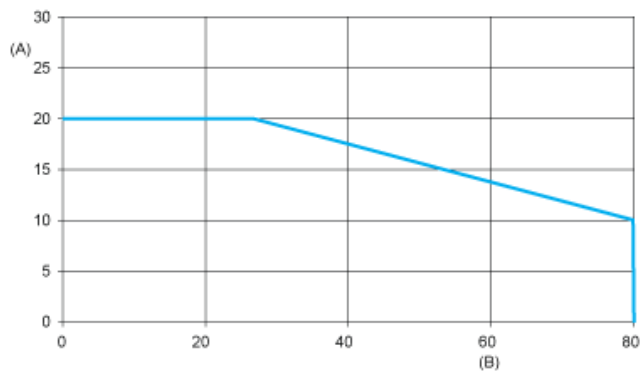

A : Load Current (Amperes)
B : Ambient Temperature (°C)