

FLUKE®

— **Hart Scientific**®

9142, 9143, 9144

*Field Metrology Well
Technical Guide*

Limited Warranty & Limitation of Liability

Each product from Fluke Corporation, Hart Scientific Division (“Hart”) is warranted to be free from defects in material and workmanship under normal use and service. The warranty period is one year for Field Metrology Wells. The warranty period begins on the date of the shipment. Parts, product repairs, and services are warranted for 90 days. The warranty extends only to the original buyer or end-user customer of a Hart authorized reseller, and does not apply to fuses, disposable batteries or to any other product, which in Hart’s opinion, has been misused, altered, neglected, or damaged by accident or abnormal conditions of operation or handling. Hart warrants that software will operate substantially in accordance with its functional specifications for 90 days and that it has been properly recorded on non-defective media. Hart does not warrant that software will be error free or operate without interruption. Hart does not warrant calibrations on the Field Metrology Well.

Hart authorized resellers shall extend this warranty on new and unused products to end-user customers only but have no authority to extend a greater or different warranty on behalf of Hart. Warranty support is available if product is purchased through a Hart authorized sales outlet or Buyer has paid the applicable international price. Hart reserves the right to invoice Buyer for importation costs of repairs/replacement parts when product purchased in one country is submitted for repair in another country.

Hart’s warranty obligation is limited, at Hart’s option, to refund of the purchase price, free of charge repair, or replacement of a defective product which is returned to a Hart authorized service center within the warranty period.

To obtain warranty service, contact your nearest Hart authorized service center or send the product, with a description of the difficulty, postage, and insurance prepaid (FOB Destination), to the nearest Hart authorized service center. Hart assumes no risk for damage in transit. Following warranty repair, the product will be returned to Buyer, transportation prepaid (FOB Destination). If Hart determines that the failure was caused by misuse, alteration, accident or abnormal condition or operation or handling, Hart will provide an estimate or repair costs and obtain authorization before commencing the work. Following repair, the product will be returned to the Buyer transportation prepaid and the Buyer will be billed for the repair and return transportation charges (FOB Shipping Point).

THIS WARRANTY IS BUYER’S SOLE AND EXCLUSIVE REMEDY AND IS IN LIEU OF ALL OTHER WARRANTIES, EXPRESS OR IMPLIED, INCLUDING BUT NOT LIMITED TO ANY IMPLIED WARRANTY OF MERCHANTABILITY OR FITNESS FOR A PARTICULAR PURPOSE. HART SHALL NOT BE LIABLE FOR ANY SPECIAL, INDIRECT, INCIDENTAL, OR CONSEQUENTIAL DAMAGES OR LOSSES, INCLUDING LOSS OF DATA, WHETHER ARISING FROM BREACH OF WARRANTY OR BASED ON CONTRACT, TORT, RELIANCE OR ANY OTHER THEORY.

Since some countries or states do not allow limitation of the term of an implied warranty, or exclusion or limitation of incidental or consequential damages, the limitations and exclusions of this warranty may not apply to every buyer. If any provision of this Warranty is held invalid or unenforceable by a court of competent jurisdiction, such holding will not affect the validity or enforceability of any other provision.

Fluke Corporation, Hart Scientific Division

799 E. Utah Valley Drive • American Fork, UT 84003-9775 • USA
Phone: +1.801.763.1600 • Telefax: +1.801.763.1010
E-mail: support@hartscientific.com

www.hartscientific.com

Specifications subject to change without notice. • Copyright © 2007 • Printed in USA

Table of Contents

1	Before You Start	1
1.1	Introduction.....	1
1.2	Unpacking	2
1.3	Symbols Used.....	3
1.4	Safety Information.....	4
1.4.1	Warnings	5
1.4.2	Cautions	7
1.5	CE Comments.....	8
1.5.1	EMC Directive	8
1.5.2	Immunity Testing	8
1.5.3	Emission Testing.....	9
1.5.4	Low Voltage Directive (Safety)	9
1.6	Authorized Service Centers.....	9
2	Specifications and Environmental Conditions.....	11
2.1	Specifications	11
2.2	Environmental Conditions	13
3	Quick Start.....	15
3.1	Setup.....	15
3.2	Parts and Controls	16
3.2.1	Display Panel	17
3.2.2	Display	18
3.2.3	Power Panel	20
3.2.4	-P Option Panel (-P models only).....	22
3.3	Languages.....	24
3.3.1	Language Selection	24
3.3.2	Reset to English Language	25
4	Menu Structure.....	27
4.1	Temp Setup Menu.....	27
4.2	Prog Menu	28
4.2.1	Switch Test Parameters.....	29
4.2.2	Switch Test Description.....	29
4.3	System Menu	31
4.4	Input Setup (-P only).....	32

5	Controller operation.....	33
5.1	Main Screen.....	33
5.2	Main Menu.....	34
5.2.1	Temp Setup.....	34
5.2.2	Prog Menu.....	36
5.2.3	System Menu.....	43
5.2.4	INPUT SETUP (-P model only).....	49
6	Digital communication interface.....	55
6.1	Wiring.....	55
6.1.1	Setup.....	55
6.1.2	Serial Operation.....	55
6.2	Command Syntax.....	56
6.3	Commands by Function or Group.....	57
6.4	Serial Commands - Alphabetic Listing.....	61
7	Calibration of your Field Metrology Well.....	83
7.1	General.....	83
7.2	Terminology.....	83
7.3	Fundamentals.....	83
7.4	Procedure.....	87
7.4.1	Readout Calibration/Tests.....	87
7.4.2	Readout Specifications.....	87
7.4.3	UUT Thermocouple Calibration.....	87
7.4.4	Thermocouple Accuracy Test.....	87
7.4.5	Thermocouple Reference Junction Accuracy Test.....	88
7.4.6	Thermocouple Accuracy Alignment.....	88
7.4.7	Thermocouple Reference Junction Accuracy Alignment.....	89
7.4.8	Reference Accuracy Test.....	89
7.4.9	UUT PRT 4-wire Test.....	90
7.4.10	UUT PRT 3-wire Test.....	91
7.4.11	Reference Accuracy Alignment.....	91
7.4.12	UUT 4-20mA Input Calibration.....	92
7.4.13	4-20mA Accuracy Test.....	92
7.4.14	24V Source Test.....	93
7.4.15	4-20mA Accuracy Alignment.....	93
7.5	Heat Source Calibration/Test.....	93
7.5.1	Axial Gradient Test.....	95
7.5.2	Accuracy Test.....	96

7.5.3	Stability Test	96
7.5.4	Hysteresis Calculation.....	97
7.5.5	Uniformity Alignment.....	98
7.5.6	Accuracy Alignment.....	99
8	Troubleshooting	101
9	Maintenance	103
9.1	Field Metrology Well Performance Analysis	103

Tables

Table 1 Symbols used.....	3
Table 2 Base Unit Specifications	11
Table 3 -P Option Specifications	12
Table 4 Matching Certificate Values to 917X ITS-90 Coefficients.....	51
Table 5 Setting Coefficients Rtpw, a8, b8, and b4.....	52
Table 6 Commands by Function or Group.....	57
Table 7 PROG:SEQ:PAR parameters.....	69
Table 8 PROG:SWIT:PAR parameters	70
Table 9 Test equipment specifications.....	84
Table 10 Standard resistor specifications.....	84
Table 11 Thermocouple Testing Process.....	87
Table 12 Reference Probe and UUT PRT Input Process	89
Table 13 UUT 4-20 mA Calibration Steps	92
Table 14 Heat Source Calibration/Test Sequence	94
Table 15 Axial Gradient Limits	94
Table 16 Heat Source As Found Data/As Left Data Specifications	97
Table 17 Accuracy alignment parameters.....	100
Table 18 Troubleshooting, problems, causes and solutions.....	101

Figures

Figure 1 Clamp-on ferrite installation	9
Figure 2 914X Field Metrology Well	16
Figure 3 Display panel and keys	18
Figure 4 914X display	19
Figure 5 9142 power panel.....	21
Figure 6 9143 and 9144 power panel.....	21
Figure 7 -P option panel	22
Figure 8 Probe connector wiring	23
Figure 9 Jumper locations for 3-wire and 2-wire connections.....	24
Figure 10 Steps to language selection	25
Figure 11 Main Menu - Temp SetUp	27
Figure 12 Main Menu - Prog Menu	28
Figure 13 Auto and manual switch test operation example	30
Figure 14 Main Menu - System Menu	31
Figure 15 Main Menu - Input Setup	32
Figure 16 Schematic diagram showing the deadband in a temperature switch as it closes and opens with temperature changes.....	39
Figure 17 RS-232 wiring	56
Figure 18 Readout calibration flow chart.....	85
Figure 19 Heat source calibration flow chart.....	86
Figure 20 PRT and insert orientation during heat source calibration.	95

1 Before You Start

1.1 Introduction

Field Metrology Wells (9142, 9143, and 9144) are designed to be reliable, stable heat sources that can be used in the field or laboratory. They offer accuracy, portability, and speed for nearly every field calibration application. The instruments have been designed with the field user in mind and are easy to use while maintaining stability, uniformity, and accuracy comparable to some laboratory instruments.

Special built-in features make Field Metrology Wells extremely adaptable. The exclusive Voltage Compensation allows the technician to plug into mains power with voltage from 90 V ac to 250 V ac without degradation to the instrument. The Ambient Temperature Compensation (Patent Pending) provides the largest operating range in the industry (0°C to 50°C) with the largest guaranteed temperature range (13°C to 33°C). The Gradient Temperature Compensation (Patent Pending) keeps the axial gradient within specification over the entire temperature range of the instrument and over the specified guaranteed operating temperature range. These combined features along with the rugged design, light weight, and small size make this line of instruments ideal for field applications.

Unique Patent Pending safety features make these the safest field heat sources available. The unique Air Flow Design (Patent Pending) keeps the probe handle cool protecting delicate instruments and the user. The Block Temperature Indicator (Patent Pending) shows the user when the well temperature is above 50°C letting the user know when it is safe to remove the insert or move the instrument. The indicator light illuminates when the instrument is energized and the well is above 50°C. If the instrument is removed from mains power, the indicator light flashes until the well has cooled to less than 50°C.

The optional “Process” version (“914X-P”) combines the heat source with a built-in readout eliminating the need for the technician to take two instruments to the field. The readout is perfect for transmitter loop, comparison calibration, or a simple check of a thermocouple sensor. There is no need to carry additional tools into the field with the “Process” option of a built-in readout for resistance, voltage, and mA measurement, 24V loop power, and on-board documentation. The convenient smart reference connector automatically transfers and stores the probe coefficients.

The Field Metrology Wells’ controller uses a PRT sensor and thermoelectric modules or heaters to achieve stable, uniform temperatures throughout the block.

The LCD display continuously shows many useful operating parameters including the block temperature, the current set-point, block stability, and heating and cooling status. For the Process version, the reference temperature and secondary input type (UUT) readings are displayed. The display can be set to show the information in one of eight different languages; English, Japanese, Chinese, German, Spanish, French, Russian, and Italian.

The instrument’s rugged design and special features make them ideal for the field or the laboratory. With proper use, the instrument provides continued accurate calibration of temperature

sensors and devices. Before use, the user should be familiar with the warnings, cautions, and operating procedures of the calibrator as described in the User's Guide.

1.2 Unpacking

Unpack the instrument carefully and inspect it for any damage that may have occurred during shipment. If there is shipping damage, notify the carrier immediately.

Verify that the following components are present:

9142

- 9142 Field Metrology Well
- 9142-INSX Insert (X=A, B, C, D, E, or F)
- Power Cord
- RS-232 Cable
- User Guide
- Technical Manual CD
- Report of Calibration and calibration label
- 6-pin DIN Connector (-P model only)
- Test Lead Kit (-P model only)
- Well Insulator
- Clamp-on ferrites (3) [-P model only]
- Tongs (insert removal tool)
- 9930 Interface-it Software and User's Guide

9143

- 9143 Field Metrology Well
- 9143-INSX Insert (X=A, B, C, D, E, or F)
- Power Cord
- RS-232 Cable
- User Guide
- Technical Manual CD
- Report of Calibration and calibration label
- 6-pin DIN Connector (-P model only)
- Test Lead Kit (-P model only)
- Clamp-on ferrites (3) [-P model only]
- Tongs (insert removal tool)
- 9930 Interface-it Software and User's Guide

9144







- 9144 Field Metrology Well
- 9144-INSX Insert (X=A, B, C, D, E, or F)
- Power Cord
- RS-232 Cable
- User Guide
- Technical Manual CD
- Report of Calibration and calibration label
- 6-pin DIN Connector (-P model only)
- Test Lead Kit (-P model only)
- Clamp-on ferrites (3) [-P model only]
- Tongs (insert removal tool)
- 9930 Interface-it Software and User's Guide

If all items are not present, contact an Authorized Service Center (see Section 1.6 Authorized Service Centers on page 9).

1.3 Symbols Used











Table 1 lists the International Electrical Symbols. Some or all of these symbols may be used on the instrument or in this guide.

Table 1 *Symbols used*

Symbol	Description
	AC (Alternating Current)
	AC-DC
	Battery
	Complies with European Union directives
	DC
	Double Insulated

914X Field Metrology Wells

Safety Information

Symbol	Description
	Electric Shock
	Fuse
	PE Ground
	Hot Surface (Burn Hazard)
	Read the User's Guide (Important Information)
	Off
	On
	Canadian Standards Association
	C-TICK Australian EMC mark
	The European Waste Electrical and Electronic Equipment (WEEE) Directive (2002/96/EC) mark.

1.4 Safety Information

Field Metrology Wells are designed in accordance with IEC 61010-1, IEC 61010-2-010 and CAN/CSA 22.2 No 61010.1-04. Use this instrument only as specified in this manual. Otherwise, the protection provided by the instrument may be impaired. Refer to the safety information in the Warnings and Cautions sections below.

The following definitions apply to the terms “Warning” and “Caution”.

- “Warning” identifies conditions and actions that may pose hazards to the user.
- “Caution” identifies conditions and actions that may damage the instrument being used.

1.4.1 Warnings

To avoid personal injury, follow these guidelines.

GENERAL

DO NOT use this instrument in environments other than those listed in the User's Guide.

Inspect the instrument for damage before each use. Inspect the case. Look for cracks or missing plastic. **DO NOT** use the instrument if it appears damaged or operates abnormally.

Follow all safety guidelines listed in the User's Guide.

Calibration equipment should only be used by trained personnel.

If this equipment is used in a manner not specified by the manufacturer, the protection provided by the equipment may be impaired.

Before initial use, or after transport, or after storage in humid or semi-humid environments, or anytime the instrument has not been energized for more than 10 days, the instrument needs to be energized for a "dry-out" period of 2 hours before it can be assumed to meet all of the safety requirements of the IEC 1010-2. If the product is wet or has been in a wet environment, take necessary measures to remove moisture prior to applying power such as storage in a low humidity temperature chamber operating at 50°C for 4 hours or more.

DO NOT use this instrument for any application other than calibration work. The instrument was designed for temperature calibration. Any other use of the instrument may cause unknown hazards to the user.

DO NOT place the instrument under a cabinet or other structure. Overhead clearance is required. Always leave enough clearance to allow for safe and easy insertion and removal of probes.

Use of this instrument at HIGH TEMPERATURES for extended periods of time requires caution.

Completely unattended high temperature operation is not recommended due to safety hazards that can arise.

This instrument is intended for indoor use only.

Follow all safety procedures for the test and calibration equipment you use.

If used, inspect the test leads for damaged insulation or exposed metal. Check for test lead continuity. Replace damaged test leads as necessary.

Do not use the instrument if it operates abnormally. Protection may be impaired. When in doubt, have the instrument serviced.

Do not apply more than the rated voltage, as marked on the instrument, between terminals or between any terminal and earth ground.

Never touch the probes to a voltage source when the test leads are plugged into the current terminals.

Select the proper function and range for each measurement.

Disconnect the test leads before changing to another measure or source function.

DO NOT operate the Field Metrology Well around explosive gas, vapor, or dust.

DO NOT operate instrument at orientations other than upright. Tilting the instrument or laying it down on its side during use could create a fire hazard.

BURN HAZARD

The instrument is equipped with a Block Temperature Indicator (front panel LED HOT indicator – Patent Pending) even when the instrument is unplugged. When the indicator is flashing, the instrument is disconnected from mains power and the temperature of the block is above 50°C. When the indicator is illuminated, always on, the instrument is powered and the block temperature is above 50°C.

DO NOT turn the instrument upside down with the inserts in place; the inserts will fall out.

DO NOT operate near flammable materials.

Use of this instrument at HIGH TEMPERATURES for extended periods of time requires caution.

DO NOT touch the well access surface of the instrument.

The block vent may be very hot due to the fan blowing across the heater block of the instrument.

The temperature of the well access is the same as the actual display temperature, e.g. if the instrument is set to 600°C and the display reads 600°C, the well is at 600°C.

Probes and inserts may be hot and should only be inserted and removed from the instrument when the instrument indicates temperatures less than 50°C.

DO NOT turn off the instrument at temperatures higher than 100°C. This could create a hazardous situation. Select a set-point less than 100°C and allow the instrument to cool before turning it off.

The high temperatures present in Field Metrology Wells designed for operation at 300°C and higher may result in fires and severe burns if safety precautions are not observed.

ELECTRICAL HAZARD

These guidelines must be followed to ensure that the safety mechanisms in this instrument operate properly. This instrument must be plugged into an AC only electric outlet according to Table 2, Specifications . The power cord of the instrument is equipped with a three-pronged grounding plug for your protection against electrical shock hazards. It must be plugged directly into a properly grounded three-prong receptacle. The receptacle must be installed in accordance with local codes and ordinances. Consult a qualified electrician. **DO NOT** use an extension cord or adapter plug.

If supplied with user accessible fuses, always replace the fuse with one of the same rating, voltage, and type.

Always replace the power cord with an approved cord of the correct rating and type.

HIGH VOLTAGE is used in the operation of this equipment. SEVERE INJURY or DEATH may result if personnel fail to observe safety precautions. Before working inside the equipment, turn power off and disconnect power cord.

-P Model Only

When using test leads, keep fingers behind the finger guards on the test leads.

DO NOT apply more than the rated voltage, as marked on the instrument, between the terminals, or between any terminal and earth ground (30 V 24 mA max all terminals).

Never touch the probe to a voltage source when the test leads are plugged into current terminals.

Select the proper function and range for your measurement.

Inspect the test leads for damaged insulation or exposed metal. Check test leads continuity. Replace damaged test leads before you use the calibrator.

1.4.2 Cautions

To avoid possible damage to the instrument, follow these guidelines:

DO NOT leave the inserts in the instrument for prolonged periods. Due to the high operating temperatures of the instrument, the inserts should be removed after each use and buffed with a Scotch-Brite® pad or emery cloth (see Section 9 Maintenance on page 103).

Always operate this instrument at room temperature between 41°F and 122°F (5°C to 50°C). Allow sufficient air circulation by leaving at least 6 inches (15 cm) of clearance around the instrument. Overhead clearance of 1 meter (3 ft) is required. **DO NOT** place instrument under any structure.

Component lifetime can be shortened by continuous high temperature operation.

DO NOT apply any type of voltage to the display hold terminals. Applying a voltage to the terminals may cause damage to the controller.

DO NOT use fluids to clean out the well. Fluids could leak into electronics and damage the instrument.

Never introduce any foreign material into the probe hole of the insert. Fluids, etc. can leak into the instrument causing damage.

Unless recalibrating the instrument **DO NOT** change the values of the calibration constants from the factory set values. The correct setting of these parameters is important to the safety and proper operation of the calibrator.

DO NOT allow the probe sheath or inserts to drop into the well. This type of action can cause a shock to the sensor and affect the calibration.

The instrument and any thermometer probes used with it are sensitive instruments that can be easily damaged. Always handle these devices with care. **DO NOT** allow them to be dropped, struck, stressed, or overheated.

DO NOT operate this instrument in an excessively wet, oily, dusty, or dirty environment. Always keep the well and inserts clean and clear of foreign material.

The Field Metrology Well is a precision instrument. Although it has been designed for optimum durability and trouble free operation, it must be handled with care. Always carry the instrument in an upright position to prevent the inserts from dropping out. The convenient handle allows for hand carrying the instrument.

If a mains supply power fluctuation occurs, immediately turn off the instrument. Power bumps from brown-outs could damage the instrument. Wait until the power has stabilized before re-energizing the instrument.

The probe and the block may expand at different rates. Allow for probe expansion inside the well as the block heats. Otherwise, the probe may become stuck in the well.

Most probes have handle temperature limits. If the probe handle limits are exceeded, the probe may be permanently damaged. Due to a unique Air Flow Design (Patent Pending), Field Metrology Wells protect the probe handle temperature and provide a safer temperature handle for the user.

1.5 CE Comments

1.5.1 EMC Directive

Hart Scientific's equipment has been tested to meet the European Electromagnetic Compatibility Directive (EMC Directive, 89/336/EEC). The Declaration of Conformity for your instrument lists the specific standards to which the instrument was tested.

The instrument was designed specifically as a test and measuring device. Compliance to the EMC directive is through IEC 61326-1 Electrical equipment for measurement, control and laboratory use.

As noted in the IEC 61326-1, the instrument can have varying configurations. The instrument was tested in a typical configuration with shielded RS-232 cables.

1.5.2 Immunity Testing

Using Clamp-On Ferrites

For the -P model only, clamp-on ferrites are provided for use in improving its electromagnetic (EM) immunity in environments of excessive EM interference. During EMC testing we found that ferrites clamped around probe cables for the Reference PRT, the PRT/RTD input, and the thermocouple (TC) input reduced the risk the EM interference affects measurements. Therefore,

we recommend that the clamp-on ferrites provided be used on the cables of probes attached to the readout, especially if the product is used near sources of EM interference such as heavy industrial equipment.

To attach a ferrite to a probe cable, make a loop in the cable near the connector and clamp the ferrite around half of the loop as shown in the diagram. The ferrite can be easily snapped open and moved to a new probe when needed.

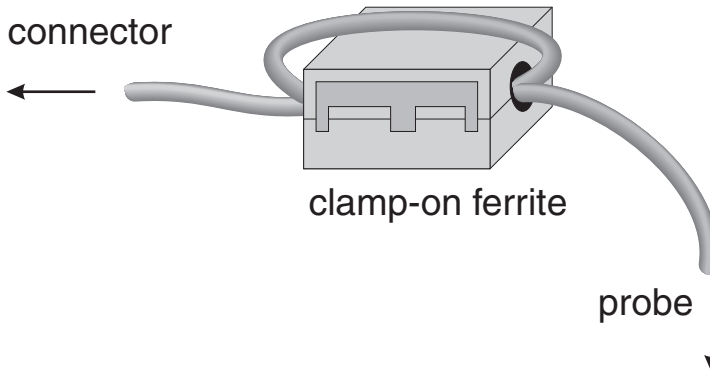

Figure 1 Clamp-on ferrite installation

1.5.3 Emission Testing

The instrument fulfills the limit requirements for Class A equipment. The instrument was not designed to be used in domestic establishments.

1.5.4 Low Voltage Directive (Safety)

In order to comply with the European Low Voltage Directive (2006/95/EC), Hart Scientific equipment has been designed to meet the EN 61010-1 and the EN 61010-2-010 standards.

1.6 Authorized Service Centers

Please contact one of the following Authorized Service Centers to coordinate service on your Hart product:

Fluke Corporation

Hart Scientific Division

799 E. Utah Valley Drive
American Fork, UT 84003-9775
USA

Phone: +1.801.763.1600
Telefax: +1.801.763.1010
E-mail: support@hartscientific.com

914X Field Metrology Wells

Authorized Service Centers

Fluke Nederland B.V.

Customer Support Services
Science Park Eindhoven 5108
5692 EC Son
NETHERLANDS

Phone: +31-402-675300
Telefax: +31-402-675321
E-mail: ServiceDesk@fluke.nl

Fluke Int'l Corporation

Service Center - Instrimpex
Room 2301 Sciteck Tower
22 Jianguomenwai Dajie
Chao Yang District
Beijing 100004, PRC
CHINA

Phone: +86-10-6-512-3436
Telefax: +86-10-6-512-3437
E-mail: xingye.han@fluke.com.cn

Fluke South East Asia Pte Ltd.

Fluke ASEAN Regional Office
Service Center
60 Alexandra Terrace #03-16
The Comtech (Lobby D)
118502
SINGAPORE

Phone: +65-6799-5588
Telefax: +65-6799-5589
E-mail: anthony.ng@fluke.com

When contacting a Service Centers for support, please have the following information available:

- Model Number
- Serial Number
- Voltage
- Complete description of the problem

2 Specifications and Environmental Conditions

2.1 Specifications

Table 2 Base Unit Specifications

Base Unit Specifications			
	9142	9143	9144
Temperature Range at 23 °C	-25 °C to 150 °C (-13 °F to 302 °F)	33 °C to 350 °C (91 °F to 662 °F)	50 °C to 660 °C (122 °F to 1220 °F)
Display Accuracy	± 0.2 °C Full Range	± 0.2 °C Full Range	± 0.35 °C at 50 °C ± 0.35 °C at 420 °C ± 0.5 °C at 660 °C
Stability	± 0.01 °C Full Range	± 0.02 °C at 33 °C ± 0.02 °C at 200 °C ± 0.03 °C at 350 °C	± 0.03 °C at 50 °C ± 0.05 °C at 420 °C ± 0.05 °C at 660 °C
Axial Uniformity at 40 mm (1.6 in)	± 0.05 °C Full Range	± 0.04 °C at 33 °C ± 0.1 °C at 200 °C ± 0.2 °C at 350 °C	± 0.05 °C at 50 °C ± 0.35 °C at 420 °C ± 0.5 °C at 660 °C
Axial Uniformity at 60 mm (2.4 in)	± 0.07 °C Full Range	± 0.04 °C at 33 °C ± 0.2 °C at 200 °C ± 0.25 °C at 350 °C	± 0.1 °C at 50 °C ± 0.6 °C at 420 °C ± 0.8 °C at 660 °C
Radial Uniformity	± 0.01 °C Full Range	± 0.01 °C at 33 °C ± 0.015 °C at 200 °C ± 0.02 °C at 350 °C	± 0.02 °C at 50 °C ± 0.05 °C at 420 °C ± 0.1 °C at 660 °C
Loading Effect (with a 6.35 mm reference probe and three 6.35 mm probes)	± 0.006 °C Full Range	± 0.015 °C Full Range	± 0.015 °C at 50 °C ± 0.025 °C at 420 °C ± 0.035 °C at 660 °C
Loading Effect (versus display with 6.35 mm probes)	± 0.08 °C Full Range	± 0.2 °C Full Range	± 0.1 °C at 50 °C ± 0.2 °C at 420 °C ± 0.2 °C at 660 °C
Hysteresis	0.025 °C	0.03 °C	0.1 °C
Operating Conditions	0 °C to 50 °C, 0 % to 90 % RH (non-condensing)		
Environmental conditions for all specifications except temperature range	13 °C to 33 °C		
Immersion (Well) Depth	150 mm (5.9 in)		
Insert OD	30 mm (1.18 in)	25.3 mm (1.00 in)	24.4 mm (0.96 in)
Heating Time	16 min: 23 °C to 140 °C 23 min: 23 °C to 150 °C 25 min: -25 °C to 150 °C	5 min: 33 °C to 350 °C	15 min: 50 °C to 660 °C
Cooling Time	15 min: 23 °C to -25 °C 25 min: 150 °C to -23 °C	32 min: 350 °C to 33 °C 14 min: 350 °C to 100 °C	35 min: 660 °C to 50 °C 25 min: 660 °C to 100 °C
Resolution	0.01 °		
Display	LCD, °C or °F user-selectable		
Key Pad	Arrows, Menu, Enter, Exit, 4 soft keys		
Size (H x W x D)	290 mm x 185 mm x 295 mm (11.4 x 7.3 x 11.6 in)		

914X Field Metrology Wells

Specifications

Base Unit Specifications			
	9142	9143	9144
Weight	8.16 kg (18 lbs)	7.3 kg (16 lbs)	7.7 kg (17 lbs)
Power Requirements	100 V to 115 V ($\pm 10\%$) 50/60 Hz, 635 W 230 V ($\pm 10\%$) 50/60 Hz, 575 W	100 V to 115 V ($\pm 10\%$), 50/60 Hz, 1400 W 230 V ($\pm 10\%$), 50/60 Hz, 1800 W	
System Fuse Ratings	115 V: 6.3 A T 250 V 230 V: 3.15 A T 250 V	115 V: 15 A F 250 V 230 V: 10 A F 250 V	
4–20 mA Fuse (-P model only)	50 mA F 250V		
Computer Interface	RS-232 and 9930 Interface-it control software included		
Safety	EN 61010-1:2001, CAN/CSA C22.2 No. 61010.1-04		

Table 3 -P Option Specifications

-P Specifications	
Built-in Reference Thermometer Readout Accuracy (4-Wire Reference Probe)[†]	$\pm 0.013\text{ }^{\circ}\text{C}$ at $-25\text{ }^{\circ}\text{C}$ $\pm 0.015\text{ }^{\circ}\text{C}$ at $0\text{ }^{\circ}\text{C}$ $\pm 0.020\text{ }^{\circ}\text{C}$ at $50\text{ }^{\circ}\text{C}$ $\pm 0.025\text{ }^{\circ}\text{C}$ at $150\text{ }^{\circ}\text{C}$ $\pm 0.030\text{ }^{\circ}\text{C}$ at $200\text{ }^{\circ}\text{C}$ $\pm 0.040\text{ }^{\circ}\text{C}$ at $350\text{ }^{\circ}\text{C}$ $\pm 0.050\text{ }^{\circ}\text{C}$ at $420\text{ }^{\circ}\text{C}$ $\pm 0.070\text{ }^{\circ}\text{C}$ at $660\text{ }^{\circ}\text{C}$
Reference Resistance Range	0 ohms to 400 ohms
Reference Resistance Accuracy[‡]	0 ohms to 42 ohms: ± 0.0025 ohms 42 ohms to 400 ohms: ± 60 ppm of reading
Reference Characterizations	ITS-90, CVD, IEC-751, Resistance
Reference Measurement Capability	4-wire
Reference Probe Connection	6 Pin Din with Infocon Technology
Built-in RTD Thermometer Readout Accuracy	NI-120: $\pm 0.015\text{ }^{\circ}\text{C}$ at $0\text{ }^{\circ}\text{C}$ PT-100 (385): $\pm 0.02\text{ }^{\circ}\text{C}$ at $0\text{ }^{\circ}\text{C}$ PT-100 (3926): $\pm 0.02\text{ }^{\circ}\text{C}$ at $0\text{ }^{\circ}\text{C}$ PT-100 (JIS): $\pm 0.02\text{ }^{\circ}\text{C}$ at $0\text{ }^{\circ}\text{C}$
RTD Resistance Range	0 ohms to 400 ohms
Resistance Accuracy[‡]	0 ohms to 25 ohms: ± 0.002 ohms 25 ohms to 400 ohms: ± 80 ppm of reading
RTD Characterizations	PT-100 (385),(JIS),(3926), NI-120, Resistance
RTD Measurement Capability	2-,3-,4-wire RTD w/ Jumpers only
RTD Connection	4 terminal input

-P Specifications	
Built-in TC Thermometer Readout Accuracy	Type J: ± 0.7 °C at 660 °C Type K: ± 0.8 °C at 660 °C Type T: ± 0.8 °C at 400 °C Type E: ± 0.7 °C at 660 °C Type R: ± 1.4 °C at 660 °C Type S: ± 1.5 °C at 660 °C Type M: ± 0.6 °C at 660 °C Type L: ± 0.7 °C at 660 °C Type U: ± 0.75 °C at 600 °C Type N: ± 0.9 °C at 660 °C Type C: ± 1.1 °C at 660 °C
TC Millivolt Range	-10 mV to 75 mV
Voltage Accuracy	0.025 % of reading +0.01mV
Internal Cold Junction Compensation Accuracy	± 0.35 °C (ambient of 13 °C to 33 °C)
TC Connection	Small connectors
Built-in mA Readout Accuracy	0.02% of reading + 0.002 mA
mA Range	Cal 4-22 mA, Spec 4-24 mA
mA Connection	2 terminal input
Loop Power Function	24 VDC loop power
Built-in Electronics Temperature Coefficient (0 °C to 13 °C, 33 °C to 50 °C)	± 0.005 % of range per °C
<p>¹The temperature range may be limited by the reference probe connected to the readout. The Built-In Reference Accuracy does not include the sensor probe accuracy. It does not include the probe uncertainty or probe characterization errors.</p> <p>²Measurement accuracy specifications apply within the operating range and assume 4-wires for PRTs. With 3-wire RTDs add 0.05 ohms to the measurement accuracy plus the maximum possible difference between the resistances of the lead wires.</p>	

2.2 Environmental Conditions

Although the instrument has been designed for optimum durability and trouble-free operation, it must be handled with care. The instrument should not be operated in an excessively dusty or dirty environment. Maintenance and cleaning recommendations can be found in the Maintenance section. The instrument operates safely under the following environmental conditions:

- ambient temperature range: 0-50°C (32-122°F)
- ambient relative humidity: 0 % to 90 % (non-condensing)
- mains voltage: within $\pm 10\%$ of nominal
- vibrations in the calibration environment should be minimized
- indoor use only

3 Quick Start

3.1 Setup



Note: The instrument will not heat, cool, or control until the “SET PT.” parameter is “Enabled”.

Place the calibrator on a flat surface with at least 6 inches of free space around the instrument. Overhead clearance is required. **DO NOT** place under a cabinet or structure.

Plug the instrument power cord into a mains outlet of the proper voltage, frequency, and current capability (see Section 2.1 Specifications on page 11 for power details). Observe that the nominal voltage corresponds to that indicated on the front of the calibrator.

Carefully place the insert into the well. Inserts should be of the smallest hole diameter possible still allowing the probe to slide in and out easily. Various insert sizes are available. Contact an Authorized Service Center for assistance (see Section 1.6 Authorized Service Centers on page 9). The well must be clear of any foreign objects, dirt and grit before an insert is installed. The insert is installed with the two small tong holes positioned upward.

Turn on the power to the calibrator by toggling the switch on the power entry module. After a brief self-test, the controller should begin normal operation. The main screen appears within 30 seconds. If the instrument fails to operate, please check the power connection. The display shows the well temperature, and waits for user input before further operation.

Press “SET PT.” and use the arrow keys to set the desired set-point temperature. Press “ENTER” to save the desired set-point and enable the instrument. After five (5) seconds, the instrument should start to operate normally and heat or cool to the designated set-point.

914X Field Metrology Wells

Parts and Controls



Figure 2 914X Field Metrology Well

3.2 Parts and Controls

This section describes the exterior features of the Field Metrology Well. All interface and power connections are found on the front of the instrument (see Figure 2).

3.2.1 Display Panel

Figure 3 on next page shows the layout of the display panel.

Display (1)

The display is a 240 x 160 pixel monochrome graphics LCD device with a bright LED back-light. The display is used to show current control temperature, measurements, status information, operating parameters, and soft key functions.

▲▼◀▶ Arrow Keys (2)

The Arrow Keys allow you to move the cursor on the display, change the display layout, and adjust the contrast of the display. The contrast can only be adjusted using the ▲ and ▼ arrow keys while viewing the main display window.

Enter Key (3)

The Enter Key allows you to select menus and accept new values.

SET PT. (4)

The Set Pt. Key allows you to enable the instrument to heat or cool to a desired set-point. Until this key is enabled, the instrument will not heat or cool. It is in a “sleep” state for safety of the operator and instrument.

°C/°F Key (5)

The °C/°F Key allows you to change the displayed temperature units from °C to °F and vice versa.

Menu Key (6)

The Menu Key allows the user to access all parameter and settings menus. From the main menu, the user can use the soft keys to access submenus and functions.

Exit Key (7)

The Exit Key allows you to exit menus and cancel newly entered values.

Soft Keys (8)

The Soft Keys are the four buttons immediately below the display (labeled F1 to F4). The functions of the soft keys are indicated on the display above the buttons. The function of the keys may change depending on the menu or function that is selected.

Switch Connector (9)

The switch hold connector posts are located on the left side of the display panel.

Block Temperature Indicator (10) [Patent Pending]

The Block Temperature Indicator lamp allows users to know when the block temperature is safe (50°C to 60°C) to remove inserts or move the Field Metrology Well. The indicator light is lit continuously once the block has exceeded approximately 50°C (varies 50°C to 60°C). The indicator light stays lit until the block cools to less than approximately 50°C. If the instrument is disconnected from mains power, the indicator light flashes until the block temperature is less than approximately 50°C.



Figure 3 Display panel and keys

3.2.2 Display

The front panel display is shown in detail in Figure 4 on opposite page.

Heat Source Temperature (1)

The most recent block temperature measurement is shown in large digits at the top of the screen.

Set-point Temperature (2)

The current set-point temperature is displayed just below the Heat Source Temperature.

Reference Temperature (3) [-P models only]

When installed, the most recent reference measurement is shown on the screen.

Stability Status (4)

On the right hand side of the screen, you will find a graph displaying the current status of the stability of the Field Metrology Well.

Heating/Cooling Status (5)

Just below the stability graph there is a bar graph that will indicate HEATING, COOLING, or CUTOUT. This status graph indicates the current level of heating or cooling if the instrument is not in cutout mode.

UUT Output (6) [-P models only]

When installed, the most recent UUT output measurement is shown. The value displayed depends on the output type selected: mA, RTD, or TC.

Soft Key Functions (7)

The four texts at the bottom of the display (not shown) indicate the functions of the soft keys (F1–F4). These functions change with each menu.

Editing Windows

While setting up and operating the instrument, you are often required to enter or select parameters. Editing windows appear on the screen when necessary to show the values of parameters and allow edits.

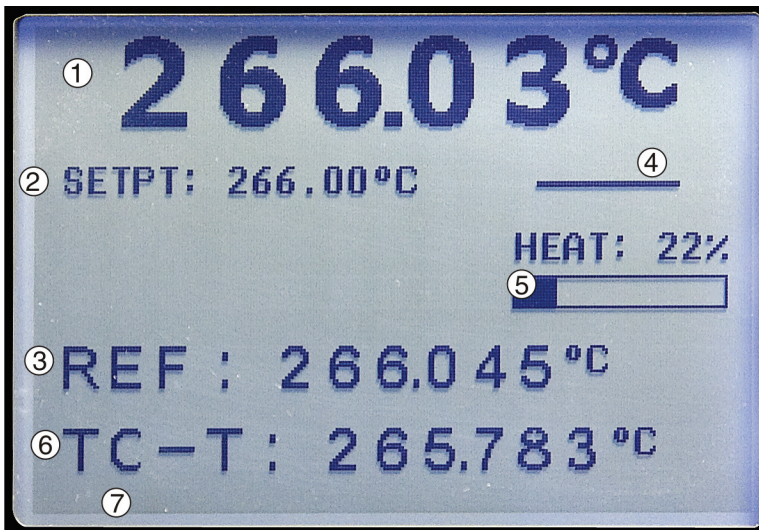

Figure 4 914X display

3.2.3 Power Panel

The following are found on the lower front panel of the instrument (see Figures 5 and Figure 6 on opposite page).

Power Cord Plug (1)

The power supply cord attaches to the lower front power panel. Plug the cord into an AC mains supply appropriate for the voltage range as specified in the specifications tables.

Power Switch (2)

For the 9142, the power switch is located on the power entry module of the unit at the lower center of the power panel.

For the 9143 and 9144, the power switch is located between the RS-232 and the fuses.

Serial Connector (3)

On the 9142, the serial connector is a 9-pin subminiature D type located on the power panel above the power entry module. On the 9143 and 9144, the serial connector is a 9-pin subminiature D type located on the power panel to the left of the power switch. The serial (RS-232) interface can be used to transmit measurements and control the operation of the instrument.

Fuses (4)

For the 9142, the fuses are located inside the power entry module of the unit (Figure 5 on opposite page).

For the 9143 and 9144, the fuses are separate from the power connector (Figure 6 on opposite page).

If necessary, fuses must be replaced according to Specifications (see Section 2.1 Specifications on page 11).

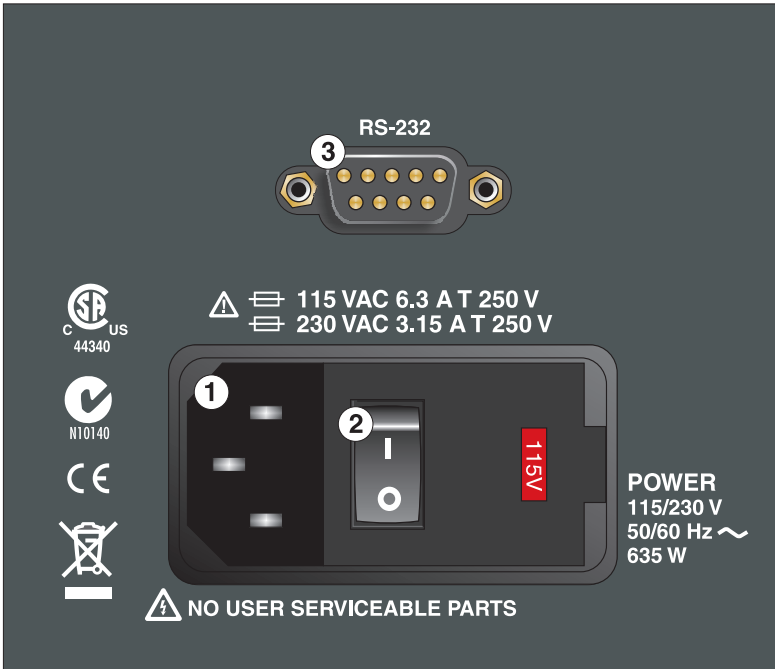

Figure 5 9142 power panel

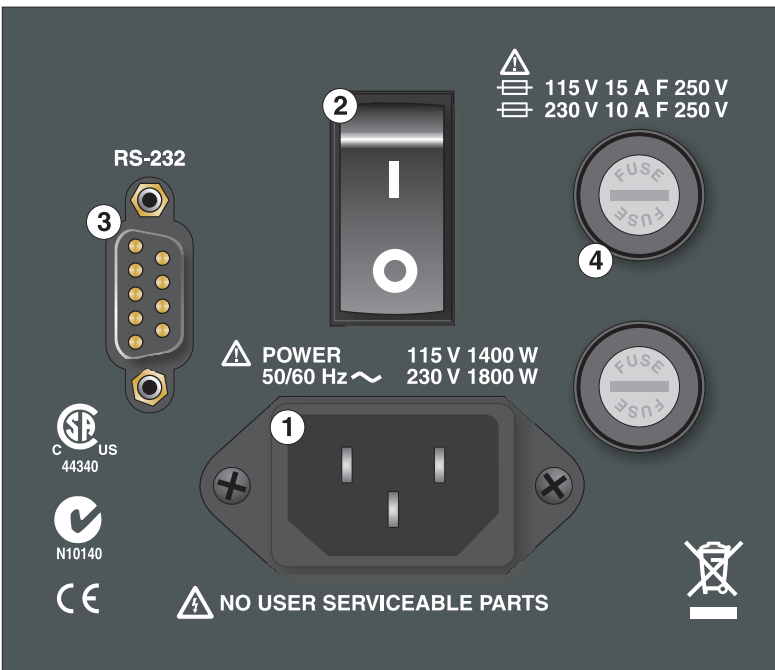

Figure 6 9143 and 9144 power panel

3.2.4 -P Option Panel (-P models only)

The -P (process version) panel is the readout portion of the instrument and is only available with -P models.

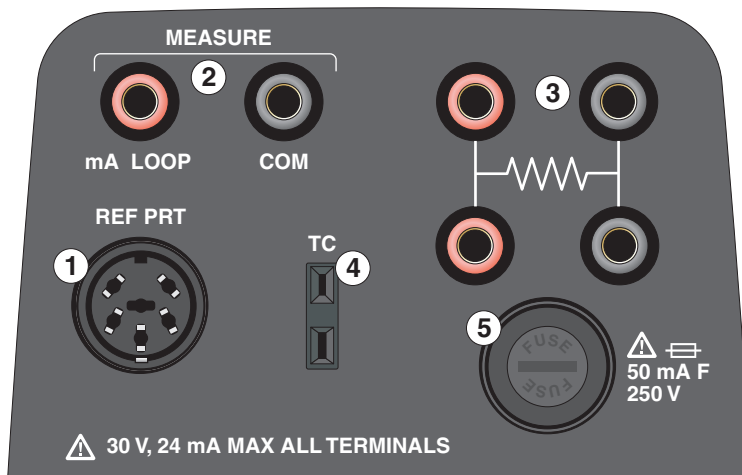

Figure 7 -P option panel

Reference Thermometer Connection (1)

The 6-pin DIN smart connector on the front panel allows a reference probe to be attached to the instrument for use with the reference thermometer function of the instrument. The smart connector stores probe calibration coefficients. The 6-pin DIN accepts traditional connectors and the probe coefficients can be entered into the readout or an appropriate characterization curve can be selected through the user interface (see Section 1.5.2 Immunity Testing on page 8 for information on using clamp-on ferrites).

A PRT is the only type of probe that is supported by the reference thermometer input. The PRT (RTD or SPRT) probe connects to the reference thermometer input using a 6-pin DIN connector. Figure 8 shows how a four-wire probe is wired to the 6-pin DIN connector. One pair of wires attaches to pins 1 and 2 and the other pair attaches to pins 4 and 5 (pins 1 and 5 source current and pins 2 and 4 sense the potential). If a shield wire is present, it should be connected to pin 3, which is also used for the memory circuit. Pin 6 is only used for the memory circuit.

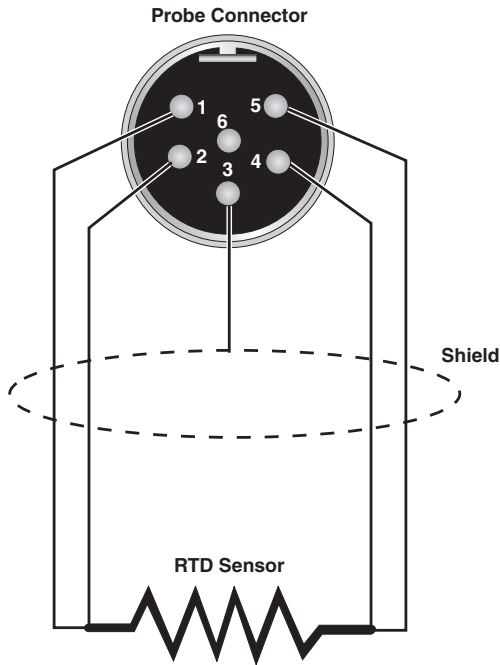

Figure 8 Probe connector wiring

A two-wire probe can also be used with the reference thermometer. It is connected by attaching one wire to both pins 1 and 2 of the plug and the other wire to both pins 4 and 5. If a shield wire is present, it should be connected to pin 3. Accuracy may be significantly degraded using a two-wire connection because of lead resistance.

4-20mA Connectors (2)

The 4-20mA connectors allow current and/or voltage probes to be connected for measurement of associated devices.

PRT/RTD Connector (3)

The 4-wire PRT/RTD connectors allow the user to connect 3-wire and 2-wire (with jumpers, see Figure 9 on next page) PRT/RTDs to the readout. The correct wiring for the 4-wire PRT/RTD is shown on the instrument. Figure 9 shows the correct wiring for a 2 or 3-wire PRT/RTD (see Section 1.5.2 Immunity Testing on page 8 for information on using clamp-on ferrites).

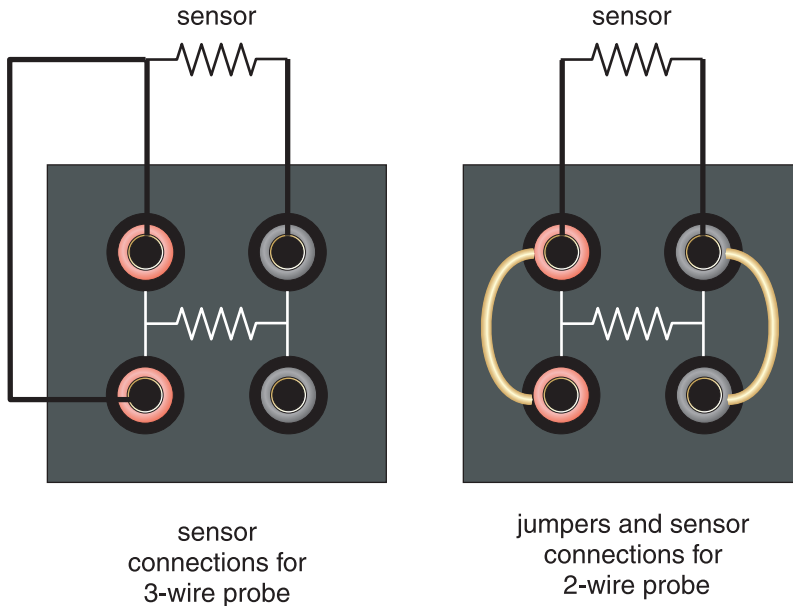

Figure 9 Jumper locations for 3-wire and 2-wire connections

Thermocouple (TC) Connector (4)

The TC connector allows for the use of subminiature TC connectors (see CE Comments on page 8 for information on using clamp-on ferrites).

Fuse (5)

Fuse for the 4-20 mA circuit. Always replace with a fuse of the appropriate rating (see Section 2.1 Specifications on page 11).

3.3 Languages

The display on Field Metrology Wells can be set to different languages depending on the configuration.

- European: English, French, Spanish, Italian, German
- Russian: Russian, English
- Asian: English, Chinese, Japanese

3.3.1 Language Selection

Select the language to be displayed by following the steps shown in Figure 10 on opposite page.

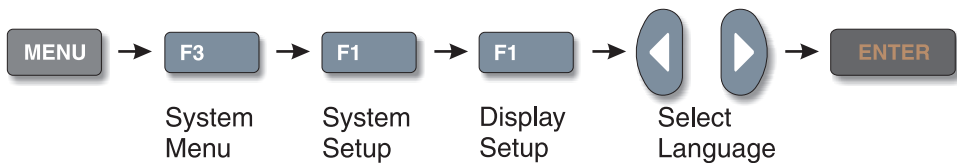

Figure 10 Steps to language selection

3.3.2 Reset to English Language

If you are in a language and need a short cut exit, press F1 and F4 simultaneously to reset the display to English.

To reset to your originally selected language after resetting to English, follow the steps in Figure 10 on this page.



Note: The F1 and F4 English shortcut override is temporary. If you toggle the power off, the instrument will return to the language selected in the DISPLAY SETUP menu rather than coming up in English.

4 Menu Structure

4.1 Temp Setup Menu

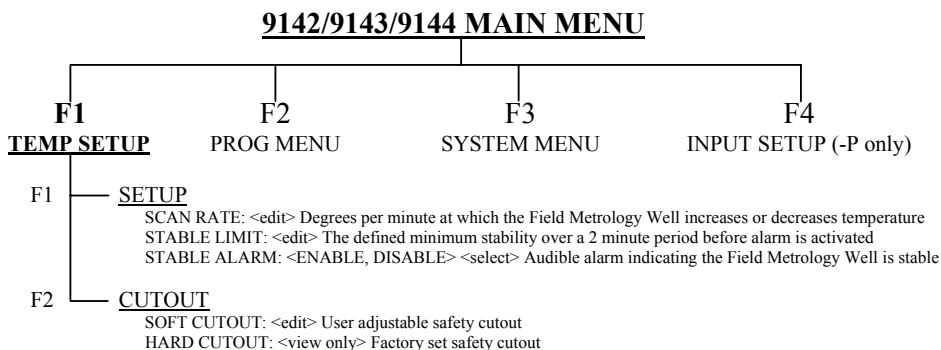

Hot Keys (while viewing main screen)

SETPoinT. Key - **SETPOINT**
 SETPOINT: <edit> Set point temperature
 ENTER <enable control of the instrument>
 F1 – SELECT PRESET <1-8> <select>
 F1 – EDIT PRESET <1-8> <edit>
 F4 – SAVE/DISABLE <disables control of instrument>

°C / °F Key - Units: <°C, °F> Changes temperature units

Up/Down Arrow Keys <toggle> <adjust contrast>
 Up Key: Darker
 Down Key: Lighter

F1 & F4 Keys (same time) <reset display language to English>

F1 & F3 Keys (same time) <enable/disable key press beep>
 1 Beep – Valid key entry
 2 Beep – Invalid key entry

Code Update Mode Keys

ENTER & EXIT Keys (hold during power up) <initiate code update mode> Allows instrument software to be updated

Figure 11 Main Menu - Temp SetUp

4.2 Prog Menu

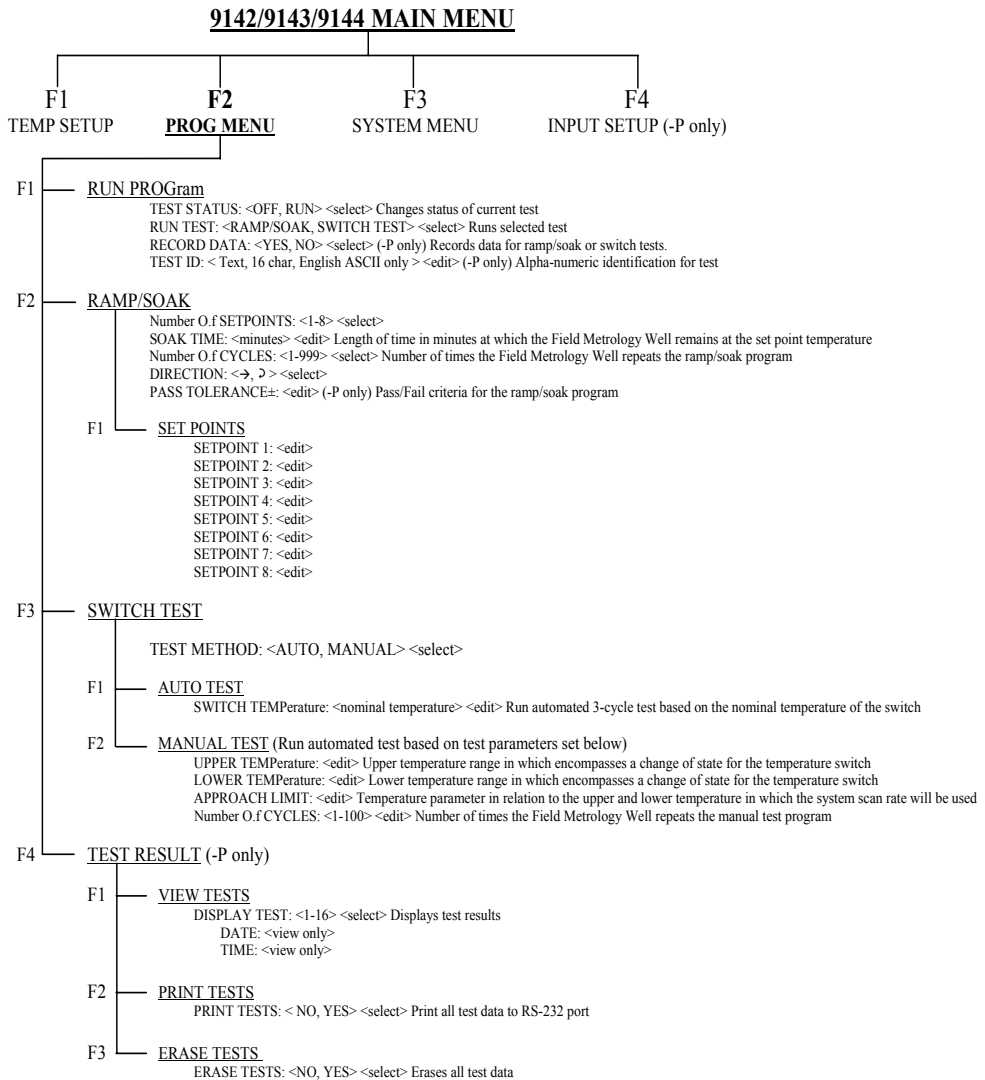

Figure 12 Main Menu - Prog Menu

4.2.1 Switch Test Parameters

SWITCH TEMP

The SWITCH TEMP parameter is the nominal change temperature of the switch.

UPPER TEMP

The UPPER TEMP parameter is the temperature during a cycle at which the Field Metrology Well begins to heat or cool at the rate specified in “Scan Rate” found in MAIN MENU|TEMP SETUP|SETUP|SCAN RATE.

LOWER TEMP

The LOWER TEMP parameter is the temperature at which the Field Metrology Well heats or cools, in order to begin testing if the test is just starting or the temperature at which the instrument begins to heat to start a cycle.

APPROACH

The APPROACH parameter controls the use of the Scan Rate during the approach to the set-point. During the test, the controller uses the system Scan Rate until the temperature is within the approach temperature of either the high temp or low temp parameters.

NO. CYCLES

The NO. CYCLES parameter determines how many times the instrument heats and cools allowing a thermal switch or batch of switches to be tested.

4.2.2 Switch Test Description



CAUTION: *The switch, switch wires, switch components and switch accessories can be damaged if the Field Metrology Well exceeds their temperature limits.*

The SWITCH TEST is used to select, set up, execute and view the results of switch tests. The Switch Test function allows thermal switches to be tested for open and/or close temperatures. The Switch Test allows for Auto or Manual operation. Figure 13 on next page shows a graphical representation of how a switch test works.

For Auto operation, enter the Prog Menu. Under Switch Test, select Auto Test. Enter the SWITCH TEMP. Set the Test Method to AUTO. Exit to the Run Prog menu. Ensure that Run Test is set to SWITCH TEST. Set Test Status to RUN. Press Enter and the instrument will engage and start the 3-cycle test within a few seconds. Exit to the main screen to view the test progress, refer to the Menu Structure.

For Manual operation, in the Temp Setup menu, select Setup and enter the SCAN RATE. Exit to the Prog Menu. Under Switch Test, select Manual Test. Enter the UPPER TEMP, LOWER TEMP, APPROACH LIMIT, and NO. CYCLES parameters. Set the Test Method to MANUAL. Exit to the Run Prog menu. Ensure that the Run Test is set to SWITCH TEST. Set Test Status to

RUN. Press Enter and the instrument will engage and start the test within a few seconds. Exit to the main screen to view the test progress, refer to the Menu Structure.

When the switch resets, the test completes and the values of the switch OPEN, switch CLOSE, and switch BAND are displayed for the user to record. The values may also be recorded internally in the instrument by selecting the option to record the data (-P model only).

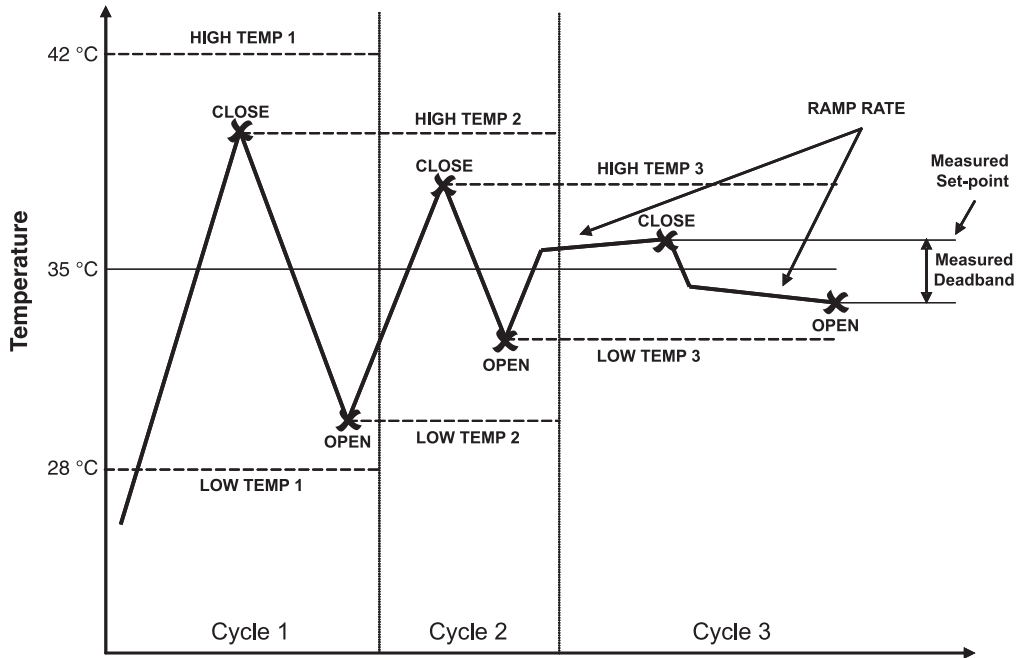

Figure 13 Auto and manual switch test operation example

4.3 System Menu

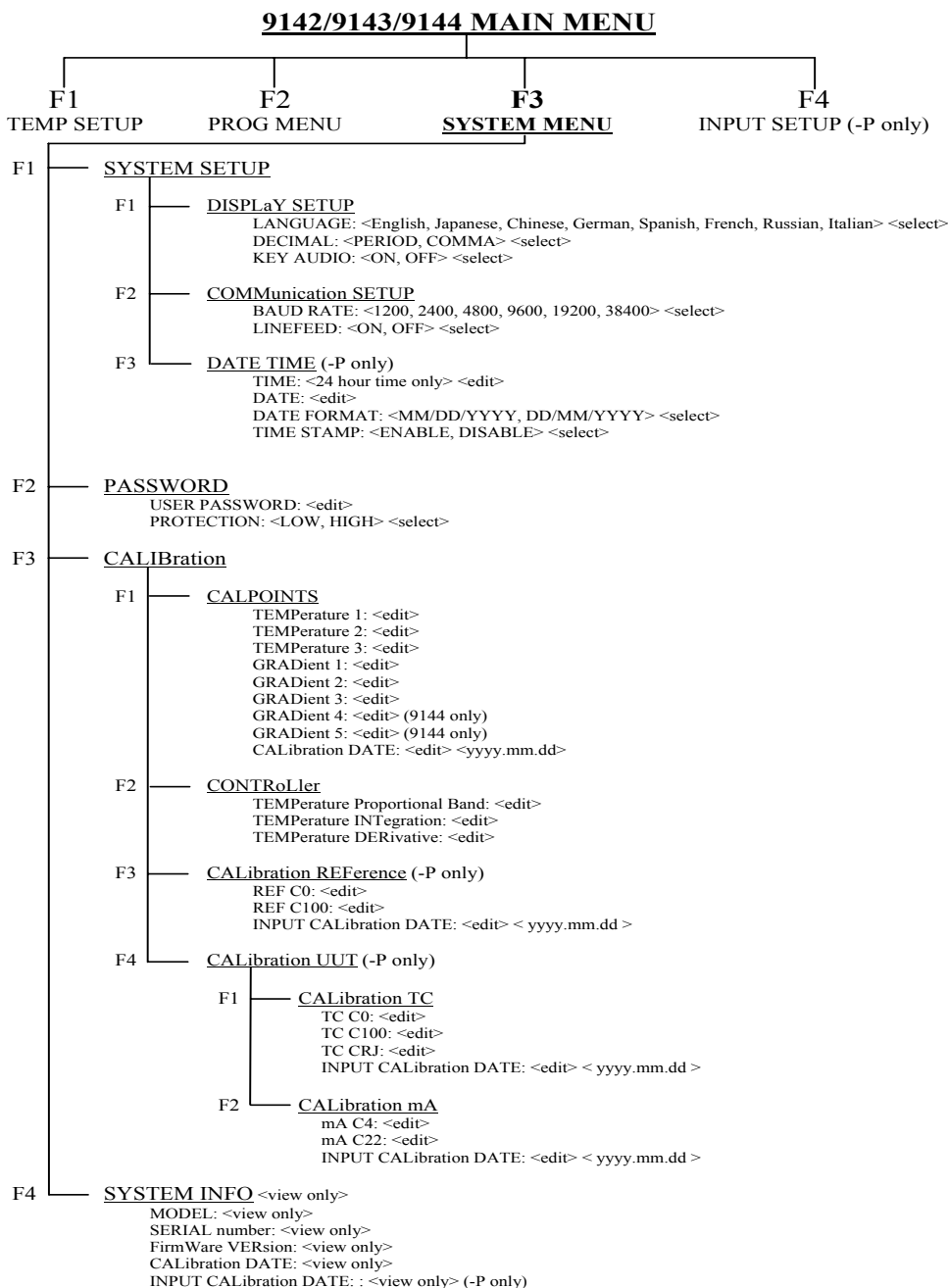

Figure 14 Main Menu - System Menu

4.4 Input Setup (-P only)

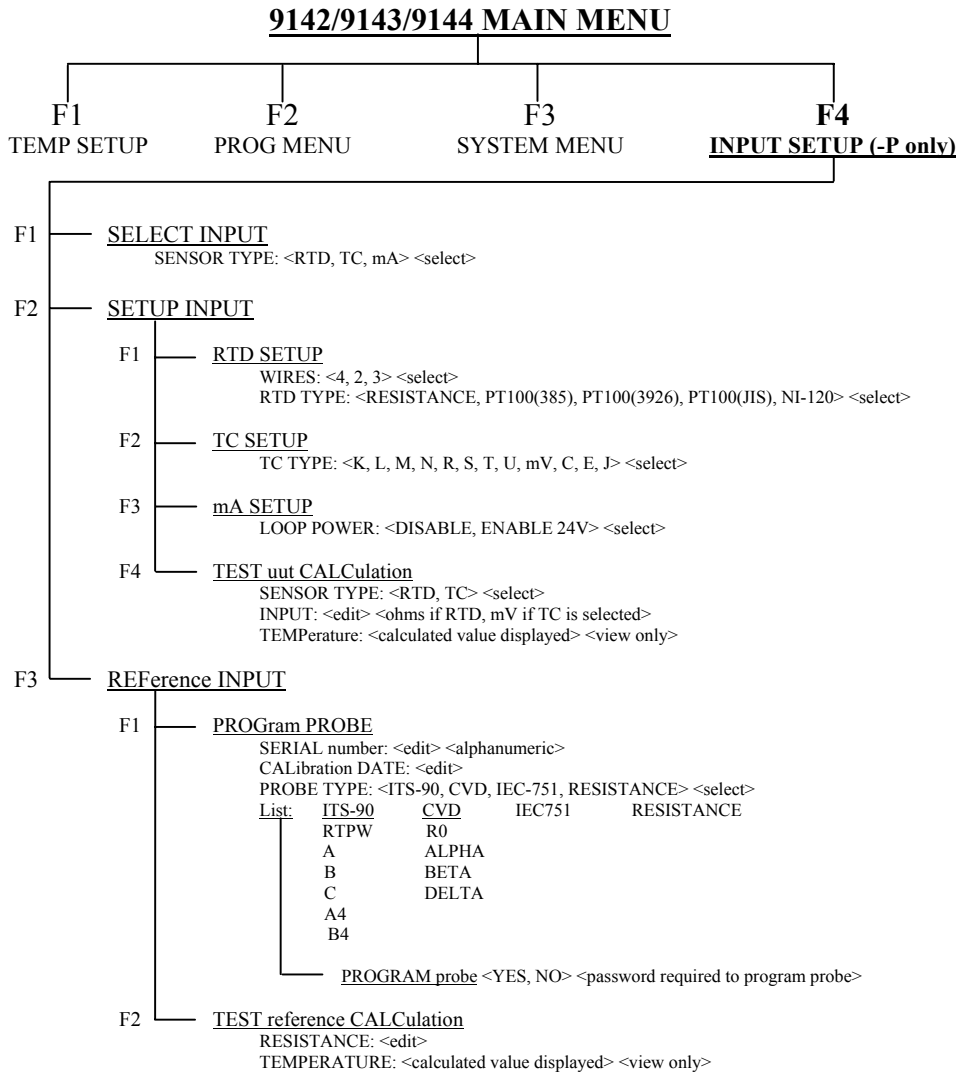

Figure 15 Main Menu - Input Setup

5 Controller operation

This chapter discusses in detail how to operate the Field Metrology Well temperature controller and/or thermometer readout using the front control panel. Using the front panel keys and liquid crystal display (LCD) the user may monitor the well temperature, set the temperature set-point in °C or °F, monitor the heater output power, monitor the stability, set the cutout set-point, set the operating parameters, and configure the communication interface. For the -P model, the user has full control of thermometer readout functions of the instrument using the front panel keys and the LCD. A diagram of the full menu structure can be found in Section 4 Menu Structure on page 27. When active, menu keys are selected using the soft keys (F1-F4).

5.1 Main Screen

The LCD on the front panel allows direct viewing of the control temperature (actual well temperature), reference thermometer temperature (-P model only), heating or cooling power, stability state, current set-point information, current secondary readout input (-P model only) (PRT/RTD, TC, mA) and current program information. The temperature displayed is either in °C or °F. The displayed temperature units can easily be changed by pressing the C/F key on the front panel.

HEAT SOURCE TEMPERATURE

This is the temperature of the block as measured by the control sensor. The controller heats or cools the block to force the control temperature equal to the set-point.

SET-POINT (SETPT)

This is the current set-point.

REFERENCE TEMPERATURE (REF) (-P model only)

This is the temperature measured by an external reference thermometer attached to the Reference Thermometer 6-pin DIN Info-Con input.

CONTROL - STAB (Stability)

This shows the stability of the block. When the stability is within the set limit this line is flat.

CONTROL - HEAT/COOL

This shows the relative heating or cooling power (duty cycle) in percent.

HEATING, COOLING, CUTOUT

This shows the status of heating or cooling or the cutout when activated. The bar graph indicates the relative heating or cooling power.

SECONDARY READOUT INPUT (-P model only)

This indicates the type of input selected for the UUT Input, PRT/RDT, TC, mA. Additionally, the appropriate reading measured by the attached probe is indicated.

5.2 Main Menu

The MAIN MENU is accessed through the MENU button and allows access to all main sub-menus. The submenus allow the user to setup the instrument as desired and to change system parameters as needed.

5.2.1 Temp Setup

The TEMP SETUP menu contains Field Metrology Well functions related to temperature setup.

5.2.1.1 Setup

5.2.1.1.1 SCAN RATE

The SCAN RATE parameter can be set such that when the set-point is changed, the Field Metrology Well heats or cools at a specified rate, degrees per minute, ($^{\circ}\text{C}/\text{min}$ or $^{\circ}\text{F}/\text{min}$) until it reaches the new set-point.

The Scan Rate can be set from 0.1 to 500 $^{\circ}\text{C}/\text{min}$ (0.2 to 932 $^{\circ}\text{F}/\text{min}$). However, the maximum scan rate is limited by the natural heating or cooling rate of the instrument, which will be less than the maximum setting, especially when cooling.

The Scan Rate can be adjusted using the arrow keys. Once the scan rate has been set, press “ENTER” to set the new scan rate.

5.2.1.1.2 STABLE LIMIT



NOTE: *The Field Metrology Well should not be expected to operate better than the stability specification set forth in the Specifications section of this guide. Therefore, the minimum setting of the stability limit should not be less than the stability specification.*

The STABLE LIMIT parameter allows the instrument to notify the user when it has achieved the stability limit set in this parameter. There are two notifications: visual and audible. The visual notification is always active. When the instrument is operating within the stability limit, the stability graph on the main screen remains flat once the instrument is within the given specification, otherwise the graph indicates the instrument is not yet stable. The audible, if enabled, alerts the user once per set-point when the instrument achieves the set stability limit. Use the arrow keys to set the desired stability limit and press “ENTER” to accept the new stability limit.

Example:

A specific calibration process requires the instrument to operate within $\pm 0.1^{\circ}\text{C}$. “0.1” would be entered into the stability limit parameter. When the instrument’s stability is within $\pm 0.1^{\circ}\text{C}$, the graph is flat and the audible alarm (if enabled) notifies the user that the instrument is operating

within $\pm 0.1^{\circ}\text{C}$. Use the arrow keys to set the desired stability limit and press “ENTER” to accept the new stability limit.

5.2.1.1.3 STABLE ALARM

The audible alarm described in STABLE LIMIT is turned on or off using the STABLE ALARM parameter. Select the either “Enable” or “Disable” using the left or right arrow keys and press “ENTER” to accept the selection.

5.2.1.2 CUTOUT

The view CUTOUT contains the Cutout functions of the instrument.

5.2.1.2.1 SOFT CUTOUT

The SOFT CUTOUT is user settable. As a protection against software or hardware fault or user error, the calibrator is equipped with the adjustable cutout device that shuts off power to the heat source if the well temperature exceeds a set value. It is factory set as a default ten degrees above the high limit of the instrument. The user should set the Soft Cutout according to the temperature limits of the probes being calibrated. The Soft Cutout can act as a safety barrier to protect probes from being over heated to temperatures beyond their specified temperature limits if the Soft Cutout is set appropriately for probes under test. This feature protects the instrument and probes from excessive temperatures.

If the cutout is activated because of excessive well temperature, power to the heat source shuts off and the instrument cools. The heat source remains in cutout mode and active heating and cooling is disabled until the user manually resets the cutout. If the over-temperature cutout has been triggered, the instrument displays “CUTOUT” above the duty cycle bar graph, which indicates a cutout condition. The instrument remains in cutout mode until the temperature is reduced and the cutout is reset. The well temperature must drop a few degrees below the cutout set-point before the cutout can be reset.

For safety reasons, the cutout only has one mode — manual reset. Manual reset mode means the cutout must be reset by the operator after the temperature falls below the set-point.

The SOFT CUTOUT parameter can be set to any temperature over the range of the instrument. The cutout should be set within $5\text{-}10^{\circ}$ of the safety limit of the equipment being calibrated or used with the Field Metrology Well.



NOTE: *CUTOUT RESET: If the Field Metrology Well exceeds the temperature set in the soft cutout menu or if it exceeds the maximum operating temperature of the instrument, a cutout condition occurs. If this happens, the instrument enters cutout mode and will not actively heat or cool until the user resets the instrument.*

To reset the cutout, the instrument temperature must cool to lower than the cutout set-point. Once the instrument has cooled the user may reset the instrument by pressing “SET PT.” and pressing “ENTER” to engage instrument.

5.2.1.2.2 HARD CUTOUT

The HARD CUTOUT parameter is a view only function and indicates the factory setting for the hard cutout. The Hard Cutout is not user settable.

5.2.2 Prog Menu

The PROG MENU (PROGRAM MENU) allows access to the automated and manual program selections. These include the Ramp and Soak program and the Switch Test.

5.2.2.1 RUN PROG

The RUN PROG (RUN PROGRAM) allows the user to access program status features.

5.2.2.1.1 TEST STATUS

The TEST STATUS option controls the state of the program. The user selects to Run the program or to turn the program Off.

5.2.2.1.2 RUN TEST

The RUN TEST option allows the user to select the test to run, Ramp and Soak or Switch Test.

5.2.2.1.3 RECORD DATA

The RECORD DATA option allows the user to select to record the data from the test (Yes) or not to record data (No).

5.2.2.1.4 TEST ID

The TEST ID (Identification) allows the user to enter a Test ID number for the current test. The Test ID can be an alpha numeric entry up to 16 characters in length.

5.2.2.2 RAMP/SOAK

The RAMP/SOAK feature automatically cycles the Field Metrology Well between temperatures while holding at each temperature for the length of time set by the user.

5.2.2.2.1 NO. SETPOINTS

The NO. SETPOINTS is the number of set-points defined for a given program. The number of set-points for each program can be set from 1 to 8 and vary depending on the needs of the user. Set the maximum number of set-points needed for the program selected. Once the number of set-points is selected, press "ENTER" to accept the new setting.

5.2.2.2.2 SOAK TIME

The SOAK TIME parameter is the number of minutes that each of the program set-points is maintained. The time starts when the temperature settles to within the specified stability. The stability limit is set in the TEMP SETUP|SETUP|STABLE LIMIT window.

5.2.2.2.3 NO. CYCLES

The NO. CYCLES parameter is the number of times that the program is repeated.

5.2.2.2.4 DIRECTION

The DIRECTION parameter controls whether the set-points are sequenced in one direction, 1-8, or both directions, 1-8 and 8-1, before the sequence is repeated. If the both directions option is selected, the program sequences from the first set-point to the last and then reverses direction sequencing from the last to the first.

5.2.2.2.5 PASS TOLERANCE

The PASS TOLERANCE is the allowable tolerance condition for the test and is used to highlight test points that have large errors.

5.2.2.2.6 SETPOINTS

The SETPOINTS menu allows the user to set each of the set-points for the program. Only the number of set-points defined by NO SETPOINTS will be displayed. Set-points can be quickly selected using the Up/Down arrow keys to scroll through the set-points. Press “Enter” to activate the set-point and make it editable. Once editable, use the Up/Down arrow keys to enter the values and the Left/Right arrow keys to scroll through the digits in the value. Press “Enter” to accept the value entered.

5.2.2.2.6.1 SETPOINT 1 – SETPOINT 8 (Depending on NO. SETPOINTS defined)

The SETPOINT n parameter is the designated temperatures for the set-points selected for the program.

5.2.2.3 SWITCH TEST

The SWITCH TEST is used to select, set up, execute and view the results of switch tests. The Switch Test function allows thermal switches to be tested for open and/or close temperatures. The Switch Test allows for Auto or Manual operation. Operation of the switch test feature is outlined below.



CAUTION: *The switch, switch wires, switch components and/or switch accessories can be damaged if the Field Metrology Well exceeds its temperature limits.*

5.2.2.3.1 TEST METHOD

The TEST METHOD is used to select AUTO or MANUAL test configuration.

5.2.2.3.2 AUTO TEST

The AUTO TEST is used to set up the parameter for the Auto Test.

5.2.2.3.2.1 SWITCH TEMP

The SWITCH TEMP parameter is the nominal change temperature of the switch.

5.2.2.3.3 MANUAL TEST

The MANUAL TEST is used to set up the parameters for the Manual Test.

5.2.2.3.3.1 UPPER TEMP

The UPPER TEMP parameter is the temperature during a cycle at which the Field Metrology Well begins to heat or cool at the rate specified in “Scan Rate” found in MAIN MENU|TEMP SETUP|SETUP|SCAN RATE.

5.2.2.3.3.2 LOWER TEMP

The LOWER TEMP parameter is the temperature at which the Field Metrology Well heats or cools, in order to begin testing if the test is just starting or the temperature at which the instrument begins to heat to start a cycle.

5.2.2.3.3.3 APPROACH LIMIT

The APPROACH parameter controls the use of the Scan Rate during the approach to the set-point. During the test, the controller uses the system Scan Rate until the temperature is within the approach temperature of either the high temp or low temp parameters.

5.2.2.3.3.4 NO. CYCLES

The NO. CYCLES parameter determines how many times the instrument heats and cools allowing a thermal switch or batch of switches to be tested.

Basic switch operation

A temperature switch is a device that senses temperature and activates a contact closure based upon the temperature value. The temperature at which the switch activates is called the set-point and is an important value that needs to be verified during testing. Another critical value, which is called the deadband, determines when the output is active or inactive around the set-point value (see Figure 16 on opposite page). Testing and determining the deadband value is imperative to proper and safe operation.

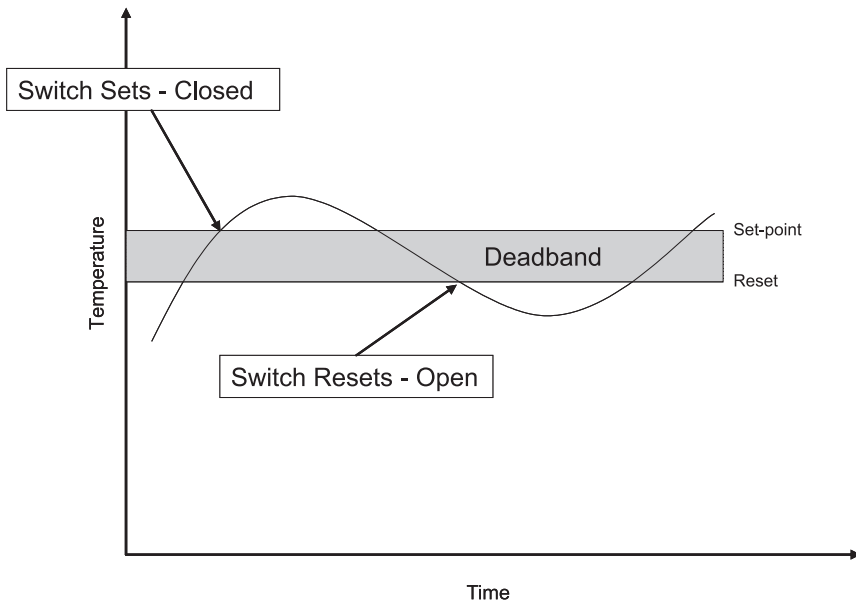

Figure 16 Schematic diagram showing the deadband in a temperature switch as it closes and opens with temperature changes.

Auto switch test operation

First, connect the thermostatic switch to the terminals located on the front of the Field Metrology Well (see Figure 3 on page 18) and insert the switch into the thermal well.

For Auto operation enter the Prog Menu. Under Switch Test, select Auto Test. Enter the SWITCH TEMP. Set the Test Method to AUTO. Exit to the Run Prog menu. Ensure that Run Test is set to SWITCH TEST. Set Test Status to RUN. Press Enter. EXIT the RUN PROG menu and the instrument will engage and start the 4-cycle test within a few seconds. Exit to the main screen to view the test progress. When the switch resets, the test completes and the values of the switch OPEN, switch CLOSE, and switch BAND are displayed for the user to record. The values may also be recorded internally in the instrument by selecting the option to record the data (-P model only) (Refer to the Menu Structure.)

To stop a Switch Test in progress, press MENU|PROG MENU|RUN PROG|TEST STATUS. Change the TEST STATUS to OFF and press ENTER EXIT the RUN PROG menu to abort the test.

Manual switch test operation

For Manual operation in the Temp Setup menu select Setup enter the SCAN RATE. Exit to the Prog Menu. Under Switch Test, select Manual Test. Enter the UPPER TEMP, LOWER TEMP, APPROACH LIMIT, AND NO. CYCLES parameters. Set the Test Method to MANUAL. Exit to the Run Prog menu. Ensure that the Run Test is set to SWITCH TEST. Set Test Status to RUN. Press Enter. EXIT the RUN PROG menu and the instrument will engage and start the test within a few seconds. Exit to the main screen to view the test progress. The values may also be

recorded internally in the instrument by selecting the option to record the data (-P model only) (Refer to the Menu Structure, see Figure 12 on page 28 and Figure 13 on page 30.)

To stop a Switch Test in progress, press MENU|PROG MENU|RUN PROG|TEST STATUS. Change the TEST STATUS to OFF and press ENTER EXIT the RUN PROG menu to abort the test.

Manual Switch Test Example

First, connect the thermostatic switch to the terminals located on the front of the Field Metrology Well (see Figure 3 on page 18) and insert the switch into the thermal well.

The temperature switch in the following example has a set-point of 35°C. Above this temperature, the output contacts are closed, turning the heat exchanger on. The deadband needs to be at least 1°C but no more than 3°C. Below are the parameters that are programmed into the Field Metrology Well for this example:

SCAN RATE: 1.0°C/min

LOWER TEMP: 28°C

UPPER TEMP: 42°C

APPROACH LIMIT: 3°C

RAMP RATE: 0.25°C

NO. CYCLES: 3

The low and upper temp values are chosen to provide a window around the actual expected set-point. Some switches may require a wider window. The chosen window gives the instrument an approximation of where the switch will open and close.



NOTE: *If the window is too narrow, the switch test may abort before determining the characteristics of the switch.*

Figure 13 on page 30, auto manual switch test, shows a diagram of how this test might progress. The Field Metrology Well will set its set-point temperature to the UPPER TEMP parameter in the setup above and heat the well at the system scan rate until the switch activates and closes. The Field Metrology Well will then change its set-point to the LOWER TEMP parameter and cool using the system scan rate until the switch resets and opens. This is the end of the first cycle. For the second cycle, the Field Metrology Well will change its set point to the switch activation temperature measured in cycle one, and start to heat. When the switch activates, the Field Metrology Well will change its set-point to the switch reset temperature measured in the first cycle and start cooling. In the example, as the Field Metrology Well heats in the third cycle, it reaches the approach temperature (UPPER TEMP 3 minus APPROACH parameter) and the instrument changes its scan rate by decreasing the system scan rate to 25%. When the switch activates, the instrument sets its set-point to the reset temperature measured in the second cycle, and the instrument starts to cool. When the switch resets, the test completes and the values of the switch OPEN, switch CLOSE, and switch BAND are displayed for the user to record.



NOTE: $10^{\circ}\text{C}/\text{min}$ is the recommended maximum for the SCAN RATE during SWITCH TEST operation.



NOTE: The APPROACH LIMIT AND CYCLES should be set such that the highest desired accuracy of the switch temperatures is obtained.



NOTE: Depending on the mass and/or diameter of the switch, there may be a significant lag time in how fast the switch heats up or cools with respect to the block of the Field Metrology Well. For larger mass and/or diameter switches, a lower SCAN RATE ($0.4\text{--}1.0^{\circ}\text{C}$) and a higher APPROACH ($5\text{--}10^{\circ}\text{C}$) can produce better results. More cycles may give a better average of when the switch opens and closes, but a minimum of 2 cycles should be used when running a switch test.

See Figure 13 on page 30.

When the switch resets, the test completes and the values of the switch OPEN, switch CLOSE, and switch BAND are displayed for the user to record. The values may also be recorded internally in the instrument by selecting the option to record the data (-P model only)

5.2.2.4 TEST RESULTS

The TEST RESULTS MENU allows the user access to the tests parameters.

5.2.2.4.1 VIEW TESTS

The VIEW TESTS menu allows the user to view the results of up to 16 tests.

5.2.2.4.1.1 TEST ID

The TEST ID (TEST IDENTIFICATION) parameter allows the user to select from 16 tests to view.

5.2.2.4.1.2 TYPE

The TYPE parameter allows the user to select between viewing Ramp & Soak and Switch Test results.

5.2.2.4.1.3 DATE (VIEW ONLY)

The DATE the selected test was performed.

5.2.2.4.1.4 TIME (VIEW ONLY)

The TIME the selected test was performed.

5.2.2.4.1.5 RESULTS (press ENTER)

The RESULTS menu is the second part of the VIEW TESTS menu and allows the user to view the results of the selected test.

5.2.2.4.1.5.1 SWITCH TEST

5.2.2.4.1.5.1.1 TEST ID

The TEST ID (TEST IDENTIFICATION) parameter allows the user to select from 16 tests to view.

5.2.2.4.1.5.1.2 OPEN

The OPEN result provides the switch open temperature.

5.2.2.4.1.5.1.3 CLOSE

The CLOSE result provides the switch close temperature.

5.2.2.4.1.5.1.4 BAND

The BAND result is the difference between the open and close temperatures.

5.2.2.4.1.5.2 RAMP & SOAK

5.2.2.4.1.5.2.1 TEST ID

The TEST ID (TEST IDENTIFICATION) parameter allows the user to select from 16 tests to view.

5.2.2.4.1.5.2.2 WELL

The WELL (WELL TEMPERATURE) result provides the temperature of the dry-well as measured by the control sensor.

5.2.2.4.1.5.2.3 REF

The REF (REFERENCE) result provides the temperature of the reference probe.

5.2.2.4.1.5.2.4 UUT

The UUT result provides the temperature of the UUT probe.

5.2.2.4.1.5.2.5 DIFF

The DIFF (DIFFERENCE) result provides the difference between the Reference and the UUT probe. If the difference is greater than the PASS TOLERANCE, the DIFF will be highlighted.

5.2.2.4.2 PRINT TESTS

The PRINT TESTS parameter allows the user to the option to print the selected test results. YES enables the print option. NO disables the print option.

5.2.2.4.3 ERASE TESTS

The ERASE TESTS option is unconditionally password protected. The user has the choice, YES/NO, to erase all of the stored tests. A warning is presented to the user stating that all tests will be erased.

5.2.3 System Menu

The System Menu allows the user to set up the display settings, communications protocol, date/time settings (-P model only), password settings, calibrations settings, and view system information.

5.2.3.1 SYSTEM SETUP

The SYSTEM SETUP menu contains the Display Setup, Communications Setup, and Date/Time Setup (-P model only).

5.2.3.1.1 DISPLY SETUP

The DISPLY SETUP (DISPLAY SETUP) parameter contains the language selection, decimal separator, and keypad sound parameters.

5.2.3.1.1.1 LANGUAGE

The LANGUAGE parameter is used to set the display language. Use the right or left arrow key to select the preferred language and press “ENTER” to accept the selection. The user needs to exit from the SYSTEM MENU window in order for the change in language selection to take affect.



NOTE: *If the wrong language is selected, return to the Main Screen by holding EXIT for a few seconds. Once the Main Screen is displayed, simultaneously press and hold F1 and F4 to set to English temporarily. Then return to the DISPLAY SETUP screen and set the correct language.*

5.2.3.1.1.2 DECIMAL

The DECIMAL parameter is used to determine the decimal separator, a comma or a period. Select the desired decimal separator using the right or left arrow key and press “ENTER” to accept the selection.

5.2.3.1.1.3 KEY AUDIO

The KEY AUDIO parameter (F1 and F3 Keys pressed simultaneously) enables or disables the key press beep.

5.2.3.1.2 COMM SETUP

The COMM SETUP (COMMUNICATIONS SETUP) menu contains the serial interface parameters. The parameters in the menu are—BAUD RATE and LINEFEED.

5.2.3.1.2.1 BAUD RATE

The BAUD RATE parameter determines the serial communication transmission rate or baud rate.

BAUD may be programmed to 1200, 2400, 4800, 9600, 19200, or 38400 baud.

5.2.3.1.2.2 LINEFEED

The LINEFEED enables (On) or disables (Off) transmission of a line feed character (LF, ASCII 10) after transmission of any carriage-return. The LINEFEED default setting is on. The line feed parameter can be turned on or off as needed by the user.

5.2.3.1.3 DATE TIME (-P model only)

The DATE TIME menu allows the user to set the format for the date and time. Additionally, the user sets the date and time for the date and time stamp function.

5.2.3.1.3.1 TIME

The TIME parameter allows the user to set the internal time for the instrument. The time is tracked using a 24-hour clock. To set the time, press “Enter” and use the arrow keys to set the time and press “Enter” to accept the selection.

5.2.3.1.3.2 DATE

The DATE parameter allows the user to enter the date for the date/time stamp function. Press “Enter” to access the parameter. Use the arrow keys to enter the date and press “Enter” to accept the selection.

5.2.3.1.3.3 REPORT DATES

The REPORT DATES parameter allows the user to select the date format. Use the left and right arrow keys to choose the date format, mm/dd/yyyy or dd/mm/yyyy, and press “Enter” to accept the selection.

5.2.3.2 PASSWORD

The PASSWORD (PASSWORD SETUP) menu is used to set the system password or set the level of protection that conditional engages or disengages protection of certain groups of parameters.

5.2.3.2.1 USER PASSWORD

The USER PASSWORD parameter allows the users to enter and change the system and conditional password used to access protected menus. The Password is a number between one and four digits. Each digit of the password can be a number from 0 to 9. The default System Password is “1234”. If desired, the System Password can be changed in this menu by using the numeric keys to enter the new password and pressing “ENTER”.

5.2.3.2.2 PROTECTION

The PROTECTION parameter is used to enable (HIGH) or disable (LOW) password protection for the conditional parameters. The password is the same as the system password. The user has to option to conditionally password protect the Soft Cutout, Ramp & Soak, and Probe Prog. The user selects to “HIGH” or “LOW” the conditional password using the left and right arrow keys and presses “Enter” to accept the selection.

5.2.3.3 CALIB



CAUTION: *Calibration parameters must be correct for the instrument to function properly.*

The CALIB (CALIBRATION) menu allows the user access to the calibration parameters for the instrument. Access to the heat source and readout calibration parameters is protected by a password. Calibration parameters are programmed at the factory when the instrument is calibrated. These parameters may be adjusted to improve the accuracy of the instrument by qualified personnel. Instructions for calibration can be found in the “Calibration of your Field Metrology Well” section of this guide.



CAUTION: *DO NOT change the values of the control parameters from the factory set values unless you are recalibrating the instrument. The correct setting of these parameters is important to the safe and proper operation of the calibrator.*

The parameters in the CALIB menu are set at the factory and must not be altered unless recalibrating the instrument. Recalibration of the instrument should be performed by trained, knowledgeable personnel. The correct values are important to the accuracy and proper and safe operation of the calibrator. Access to these parameters is protected by a password. In the event that the calibration parameters need to be reentered into the instrument, these constants and their settings are listed in the Report of Calibration shipped with the instrument.

5.2.3.3.1 CAL POINTS

The CAL POINTS (CALIBRATION POINTS SETUP) menu contains the heat source calibration constants, TEMP CALPT 1, TEMP CALPT 2, and TEMP CALTPT 3. Use the arrow keys to enter the set-point for each calibration point and press “Enter” to accept the entry. The calibration points should be selected applicable to model with a low, mid-range, and high set-point.

5.2.3.3.1.1 TEMP 1

The TEMP 1 parameter is the offset in °C for the heat source accuracy at the 1st calibration point.

5.2.3.3.1.2 TEMP 2

The TEMP 2 parameter is the offset in °C for the heat source accuracy at the 2nd calibration point.

5.2.3.3.1.3 TEMP 3

The TEMP 3 parameter is the offset in °C for the heat source accuracy at the 3rd calibration point.

5.2.3.3.1.4 GRAD 1

The GRAD 1 parameter is ratio for the top zone heater control for the axial gradient calibration at the 1st calibration point.

5.2.3.3.1.5 GRAD 2

The GRAD 2 parameter is ratio for the top zone heater control for the axial gradient calibration at the 2nd calibration point.

5.2.3.3.1.6 GRAD 3

The GRAD 3 parameter is ratio for the top zone heater control for the axial gradient calibration at the 3rd calibration point.

5.2.3.3.1.7 GRAD 4 (9144 only)

The GRAD 4 parameter is a ratio for the top zone heater control for the axial gradient calibration at the fourth calibration point.

5.2.3.3.1.8 GRAD 5 (9144 only)

The GRAD 5 parameter is a ratio for the top zone heater control for the axial gradient calibration at the fifth calibration point.

5.2.3.3.1.9 CALDATE

The CALDATE parameter is the calibration date for the heat source. Use the arrow keys to enter the calibration date in the format selected in DATE FORMAT.

5.2.3.3.2 CONTRL

The CONTRL (CONTROL SETUP) menu is used to access the controller parameters.

5.2.3.3.2.1 TEMP PB

The TEMP PB parameter is the main zone proportional band and the gain in °C that the instrument's proportional-integral-derivative (PID) controller uses for main zone control.

5.2.3.3.2.2 TEMP INT

The TEMP INT parameter is the main zone integral, which is the integration time in seconds that the instrument's PID controller uses for main zone control.

5.2.3.3.2.3 TEMP DER

The TEMP DER parameter is the main zone derivative, which is the derivative time in seconds that the instrument's PID controller uses for main zone control.

5.2.3.3.3 CAL REF (-P model only)

The CAL REF (REFERENCE INPUT CALIBRATION) menu is used to access the reference PRT calibration parameters. Use these parameters to adjust the measurement at 0 and 100Ω.

5.2.3.3.3.1 REF1C0

The REF1C0 parameter is the first calibration point for the reference resistance.

5.2.3.3.3.2 REF1C100

The REF1C100 parameter is the second calibration point for the reference resistance.

5.2.3.3.3.3 INPUT CAL DATE

The INPUT CAL DATE parameter is the calibration date for the readout. Use the arrow keys to enter the calibration date in the format selected in DATE FORMAT.

5.2.3.3.4 CAL UUT (-P model only)

The CAL UUT (UUT INPUT CALIBRATION) menu is used to access the applicable UUT calibration parameters. (The RTD had no calibration parameters.)

5.2.3.3.4.1 CAL TC

The TC (THERMOCOUPLE) input calibration menu contains the thermocouple calibration offsets.

5.2.3.3.4.1.1 TCC0

The TCC0 parameter adjusts the measurement at 0 mV. The value is in mV.

5.2.3.3.4.1.2 TCC100

The TCC100 parameter adjusts the measurement at 100 mV. The value is in mV.

5.2.3.3.4.1.3 TCCRJ

The TCCRJ parameter adjusts the reference junction temperature measurement. This parameter is in °C.

5.2.3.3.4.1.4 INPUT CAL DATE

The INPUT CAL DATE parameter is the calibration date for the readout. Use the arrow keys to enter the calibration date in the format selected in DATE FORMAT.

5.2.3.3.4.2 CAL mA

The mA input calibration menu contains the current loop calibration parameters.

5.2.3.3.4.2.1 mAC4

The mAC4 parameter adjusts the measurement at 4 mA.

5.2.3.3.4.2.2 mAC22

The mAC22 parameter adjusts the measurement at 22 mA.

5.2.3.3.4.2.3 INPUT CAL DATE

The INPUT CAL DATE parameter is the calibration date for the readout. Use the arrow keys to enter the calibration date in the format selected in DATE FORMAT.

5.2.3.4 SYSTEM INFO (view only)

The SYSTEM INFO (SYSTEM INFORMATION) menu displays manufacturer information regarding the instrument.

5.2.3.4.1 MODEL

The MODEL parameter displays the model number of the instrument.

5.2.3.4.2 SERIAL

The SERIAL (SERIAL NUMBER) parameter displays the serial number of the instrument.

5.2.3.4.3 FW VER

The FW VER (FIRMWARE VERSION0) parameter displays the firmware version used in the instrument.

5.2.3.4.4 CAL DATE

The CAL DATE (CALIBRATION DATE) parameter displays the calibration date of the heat source.

5.2.3.4.5 INPUT CAL DATE (-P model only)

The INPUT CAL DATE (-P CALIBRATION DATE) parameter displays the calibration date for the readout or the -P module.

5.2.4 INPUT SETUP (-P model only)

The INPUT SETUP menu allows all the parameters related to the -P module (process version) or readout function of the instrument to be accessed. The parameters found in this menu affect the performance, accuracy and display type of reference PRTs and UUTs used.

5.2.4.1 SELECT INPUT

The SELECT UUT INPUT menu (SENSOR TYPE) allows the user to select and enable the type of input that will be used as for the UUT.

5.2.4.1.1 SENSOR TYPE

The SENSOR TYPE parameter allows the user to select the type of sensor input. Use the left and right arrow keys to select the UUT input, TC, mA, or RTD, and press “Enter” to accept selection.

5.2.4.2 SETUP INPUT



NOTE: *The valid selections in the SETUP INPUT menu are based on the Sensor Type selected in the SELECT INPUT menu.*

The SETUP INPUT menu is used to set up the UUT input or to run the Test Algorithm.

5.2.4.2.1 RTD SETUP

The RTD SETUP menu is used to set up the parameters for the RTD input.

5.2.4.2.1.1 WIRES

The WIRES parameter allows the user to setup the RTD for 2, 3, or 4-wire input. Use the left and right arrow keys to select the number of wires and press “Enter” to accept the selection.

5.2.4.2.1.2 RTD TYPE

The RTD TYPE parameter is used to select the applicable conversion type for the RTD. Use the left and right arrow keys to select from the available options; RESISTANCE, PT100(385), PT100(3926), PT100(JIS), or NI-120. Press “Enter” to accept the selection.

5.2.4.2.2 TC SETUP

The TC SETUP parameter allows the user to select the thermocouple conversion type.

5.2.4.2.2.1 TC TYPE

The TC TYPE parameter is used to select the thermocouple conversion type. Standard thermocouple conversions include types C, E, J, K, L, M, N, R, S, T, and U.

When selecting mV the TC Type displays the measurement in volts rather than temperature.



NOTE: No cold-junction compensation is available. The cold junction compensation is measured at the input automatically computed and compensated for in the instrument.

Use the left and right arrow keys to select the thermocouple conversion type and press “Enter” to accept the selection.

5.2.4.2.3 mA SETUP

The mA SETUP parameter allows the user to enable the current loop.

5.2.4.2.3.1 LOOP POWER

The LOOP POWER parameter Enables or Disables the loop current. Use the left and right arrow keys to select and press “Enter” to accept the selection.

5.2.4.2.4 TEST CALC

The TEST CALC (TEST UUT CALCULATION) allows the technician to test the output of a specific conversion algorithm. Simply select the conversion type and enter a value for the requested parameter. Press ENTER, the algorithm computes the answer, and it is displayed immediately in the parentheses at the bottom of the screen, TEMPERATURE: XX.XXX.

5.2.4.3 REF INPUT

The REF INPUT (REFERENCE INPUT) menu contains the parameters for the reference input to the readout module of the instrument. The Reference Input is only compatible with PRTs with ITS-90, Callendar Van-Dusen, or IEC-751 coefficients. Additionally, the Reference Input will read straight resistance.

The probe serial number and coefficients can be found on the calibration certificate that was shipped with the probe. If the probe requires calibration, contact an Authorized Service Center to inquire about calibration services offered by Fluke Hart Scientific Division.

5.2.4.3.1 PROG PROBE

The PROG PROBE (REFERENCE PROBE SETUP) menu is used to setup the reference probe parameters.

5.2.4.3.1.1 SERIAL

The SERIAL (SERIAL NUMBER) parameter allows the user to enter ten digit alpha numeric serial number for the reference probe. Character range = {0-9, A-Z, ‘-’, <Blank>}. Minimum required is 1 character.

When a blank space is entered, any characters after the blank are dropped. For example, change S/N 1234-5678 to S/N TEST1. Enter TEST1<Blank Space>678. The serial number will drop the last three characters and enter the S/N TEST1.

5.2.4.3.1.2 CAL DATE

The CAL DATE parameter is used to enter the calibration date for the reference probe. Use the arrow keys to enter the calibration date in the format selected in DATE FORMAT.

5.2.4.3.1.3 PROBE TYPE

The PROBE TYPE parameter is used to choose which probe conversion type to be setup. Use the left and right arrow keys to select the conversion type and press “Enter” to accept selection.

5.2.4.3.1.3.1 TYPE (ITS-90)

The TYPE parameter can be ITS-90, Callendar Van-Dusen (CVD), IEC-751, or Resistance. The ITS-90 option is for PRTs calibrated and characterized using the International Temperature Scale of 1990 (ITS-90) equations. Subranges 4, and 7 through 11 are supported. The parameters that appear when ITS-90 is selected are “Serial” (Serial Number), “Cal Date”, “RTPW”, “COEF A”, “COEF B”, “COEF C”, “COEF A4”, and “COEF B4”. These should be set with the corresponding values that appear on the calibration certificate of the PRT. The parameter “RTPW” takes the triple point of water resistance, often labeled “R0” or “R(273.16K)” on the certificate. Parameters “COEF A”, “COEF B”, “COEF C” take the a_n , b_n and c_n coefficients where n is a number from 7 to 11. Parameters “COEF A4” and “COEF B4” take the a_4 and b_4 coefficients on the certificate. Any ITS-90 parameter of the instrument that does not have a corresponding coefficient on the PRT’s certificate must be set to 0.

The following table (Table 4) shows which parameter to set for each of the coefficients that may appear on the certificate. The example that follows demonstrates how to set the ITS-90 parameters for certain cases.

Table 4 Matching Certificate Values to 917X ITS-90 Coefficients

917X ITS-90 Coefficient	Certificate Value
COEF A	a7, a8, a9, a10, or a11
COEF B	b7, b8, b9, or 0
COEF C	c7 or 0
COEF A4	a4
COEF B4	b4



NOTE: If the certificate has two sets of coefficients, one set for “zero-power” calibration and one set for 1 mA calibration, use the coefficients for the 1 mA calibration.

Example 1:

A PRT was calibrated to ITS-90 and its calibration certificate states values for coefficients Rtpw, a4, b4, a8, and b8. Set the instrument’s parameters with values from the certificate as follows.

Table 5 Setting Coefficients Rtpw, a8, b8, and b4

917X Coefficient	Certificate Value
RTPW	Rtpw
COEF A	a8
COEF B	b8
COEF C	0
COEF A4	a4
COEF B4	b4

5.2.4.3.1.1 PROG PROBE

The PROG PROBE parameter is used to tell the instrument to program a Smart probe or Info-Con with the appropriate probe coefficients. Use the arrow keys to select “Yes” or “No”. If “Yes” is selected, the Smart probe (Info-Con) will be programmed with the appropriate coefficients for the selected conversion type. For ITS-90 and CVD, the coefficient values need to be entered before programming the Info-Con. For IEC751 and Resistance, no values are required to program the Info-Con.

5.2.4.3.1.2 TYPE (CVD)

The CVD (Callendar-Van Dusen) conversion is for RTD probes that use the Callendar-Van Dusen equation:

$$r(t[^\circ C]) = \begin{cases} R_0 \left\{ 1 + \alpha \left[t - \delta \frac{t}{100} \left(\frac{t}{100} - 1 \right) \right] \right\} & t \geq 0 \\ R_0 \left\{ 1 + \alpha \left[t - \delta \frac{t}{100} \left(\frac{t}{100} - 1 \right) - \beta \left(\frac{t}{100} - 1 \right) \left(\frac{t}{100} \right)^3 \right] \right\} & t < 0 \end{cases}$$

The parameters that appear when CVD is selected are “Serial” (Serial Number), “Cal Date”, “R0”, “ALPHA”, “DELTA” and “BETA”, which can be set by the user. For IEC-751, DIN-43760 or ASTM E1137 sensors, the coefficients for R0, ALPHA, DELTA, and BETA are 100.0, 0.00385055, 1.4998, and 0.1086 respectively.

Some probes may be provided with A, B, and C coefficients for the Callendar-Van Dusen equation in the following form:

$$r(t[^\circ C]) = \begin{cases} R_0 (1 + At + B^2) & t \geq 0 \\ R_0 [1 + At + Bt^2 + C(t-100)t^3] & t < 0 \end{cases}$$

The A, B, and C coefficients can be converted to Alpha, Beta and Delta coefficients using the following equation:

$$\alpha = A + 100B \quad \delta = -\frac{100}{\frac{A}{100B} + 1} \quad \beta = -\frac{10^8 C}{A + 100B}$$

5.2.4.3.1.3.2.1 PROG PROBE

The PROG PROBE parameter is used to tell the instrument to program a Smart probe or Info-Con with the appropriate probe coefficients. Use the arrow keys to select “Yes” or “No”. If “Yes” is selected, the Smart probe (Info-Con) will be programmed with the appropriate coefficients for the selected conversion type. For ITS-90 and CVD the coefficient values need to be entered before programming the Info-Con. For IEC751 and Resistance, no values are required to program the Info-Con.

5.2.4.3.1.3.3 TYPE (IEC751)

The IEC751 conversion is for RTD probes that use the International Electrotechnical Commission (IEC) Standard Publication 751.

5.2.4.3.1.3.3.1 PROG PROBE

The PROG PROBE parameter is used to tell the instrument to program a Smart probe or Info-Con with the appropriate probe coefficients. Use the arrow keys to select “Yes” or “No”. If “Yes” is selected, the Smart probe (Info-Con) will be programmed with the appropriate coefficients for the selected conversion type. For ITS-90 and CVD the coefficient values need to be entered before programming the Info-Con. For IEC751 and Resistance, no values are required to program the Info-Con.

5.2.4.3.1.3.4 TYPE (RESISTANCE)

The RESISTANCE option displays the resistance, in ohms, of the selected reference probe. This temporarily overrides the temperature conversion. The temperature conversion type can be restored without losing coefficients.

5.2.4.3.2 TEST CALC

The TEST CALC (TEST REFERENCE CALCULATION) allows the technician to test the output of a specific conversion algorithm. Simply select the conversion type and enter a value for the requested parameter. Press ENTER, the algorithm computes the answer, and it is displayed immediately in the parentheses at the bottom of the screen, TEMPERATURE: XX.XXX.

6 Digital communication interface

The Field Metrology Well is capable of communicating with and being controlled by other equipment through the RS-232 digital interface.

With a digital interface the instrument may be connected to a computer or other equipment. This allows the user to input the set-point temperature, monitor the temperature, communicate with the readout to obtain measurement data, control operating conditions and access any of the other controller functions, all using remote communications equipment. The RS-232 serial interface allows serial digital communications over fairly long distances. With the serial interface, the user may access any of the functions, parameters and settings discussed in this section.

6.1 Wiring

The serial communications cable attaches to the instrument through the DB-9 connector at the front of the instrument. Figure 17 on next page, shows the pin-out of this connector and suggested cable wiring. To eliminate noise, the serial cable should be shielded with low resistance between the connector (DB9) and the shield.

6.1.1 Setup

Before operation the serial interface must first be set up by programming the BAUD rate and other configuration parameters. These parameters are programmed within the communications menu. The serial interface parameters can be accessed from the main menu by MENU|SYSTEM MENU|SYSTEM SETUP|COMM SETUP|. For more information on the serial interface parameters, see Section 5.2.3.1.2 COMM SETUP on page 44.

6.1.2 Serial Operation

The serial communications uses 8 data bits, one stop bit, and no parity. The set-point and other commands may be sent via the serial interface to set the temperature set-point and view or program the various parameters. The interface commands are discussed in the “Digital Interface” section.

RS-232 Cable Wiring for IBM PC and Compatibles

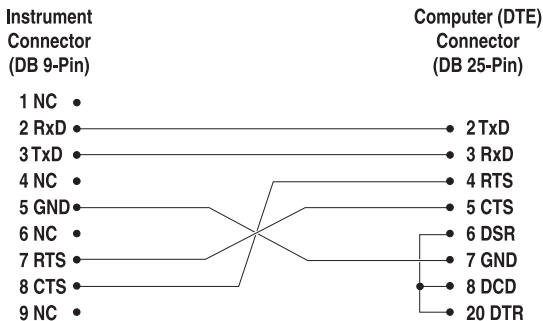
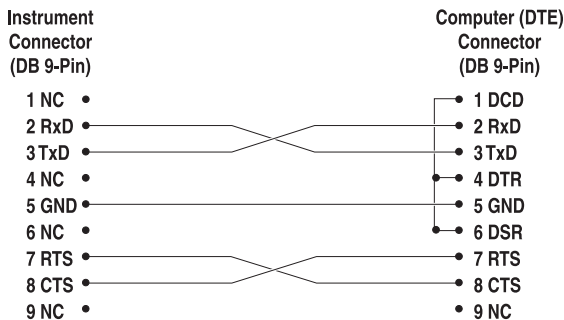

Figure 17 RS-232 wiring

6.2 Command Syntax

Field Metrology Wells accept commands for setting parameters, executing functions or responding with requested data. These commands are in the form of strings of ASCII-encoded characters. As far as possible, the Field Metrology Well command syntax conforms to SCPI-1994. One notable exception is that compound commands are not allowed as explained below.

Commands consist of a command header and, if necessary, parameter data. All commands must be terminated with either a carriage return (ASCII 0D hex or 13 decimal) or new line character (ASCII 0A hex or 10 decimal).

Command headers consist of one or more mnemonics separated by colons (:). Mnemonics may use letter characters, the underscore character (_), and possibly numeric digits as well. Commands are not case sensitive. Mnemonics often have alternate forms. Most mnemonics have a

long form that is more readable and a short form consisting of three or four characters that is more efficient.

A mnemonic may end with a numeric suffix that specifies one of a set of independent function blocks such as input channel data paths. If a numeric suffix is omitted when a particular block must be specified, an error is generated (“Header suffix out of range”).

Query commands are commands that request data in response. Query commands have a question mark (?) immediately following the command header. Responses to query commands are generated immediately and placed in the output buffer. Responses are then transmitted automatically over the RS-232 port. Responses are lost if not read before the next command is received.

Some commands require parameter data to specify values for one or more parameters. The command header is separated from the parameter data by a space (ASCII 20 hex or 32 decimal). Multiple parameters are separated by a comma(,).

Field Metrology Wells do not allow compound commands (multiple commands per line separated with semicolons). All commands are sequential. The execution of each command is completed before subsequent commands are processed.

6.3 Commands by Function or Group

In this section, the commands are arranged into the following groups:

Calibration Commands – commands for Field Metrology Well calibration parameters.

Main Screen Commands – commands for parameters displayed on the main screen.

Program Commands – commands for program setup and status.

Reference Commands – commands for accessing reference thermometer parameters.

UUT Commands – commands for accessing UUT parameters

Setup Commands – commands for setting up communication, display, password, measure, and operation parameters.

System Commands – commands to report and change the status of the instrument.

Temperature Commands – commands for control temperature and cutout functions.

Table 6 *Commands by Function or Group*

	SCREEN PARAMETER	Command	Password Protection Group	Read/Write
Calibration - Controller	TEMP PB	SOUR:LCON:PBAN	Unconditional	R/W
	TEMP INT	SOUR:LCON:INT	Unconditional	R/W
	TEMP DER	SOUR:LCON:DER	Unconditional	R/W
	CALDATE	CAL:DATE:UNIT	Unconditional	R/W

914X Field Metrology Wells

Commands by Function or Group

	SCREEN PARAMETER	Command	Password Protection Group	Read/Write
Calibration – Heat Source	TEMP 1	SOUR:SENS:CAL:PAR1	Unconditional	R/W
	TEMP 2	SOUR:SENS:CAL:PAR2	Unconditional	R/W
	TEMP 3	SOUR:SENS:CAL:PAR3	Unconditional	R/W
	GRAD 1	SOUR:SENS:CAL:GRAD1	Unconditional	R/W
	GRAD 2	SOUR:SENS:CAL:GRAD2	Unconditional	R/W
	GRAD 3	SOUR:SENS:CAL:GRAD3	Unconditional	R/W
	GRAD 4	SOUR:SENS:CAL:GRAD4	Unconditional	R/W
	GRAD 5	SOUR:SENS:CAL:GRAD5	Unconditional	R/W
	TEMP 1	SOUR:SENS:CAL:TEMP1	N/A	R
	TEMP 2	SOUR:SENS:CAL:TEMP2	N/A	R
TEMP 3	SOUR:SENS:CAL:TEMP3	N/A	R	
Calibration – Reference (-P model only)	REF1C0	SENS1:CAL:PAR1	Unconditional	R/W
	REF1C100	SENS1:CAL:PAR2	Unconditional	R/W
	INPUT CAL DATE	CAL:DATE:MOD	Unconditional	R/W
Calibration – UUT – TC (-P model only)	TCC0	SENS2:CAL:PAR1	Unconditional	R/W
	TCC100	SENS2:CAL:PAR2	Unconditional	R/W
	TCCRJ	SENS2:CAL:PAR3	Unconditional	R/W
	INPUT CAL DATE	CAL:DATE:MOD	Unconditional	R/W
Calibration – UUT-mA	mAC4	SENS2:CAL:PAR4	Unconditional	R/W
	mAC20	SENS2:CAL:PAR6	Unconditional	R/W
	INPUT CAL DATE	CAL:DATE:MOD	Unconditional	R/W
Main Screen	(none)	SOUR:SENS:DATA	N/A	R
	SETPT	SOUR:SPO	N/A	R/W
	STAB	SOUR:STAB:DAT	N/A	R
	STAB graph	SOUR:STAB:TEST	N/A	R
	HEAT %	OUTP1:DATA	N/A	R
	(none)	OUTP2:DATA	N/A	R
	ENABLE	OUTP1:STAT	N/A	R/W
(-P model only)	REF	CALC1:DATA	N/A	R
(-P model only)	REF TEMP	READ, MEAS, FETC	N/A	R
UUT (-P model only)	TC-n, P100, mA	CALC2:DATA	N/A	R
Program – Run	TEST STATUS	PROG:STAT	N/A	R/W
Program - List	(none)	PROG:CAT	N/A	R
Program - Select	(none)	PROG:TYP	N/A	R/W
Program - Setup	TEST ID	PROG:IDEN	N/A	R/W
	(none)	PROG:MEM:COUN	N/A	R
Erase Tests	ERASE TESTS	PROG:MEM:CLEA	Unconditional	W

	SCREEN PARAMETER	Command	Password Protection Group	Read/Write
Ramp & Soak	RAMP/SOAK SETUP	PROG:SEQ:CAT	N/A	R
	SETPOINT n	PROG:SEQ:PAR SPOn	Conditional	R/W
	SOAK TIME	PROG:SEQ:PAR DWEL	Conditional	R/W
	SETPOINTS	PROG:SEQ:PAR POIN	Conditional	R/W
	NO CYCLES	PROG:SEQ:PAR CYCL	Conditional	R/W
	PASS TOLERANCE	PROG:SEQ:PAR PTOL	Conditional	R/W
	DIRECTION	PROG:SEQ:PAR DIR	Conditional	R/W
	SETPOINT 1	SOUR:LIST:SPO1	N/A	R/W
	SETPOINT 2	SOUR:LIST:SPO2	N/A	R/W
	SETPOINT 3	SOUR:LIST:SPO3	N/A	R/W
	SETPOINT 4	SOUR:LIST:SPO4	N/A	R/W
	SETPOINT 5	SOUR:LIST:SPO5	N/A	R/W
	SETPOINT 6	SOUR:LIST:SPO6	N/A	R/W
SETPOINT 7	SOUR:LIST:SPO7	N/A	R/W	
SETPOINT 8	SOUR:LIST:SPO8	N/A	R/W	
Switch Test – List Parameters	(none)	PROG:SWIT:CAT	N/A	R
Input State	(none)	INP:SWIT:CLOS	N/A	R
Auto Test	SWITCH TEMP	PROG:SWIT:PAR TNOM	N/A	R/W
Manual Test	LOWER TEMP	PROG:SWIT:PAR TLOW	N/A	R/W
	UPPER TEMP	PROG:SWIT:PAR THIG	N/A	R/W
	APPROACH LIMIT	PROG:SWIT:PAR APPR	N/A	R/W
	NO OF CYCLES	PROG:SWIT:PAR CYCL	N/A	R/W
Test – Results (-P model only)	PRINT TEST	PROG:MEM:PRINT	N/A	W
	ERASE TESTS	PROG:MEM:CLEA	Unconditional	W
Reference - List (-P model only)	PROBE TYPE	CALC1:CONV:CAT	N/A	R
Characterization Parameters - Active List (-P model only)	(none)	CALC1:CONV:PAR:CAT	N/A	R
	CAL DATE	CALC1:CONV:DATE	Conditional	R/W
	PROGRAM	CALC1:CONV:PROG	Unconditional	W
Reference – Setup (-P model only)	PROBE TYPE: ITS-90	CALC1:CONV:NAME ITS-90	Conditional	R/W
Reference – Setup (-P model only)	PROBE TYPE: CVD	CALC1:CONV:NAME CVD	Conditional	R/W
Reference – Setup (-P model only)	PROBE TYPE: IEC	CALC1:CONV:NAME IEC-751	Conditional	R/W
Reference – Setup (-P model only)	CONV TYPE: RESISTANCE	CALC1:CONV:NAME RES	Conditional	R/W
(-P model only)	SERIAL	CALC1:CONV:SNUM	Conditional	R/W
ITS90 (-P model only)	RTPW	CALC1:CONV:PAR:VAL RTPW	Conditional	R/W
	A	CALC1:CONV:PAR:VAL A7	Conditional	R/W
	B	CALC1:CONV:PAR:VAL B7	Conditional	R/W
	C	CALC1:CONV:PAR:VAL C7	Conditional	R/W
	A4	CALC1:CONV:PAR:VAL A4	Conditional	R/W
	B4	CALC1:CONV:PAR:VAL B4	Conditional	R/W

914X Field Metrology Wells

Commands by Function or Group

	SCREEN PARAMETER	Command	Password Protection Group	Read/Write
CVD (-P model only)	R0	CALC1:CONV:PAR:VAL R0	Conditional	R/W
	ALPHA	CALC1:CONV:PAR:VAL AL	Conditional	R/W
	DELTA	CALC1:CONV:PAR:VAL DE	Conditional	R/W
	BETA	CALC1:CONV:PAR:VAL BE	Conditional	R/W
	RESISTANCE	SENS1:DATA	N/A	R
Reference – Test Algorithm (-P model only)	TEST CALC	CALC1:CONV:TEST	N/A	R
UUT (-P model only)	RES, mA, mV	SENS2:DATA	N/A	R
	SENSOR	SENS2:FUNC	N/A	R/W
List (-P model only)	RTD TYPE	CALC2:CONV:CAT RTD	N/A	R
	TC TYPE	CALC2:CONV:CAT TC	N/A	R
	RTD TYPE: RESISTANCE	CALC2:CONV:NAME 0	N/A	R/W
	RTD TYPE: PT100(385)	CALC2:CONV:NAME 1	N/A	R/W
	RTD TYPE: PT100(3926)	CALC2:CONV:NAME 2	N/A	R/W
	RTD TYPE: PT100(JIS)	CALC2:CONV:NAME 3	N/A	R/W
	RTD TYPE: NI-120	CALC2:CONV:NAME 4	N/A	R/W
	TC-C	CALC2:CONV:NAME C	N/A	R/W
	TC-E	CALC2:CONV:NAME E	N/A	R/W
	TC-J	CALC2:CONV:NAME J	N/A	R/W
	TC-K	CALC2:CONV:NAME K	N/A	R/W
	TC-L	CALC2:CONV:NAME L	N/A	R/W
	TC-M	CALC2:CONV:NAME M	N/A	R/W
	TC-N	CALC2:CONV:NAME N	N/A	R/W
	TC-R	CALC2:CONV:NAME R	N/A	R/W
	TC-S	CALC2:CONV:NAME S	N/A	R/W
	TC-T	CALC2:CONV:NAME T	N/A	R/W
	TC-U	CALC2:CONV:NAME U	N/A	R/W
mV	CALC2:CONV:NAME MV	N/A	R/W	
UUT–mA (-P model only)	LOOP POWER	INP2:MAMP:LPOW	N/A	R/W
UUT–RTD (-P model only)	WIRES	INP2:RTD:WIR	N/A	R/W
UUT – Test Algorithm (-P model only)	TEST CALC	CALC2:CONV:TEST	N/A	R
Setup - Communication	BAUD RATE	SYST:COMM:SER:BAUD	N/A	R/W
	LINEFEED	SYST:COMM:SER:LIN	N/A	R/W
Setup - Display	LANGUAGE	SYST:LANG	N/A	R/W
	DECIMAL	SYST:DEC:FORM	N/A	R/W
	KEY AUDIO	SYST:BEEP:KEYB	N/A	R/W
Setup - Password	PASSWORD (Disable)	SYST:PASS:CDIS	Unconditional	W
	PASSWORD (Enable)	SYST:PASS:CEN	Unconditional	W
Status	(none)	SYST:PASS:CEN:STAT	N/A	R
	USER PASSWORD	SYST:PASS:NEW	Unconditional	W
	PROTECTION	SYST:PASS:PROT	N/A	R/W
Setup – Date/Time	DATE	SYST:DATE	Unconditional	R/W
	TIME	SYST:TIME	Unconditional	R/W
System - Setup	°C/°F key	UNIT:TEMP	N/A	R/W

	SCREEN PARAMETER	Command	Password Protection Group	Read/Write
Heat Enable	(none)	OUP:STAT	N/A	R/W
	(none)	SYST:KLOC	Conditional	R/W
	(none)	SYST:CONF:MOD	N/A	R
System - Information	(none)	SYST:ERR	N/A	R
	(all)	*IDN	N/A	R
	(none)	*CLS	N/A	W
	(none)	*OPT	N/A	R
	FW VER	SYST:COD:VERS	N/A	R
	(none)	SYST:BEEP:IMM	N/A	W
Temperature – Cutout	HARD CUTOUT	SOUR:PROT:HCUT	N/A	R
	SOFT CUTOUT	SOUR:PROT:SCUT:LEV	Conditional	R/W
Reset	(none)	SOUR:PROT:CLE	N/A	W
Trip State	(none)	SOUR:PROT:TRIP	N/A	R
Temperature - Setup	SCAN RATE	SOUR:RATE	N/A	R/W
	STABLE LIMIT	SOUR:STAB:LIM	N/A	R/W
	STABLE ALARM	SOUR:STAB:BEEP	N/A	R/W

6.4 Serial Commands - Alphabetic Listing

Each command description provides the structure (long and short format), a description of the command purpose, a command example, an example of what the command returns (as applicable to query commands), and notes specific to the command. The following apply to each group of commands:

- Numeric data, specified by the mnemonic, <num>, uses ASCII characters to represent numbers. Numbers may contain a plus or minus ('+' or '-') sign, decimal point ('.'), and exponent ('E' or 'e') with its sign. If a fractional component is received when only an integer is required, the number is rounded to the nearest integer without any resulting error message. The mnemonics DEF, MIN, and MAX are often acceptable for the default, minimum, and maximum value respectively. Unit suffixes, such as V or OHM, can be appended to numeric parameters and are accepted without error but ignored.
- Unrecognized commands or commands with incorrect syntax or invalid parameters generate error messages in the error queue.
- Upper case letters designate syntax that is required when issuing the command. Lower case letters are optional and may be omitted.
- <> indicates a required parameter.
- [] indicates optional parameters.
- () indicates a group of parameters that must be used together.
- For query commands, specifying the MIN, MAX, or DEF parameter causes the instrument to respond with the minimum, maximum, or default setting respectively.
- For set commands, specifying the MIN, MAX, or DEF parameters causes the instrument to use the minimum, maximum, or default setting respectively.
- '|' indicates alternate parameter values.
- <n> indicates a number is required.
- <num> indicates numeric value is required.

914X Field Metrology Wells

Serial Commands - Alphabetic Listing

- <prog> indicates a program number (SEQ<n> or SWIT<n>) is required.
- <bool> indicates a Boolean value (0 or 1) is required. The mnemonics OFF and ON are also accepted for 0 and 1, respectively.
- <conv> indicates a conversion mnemonic is required.
- <param> indicates a parameter name is required.
- <seri> indicates a serial number is required.
- <res> indicates a resistance value is required.
- <volt> indicates a voltage value is required.
- <unit> indicates a temperature unit is required.
- <temp> indicates a temperature °C/F is required.
- <pass> indicates a password is required.
- <port> indicates a port number is required.
- <label> indicates an eight character label is required.
- <year> indicates a four digit number is required.
- <month> indicates a one or two digit number is required.
- <day> indicates a one or two digit number is required.
- <hour> indicates a one or two digit number is required.
- <minute> indicates a one or two digit number is required.
- <second> indicates a one or two digit number is required.
- <baud> indicates a valid baud number is required.

***CLS**

Clear the status registers

Example: *CLS

This command has no response.

Clears all status registers (events, operations etc).

***IDN?**

Read the product information (Manufacturer, Model Number, Serial Number, and Firmware Version)

Example: *IDN?

Response: HART,9142,A79002,1.00

***OPT?**

Read the product configuration, reference hardware enabled (1) or not (0) (see SYST:CONF:MOD) plus Russian configuration set (2) or not (0)

Example: *OPT?

Response: 1

This command is a read only command and returns the state of the reference functionality (0, 1).

CAL:DATE:MOD[?] [<year>,<month>,<day>] (-P model only)



NOTE: This command is unconditionally protected, which requires a password to set it.

Read or set the calibration date for the –P Module (INPUT CALibration DATE) where the entered values are all numeric and “yyyy” is a four digit year (2000-2135), “mm” is a two digit month (1-12), and “dd” is a two digit day (1-31)

Read Example: CAL:DATE:MOD?

Response: 2007,05,24

Set Example: CAL:DATE:MOD 2007,12, 30

This command reads or sets the calibration date for the –P module including all accompanying sensors.

CAL:DATE:UNIT[?] [<year>,<month>,<day>]



NOTE: This command is unconditionally protected, which requires a password to set it.

Read or set the calibration date for the Main Unit where the entered values are all numeric and “yyyy” is a four digit year (2000-2135); default 2007, “mm” is a two digit month (1-12), and “dd” is a two digit day (1-31)

Read Example: CAL:DAT:UNIT?

Response: 2007,05,24

Set Example: CAL:DAT:CAL 2006,12, 30

This command reads or sets the calibration date for the Main Unit. Calibration is for the heat source portion of the instrument.

CALC1:CONV:CAT? (-P model only)

Read the list of reference probe characterization methods, “CVD, I90, IEC, RES”

Example: CALC1:CONV:CAT?

Response: “CVD”, ”I90”, ”IEC”, ”RES”

Provides the list of PRT/RTD characterization methods available.

CALC1:CONV:DATE[?] [<yyyy,mm,dd>] (-P model only)



NOTE: This command is conditionally protected, which requires a password to set it.

Read or set the InfoCon probe calibration date in yyyy,mm,dd format

Year Range = {2000 – 2135}; Default: 2007

Month Range = {1 – 12}; Default: 1

Day Range = {1 – 31}; Default: 1

Read Example: CALC1:CONV:DATE?

Response: 2007,10,09

Set Example: CALC1:CONV:DATE 2007,09,06

This command reads or sets the calibration date for the InfoCon probe.

CALC1:CONV:NAME[?][n] (-P model only)



NOTE: This command is conditionally protected, which requires a password to set it.

Read or set the reference probe characterization method where “n” is an alpha numeric value; CVD, I90, IEC, and RES. Range={ITS90, CVD, IEC, RES} or 0-3, Default:ITS90

Read Example: CALC1:CONV:NAME?

Response: CVD

Set Example: CALC1:CONV:NAME I90

Reads or sets the reference probe characterization method from a predefined set of options.

CALC1:CONV:PAR:CAT? (-P model only)

Read the list of active reference probe characterization parameter names

Example: CALC1:CONV:PAR:CAT?

Response: “RTPW”,”A”,”B”,”C”,”A4”,”B4”

This command is a read only command, which returns the active parameters for the current reference probe type.

CALC1:CONV:PAR:VAL[?] par[,<n>] (-P model only)



NOTE: This command is conditionally protected, which requires a password to set it.

Read or set a reference probe characterization parameter. Where “par” is a parameter identified as follows: ITS90: RTPW, A7, B7, C7, A4, B4; or CVD: AL, DE or BE. “n” may be some real number or an exponential value such as -1.234567e-5 for ITS-90

ITS-90 Ranges: {RTPW, A7, B7, A4, B4} or 0 - 5

RTPW = 1.0 to 200 ohms

Coefficients = ± 0.010

Defaults: RTPW = 100
All ITS-90 coefficients = 0.00000
CVD Ranges/Defaults: {R0, AL, DE, BE} or 0 - 3
R0 = 1.0 to 200.00 ohms
R0 Default = 100.00
AL Range = 0.1 to 0.9
AL Default = 0.00385055
BE Range = 0.0 to 1.0
BE Default = 0.10863
DE Range = 0.0 to 2.0
DE Default = 1.499786

Read Example: CALC1:CONV:PAR:VAL? RTPW

Response: 100.4545

Set Example: CALC:CONV:PAR:VAL A7, 0.00385075

This command returns a reference probe characterization parameter as desired by the user.

CALC1:CONV:PROG (-P model only)



***NOTE:** This command is unconditionally protected, which requires a password to set it.*

Program the InfoCon probe with the current probe settings

Example: CALC1:CONV:PROG

CALC1:CONV:SNUM[?] <ser_num> (-P model only)



***NOTE:** This command is conditionally protected, which requires a password to set it.*

Read or set the reference probe serial number, where “ser_num” character range equals {0-9, A-Z, ‘-’}, up to 10 characters in length with a minimum of 1 character length. Default: “0”

When a blank space is entered, any characters after the blank are dropped. For example, change S/N 1234-5678 to S/N TEST1. Enter TEST1<Blank Space>678. The serial number will drop the last three characters and enter the S/N TEST1.

Read Example: CALC1:CONV:SNUM?

Response: 1234

Set Example: CALC1:CONV:SNUM 1560-D

This command allows the user to read or enter a reference probe serial number.

CALC1:CONV:TEST[?] <n>]

Test the conversion algorithm from resistance (ohms) to temperature (°C or °F). “n” is the value to be converted (ohms); entry for “n” is required for converted output. Range = {0-500}; Default = 100

Read Example: CALC1:CONV:TEST? 100.000

Response: 0.0100

This is a read only command and tests conversion algorithm from resistance to temperature.

CAL1:DATA? (-P model only)

Reads the reference sensor Temperature. The returned value will be in degrees °C (°F) if a temperature value is returned. The value may be resistance depending on the conversion selection

Example: CALC1:DAT?

Response: 325

The command returns an instantaneous reading of the reference sensor Temperature.

CALC2:CONV:CAT? <func> (-P model only)

Read the list of UUT probe characterization names. Where “func” is the UUT device, “func” is not required and will default to the selected device based on the setting of <SENS2:FUNC>. Range = {RTD, TC, MA}, Default = RTD (if no previous selection), else current selection

Example 1: CALC2:CONV:CAT? TC

Response: “C”, “E”, “J”, “K”, “L”, “M”, “N”, “R”, “S”, “T”, “U”, “mV”

If SENS2:FUNC is set to RTD and the command is sent without the function:

Example 2: CAL2:CONV:CAT?

Response: “PT_A385”, “PT_A392”, “PT_JIS”, “NI_120”, “RES”

CALC2:CONV:NAME[?] n] (-P model only)

Read or set the UUT device characterization scheme. Must be consistent with the selected Function and device. For RTD: “n” is the RTD type as follows: PT_A385; PT_A392; PT_JIS; NI_120; or RES. For TC; “n” is the thermocouple type as follows: C; E; J; K; L; M; N; R; S; T; U; or mV. Default: RTD, PT_A385

Read Example: CALC2:CONV:NAME?

Response: RTD

Set Example: CALC2:CONV:NAME NI_120

Command responds with the selected UUT probe characterization method; RES, I90, IEC, RES, mV, or mA.

CALC2:CONV:TEST? n,[rj] (-P model only)

Test the conversion algorithm from the UUT input.

Example: CALC2:CONV:TEST? 100.0

Response: 0.0000

For thermocouple input, “rj” is the reference junction temperature. If this is not indicated, it is assumed to be 0°C.

CALC2:DATA? (-P model only)

Read the UUT sensor Temperature. The returned value will be in degrees C (°F) if a temperature value is returned. Value may be resistance, mV, or mA depending on the selected SENS function and conversion selection.

Example: CALC2:DATA?

Response: 325

The command returns an instantaneous reading of the UUT sensor Temperature.

INP:SWIT:CLOS?

Read the switch input state, open (0) or closed (1).

Example: INP:SWIT:CLOS?

Response: 0

This command returns a 0 if the switch is open and a 1 if the switch is closed.

INP2:MAMP:LPOW[?] [0|1] (-P model only)

Read or set UUT module mA source where [0] is Passive and [1] enables Loop Power. Default = 0 (Passive)

Read Example: INP2:MAMP:LPOW?

Response: 1

Set Example: INP2:MAMP:LPOW 1

Command reads or sets the state of the mA current source loop.

INP2:RTD:WIR[?] [n] (-P model only)

Read or set the UUT module number of wires in RTD where “n” is the number of wires. Range = { 2, 3, 4}; Default = 4 wires

Read Example: INP2:RTD:WIR?

Response: 3

Set Example: INP2:RTD:WIR 4

Sets the appropriate number of wires for the UUT RTD.

OUTP:STAT[?] [0|1]

Read or set the Main Heat output enable, off [0] or on [1]

Read Example: OUTP:STAT?

Response: 0

Set Example: OUTP:STAT 1

This command reads or sets the active heating or cooling output status. A “0” is returned if the output status is off, and a “1” is returned if the output status is on

OUTP1:DATA?

Read the main heat output percent

Example: OUTP1:DATA?

Response: 18.0

This command returns the current main zone heater duty cycle

OUTP2:DATA?

Read the gradient heat output percent

Example: OUTP2:DATA?

Response: 57.0

This command returns the current top zone heater percent power.

PROG:CAT?

A catalog list of all define programs: Ramp & Soak = SEQ, Auto Switch Test = ASW, and Manual Switch Test = MSW

Example: PROG:CAT?

Response: “SEQ”,”ASW”,”MSW”

PROG:IDEN[?] [n]

Read or set the program identifier. Character range = {0 – 9, A – Z, ‘-’}, up to 12 characters, minimum 1 character: Default: “0”

Read Example: PROG:IDEN?

Set Example: TEST-1

PROG:MEM:CLE (-P Model only)



***NOTE:** This command is unconditionally protected, which requires a password to set it.*

Erase all test reports stored in NVMemory

Example: PROG:MEM:CLE

PROG:MEM:COUN? (-P Model only)

Read the test report count.

Example: PROG:MEM:COUN? 6

Provide the count for the number of test reports currently stored in memory.

PROG:MEM:PRIN [n] [ALL] (-P Model only)

Prints one or ALL test reports. Where “n” indicates the test report to be printed and 1 is the earliest test.

Example: PROG:MEM:PRINT 1

PROG:SEQ:CAT?

Read a list of program parameters for Ramp & Soak tests

Example: PROG:SEQ:CAT?

Response: “SPOn”, ”DWELL”, ”DIR”, ”POIN”, ”CYCL”, ”PTOL”

This command provides a list of the parameters for the Ramp and Soak test.

PROG:SEQ:PAR? par[,<n>]

Read or set a program parameter for Ramp & Soak tests. Range = {SPOn, DWELL, DIR, POIN, CYCL, PTOL}.

Table 7 PROG:SEQ:PAR parameters

Parameter	Min	Max	Default
SPO[n]*	1	8	1
DWEL	1	100	15
POIN	1	8	8
CYCL	1	999	1
PTOL	0.01	99.9	1.00
DIR	0 (up)	1 (U/D)	0

*Read Only, must be <= # of setpoints (POIN)

Read Example: PROG:SEQ:PAR? dwell

Response: 25

Set Example: PROG:SEQ:PAR cycle,8

Reads or sets a specified parameter in the Ramp & Soak test.

PROG:STAT[?] [0|1]

Read or set the execution state for the selected program. (Off=0, Run=1) Default = 0

Read Example: PROG:STAT?

Response: 0

Set Example: PROG:STAT 1

If the selected program is not running then a value of 0 is returned otherwise a 1 is returned.

PROG:SWIT:CAT?

Read a list of program parameters for the switch test (TLOW, THIG, TNOM, APPR, AND CYCL)

Example: PROG:SWIT:CAT?

Response: "TLOW","THIG","TNOM","APPR","CYCL"

Command provides the current values for the switch test parameters: TLOW = Lower Temp, THIG = Upper Temp, TNOM = Nominal Temp, APPR = Approach Limit, and CYCL = No. of Cycles.

PROG:SWIT:PAR? par[,<n>]

Read or set a program parameter for the switch test where "par" is the parameter (TLOW, THIG, TNOM, APPR, or CYCL) and "n" is the value.

Table 8 PROG:SWIT:PAR parameters

Parameter	Min	Max	Default
TLOW			
9142	-25.00	150.00	25.00
9143	25.00	350.00	25.00
9144	25.00	660.00	25.00
THIG			10.00
9142	-25.00	150.00	-15.00
9143	25.00	350.00	35.00
9144	25.00	660.00	35.00
TNOM			
9142	-25.00	150.00	-15.00
9143	25.00	350.00	35.00
9144	25.00	660.00	35.00
APPR	0.0	999.9	0.0
CYCL	1	100	1

Read Example: PROG:SWIT? tlow

Response: -25

Set Example: PROG:SWIT? TLOW,36.5

Command provides or sets the current value for the specified switch test parameter: TLOW = Lower Temp, THIG = Upper Temp, TNOM = xxx, APPR = Approach Limit, and CYCL = No. of Cycles.

PROG:TYPE[?] [<prog>]

Read or select a program to run where “prog” is a name, SEQ, ASW, or MSQ. Default = SEQ

Read Example: PROG:TYPE?

Response: SEQ

Set Example: PROG:TYPE ASW

Reads or selects the current program setting, Ramp & Soak = SEQ, Auto Switch Test = ASW, or Manual Switch Test = MSW.

READ?, MEAS? or FETC? (-P model only)

Read the Reference sensor temperature, °C or °F

Example: READ?

Response: 264.262

If the external reference probe is enabled, the reference temperature is returned otherwise 0.0 is returned.

SENS1:CAL:PAR<n>?|[cal] (-P model only)

NOTE: This command is unconditionally protected, which requires a password to set it.

Read or set a reference input calibration parameter where “n” is a value of 1 or 2 corresponding to the calibration parameters REF1C0 and REF1C100 respectively. “cal” is a real number used as the calibration offset for the respective parameter

REF1C0 Range = {-1.0 to 1.0}

REF1C100 Range = {-2.0 to 2.0}

Defaults (all): 0.0000

Read Example: SENS:CAL:PAR1?

Response: 0.2

Set Example: SENS1:CAL:PAR2 0.092

Reference thermometer input commands to verify or set REF1C0 (PAR1) or REF1C100 (PAR2) calibration parameters.

SENS1:DATA? (-P model only)

Read the reference input resistance

Example: SENS1:DATA?

Response: 199.9366

This command returns the resistance in ohms of the reference probe.

SENS2:CAL:PAR<n>[?] [cal] (-P model only)



NOTE: This command is unconditionally protected, which requires a password to set it.

Read or set the UUT input calibration parameter for the selected function where “n” is an integer 1-6. PAR1=TCC0, PAR2=TCC100, PAR3=TCCRJ, PAR4=mAC4, and PAR6=mAC22 respectively. “cal” is a real number used as the calibration offset for the respective parameter

Range: TC = ± 10.00 (mV)

mA = ± 4.00 (mA)

Default: TC = ± 0.00 (mV)

mA = ± 0.00 (mA)

Read Example: SENS2:CAL:PAR1?

Response: 0.2

Set Example: SENS:CAL:PAR2 0.092

UUT input commands to verify or set TCC0 (PAR1), TCC100 (PAR2), TCCRJ (PAR3) for the thermocouple (TC) function calibration parameters and mAC4 (PAR4), and mAC20 (PAR6) for the mili-amp (mA) function calibration parameters.

SENS2:DATA? (-P model only)

Read the UUT input. The returned value units will be according to function: PRT/RTD will be in resistance; TC will be in mV; mA will be in mA

Example: SENS2:DATA?

Response: 0.03

This command returns the UUT input in ohms for the PRT/RTD function, mV for the thermocouple function, and mA for the current loop function.

SENS2:FUNC[?] [par] (-P model only)

Read or set the UUT Sense Function (device) selection where “par” is the selected device and is entered as RTD, TC or MA. Default = RTD

Read Example: SENS2:FUNC?

Response: RTD

Set Example: SENS2:FUNC TC

This command reads or sets the UUT Sense Function as, RTD, TC, or mA.

SOUR:LCON:DER[?] [n]



NOTE: This command is unconditionally protected, which requires a password to set it.

Read or set the main control loop derivative time in seconds, Min: 0.0, Max: 99.9

Read Example: SOUR:LCON:DER?

Response: 1.5

Set Example: SOUR:LCON:DER 5

The main zone derivative is the derivative time in seconds that the instrument's PID controller uses for main zone control.

SOUR:LCON:INT[?] [n]



NOTE: This command is unconditionally protected, which requires a password to set it.

Read or set the main control loop integral time in seconds. Range = {10.0-999.9}

Read Example: SOUR:LCON:INT?

Response: 20.0

Set Example: SOUR:LCON:INT 10

The main zone integral is the integration time in seconds that the instrument's PID controller uses for main zone control.

SOUR:LCON:PBAN[?] [n]



NOTE: This command is unconditionally protected and requires a password to set it.

Read or set the main control loop proportional band, °C. Range = {1.0-99.9}

Read Example: SOUR:LCON:PBAN?

Response: 1.5

Set Example: SOUR:LCON:PBAN 7

The main zone proportional band is the gain in °C that the instrument's proportional-integral-derivative (PID) controller uses for main zone control.

SOUR:LIST:SPO<i>[?] [n]

Read or set a main temperature preset set-point

Read example: SOUR:LIST:SPO6?

Response: 25.00

Set Example: SOUR:LIST;SPO6 100.00

This sets the preset set-points found in PROG MENU under RAMP/SOAK.

SOUR:PROT:HCUT?

Read the hard cutout temperature set-point in °C or °F

Read Example: SOUR:PROT:HCUT?

Response: 140

Returns the current value of the hard cutout set-point.

SOUR:PROT:CLEA

Reset the cutout to enable the system

Example: SOUR:PROT:CLEA

This command has no response.

If the Field Metrology Well exceeds the temperature set in the soft cutout menu or if it exceeds the maximum operating temperature of the instrument, a cutout condition occurs. If this happens, the instrument enters cutout mode and will not actively heat or cool until the user issues this command to clear the cutout or resets the instrument using the Setpt. key to clear the cutout mode and activate the instrument.

SOUR:PROT:SCUT:LEV[?] [n]



NOTE: This command is conditionally protected and requires a password to set it.

Read or set the soft cutout set-point where “n” is an integer value from 0 to 700

9142 Range = {-25.00 to 165.00}

9143 Range = {25.00 to 365.00}

9144 Range = {25.00 to 670.00}

Read Example: SOUR:PROT:SCUT:LEV?

Response: 125

Set Example: SOUR:PROT:SCUT:LEV 450

Read or set the soft cutout set-point. The soft cutout should be set to protect the temperature limits of the instruments under test.

SOUR:PROT:TRIP?

Read the temperature cutout tripped state. Range = {0, 1}; 0 = No Cutout; 1 = Cutout

Example: SOUR:PROT:TRIP?

Response: 0

A value of 0 is returned if the cutout set point has not been reached. Otherwise a value of 1 is returned and the cutout set point has been reached.

SOUR:RATE[?] [n]

Read or set the control temperature rate of change (Scan Rate), °C or °F per minute. Min: 0.10, Max: 500.00; Default: 100.00

Read Example: SOUR:RATE?

Response: 0.531

Set Example: SOUR:RATE 1.26

The response to this command starts out high initially and decreases as the set point is reached.

SOUR:SENS:CAL:GRAD<x>[?] [n]



NOTE: This command is unconditionally protected and requires a password to set it.

Read or set the axial gradient control parameter, where “x” is a numeric value indicating the parameter. [1] = GRAD1 = GRAD 1, [2] = GRAD2 = GRAD 2, [3] = GRAD3 = GRAD 3, [4] = GRAD4 = GRAD 4, [5] = GRAD5 = GRAD 5. “n” is a real number ranging from -1.0 to 1.0 entered as a ratio of the main heater power

Read Example: SOUR:SENS:CAL:GRAD2?

Response: 0.05

Set Example: SOUR:SENS:CAL:GRAD2 0.08

The top zone heater reacts as a ratio of the mains heater power to control the axial gradient.

SOUR:SENS:CAL:PAR<x>[?] [n]



NOTE: This command is unconditionally protected and requires a password to set it.

Read or set a control temperature calibration parameter, where “x” is a numeric value indicating the parameter. [1] = PAR1=Temp 1, PAR2=Temp 2, PAR3=Temp 3. “n” is the entered value of the parameter. Range = ±50.00; Defaults: 0.000

Read Example: SOUR:SENS:CAL:PAR1?

Response: 0.0

Set Example: SOUR:SENS:CAL:PAR2 0.02

This command reads or sets the calibration parameter value for main control. See the “Calibration of your Field Metrology Well” section for more detail.

914X Field Metrology Wells

Serial Commands - Alphabetic Listing

SOUR:SENS:CAL:TEMP<x>?

Read the required calibration temperature (°C) corresponding to a calibration parameter where “x” is a numeric value indicating the parameter [1] = TEMP1, [2] = TEMP2, AND [3] = TEMP3. Range = {1-3}; Default = 1

Example: SOUR:SENS:CAL:TEMP1?

Response: 40

SOUR:SENS:DATA? [TEMP]

Read the control temperature, °C or °F

Example: SOUR:SENS:DATA? or SOUR:SENS:DATA? TEMP

Response: 30.285°C (current control temp)

The current control temperature is returned if the above or if TEMP is appended to the end of the example.

SOUR:SENS:DATA? [RES]

Read the control sensor resistance

Example: SOUR:SENS:DATA? RES

Response: 111.28

When RES is appended to the end of the example above, the internal sensor resistance is returned.

SOUR:SPO[?] [n]

Set the control set-point, °C or °F, where “n” is a real value with acceptance limits based on the model

Parameter	Min	Max	Default
9142	-25.00	150.00	25.00
9143	25.00	350.00	25.00
9144	25.00	660.00	25.00

Read Example: SOUR:SPO?

Response: 50.000

Set Example: SOUR:SPO 100.00

This command reads or sets the value of the control set point based on the system temperature units.

SOUR:STAB:BEEP[?] [n]

Read or set the stability alert (beep) enable where “n” is a value 0 or 1. [0] is disable, [1] is enable beep. Default: 1 (Enable Beep)

Read Example: SOUR:STAB:BEEP?

Response: 1

Set Example: SOUR:STAB:BEEP 0

Enable or disable the audible stability alert.

SOUR:STAB:DAT?

Read the control temperature stability, °C or °F

Example: SOUR:STAB:DAT?

Response: 0.306

The controller stability is returned.

SOUR:STAB:LIM[?] [n]

Read or set the control temperature stability limit, °C or °F where “n” is a positive real value. Range = {0.01 to 9.99 (°C)}; Default: 0.05 (°C)

Read Example: SOUR:STAB:LIM?

Response: 0.05

Set Example: SOUR:STAB:LIM 0.03

Read or set the control stability limit.

SOUR:STAB:TEST?

Read the temperature stability test results. Stable = 1; Unstable = 0

Example: SOUR:STAB:TEST?

Response: 0

A value of 0 is returned if the controller is not stable at the current set-point. Otherwise a value of 1 is returned if the controller is stable at the current set-point.

SYST:BEEP:IMM

Beep the system beeper

Example: SYST:BEEP:IMM

The system beeper should make an audible sound in response to this command.

SYST:BEEP:KEYB[?] [n]

Read or set the keyboard beep function, 0=Off, 1=On. Default: 1

Read Example: SYST:BEEP:KEYB?

Response: 1

Set Example: SYST:BEEP:KEYB 1

Turns the keyboard beep function on or off.

SYST:CODE:LANG?

Read the language set option: 1: European; 2: Russian; 3: Asian. The available languages are dependent upon which version of the product is supplied. The version is dependent upon the final destination and configuration.

- European: ENGLISH (default), FRENch, SPANish, ITALian, GERMan
- Russian: RUSSian (default), ENGLISH
- Asian: ENGLISH (default), CHINese, JAPANese

Example: SYST:CODE:LANG?

Response: 3

SYST:CODE:VERS?

Read the main code version

Example: SYST:CODE:VERS?

Response: 1.10

Provides the user with the version of the main processor code.

SYST:COMM:SER:BAUD[?] [<baud>]

Read or set serial interface baud rate where “baud” is a standard baud rate value. Range baud = {1200, 2400, 4800, 9600, 19200, and 38400}; Default: 9600

Read Example: SYST:COMM:SER:BAUD?

Response: 2400

Set Example: SYST:COMM:SER:BAUD 9600

SYST:COMM:SER:LIN[?] [n]

Set serial interface linefeed enable, where “n” is a value 1 or 0. [0] = LF OFF, [1] = LF ON; Default: 1 (OFF)

Read Example: SYST:COMM:SER:LIN?

Response: 0

Set Example: SYST:COMM:SER:LIN 1

This command enables or disables line feed.

SYST:CONF:MOD?

Read the presence of the –P module; [0] if no –P sensor module, [1] if –P sensor card is installed

Example: SYST:CONF:MOD?

Response: 1

If the –P sensor module is installed, the instrument is a –P Model.

SYST:DATE[?] [<year>,<month>,<day>] (-P model only)



NOTE: This command is conditionally protected and requires a password to set it.

Read or set the System Date Setting using numbers separated by commas (yyyy,mm,dd). Default: <Blank>

Read Example: SYST:DATE?

Response: 2007,05,24

Set Example: SYST:DATE 2007,05,24

SYST:DEC:FORM[?] [n]

Read or set the decimal format, where “n” is period [0], comma [1]. Default: 0 (Period)

Read Example: SYST:DEC:FORM?

Response: 0

Set Example: SYST:DEC:FORM 1

SYST:ERR?

Read the most resent error from the error queue

Example: SYST:ERR?

Response: command protected

This command response reports the errors in the error queue.

SYST:KLOC[?] [n]



NOTE: This command is unconditionally protected and requires a password to set it.

Read or set the keypad lockout; [0] = unlock, and [1] = lock. Default: 0 (Unlock)

Read Example: SYST:KLOCK?

Response: 1

Set Example: SYST:KLOC 1

This command locks or unlocks the system keypad providing control only through the serial interface (RS-232 port) or the keypad.

SYST:LANG <lang>

Set the display language. The available languages are dependent upon which version of the product is supplied. The version is dependent upon the final destination and configuration.

European: ENGLISH (default), FRENch, SPANish, ITALian, GERMan

- Russian: RUSSian (default), ENGLISH
- Asian: ENGLis (default), CHINese, JAPANese
- Example: SYST:LANG SPAN

SYST:LANG:CAT?

Read the available display languages. The available languages are dependent upon which version of the product is supplied. The version is dependent upon the final destination and configuration.

- European: ENGLISH (default), FRENch, SPANish, ITALian, GERMan
- Russian: RUSSian (default), ENGLISH
- Asian: ENGLISH (default), CHINese, JAPANese

Example European: SYST:LANG:CAT?

Response: "ENGL","FREN","SPAN","ITAL","GERM"

Example Russian: SYST:LANG:CAT?

Response: "RUSS","ENGL"

Example Asian: SYST:LANG:CAT?

Response: "ENGL","JAP","CHIN"

SYST:PASS:CDIS

Disable access to password protected setting commands

Example: SYST:PASS:CDIS

This command has no response.

This command disables the system password protection.

SYST:PASS:CEN [n]

Enable access to password protected setting commands, where "n" is a four digit password.

Range = {0000 – 9999}; Default: 1234

Example: SYST:PASS:CEN 1234

This command has no response.

This command enables the system password. This password needs to be enabled in order to use the conditionally protected commands. When the power of the instrument is cycled, system password protection is disabled.

SYST:PASS:CEN:STAT?

Read the access state of password protected setting commands.

Example: SYST:PASS:CEN:STAT?

Response: 0

This command reports the current status of the system password.

SYST:PASS:NEW <n>|DEF



NOTE: This command is unconditionally protected, which requires a password to set it.

Set the password, where “n” is the new four digit password. Range = {0000 – 9999}; Default: 1234

Example: SYST:PASS:NEW 1234

This command has no response.

This command allows the user to set the system password.

SYST:PASS:PROT[?] [0|1]

Read or set password protection level., [0] = low, [1] = high

Read Example: SYST:PASS:PROT?

Response: 0

Set Example: SYST:PASS:PROT 1

SYST:TIME[?] [<hh,mm,ss>] (-P model only)



NOTE: This command is conditionally protected and requires a password to set it.

Read or set the System Time <hh,mm,ss> (24 hr time only)

Range: hh = {0 – 23}

 mm = {0 – 59}

 ss = {0 – 59}

Default: Current Time – American Fork, Utah, USA

Read Example: SYST:TIME?

914X Field Metrology Wells

Serial Commands - Alphabetic Listing

Response: 23,51,05

Set Example: SYST:TIME 14,15,05

UNIT:TEMP[?] [n]

Read or set the display temperature units, where “n” is a character “C” or “F”. Default: C

Read Example: UNIT:TEMP?

Response: C

Depending on instruments setting, a C (Celsius) or F (Fahrenheit) is returned.

Set Example: UNIT:TEMP F

7 Calibration of your Field Metrology Well

7.1 General



Note: For assistance with the process or any questions regarding the calibration of the Field Metrology Well, contact an Authorized Service Center.

This procedure is to be considered a general guideline. Each laboratory should write their own procedure based on their equipment and their quality program. Each procedure should be accompanied by an uncertainty analysis also based on the laboratory's equipment and environment.

7.2 Terminology

If the optional process version (-P model) was purchased, the Field Metrology Well actually consists of two separate instruments combined. When calibrating the Field Metrology Well, two separate calibrations will be conducted. For convenience in terminology, the optional process version (-P model) is referred to as the Readout. The dry-block calibrator is referred to as the Heat Source. The Readout and Heat Source combined make up the Field Metrology Well.

The Axial Uniformity is referred to as the Vertical Gradient.



Note: The Measuring and Test Equipment (M&TE) is referred to as the Unit Under Test (UUT).

7.3 Fundamentals

It is assumed that the technician is familiar with the Field Metrology Well User's Guide and Technical Manual.

The technician will need to be familiar with the User's Manual and operation of the voltage and current source.

It is assumed that the calibration will only be performed by trained personnel.

Readout calibration or Heat Source calibration may be optional depending on UUT configuration and customer requirement.

Environmental Conditions

Temperature range: $23^{\circ}\text{C} \pm 4^{\circ}\text{C}$

Ambient relative humidity: below 60%

Calibration Equipment

Table 9 Test equipment specifications

CLASSIFICATION	MINIMUM USE SPECIFICATIONS
Test Insert (Sleeve)	One hole accepts 1/4-inch diameter PRT, one hole accepts 3/16-inch diameter PRT (Hart model numbers 9142-INSG, 9143-INSG, or 9144-INSG)
Primary Reference	
Readout	20 ppm
PRT	0.008°C @ 0°C
Secondary Reference	
Readout	20 ppm
PRT	Sensor length ≤ 5 mm
External Reference	
Four-Wire Resistors	See Table 10
Voltage/Current Source	Voltage: ± 6 ppm + 0.6 μV Amperage: ± 40 ppm + 80 nA
Ice Point	25°C, Stability: ± 0.02°C
Readout	Accuracy: 0.0025°C
Probe	0.02°C @ 25°C
Thermocouples	0.025°C @ 25°C Type E characterized wire @ 25°C

Table 10 Standard resistor specifications

Resistance (Ω)	U _{S1} (k=1)		U _{S2} (k=1)		U _T (k=1)	U _T (k=2)
	Reference Resistor Uncertainty (ppm)	Reference Resistor Uncertainty (Ω)	TCR Uncertainty (ppm)	TCR Uncertainty (Ω)	Total Uncertainty (Ω)	
0	--	0.000040	--	--	0.00004	0.00008
25	1.80	0.000045	0.3	0.0000075	0.000045	0.00009
100	2.00	0.00020	0.3	0.00003	0.000205	0.00041
200	2.65	0.00053	0.3	0.00006	0.00055	0.0011
400	2.65	0.00106	0.3	0.00012	0.0011	0.0022

914x Field Metrology Well Readout Calibration

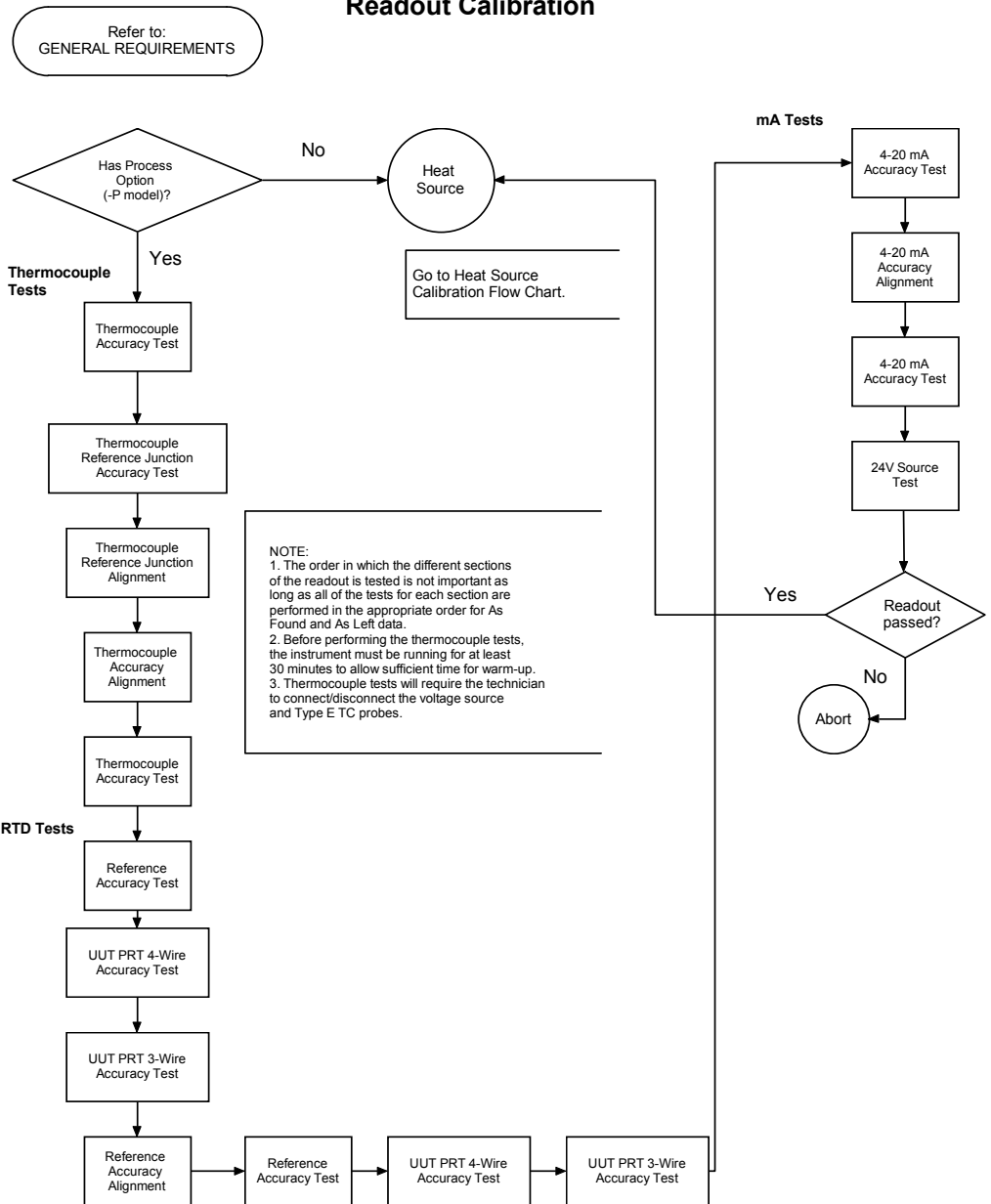

Figure 18 Readout calibration flow chart

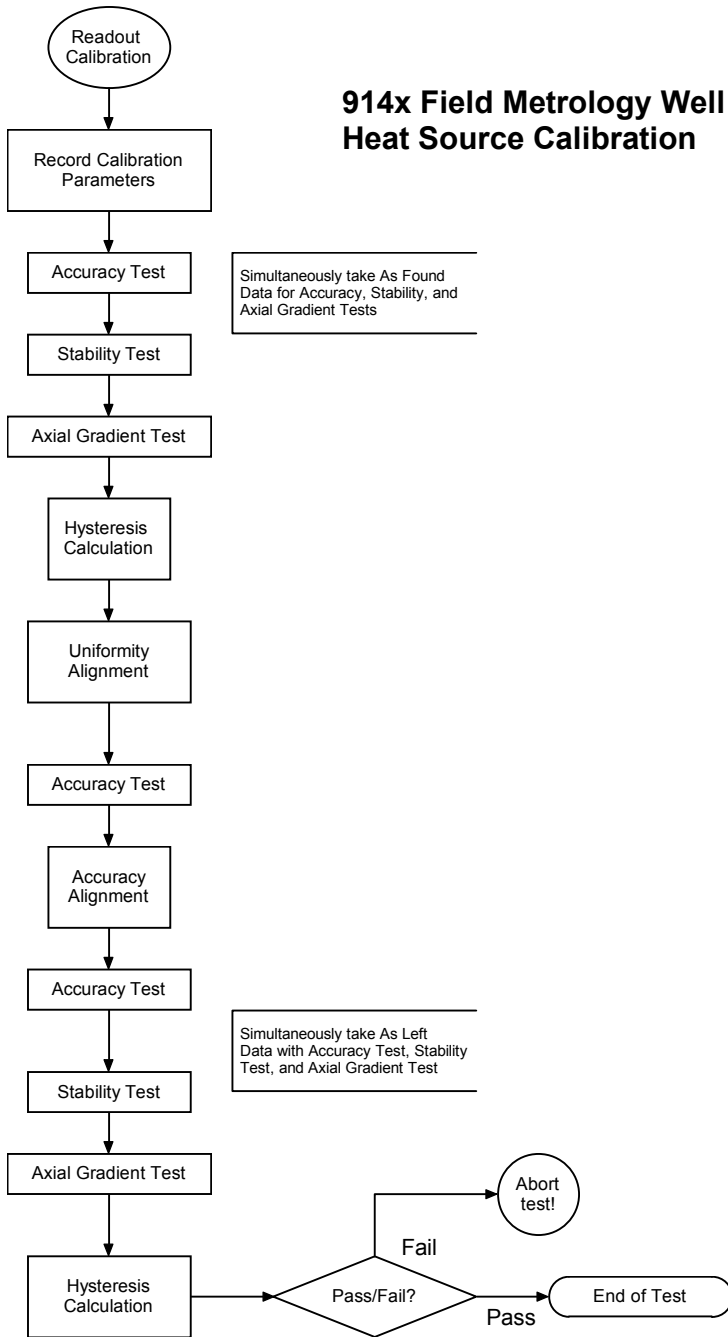

Figure 19 Heat source calibration flow chart

7.4 Procedure

7.4.1 Readout Calibration/Tests



Notes:

1. Before performing the thermocouple tests, the instrument must be running for at least 30 minutes to allow sufficient time for warm-up.

The thermocouple readout and block temperature should be allowed to warm up for 30min before calibrating. Set the heat source to control at the following temperatures:

9142: 25° C

9143: 33° C

9144: 50° C

This will ensure that the cold junction reference circuit has stabilized.

2. Thermocouple tests will require the technician to connect/disconnect the voltage source and Type E TC probes.

7.4.2 Readout Specifications

Refer to the Specifications Section for the readout specifications.

7.4.3 UUT Thermocouple Calibration

Table 11 indicates the order of the tests to be performed for the UUT thermocouple.

Table 11 Thermocouple Testing Process

#	Test Name	Nominal(s) mV	Notes
1	Thermocouple Accuracy Test	-10, 0, 50, 100	As Found/Alignment data
2	Thermocouple Reference Junction Accuracy Test	25°C	As Found/Alignment data
3	Thermocouple Reference Junction Alignment	-	Calculate reference junction offset using Alignment data
4	Thermocouple Accuracy Alignment	-	Calculate offsets using Alignment data
5	Thermocouple Reference Junction Accuracy Test	25°C	As Left data
6	Thermocouple Accuracy Test	-10, 0, 50, 100	As Left data

7.4.4 Thermocouple Accuracy Test

The Thermocouple Accuracy Test is used to collect As Found, Alignment, and As Left data.

1. Connect the voltage source.
2. Turn on the TC reference in the UUT
3. Set the instrument conversion type for the UUT thermocouple input to mV.
4. Turn the voltage on in the voltage source to -10 mV
5. Let the readout stabilize for a minimum of 20 sec.

6. Take a minimum of 40 samples.
7. Turn the voltage on in the voltage source to 0mv
8. Let the readout stabilize for a minimum of 20 sec.
9. Take a minimum of 40 samples.
10. Turn the voltage on in the voltage source to 50mv
11. Let the readout stabilize for a minimum of 20 sec
12. Take a minimum of 40 samples.
13. Turn the voltage on in the voltage source to 100mv
14. Let the readout stabilize for a minimum of 20 sec
15. Take a minimum of 40 samples.
16. Calculate the average of the measurements taken.
17. Record the data as appropriate for the type of calibration or step in the process.

7.4.5 Thermocouple Reference Junction Accuracy Test

The Thermocouple Cold Junction Accuracy Test is used to collect As Found, Alignment, and As Left data.



Note: The Thermocouple Reference Junction Accuracy Test requires the use of a Type E thermocouple. This thermocouple must be placed in a heat source and controlled at a constant 25°C throughout the duration of the test.

All Thermocouple Reference Junction Accuracy Tests are to be performed in °C.

1. Connect the Type E thermocouple to the thermocouple UUT connector on the instrument.
2. Set the instrument to take UUT measurements from the thermocouple input.
3. Set the instrument conversion type for the UUT thermocouple input to TC-E.
4. Allow the instrument to soak for 180 seconds.
5. Take temperature measurements from the UUT thermocouple input at a 2 second interval for a minimum of 40 samples.
6. Calculate the average of the measurements taken. Record these results.
7. Calculate the error using the formula indicated below. Record this result.

$$\text{error} = \text{average} - \text{nominal}$$

8. Compare the error with the spec to determine the status. Record the result.

7.4.6 Thermocouple Accuracy Alignment

The Thermocouple Accuracy Alignment process calculates new offsets to be programmed into the instrument for the UUT thermocouple input to correct for measured errors at specific points over the voltage range of the input.

1. Locate the results of the Thermocouple Accuracy Tests.

2. Using the calculated errors and the previous (current) offset values, calculate the new offset values for each thermocouple accuracy parameter using the formulas below:

$$TCC0_{new} = TCC0_{previous} - error_{0mV}$$

$$TCC100_{new} = TCC100_{previous} + (0.5 \times error_{0mV}) - (1.0 \times error_{50mV}) - (0.5 \times error_{100mV})$$

3. Enter the new offset values into the instrument.
4. Allow the instrument to soak for 20 seconds after entering the new offset values before taking any measurements.
5. Take As Left data using the steps outlined in the Thermocouple Accuracy Test.

7.4.7 Thermocouple Reference Junction Accuracy Alignment

The Thermocouple Reference Junction Accuracy Alignment process calculates a new offset to be programmed into the instrument for the UUT thermocouple reference junction to correct for the measured error at 25°C.



NOTE: This alignment relies on the results of the thermocouple accuracy test. Therefore, the thermocouple accuracy test **MUST** be performed before this alignment!

1. Locate the results of the Thermocouple Reference Junction Accuracy Test and the Thermocouple Accuracy Test at 0mV.
2. Using the calculated errors and the previous (current) offset value, calculate the new offset value for the thermocouple reference junction accuracy parameter using the formula below:

$$TCCRJ_{new} = TCCRJ_{previous} - error_{25^{\circ}C} + (17 \times error_{0mV})$$

3. Enter the new offset values into the instrument.
4. Allow the instrument to soak for 20 seconds before taking any measurements.
5. Take As Left data using the steps outlined in the Thermocouple Reference Junction Accuracy Test.

Table 12 Reference Probe and UUT PRT Input Process

#	Test Name	Nominal(s) Ohms	Notes
1	Reference Accuracy Test	0, 25, 100, 200, 400	As Found/Alignment data – Reference input
2	UUT PRT 4-wire Accuracy Test	100	As Found data – UUT input
3	UUT PRT 3-wire Accuracy Test	100	As Found data – UUT input
4	Reference Accuracy Alignment	-	Calculate offsets using Alignment data
5	Reference Accuracy Test	0, 25, 100, 200, 400	As Left data – Reference input
6	UUT PRT 4-wire Accuracy Test	100	As Left data – UUT input
7	UUT PRT 3-wire Accuracy Test	100	As Left data – UUT input

7.4.8 Reference Accuracy Test

The Reference Accuracy Test is used to collect As Found, Alignment, and As Left data. All Reference Accuracy Tests are to be performed in Ohms.

1. Turn on the PRT reference input in the instrument
2. Set the instrument conversion type for the UUT PRT input to resistance.
3. Connect the short (0 Ohm).
4. Let readout stabilize for 70 seconds.
5. Take resistance measurements from the reference probe input at a 2 second interval. Take a minimum of 40 samples.
6. Connect the 25 Ohm resistor.
7. Let readout stabilize for 70 seconds.
8. Take resistance measurements from the reference probe input at a 2 second interval. Take a minimum of 40 samples.
9. Connect the 100 Ohm resistor.
10. Let readout stabilize for 70 seconds.
11. Take resistance measurements from the reference probe input at a 2 second interval. Take a minimum of 40 samples.
12. Connect the 200 Ohm resistor.
13. Let readout stabilize for 70 seconds.
14. Take resistance measurements from the reference probe input at a 2 second interval. Take a minimum of 40 samples.
15. Connect the 400 Ohm resistor.
16. Let readout stabilize for 70 seconds.
17. Take resistance measurements from the reference probe input at a 2 second interval. Take a minimum of 40 samples.
18. Calculate the average of the measurements taken. Record these results.
19. Calculate the error using the formula indicated below where actual is the calibrated resistance value of the standard resistor. Record this result.

$$\text{error} = \text{average} - \text{actual}$$

20. Compare the error with the spec to determine the status. Record the result.

7.4.9 UUT PRT 4-wire Test

The UUT PRT 4-wire Test is used to collect As Found and As Left data. All UUT PRT 4-wire Test are to be performed in Ohms.

1. Connect the 100 Ohm resistor in the 4-wire UUT configuration.
2. Set the instrument to take UUT measurements from the PRT input.
3. Set the instrument to 4-wire mode for the UUT PRT input.
4. Set the instrument conversion type for the UUT PRT input to resistance.
5. Allow the instrument to soak for 20 seconds.
6. Take resistance measurements from the UUT PRT input at a 2 second interval. Take a minimum of 40 samples.
7. Calculate the average of the measurements taken. Record these results.

8. Calculate the error using the formula indicated below where actual is the calibrated resistance value of the standard resistor. Record this result.

$$error = average - actual$$

9. Compare the error with the spec to determine the status. Record the result.

7.4.10 UUT PRT 3-wire Test

The UUT PRT 3-wire Test is used to collect As Found and As Left data. All UUT PRT 3-wire Test are to be performed in Ohms.

1. Connect the 100 Ohm resistor in the 3-wire UUT configuration.
2. Set the instrument to take UUT measurements from the PRT input.
3. Set the instrument to 3-wire mode for the UUT PRT input.
4. Set the instrument conversion type for the UUT PRT input to resistance.
5. Allow the instrument to soak for 20 seconds.
6. Take resistance measurements from the UUT PRT input at a 2 second interval. Take a minimum of 40 samples.
7. Calculate the average of the measurements taken. Record these results.
8. Calculate the error using the formula indicated below where actual is the calibrated resistance value of the standard resistor. Record this result.

$$error = average - actual$$

9. Compare the error with the spec to determine the status. Record the result.

7.4.11 Reference Accuracy Alignment

The Reference Accuracy Alignment process calculates new offsets to be programmed into the instrument for the reference probe input to correct for measured errors at specific points over the resistance range of the input.

1. Locate the results of the Reference Accuracy Tests.
2. Using the calculated errors and the previous (current) offset values, calculate the new offset values for each reference accuracy parameter using the formulas below:

$$REF1C0_{new} = REF1C0_{previous} - error_{0\ ohms}$$

$$REF1C100_{new} = REF1C100_{previous} + (0.625 \times error_{0\ ohms}) - (0.5 \times error_{100\ ohms}) - (0.125 \times error_{400\ ohms})$$

3. Enter the new offset values into the instrument.
4. Allow the instrument to soak/equilibrate for 70 seconds before taking any measurements.
5. Take As Left data using the Reference Accuracy Test, UUT PRT 4-wire Accuracy Test and UUT 3-wire Accuracy Tests.

7.4.12 UUT 4-20mA Input Calibration

Table 13 outlines the basic sequence of tests to be performed for the UUT 4-20mA input of the -P module.

Table 13 UUT 4-20 mA Calibration Steps

#	Test Name	Nominal(s) mA	Notes
1	4-20 mA Accuracy Test	0, 4, 12, 20, 22	As Found/Alignment data
2	4-20 mA Accuracy Alignment	-	Calculate offsets using Alignment data
3	4-20 mA Accuracy Test	0, 4, 12, 20, 22	As Left data
4	24 V Source Test	24 volts	Functional test

7.4.13 4-20mA Accuracy Test

The 4-20mA Accuracy Test is used to collect As Found, Alignment, and As Left data. All 4-20mA Accuracy Tests are to be performed in mA.

1. Connect the current source to the 4-20mA UUT connector on the instrument.
2. Set the instrument to take UUT measurements from the 4-20mA input.
3. Set the instrument's UUT mA input LOOP POWER setting to DISABLED.
4. Set the current source to supply 0mA.
5. Let the readout stabilize for 20 seconds.
6. Take mA measurements from the UUT mA input at a 2 second interval. Take a minimum of 40 samples.
7. Set the current source to supply 4mA.
8. Let the read out stabilize for 20 seconds.
9. Take mA measurements from the UUT mA input at a 2 second interval. Take a minimum of 40 samples.
10. Set the current source to supply 12mA.
11. Let the readout stabilize for 20 seconds.
12. Take mA measurements from the UUT mA input at a 2 second interval. Take a minimum of 40 samples.
13. Set the current source to supply 20mA
14. Let the readout stabilize for 20 seconds.
15. Take mA measurements from the UUT mA input at a 2 second interval. Take a minimum of 40 samples.
16. Set the current source to supply 22mA
17. Let the readout stabilize for 20 seconds.
18. Take mA measurements from the UUT mA input at a 2 second interval. Take a minimum of 40 samples.
19. Calculate the average of the measurements taken. Record these results.
20. Calculate the error using the formula indicated below. Record this result.

$$\text{error} = \text{average} - \text{nominal}$$

21. Compare the error with the spec to determine the status. Record the result.

7.4.14 24V Source Test

The 24V Source Test is used to collect As Found and As Left data. All 24V Source Tests are to be performed in mA.

1. Connect the voltage source to the 4-20mA UUT connector on the instrument.
2. Set the instrument to take UUT measurements from the 4-20mA input.
3. Set the instrument's UUT mA input LOOP POWER setting to ENABLE 24V.
4. Connect the 1200 ohm resistor to the voltage source.
5. Set the voltage source to supply 24 volts.
6. Allow the instrument to soak for 30 seconds.
7. Take voltage measurements from the UUT 4-20mA input at a 1 second interval.
8. Calculate the average of the measurements taken. Record these results.
9. Compare the average with the spec (see Section 2.1 Specifications on page 11) to determine the status. Record the result.

7.4.15 4-20mA Accuracy Alignment

The 4-20mA Accuracy Alignment process calculates new offsets to be programmed into the instrument for the UUT 4-20mA input to correct for measured errors at specific points over the current range of the input.

1. Locate the results of the 4-20mA Accuracy Tests.
2. Using the calculated errors and the previous (current) offset values, calculate the new offset values for each 4-20mA accuracy parameter using the formulas below:

$$MAC4_{new} = MAC4_{previous} - error_{4mA}$$

$$MAC22_{new} = MAC22_{previous} - (1.0 \times error_{12mA}) - (0.5 \times error_{22mA})$$

3. Enter the new offset values into the instrument.
4. Allow the instrument to soak for 20 seconds after entering the new offset values before taking any measurements.
5. Take As Left data using the 4-20 mA Accuracy Test and the 24V Source Test.

7.5 Heat Source Calibration/Test

The heat source portion of the 914x series instruments is tested and calibrated using the tests outlined below in the order indicated for each model. Details on performing each of the tests can be found in the subsequent sections.

The following table outlines the basic sequence of tests to be performed for the heat source portion of the instrument. Many tests that use the same nominal set-points may be performed sequentially as noted.

914X Field Metrology Wells

Heat Source Calibration/Test

Table 14 Heat Source Calibration/Test Sequence

#	Test Name	Nominal(s) °C			Notes
		9142	9143	9144	
1	Accuracy Test	-25, 0, 50, 100, 150	33, 100, 200, 275, 350	50, 200, 420, 550, 660	As Found data - Perform twice at each point (up-down or down-up) except at vertex
2	Stability Test	-25, 150	33, 200, 350	50, 420, 660	As Found data - can be performed with Accuracy Tests at same nominal set-points
3	Axial Gradient Test	-25, 50, 100, 150	33, 100, 200, 350	50, 200, 420, 550, 660	As Found/Alignment data – use data for initial uniformity alignment - can be performed with Accuracy Tests at same nominal set-points
4	Hysteresis Calculation	-25, 0, 50, 100, 150	33, 100, 200, 275, 350	50, 200, 420, 550, 660	As Found data – use two As Found Accuracy Test results, except at vertex
5	Uniformity Alignment	-25, 50, 100, 150	100, 200, 350	50, 200, 420, 550, 660	Calculate offset using As Found/ Alignment data
6	Axial Gradient Test	-25, 50, 100, 150	33, 100, 200, 350	50, 200, 420, 550, 660	Make sure Uniformity Alignment is successful – repeat steps 6–7 if necessary (max 3 times)
7	Accuracy Test	-25, 0, 50, 100, 150	33, 100, 200, 275, 350	50, 200, 420, 550, 660	Alignment data – collect data at each set-point for Accuracy Alignment calculations (cannot use As Found data)
8	Accuracy Alignment	—	—	—	Calculate offsets using Alignment data
9	Accuracy Test	-25, 0, 50, 100, 150	33, 100, 200, 275, 350	50, 200, 420, 550, 660	As Left data - Perform twice at each point (up-down or down-up) except at vertex
10	Stability Test	-25, 150	33, 200, 350	50, 420, 660	As Left data – can be performed with Accuracy Tests at same nominal set-points
11	Axial Gradient Test	-25, 50, 100, 150	33, 100, 200, 350	50, 200, 420, 550, 660	As Left data - can be performed with Accuracy Tests at same nominal set-points
12	Hysteresis Calculation	-25, 0, 50, 100, 150	33, 100, 200, 275, 350	50, 200, 420, 550, 660	As Left data – use two As Left Accuracy Test results, except at vertex

Table 15 Axial Gradient Limits

Model	Set-point (°C)	Soak (min)	Samples	Limit (± °C)
9142	-25	30	40	0.050
	50			
	100			
	150			
9143	33	30	40	0.040
	100			0.080
	200			0.100
	350			0.200

Model	Set-point (°C)	Soak (min)	Samples	Limit (± °C)
9144	50	30	40	0.050
	200			0.170
	420			0.350
	550			0.430
	660			0.500

7.5.1 Axial Gradient Test

The Axial Gradient Test is used to collect As Found, Alignment, and As Left data. For soak times, number of measurements, specs, and other settings refer to Table 16.

The calibration insert (Hart Model 914x-INSG) must be oriented as indicated in Figure 20. The Axial Gradient Test requires the use of one reference standard, ¼ “ PRT, and a secondary PRT with a sensor length 5 mm or less. The reference standard is inserted the full-depth of the well in the position indicated in Figure 20. The secondary PRT is inserted the full-depth of the well in the position indicated in Figure 20.

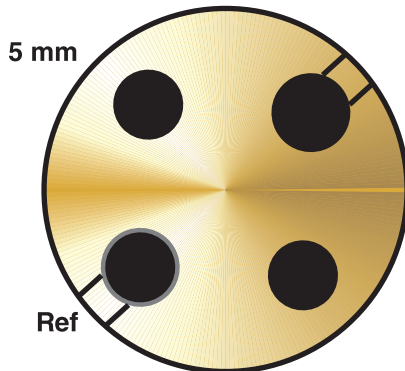

Figure 20 PRT and insert orientation during heat source calibration.

1. Insert the reference PRT the full-depth of the appropriate well.
2. Insert the 5 mm PRT the full –depth (0 mm) as indicated in Figure 20.
3. Set UUT to lowest set-point according to Table 15.
4. Allow the UUT to stabilize – soak for 30 minutes.
5. Take readings for 2 minutes or a minimum of 40 samples.
6. Record data and average readings.
7. Move 5 mm PRT to 40 mm.
8. Wait for the UUT to stabilize – soak for 30 minutes.
9. Take readings for 2 minutes or a minimum of 40 samples.
10. Record data and average readings.
11. Calculate the gradient.

$$dt_n = t_{40mm} - t_{0mm}$$

12. Check that data is within limit stated in Table 15.

13. Set UUT to next set-point and repeat steps 4-12.

7.5.2 Accuracy Test

The Accuracy Test is used to collect As Found, Alignment, and As Left data. For soak times, number of measurements, specs, and other settings, refer to Table 16 on page 97.

The Accuracy Test requires the use of one reference standard – primary reference standard – which is inserted into a full-depth hole in the calibration insert. The reference standard should be oriented with the calibration insert as indicated.



Note: For cold UUTs, perform the Accuracy Tests start with the coldest nominal set-point first, performing the test at each subsequent nominal set-points up to the hottest, then repeat in reverse. For hot UUTs, start with the hottest nominal set-point first, down to the coldest nominal set-point, then repeat in reverse.

1. Set the heat source to the nominal temperature set-point and engage temperature control.
2. Monitor the instrument's stability indicator until it reports the heat source is stable.
3. Allow the instrument to soak at the set-point.
4. Take measurements from the primary reference standard at a 20 second interval.
5. Calculate the average of the measurements taken. Record the results.
6. Calculate the error using the formula indicated below. Record this result.

$$\text{error} = \text{average} - \text{nominal}$$

7. Compare the error with the spec in Table 16 on page 97 to determine the status. Record the result.

7.5.3 Stability Test

The Stability Test is used to collect As Found and As Left data. For soak times, number of measurements, specs, and other settings refer to Table 16 on page 97.

The Stability Test requires the use of one reference standard – primary reference standard – which is inserted into a full-depth hole in the calibration insert. The reference standard should be oriented with the calibration insert as indicated in Figure 20.



Note: Stability Tests may be performed simultaneously with an Accuracy Test that uses the same nominal set-point. In this case, the steps to set the set-point, wait for stability, and soak may be skipped so long as the soak time requirement has already been met.

1. Set the heat source to the nominal temperature set-point and engage temperature control.
2. Monitor the instrument's stability indicator until it reports the heat source is stable.
3. Allow the instrument to soak at the set-point.
4. Take measurements from the primary reference standard at a 20 second interval for the

duration of the test.

5. Calculate the 2σ (2x standard deviation) of the measurements taken. Record these results.
6. Compare the 2σ result with the 2σ specification in Table 16 to determine the pass/fail result. Record the result.

7.5.4 Hysteresis Calculation

The Hysteresis Calculation calculates the hysteresis between two Accuracy Tests performed at the same nominal temperature set-point to find the nominal set-point temperature with the largest difference.



Note: There are two Accuracy Tests for each nominal temperature set-point for As Found and As Left data sets with the exception of the vertex (hottest set-point when scanning up then down, coldest set-point when scanning down then up).

1. Locate the results of the two Accuracy Tests at each nominal set-point temperature in the same data set (As Found or As Left). Ensure that the data is from the same data set (As Found or As Left) and **NOT** mixed, one As Found and one As Left.
2. Calculate the magnitude of the difference between the two results for each nominal set-point temperature using the formula below. Record these results.

$$\text{difference}_n = |\text{average test } 1_n - \text{average test } 2_n|$$

3. Locate the data for the nominal set-point temperature with the largest difference.
4. Compare the difference with the published hysteresis specification (see Section 2.1 Specifications on page 11) to determine the status. Record these results.

Table 16 Heat Source As Found Data/As Left Data Specifications

Model	Set-Point	Soak Time	# Samples	Accuracy Spec (\pm °C)	Stability 2σ Limit (°C)
9142 (Descending Order)	-25	30 min	40	0.200	0.010
	0				
	50				
	100				
	150				
9143 (Ascending Order)	33	30 min	40	0.200	0.020
	100				0.020
	200				0.020
	275				0.025
	350				0.030

914X Field Metrology Wells

Heat Source Calibration/Test

Model	Set-Point	Soak Time	# Samples	Accuracy Spec (± °C)	Stability 2σ Limit (°C)
9144 (Ascending Order)	100	30 min	40	0.350	0.030
	200			0.350	0.030
	350			0.350	0.040
	550			0.420	0.050
	660			0.500	0.050

7.5.5 Uniformity Alignment

The Uniformity Alignment process calculates a new setting for the uniformity parameter to be programmed into the instrument to correct for temperature differences between the top and bottom zones of the heat source block.



Note: The Uniformity Alignment process must be completed before any data may be collected using Accuracy Tests to perform the Accuracy Alignment process.

1. Locate the results of the Uniformity Tests.
2. Calculate the new value for the uniformity parameter using the previous (current) parameter value and the results of the Uniformity Tests using the formula below specific to each model:

9142 – GRAD 1, GRAD 2, and GRAD 3 Only

$$GRAD\ 1_{new} = GRAD\ 1_{old} + dG1$$

$$GRAD\ 2_{new} = GRAD\ 2_{old} + dG2$$

$$GRAD\ 3_{new} = GRAD\ 3_{old} + dG3$$

where:

$$dG1 = 1.55 \times dt(-25)$$

$$dG2 = -0.385 \times dt(50) - 1.10 \times dt(100)$$

$$dG3 = -0.360 \times dt(150)$$

9143 – GRAD 1 , GRAD 2, and GRAD 3 Only

$$GRAD\ 1_{new} = GRAD\ 1_{old} + dG1$$

$$GRAD\ 2_{new} = GRAD\ 2_{old} + dG2$$

$$GRAD\ 3_{new} = GRAD\ 3_{old} + dG3$$

where:

$$dG1 = -4.2 \times dt(100)$$

$$dG2 = -1.75 \times dt(200)$$

$$dG3 = -0.75 \times dt(350)$$

9144 – GRAD 1, GRAD 2, GRAD 3, GRAD 4 and GRAD 5

$$GRAD\ 1_{new} = GRAD\ 1_{old} + dG1$$

$$GRAD\ 2_{new} = GRAD\ 2_{old} + dG2$$

$$GRAD\ 3_{new} = GRAD\ 3_{old} + dG3$$

$$GRAD\ 4_{new} = GRAD\ 4_{old} + dG4$$

$$GRAD\ 5_{new} = GRAD\ 5_{old} + dG5$$

where:

$$dG1 = -1.900 \times dt(50)$$

$$dG2 = -0.360 \times dt(200)$$

$$dG3 = -0.215 \times dt(420)$$

$$dG4 = -0.165 \times dt(550)$$

$$dG5 = -0.130 \times dt(660)$$

1. Enter the new parameter value into the instrument.
2. Allow the instrument to soak/equilibrate after entering the new parameter value before taking any measurements.

7.5.6 Accuracy Alignment

The Accuracy Alignment process calculates new offsets to be programmed into the instrument to correct for temperature errors over the entire range of the heat source.



Note: The Accuracy Alignment process must be performed using data that was collected from Accuracy Tests after the Uniformity Alignment process has been completed successfully.

1. Locate the results of the Accuracy Tests that were performed after the Uniformity Alignment process was completed. Data at all set-points is used.
2. Calculate the temperature bias offset at each set-point and update the parameters (refer to Table 17).

914X Field Metrology Wells

Heat Source Calibration/Test

Table 17 Accuracy alignment parameters

Model	Nominal Align Set-point (°C)	Parameter	
		Serial Command	Display
9142	-25	SOUR:SENS:CAL:PAR1	TEMP 1
	50	SOUR:SENS:CAL:PAR2	TEMP 2
	150	SOUR:SENS:CAL:PAR3	TEMP 3
9143	35	SOUR:SENS:CAL:PAR1	TEMP 1
	200	SOUR:SENS:CAL:PAR2	TEMP 2
	350	SOUR:SENS:CAL:PAR3	TEMP 3
9144	100	SOUR:SENS:CAL:PAR1	TEMP 1
	425	SOUR:SENS:CAL:PAR2	TEMP 2
	660	SOUR:SENS:CAL:PAR3	TEMP 3



Note: To calculate the bias offset, simply subtract the reference temperature from the set-point and enter the difference, i.e. set-point = 30°C, actual temperature = 30.6°C.

$$T_{REF} - T_{SPT} = \text{Offset}$$

Thus, 30°C – 30.6°C = -0.6°C offset

3. After updating the calibration parameters with the new offset values, take As Left data using the steps 9 through 12 of Table 14 page 94.



Note: The calibration parameters are accessed from the front panel by selecting MENU\SYSTEM MENU\CALIB. Enter the correct password to access the parameters. The parameters may also be accessed through the RS232 interface.

8 Troubleshooting

This section contains information on troubleshooting.

In the event that the Field Metrology Well appears to function abnormally, this section may help to find and solve the problem. Several possible problem conditions are described along with likely causes and solutions. If a problem arises, please read this section carefully and attempt to understand and solve the problem. If the Field Metrology Well seems faulty or the problem cannot otherwise be solved, contact an Authorized Service Center for assistance. Be sure to have the instrument model number, serial number, and voltage available.

Table 18 *Troubleshooting, problems, causes and solutions*

Problem	Causes and Solutions
The instrument does not power up	<p>Check the fuses. If a fuse blows, it may be due to a power surge or a component failure. Replace the fuse once. DO NOT replace the fuse with one of a higher current rating. Always replace the fuse with one of the same rating, voltage, and type. If the fuse blows a second time, it is likely caused by failure of a component part.</p> <p>Power Cord. Check that the power cord is plugged in and connected to the instrument.</p> <p>AC Mains Power. Insure the circuit supplying power to the instrument is on.</p>
The display is blank The instrument powers up: 9142 – fan turns on, 9143 and 9144 – the power relay clicks, but the display remains blank	<p>Contrast. Check the screen contrast. Toggle the down arrow key to see if the screen contrast lightens.</p> <p>If the contrast is not the issue, contact an Authorized Customer Service Center.</p>
The instrument heats slowly	Scan Rate. Check the Scan Rate settings. The Scan Rate may be set with too low a rate per minute for the current application.
If the display shows an abnormal temperature	The sensor is disconnected, open or shorted. Please contact a Service Center for further instructions.
If the display shows cutout	<p>Cutout. If the Metrology Well exceeds the temperature set in the soft cutout menu, or if it exceeds the maximum operating temperature of the instrument, a cutout condition occurs. If this happens, the unit enters cutout mode and will not actively heat or cool until the user issues the command to clear the cutout or resets the instrument using the SET PT. key to clear the cutout mode and activate the instrument.</p> <p>Reset. The software cutout may need to be adjusted for the application. Check and adjust the cutout setting by entering CUTOUT menu: MENU TEMPSETUP CUTOUT.</p>
Temperature readout is not the actual temperature of the well OR Incorrect temperature reading	<p>Operating Parameters. Insure that all operating parameters for the Metrology Well, reference thermometer, and/or probe parameters match the Report of Certification that was sent with the instrument and/or probe.</p> <p>Electrical Interference. Look for sources of electrical interference, such as motors, welders, generating equipment nearby, or ground loops. Try shielding wires, removing ground loops, or changing location.</p>
(9142) Probes stuck in the well at low temperatures	Moisture. If the Metrology Well has been used at low temperatures for extended periods of time, moisture may have built up in the well forming ice at low temperatures. Set the temperature high enough to melt ice to remove probes. Set the set-point to +100°C and allow the moisture to evaporate out of the system.

914X Field Metrology Wells

Problem	Causes and Solutions
(9142) Insert stuck in well	<p>If maintenance has not been performed on the insert as described in the Maintenance Section and the insert cleaned periodically, hard water build-up on the insert may cause it to stick.</p> <p>Have the unit in a cold environment – less 21°C. Set the unit to 100°C. While the unit is heating, at approximately 50°C to 70°C, pull on the insert.</p> <p>If this does not remove the insert, contact an Authorized Service Center.</p>
-P Model Only	
The Ref Probe shows an abnormal temperature or “.....”	<p>Check the Probe type setting in the Reference Probe Setup menu is correct. Check all associated parameters. Check that the 4 probe wires are connected and not shorted inside of the connector.</p>
RTD shows an abnormal temperature or “.....”	<p>Check the RTD type setting in the RTD Setup menu is correct. Check all associated parameters for the current RTD type. Check that the number of wires setting is correct for the number wires actually used. If using a 2-wire RTD, make sure that the unused RTD inputs are shorted to the used RTD inputs as shown in the manual. Using a 3-wire setting on a 4-wire probe can cause errors of 0.01 to 0.1 ohms. Check that the probe wires are not shorted or open.</p>
Thermocouple shows an abnormal temperature or “.....”	<p>Check the TC type setting in the TC Setup menu is correct for the TC used. Make sure the TC wires are not loose in the connector or shorted.</p>
mA reading does not read	<p>Check to see if the device being tested needs loop power, if so enable Loop Power in the mA Setup menu. Make sure the mA fuse is good. It is located on the front panel just under the RTD inputs.</p>
The Ref, RTD, TC, or mA Reading is abnormal or noisy	<p>Wrong Calibration Parameters. The problem may be that the wrong calibration parameters are loaded into the 914x. Check the parameters in the instrument against the parameters listed on the Report of Calibration for both the REF and UUT.</p> <p>Electrical Interference. Strong radio frequency radiation from sources such as radio transmitters, welders, and large electric motors may change the reading. Try moving the instrument to another location away from the source of interference.</p>
The current REF and UUT measurement will not display in the Main Menu	<p>Please contact an Authorized Customer Service Center for further instructions.</p>

9 Maintenance

The Field Metrology Well has been designed with the utmost care. Ease of operation and simplicity of maintenance have been a central theme in the product development. With proper care, the instrument should require very little maintenance. Avoid operating the instrument in an oily, wet, dirty, or dusty environment. Operating the instrument in a draft-free environment facilitates improved performance of the instrument.

- If the outside of the instrument becomes soiled, it may be wiped clean with a damp cloth and mild detergent. Do not use harsh chemicals on the surface which may damage the paint or plastic.
- It is important to keep the well of the calibrator clean and clear of any foreign matter. **DO NOT** use fluid to clean out the well.
- The instrument should be handled with care. Avoid knocking or dropping the calibrator.
- The removable inserts can become covered with dust and carbon material. If the buildup becomes too thick, it could cause the inserts to become jammed in the wells. Avoid this build up by periodically buffing the inserts clean.
- If an insert should be dropped, examine the insert for deformities before inserting it in the well. If there is any chance of jamming the insert in the well, file or grind off the protuberance.
- **DO NOT** allow the probe stems to drop into the well or harshly impact the well bottom. This type of action can cause a shock to the sensor.
- If a hazardous material is spilled on or inside the instrument, the user is responsible for taking the appropriate decontamination steps as outlined by the national safety council with respect to the material.
- If the mains supply cord becomes damaged, replace it with a cord of the appropriate gauge wire for the current of the instrument. If there are any questions, contact an Authorized Service Center for more information.
- Before using any cleaning or decontamination method, other than those recommended by Fluke's Hart Scientific Division, users should check with an Authorized Service Center to insure the proposed method will not damage the equipment.
- If the instrument is used in a manner not in accordance with the equipment design, the operation of the instrument may be impaired or safety hazards may arise.
- The over-temperature cutout should be checked every 6 months to see that it is working properly. In order to check the user selected cutout, follow the controller directions for setting the cutout. Set the instrument temperature higher than the cutout. Check to see if the display shows cutout and the temperature is decreasing.

9.1 Field Metrology Well Performance Analysis

For optimum performance and lowest possible uncertainty budgets, use the guidelines set forth below.

Accuracy Drift

The display temperature of the instrument will drift over time. This is due to a variety of factors affecting the temperature control PRT. Any PRT is subject to changes depending on how it is used and the environment it is used in. This is no different for any PRT in a calibration application. In addition, manufacturing variables in the sensing element itself can result in greater or lesser impact from use and environment. Oxidation and contamination from the sensor's environment will create changes requiring new calibration constants depending on the temperature range and normal operation of the instrument. Oxidation and contamination are generally not factors when Field Metrology Wells are used exclusively below 200°C. Oxidation can form in the body of the PRT platinum sensor wire in the range of 300 °C to 500 °C. Contamination is primarily a problem following prolonged use above 500°C. Additionally, vibration from handling or transportation will strain the delicate PRT element, changing its resistance. Some of this strain may come out by annealing at a slightly higher temperature than the instrument is typically used at. It is recommended to avoid unnecessary temperature cycling. Cycling the temperature up and down between minimum and maximum temperatures excessively may also cause strain on the PRT element.

Effects from control sensor drift may be avoided by using an external temperature reference. In the case that the calibration of the display value is required, a program of monitoring and recalibration must be implemented, just as with any calibration standard. Regularly check the accuracy of the Field Metrology Well with an adequate temperature reference and keep records as a part of your instrument maintenance routine. When the accuracy drifts to a point where it is no longer acceptable, then have the instrument recalibrated. Your records will provide data for determining a calibration interval appropriate for your history of use and accuracy requirements.

Stability

The stability specification of the Field Metrology Well was determined under laboratory conditions of steady ambient temperature and air flow. While this instrument has been designed to minimize ambient effects, they will still have some effect. For the best results, avoid quickly-changing ambient temperatures and drafty conditions.

Axial Uniformity

Field Metrology Well axial uniformity should be checked periodically. Use the process outlined in EA 10/13 or a similar process. If the axial uniformity has changed outside the limits set by the user's uncertainty budget, adjust the axial gradient as outlined in the Field Metrology Well Calibration section of the Field Metrology Well Technical Guide and recalibrate the Field Metrology Well.