

SafeCount™



Product Selection Guide

IS SAFECOUNT SUITABLE FOR YOUR BUILDING?

SafeCount has been designed to work in buildings and rooms of all sizes, even those with multiple entrances/exits. To make sure that SafeCount will work accurately in your building, here are the mounting requirements for the SafeCount sensor.

Please note, to maintain an accurate occupancy count, a SafeCount sensor needs to be installed at all doorways/entryways to the area being monitored. SafeCount sensors are typically ceiling mounted, although drop poles can be used if required.

SafeCount Sensor Mounting Requirements

For best performance, SafeCount sensors should be installed on the **non-door swing side** of the entryway. If this is not possible, the sensor can be moved out from the door so that the swing of the door is not directly underneath it, however, ensure this mounting position complies with the mounting table below.

Please note, when measuring the occupancy of a washroom, we always recommend mounting the sensor outside of the room

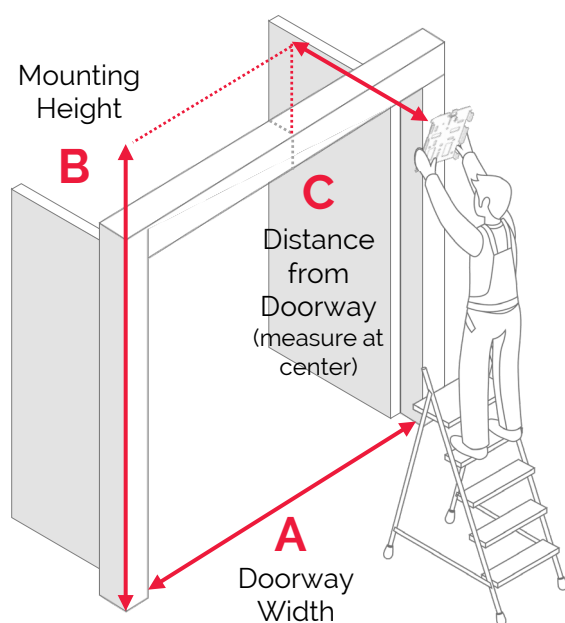

A	B	C
Doorway Width	Minimum Mounting Height (*)	Doorway to Bottom of Base Plate
Up to 195cm (76in)	250cm (98in)	45-59cm (18-23in)
195-230cm (76-91in)	275cm (108in)	51-72cm (20-28in)
230-265cm (91-105in)	300cm (118in)	64-84cm (25-33in)
265-335cm (105-133in)	350cm (138in)	76-110cm (30-43in)
335-410cm (133-161in)	400cm (157in)	89-135cm (35-53in)
(*) Max. mounting height: 450cm (177in)		

- 1. Measure the doorway width (A)** and look up the minimum mounting height required.
- 2. Measure the ceiling height (B)** in the center of the doorway and check it is greater than the minimum height required and is less than the maximum allowed of 450cm (177in).
 - a. Doorway too wide? SafeCount can still help you, however this requires technical assistance. Please contact Irisys directly.
 - b. Ceiling height too low? Consider mounting on other side of doorway or contact Irisys for technical assistance as multiple sensors could be used to cover your doorway.
 - c. Ceiling height too high? Consider using a drop pole from the ceiling or polearm from a nearby wall.
- 3. Lookup the sensor distance from doorway (C)** required and check that this area on the ceiling is clear and suitable for a sensor to be mounted to. This should be done centrally to the doorway, however the sensor can be moved forwards or backwards within the specified range.

WHAT EQUIPMENT IS REQUIRED?

Primary and Secondary SafeCount sensors. What's the difference?

There are two types of SafeCount sensors, Primary and Secondary.

- You only need **ONE** Primary sensor per occupancy area. We recommend installing the Primary sensor at the main (or busiest) entrance to the area.
- Secondary sensors are used for any other entrances to the area you are monitoring the occupancy of. Up to **TWENTY** Secondary sensors can be used with one Primary sensor.

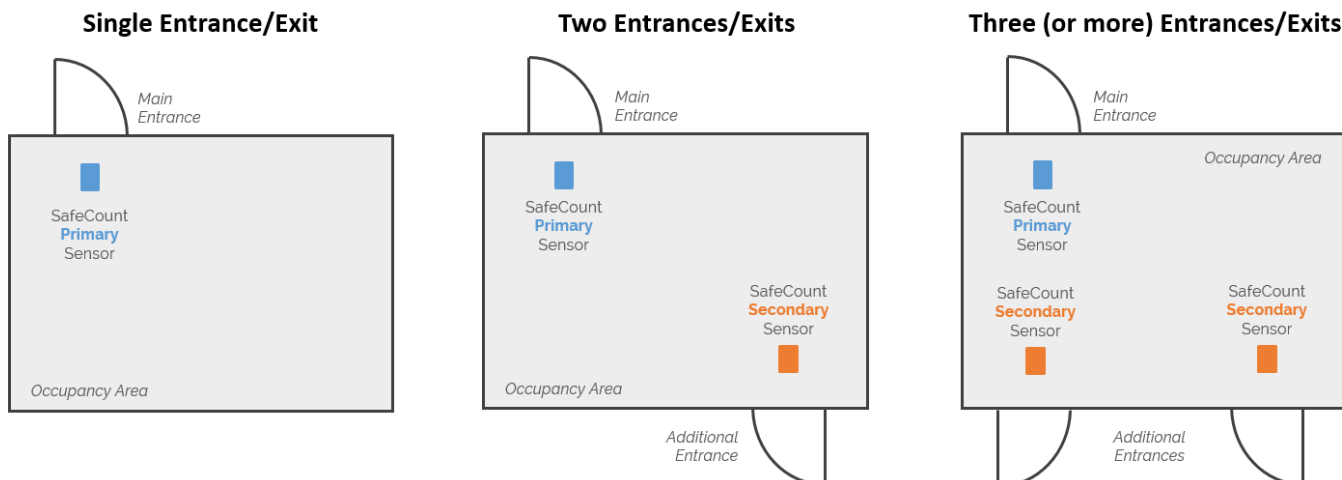

Please note, a building may contain more than one occupancy area. For example an occupancy area could be a staff canteen, the washroom facilities or the building as a whole. Each of these separate occupancy areas will require a Primary SafeCount sensor and as many Secondary SafeCount sensors as needed to cover all entrances/exits.

SafeCount also supports zone in zone setups, for example a canteen could be monitored as one occupancy area that is within a larger occupancy area of a whole building. Please contact Irisys for assistance.



Display Kits and Accessories

Now that the occupancy of an area is being monitored, this information should be displayed in real-time to your building users so they can act on it and self regulate. These display kits work seamlessly with SafeCount and include everything you need to connect them to the SafeCount system.

(cont...)

WHAT EQUIPMENT IS REQUIRED? (cont.)

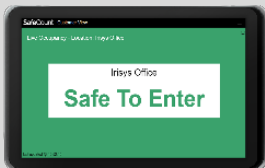
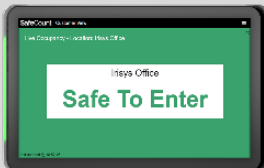

- Display Screens

	10" LCD Display Kit	10" LCD Lightbar Tablet Display Kit	21.5" LCD Display Kit
			
Part Number	IWC6254	IWC6255	IWC6256
Description	10" commercial-grade, non-touch smart LCD display. Supports customisable and split screen display messaging.	10" commercial-grade, PoE compatible touchscreen LCD display including matching light bars. Supports customisable and split screen display messaging.	21.5" commercial-grade, non-touch smart LCD display. Supports customisable and split screen display messaging.
Example uses	Office areas, meeting rooms, washrooms	Office areas, meeting rooms, washrooms	Office areas, dining areas, building entrance kiosks
Dimensions (W x H x D)	270 x 170 x 29mm	270 x 170 x 29mm	538 x 331 x 37mm
Requirements	Permanent power (via power outlet or PoE*) and a WiFi router connected to SafeCount system (*depending on model)		

(cont...)

WHAT EQUIPMENT IS REQUIRED? (cont.)

- Display Signage

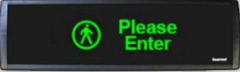
	Traffic Light Display Kit	Mini LED Display Kit	Large 470 LED Display Kit	Weatherproof 580 LED Display Kit
				
Part Number	IWC6252	IWC6257	IWC6258	IWC6260
Description	IP65 rated 'Red and Green' signal indicator for use internally or externally. Connects to the SafeCount sensor via an I/O adapter included in the kit.	'Enter / Do Not Enter' LED Mini display for internal use only. Connects to the SafeCount sensor via an I/O adapter included in the kit.	'Enter / Do Not Enter' ultra-bright LED display for internal use only. Connects to the SafeCount sensor via an I/O adapter included in the kit.	'Enter / Do Not Enter' ultra-bright LED display for internal and external use. Connects to the SafeCount sensor via an I/O adapter included in the kit.
Example uses	Restaurants, retailers, public buildings and spaces	Washrooms, meeting rooms	Restaurants, canteens, retailers, public buildings	Restaurants, retailers, public buildings
Dimensions (W x H x D)	150 x 430 x 265mm	160 x 108 x 38.5mm	470 x 178 x 24mm	580 x 178 x 24mm
Requirements	Permanent power (via power outlet). Kits contain 24V PSU (power supply unit), I/O Module to interface with the SafeCount sensor, 2 x 5M cables and all required connectors.			

- Staff Detection Lanyards



The SafeCount sensor has built in functionality that can exclude staff members from the occupancy count. This is achieved with a simple lanyard that staff members wear whilst going about their normal duties. It does not identify individual staff members, just that they are a staff member and should not be counted when entering or exiting the occupancy area.

Example uses include retail staff, door/security staff and cleaning staff.

Please note, lanyards need to be worn on top of clothing, not underneath, to be detected by the SafeCount sensor and stop the wearer from being counted.

EXAMPLE EQUIPMENT LISTS

Washroom Example

Single entryway with Mini LED display kit

Required equipment:

- 1 x Primary SafeCount Sensor
- 1 x Mini LED Display Kit
- 1 x PoE Switch
- CAT5/6 cable(s)

Optional:

- 1 x WiFi Router

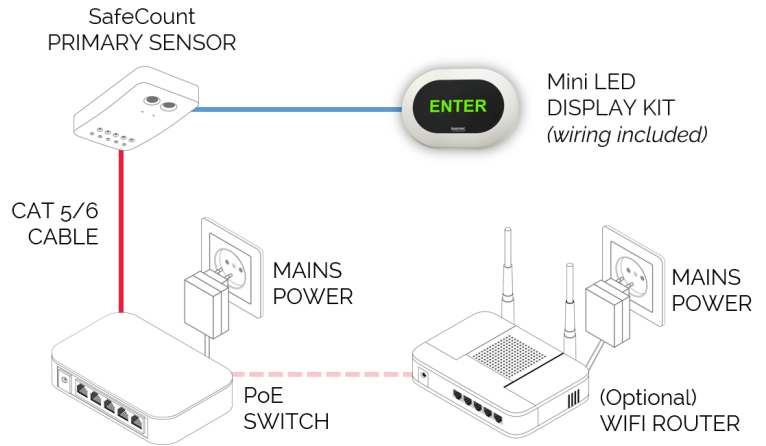

Canteen Example

Two entryways with Ultra 470 LED display kit and 10" Smart LCD Tablet display kit

Required equipment:

- 1 x SafeCount Primary Sensor
- 1 x SafeCount Secondary Sensor
- 1 x Large 470 LED Display Kit
- 1 x 10" Smart LCD Tablet Display Kit
- 1 x PoE Switch
- 1 x WiFi Router
- CAT5/6 cables

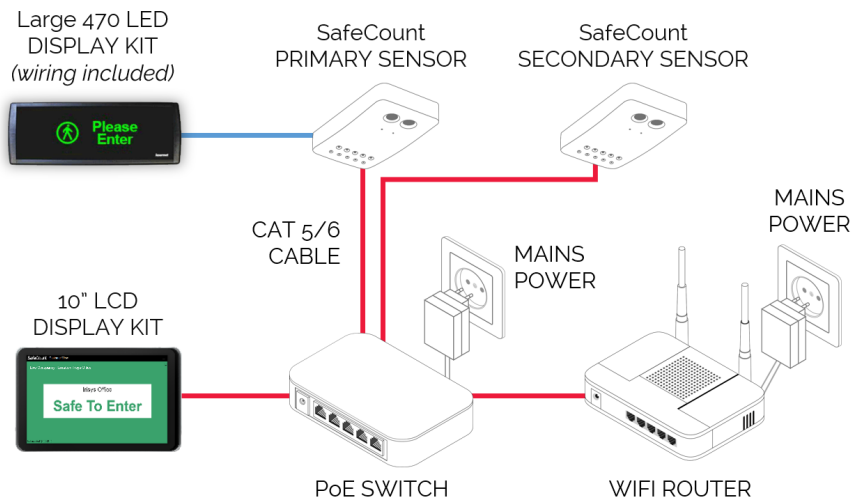

HOW TO ORDER SAFECOUNT

Step 1

Count how many entryways (doorways) there are to the building/area/room that you want to monitor the occupancy of.

Step 2

Review each entryway to make sure that they meet the SafeCount Sensor mounting requirements

Step 3

Order ONE Primary sensor for the main entrance to the area.

For each additional entrance, order a Secondary SafeCount sensor.

Step 4

Review Display Kits and Accessories. Order as required.

Step 5

If advanced reporting and analytics are required, add SafeCount Plus cloud subscription (*SafeCount system will require internet connection)

Step 6

Review complete SafeCount system configuration and order PoE switches, WiFi routers and network cables as required.



 **InfraRed Integrated Systems Ltd**
Park Circle, Tithe Barn Way, Swan Valley
Northampton NN4 9BG
United Kingdom

 +44 (0)1604 594200

 sales@irisys.co.uk

 www.irisys.net

Part of Fluke since 2012

