

FlexChain

SICK
Sensor Intelligence.



Described product

FlexChain

Manufacturer

SICK AG
Erwin-Sick-Str. 1
79183 Waldkirch
Germany

Legal information

This work is protected by copyright. Any rights derived from the copyright shall be reserved for SICK AG. Reproduction of this document or parts of this document is only permissible within the limits of the legal determination of Copyright Law. Any modification, abridgment or translation of this document is prohibited without the express written permission of SICK AG.

The trademarks stated in this document are the property of their respective owner.

© SICK AG. All rights reserved.

Original document

This document is an original document of SICK AG.

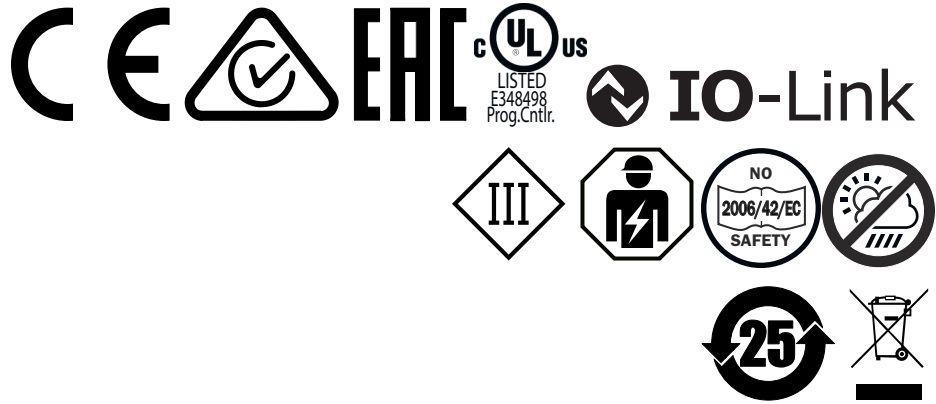

Contents

1	About this document.....	5
1.1	Information on the operating instructions.....	5
1.2	Scope.....	5
1.3	Explanation of symbols.....	5
1.4	Customer service.....	6
2	Safety information.....	7
2.1	Intended use.....	7
2.2	Limitation of liability.....	8
2.3	Requirements for skilled persons and operating personnel.....	8
2.4	Hazard warnings and operational safety.....	9
2.5	Repair.....	9
3	Product description.....	10
3.1	Product ID.....	10
3.1.1	Type labels.....	10
3.2	Product features and functions.....	10
3.2.1	Device view.....	10
4	Mounting.....	12
4.1	Scope of delivery.....	12
4.2	Installation requirements.....	12
4.3	Installing the system.....	12
5	Electrical installation.....	13
5.1	Notes on electrical installation.....	13
5.2	Schematic arrangement.....	14
5.3	Pin assignment of the connections.....	15
5.4	Connecting the supply voltage.....	16
5.5	Digital interfaces.....	16
6	Commissioning.....	17
6.1	Commissioning via the control panel.....	17
7	Operation.....	20
7.1	Configuring the FlexChain system.....	20
7.1.1	Functions structure.....	20
7.1.2	Structure of SOPAS.....	21
7.1.3	Basic information on the FlexChain system.....	22
7.1.4	Teach & Positioning.....	23
7.1.5	Zones.....	28
7.1.6	Logics.....	32
7.1.7	PINS.....	34
7.1.8	Process data.....	36
7.1.9	Settings.....	39

7.2	IO-Link specific settings.....	41
7.3	CANopen-specific settings.....	41
7.3.1	Overview.....	41
7.3.2	Acyclic data (service data).....	45
7.3.3	Cyclic data (process data).....	45
7.3.4	Object library.....	46
7.3.5	1xxxh – Standard objects.....	47
7.3.6	Standard object for defining process data.....	50
7.4	RS485 configuration.....	55
8	Diagnostics and troubleshooting.....	58
8.1	General diagnostic information.....	58
8.2	Detailed diagnostic information.....	58
8.3	Troubleshooting.....	62
9	Maintenance.....	64
9.1	Maintenance.....	64
10	Decommissioning.....	65
10.1	Disassembly and disposal.....	65
10.2	Returning devices.....	65
11	Technical data.....	66
11.1	Host performance.....	66
11.2	Interfaces host.....	66
11.3	Host software features.....	67
11.4	System response time.....	67
11.5	Mechanics/electronics/host.....	67
11.6	Technical data guests.....	68
11.6.1	Technical data G6-C – general.....	68
11.6.2	Technical data GL6-C.....	69
11.6.3	Technical data GSE6-C.....	69
11.6.4	Technical data GTB6-C.....	69
11.6.5	Technical data SLG-2.....	69
11.7	Dimensional drawings.....	72
11.8	FlexChain Host control panel.....	77
12	Accessories.....	78
13	Annex.....	79
13.1	EU declaration of conformity and certificates.....	79
13.2	Licenses.....	79

1 About this document

1.1 Information on the operating instructions

These operating instructions provide important information on how to use devices from SICK AG.

Prerequisites for safe work are:

- Compliance with all safety notes and handling instructions supplied
- Compliance with local work safety regulations and general safety regulations for device applications

The operating instructions are intended to be used by qualified personnel and electrical specialists.



NOTE

Read these operating instructions carefully before starting any work on the device, in order to familiarize yourself with the device and its functions.

The instructions constitute an integral part of the product and are to be stored in the immediate vicinity of the device so they remain accessible to staff at all times. Should the device be passed on to a third party, these operating instructions should be handed over with it.

These operating instructions do not provide information on operating the machine in which the device is integrated. For information about this, refer to the operating instructions of the specific machine.

1.2 Scope

These operating instructions serve to incorporate the device into a customer system. Instructions are given in stages for all actions required.

These instructions apply to all listed device variants of the product.

Available device variants are listed on the online product page.

► www.sick.com/FlexChain

Commissioning is described using one particular device variant as an example.

1.3 Explanation of symbols

Warnings and important information in this document are labeled with symbols. The warnings are introduced by signal words that indicate the extent of the danger. These warnings must be observed at all times and care must be taken to avoid accidents, personal injury, and material damage.



DANGER

... indicates a situation of imminent danger, which will lead to a fatality or serious injuries if not prevented.



WARNING

... indicates a potentially dangerous situation, which may lead to a fatality or serious injuries if not prevented.

**CAUTION**

... indicates a potentially dangerous situation, which may lead to minor/slight injuries if not prevented.

**NOTICE**

... indicates a potentially harmful situation, which may lead to material damage if not prevented.

**NOTE**

... highlights useful tips and recommendations as well as information for efficient and trouble-free operation.

1.4 Customer service

If you require any technical information, our customer service department will be happy to help. To find your agency, see the final page of this document.

**NOTE**

Before calling, make a note of all type label data such as type code, serial number, etc., to ensure faster processing.

2 Safety information

This document is an original document of SICK AG. All rights reserved. Subject to change without notice.

Read these safety notes and take them into account when working with the sensor. The safety notes do not describe how to use the sensor.

You can find technical data and information on commissioning the sensor in the operating instructions. They can be downloaded at this Internet site: www.sick.com (enter the part number of the sensor in the search field and you will find the operating instructions under Downloads).



- Connection, mounting, and setting is only to be performed by trained specialists.



- Not a safety component in accordance with the EU Machinery Directive.



- Do not install the sensor in places exposed to direct sunlight or other weather conditions unless this is expressly permitted in the operating instructions.



WARNING

Fire

Electrical connections must be made in compliance with local and national electrical regulations and standards. The sensor must be protected with a fuse suitable for the cross-circuit of the connecting cable; for details, see the operating instructions.

For devices with a supply voltage > 50 V (AC), 75 V (DC):



WARNING

Lost of electrical safety (protection class)

When commissioning, protect the device from moisture and contamination.

Unless stated otherwise in the operating instructions, the sensor may only be used in an area with maximum degree of contamination 3, maximum overvoltage category II and a maximum altitude of 2,000 m above sea level.

2.1 Intended use

The FlexChain is a sensor system comprising a central unit (host) and connected guests (sensors) that is used for optical and non-contact detection of objects.

The FlexChain must be mounted and installed according to these operating instructions, and may only be operated according to its intended function.

The FlexChain is not equipped with any direct safety devices. The system designer must provide measures to ensure the safety of persons and systems in accordance with the legal guidelines.

Sick AG assumes no liability for losses or damage arising from the use of the product, either directly or indirectly. This applies in particular to use of the product that does not conform to its intended purpose and is not described in this documentation.

2.2 Limitation of liability

Applicable standards and regulations, the latest state of technological development, and our many years of knowledge and experience have all been taken into account when assembling the data and information contained in these operating instructions. The manufacturer accepts no liability for damage caused by:

- Failure to observe the operating instructions
- Improper use
- Use by untrained personnel
- Unauthorized conversions
- Technical modifications
- Use of unauthorized spare parts, wear and tear parts, and accessories

With special variants, where optional extras have been ordered, or owing to the latest technical changes, the actual scope of delivery may vary from the features and illustrations shown here.

2.3 Requirements for skilled persons and operating personnel



WARNING

Risk of injury due to insufficient training!

Improper handling of the device may result in considerable personal injury and material damage.

- All work must only ever be carried out by the stipulated persons.

The operating instructions state the following qualification requirements for the various areas of work:

- **Instructed personnel** have been briefed by the operating entity about the tasks assigned to them and about potential dangers arising from improper action.
- **Skilled personnel** have the specialist training, skills, and experience, as well as knowledge of the relevant regulations, to be able to perform tasks assigned to them and to detect and avoid any potential dangers independently.
- **Electricians** have the specialist training, skills, and experience, as well as knowledge of the relevant standards and provisions to be able to carry out work on electrical systems and to detect and avoid any potential dangers independently. In Germany, electricians must meet the specifications of the BGV A3 Work Safety Regulations (e.g., Master Electrician). Other relevant regulations applicable in other countries must be observed.

The following qualifications are required for various activities:

Activities	Qualification
Mounting, maintenance	<ul style="list-style-type: none"> ■ Basic practical technical training ■ Knowledge of the current safety regulations in the workplace
Electrical installation, device replacement	<ul style="list-style-type: none"> ■ Practical electrical training ■ Knowledge of current electrical safety regulations ■ Knowledge of the operation and control of the devices in their particular application
Commissioning, configuration	<ul style="list-style-type: none"> ■ Basic knowledge of the design and setup of the described connections and interfaces ■ Basic knowledge of data transmission ■ Knowledge of the operation and control of the devices in their particular application

Activities	Qualification
Operation of the devices in their particular application	<ul style="list-style-type: none"><li data-bbox="762 218 1422 275">■ Knowledge of the operation and control of the devices in their particular application<li data-bbox="762 275 1422 331">■ Knowledge of the software and hardware environment in the application

2.4 Hazard warnings and operational safety

Please observe the safety notes and the warnings listed here and in other chapters of these operating instructions to reduce the possibility of risks to health and avoid dangerous situations.

2.5 Repair

The product is a replacement device. The device is not intended to be repaired. Interference with or modifications to the device on the part of the customer will invalidate any warranty claims against SICK AG.

3 Product description

3.1 Product ID

3.1.1 Type labels

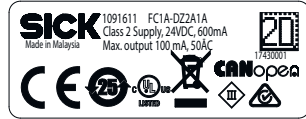

Figure 1: Type label of FlexChain CANopen

3.2 Product features and functions

3.2.1 Device view

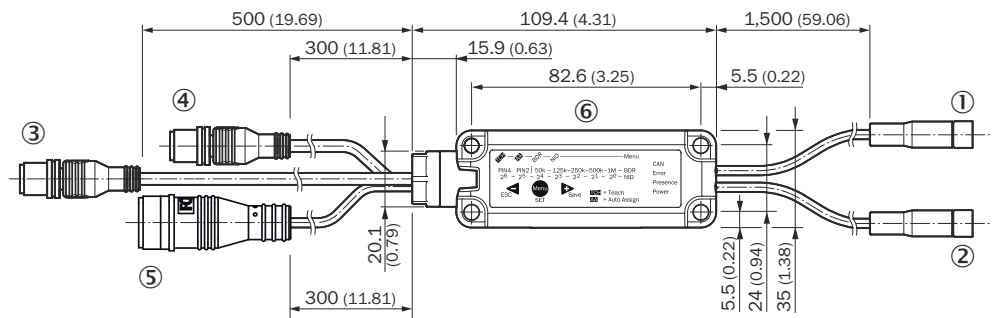

Figure 2: Sample view of FlexChain Host CANopen variant

- ① Port-A, pigtail M8, 4-pin, female
- ② Port B, pigtail M8, 4-pin, female
- ③ PLC PLC, pigtail M12, 5-pin, male
- ④ CANopen PLC, pigtail M12, 5-pin, male
- ⑤ Micro USB
- ⑥ Control panel

Structure

A FlexChain system comprises a host and a number of guests (sensors). As shown in the image below, the system components are connected sequentially (bus topology). A system comprises a host and at least one guest. A total of up to 60 guests can be connected to one host (the number depends on the type of sensors connected).

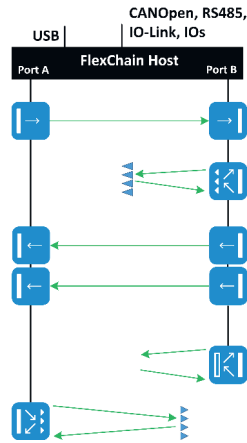

Figure 3: Structure of FlexChain system

Function

The FlexChain system operates similarly to a light grid. That is, each individual channel in the system is processed sequentially. This principle means that only one channel at a time is active. Consequently, there is no possibility of mutual interference within a system, and the guests can be installed arbitrarily close to one another without any interference occurring. Due to this sequential processing, the scan time and the response time of the system depend on the number of connected guests. The total times are short, however, because the processing interval between two channels is in the μs range (see "Technical data", page 66).

With the FlexChain system and in SOPAS, the term “channel” is used to cover the variations of sensors and actuators that can be used. For example, light grids, photoelectric sensors and photoelectric retro-reflective sensors are light beams.

Host:

- Supplies the guests with current.
- Collects the status of each individual channel.
- Requests diagnostic data from the individual guests.
- Processes the collected data (if desired).
- Forwards the collected and/or processed data via various interfaces.

Guest:

- Guests are connected to one another via a standard M8 pigtail.
- Guests forward information to the host.
- Can be arranged differently within the system.
- Guests employing different sensor technologies can be integrated into the same system.
- Senders & receivers that belong together must be connected to separate ports.

4 Mounting

4.1 Scope of delivery

- FlexChain host with 2x bus terminator
- Quickstart
- Safety notes

The FlexChain guests and mounting accessories are not included in the scope of delivery and need to be purchased separately.

4.2 Installation requirements

- Typical space requirement for the device, see type-specific dimensional drawing, see ["Technical data", page 66](#).
- Comply with technical data, such as the permitted ambient conditions for operation of the device (e.g., temperature range, EMC interference emissions, ground potential).
- To prevent condensation, avoid exposing the device to rapid changes in temperature.
- Protect the device from direct sunlight.
- Protect the device from external light sources.
- The device must only be mounted using the pairs of mounting threads/fixing holes provided for this purpose.
- Shock and vibration-free mounting.

4.3 Installing the system

Installing the FlexChain host

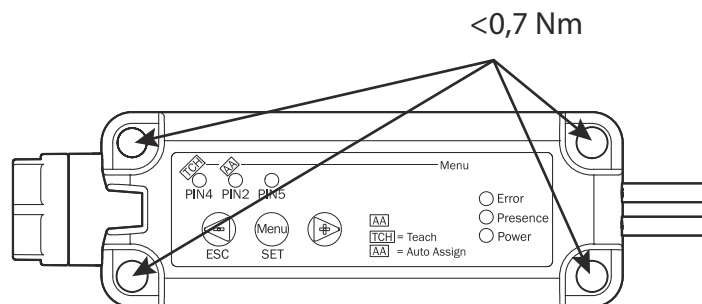

Figure 4: FlexChain host - installation

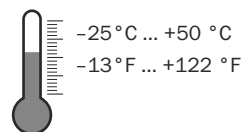

Figure 5: Temperature

Installing the FlexChain guest

The procedure for installing a guest can vary significantly depending on the device family or device type. See the instructions supplied with the device for installation instructions.

5 Electrical installation

5.1 Notes on electrical installation



NOTICE

Equipment damage due to incorrect supply voltage!

An incorrect supply voltage may result in damage to the equipment.

- Only operate the host with safety/protective extra-low voltage (SELV/PELV).
- The host is a device of protection class III.



NOTICE

Equipment damage due to incorrect supply voltage!

An incorrect supply voltage may result in damage to the equipment.

- Only operate the host with an LPS (limited power source) in accordance with IEC 60950-1 or an NEC Class 2 power supply unit.



NOTICE

Equipment damage or unpredictable operation due to working with live parts!

Working with live parts may result in unpredictable operation.

- Only carry out wiring work when the power is off.
- Only connect and disconnect electrical connections when the power is off.



NOTICE

Device damage due to incorrect connection!

Incorrect connection may result in damage to the FlexChain system or peripheral devices.

- If connection cables are required, use twisted pair connection cables.
- Standard M8 4-pin connection cables can also be used in many applications.

- **The electrical installation must only be performed by electrically qualified personnel.**
- **Standard safety requirements must be observed when working on electrical systems!**
- Only switch on the supply voltage for the device when the connection tasks have been completed and the wiring has been thoroughly checked.
- When using extension cables with open ends, ensure that bare wire ends do not come into contact with each other (risk of short-circuit when supply voltage is switched on!). Wires must be appropriately insulated from each other.
- Wire cross-sections in the supply cable from the user's power system must be selected in accordance with the applicable standards.
- Only operate the device with an LPS (limited power source) in accordance with IEC 60950-1 or an NEC Class 2 power supply unit.
- All circuits connected to the device must be designed as SELV/PELV circuits.
- Operation in short-circuit protected network at max. 8 A.



NOTE

Layout of data cables

- Use shielded data cables with twisted-pair wires.
 - Implement the shielding design correctly and completely.
 - To avoid interference, e.g., from switching power supplies, motors, clocked drives, and contactors, always use cables and layouts that are suitable for EMC.
 - Do not lay cables over long distances in parallel with voltage supply cables and motor cables in cable channels.
-

The IP enclosure rating for the device is only achieved under the following conditions:

- The cables plugged into the connections are screwed tight.

If these instructions are not complied with, the IP enclosure rating for the device is not guaranteed!

5.2 Schematic arrangement

The first guest is connected to the host using the pigtail. It can be connected to either port A or port B. Up to 30 sensors in total can be connected per port.

All guests have an M8 4-pin male connector and an M8 4-pin female connector (pigtail). The pigtail can always be connected to the male connector of the next guest.

The bus terminator must be connected at the end of the system. This is included in the scope of delivery of the FlexChain host.

With regard to the arrangement of the guests on Port A and Port B, there is only one restriction for sender and receiver sensors: the sender and the associated receiver must not be connected to the same port.

If the pigtail cable is insufficiently long, it can be extended using an M8 4-pin cable.

Ensure that the total cable length of the system does not exceed 40 m when doing so.



NOTE

Sender-receiver assignment:

The assignment of senders and receivers must be taken into account when setting up the guest chains and cannot be determined directly via the configuration parameters. This is based on the automatic assignment algorithm.

Assignment algorithm:

The first address (A1) is considered starting from port A. If a counterpart is needed for this, the addresses of port B are checked for suitability in ascending order, starting with B1. If an counterpart is found (e.g. B3), the next address at port A that requires an counterpart (e.g. A3) is considered.

However, the search for the matching partner does not start again at B1 but after the previously found counterpart on port B (in the example, from B4). "Crossed" assignments of sender-receiver pairs are not possible if the chains at ports A and B are regarded as two parallel lines. If no counterpart is found during the aforementioned iteration, the "Error: Sender Missing" or "Error: Receiver Missing" message is displayed via the Chain Issue (IO-Link index 300).

"Error: Incompatible Sender Receiver Couple" is reported if an counterpart is present but incompatible (e.g. if the sender has more channels than the receiver).

The algorithm terminates when the first error is found, since the system cannot be run in this state. In order to catch all of the aforementioned errors correctly, port B is processed after all addresses of port A have been processed.

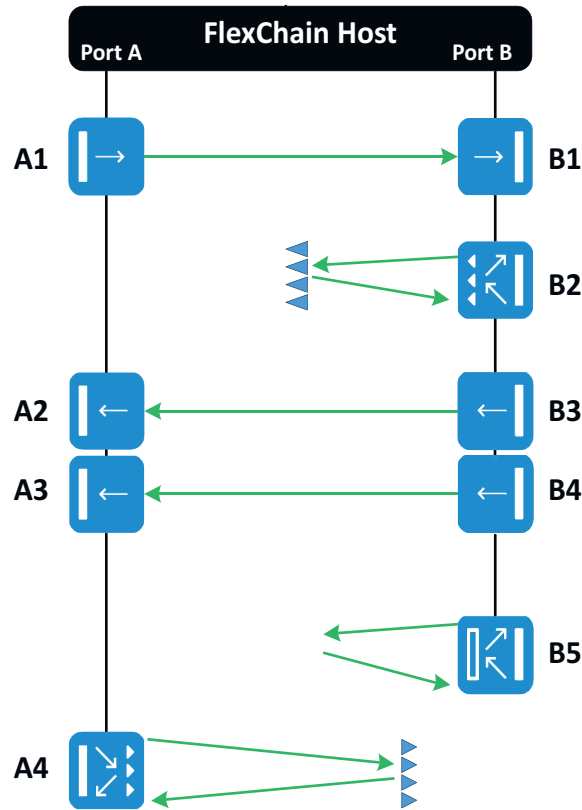

Figure 6: Schematic arrangement

5.3 Pin assignment of the connections

Overview of pin assignment - FlexChain host

Table 1: DC

Flex-Chain Host	PLC					micro USB	Port-A / Port-B
	Standard IO-Link	Advanced IO-Link	RS485	CANopen			
				System/Q	CAN connector		
1	+ (L+)	+ (L+)	+ (L+)	+ (L+)	n.c.	+5V	CANH
2	Q2 / IN1	Q2 / IN1	Q2 / IN1	Q2 / IN1	n.c.	D-	CANL
3	M	M	M	M	GND	D+	12Vout
4	Q1 / C	Q1 / C	Q1 / C	Q1 / C	CAN1_H	n.c.	GND
5	Q3 / In2	Q3/IN2	n.c.	n.c.	CAN1_L	GND	-
6	-	Q4/IN3	n.c.	-	-	-	-
7	-	Q5/IN4	RS485_A	-	-	-	-
8	-	Q6/IN5	RS485_B	-	-	-	-

The system can be configured via the USB interface, SOPAS, CANopen and IO-Link. A micro USB -> USB-A adapter cable is required to connect to a computer.

Overview of pin assignment - FlexChain guests

Table 2: DC

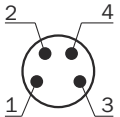
Guest	
1	CAN high
2	CAN low
3	12 V _{out}
4	GND
	

5.4 Connecting the supply voltage



NOTICE

Risk of damage to the host!

The host can become damaged if it is connected to a voltage supply that is already switched on.

- Only connect the host when the supply cable is de-energized.

The host must be connected to a power supply unit with the following properties:

- 24 V voltage supply $\pm 20\%$ or DC 19.2 V – 28.8 V (SELV/PELV as per currently applicable standards)
- The current consumption depends on the number of connected sensors and is typically 100 mA and maximum 850 mA.

To ensure protection against short-circuits/overload in the customer's supply cables, the wire cross-sections used must be appropriately selected and protected.

5.5 Digital interfaces

The digital interfaces can be configured via SOPAS, Engineering Tool or directly via the CANopen and IO-Link serial interfaces. Apart from PIN4, every digital interface can be configured as a digital input or digital output.

Each digital interface can be assigned different functions (see "Operation", page 20). The signal state of each individual interface (HIGH/LOW) is shown on the FlexChain Host display.

6 Commissioning

6.1 Commissioning via the control panel



NOTE

The commissioning described here is carried out via the control panel, commissioning via SOPAS ET, IO-Link, CANopen is also possible.

Perform any other operation with the SOPAS ET user interface. Download at: www.sick.com

1. Connect sensors to port A and port B.
2. Connect the power supply. The Power LED lights up green.
3. Perform AutoAssign
AutoAssign detects all connected guests. Automated assignment of guest positions and zones, e.g. A₁ ... A_N, B₁ ... B_M.

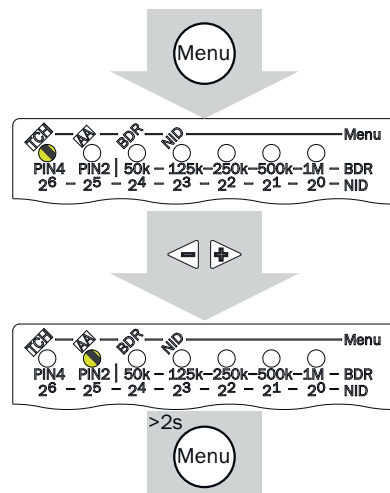

4. Perform teach-in
Perform teach-in for sensors. Set sensors with potentiometer directly on the sensor.

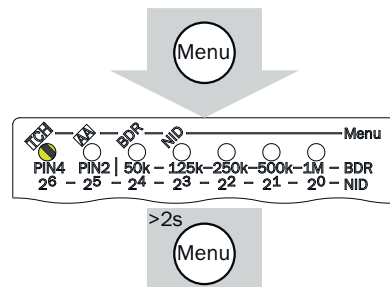

5. Baud rate (RS485, CANopen)
Set baud rate (BDR) for FlexChain Host variant with RS485 and CANopen.

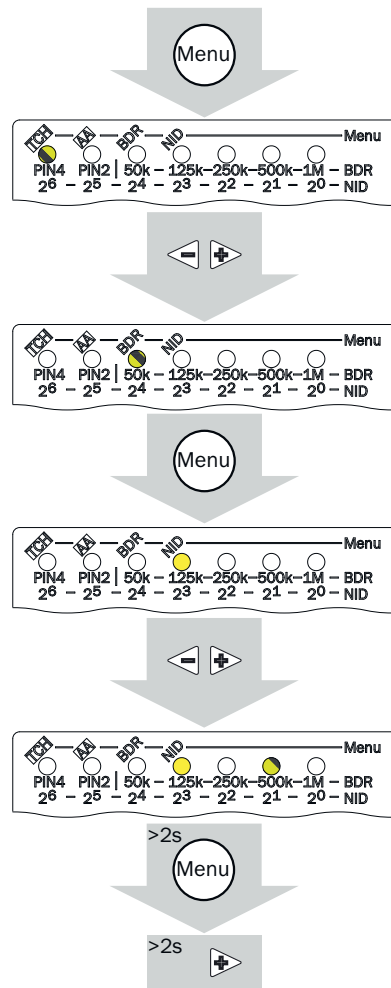

	kbaud
RS485	9.6, 38.4, 115.2, 230.4, 460.8
CANopen	50, 125, 250, 500, 1,000

6. NodeID (CANopen)

Set NodeID (NID) for FlexChain Host with CANopen. A single value or several values can be set or deleted (bit display).

A power cycle is required after changing the CANopen baud rate and NodeID.

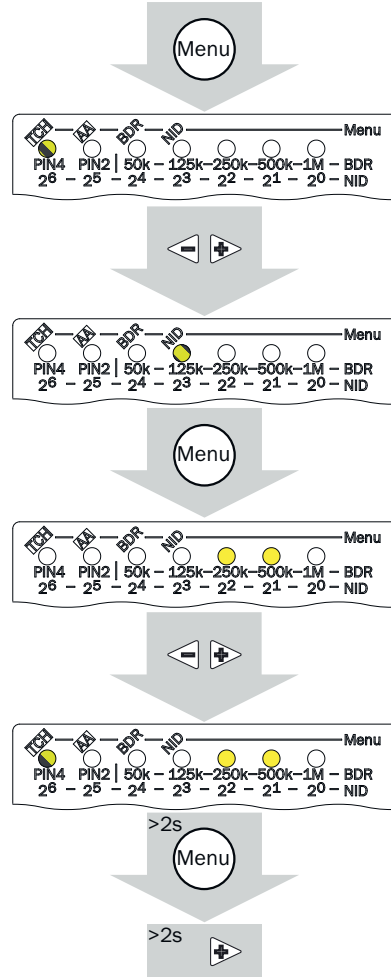

7 Operation

7.1 Configuring the FlexChain system

The complete configuration is possible via the USB port and SOPAS ET, via IO-Link and via CANopen. In addition, the main settings required for commissioning can be made via the display (see "Commissioning", page 17). Interface-specific settings can be found at the end of this chapter.

To configure the system via SOPAS ET you will need the SOPAS software, the SOPAS Device Description (SDD), and a USB connection.



NOTE

The USB interface is intended only for configuring the device and must be unplugged during operation.

7.1.1 Functions structure

The graphic below basically describes the functional structure and makes it easier to understand the FlexChain system.

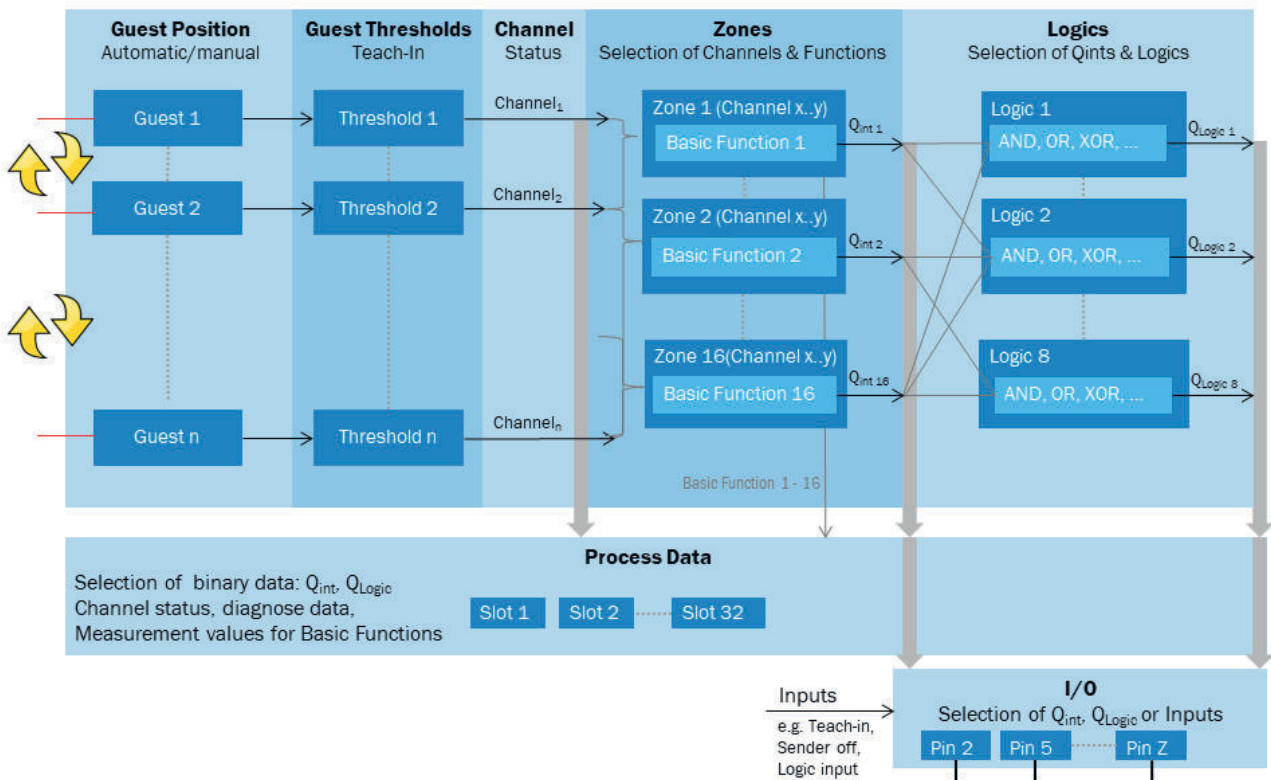

Figure 7: Function overview

- **Guest Position:**
Each guest or pair of guests (for sender/receiver sensors) requires a defined position in the FlexChain system. The process data sequence is ordered depending on the position. With suitable positioning it is also possible to define meaningfully connected zones.
If a FlexChain system has been set up or the guests are connected to the host, the guests can be automatically positioned using the “Automatic Position Assignment” or “Auto Assignment” methods. Manual positioning of each individual guest is also possible.
- **Guest Thresholds:**
The switching thresholds of the connected sensors can be set in “Guest Thresholds”. This is done either via a central teach-in for all sensors or via a teach-in of a selected sensor.
- **Channel:**
Once a positioning and a switching threshold setting have been carried out, the system is ready for operation. Now the states of each individual channel can be output via the process data (see also “Process Data”), and/or the sensor data can be used for further processing.
- **Zones:**
In “Zones”, areas can be defined between two channels within which an evaluation is made by selectable functions within the zone. The resulting states can either be used for further processing or output directly via the I/Os (see “I/Os”) and/or via the process data (see “Process Data”).
- **Logics:**
The states of the different zones can be further processed by simple logic gates. In addition, external input signals can also be integrated into the logic gates. The states of the logic gates can be output via the I/Os (see “I/Os”) and/or via the process data (see “Process Data”).
- **Process Data:**
The information is transmitted to the control via a serial interface using the process data. An individual configuration of the process data is possible.
- **I/O:**
Binary data can be transferred via I/O. The I/Os are freely configurable. A configuration as input for further processing (e.g. as logic input signal) is given.

7.1.2 Structure of SOPAS

The SOPAS screen for FlexChain is divided into a number of tabs (orange). Every tab provides a specific set of parameterization functions. You can easily jump back and forward between the tabs.

The structure of the visualization is similar in each tab:

- Important basic information is displayed on the left side of the Sopas window (1, red). This includes diagnostic information (see chapter 8) or the status of the pins.
- The channel status can be seen in the middle of the screen (2, green). If a channel is free, it is displayed in green with a continuous line. If the channel is blocked by an object, the channel is displayed with a red dashed line. In case of an error (e.g. Quality of Run Alarm), the error is directly visible in the channel status at the respective guest.
- On the right side of the Sopas window (3, blue), you can either make settings or call up individual information.

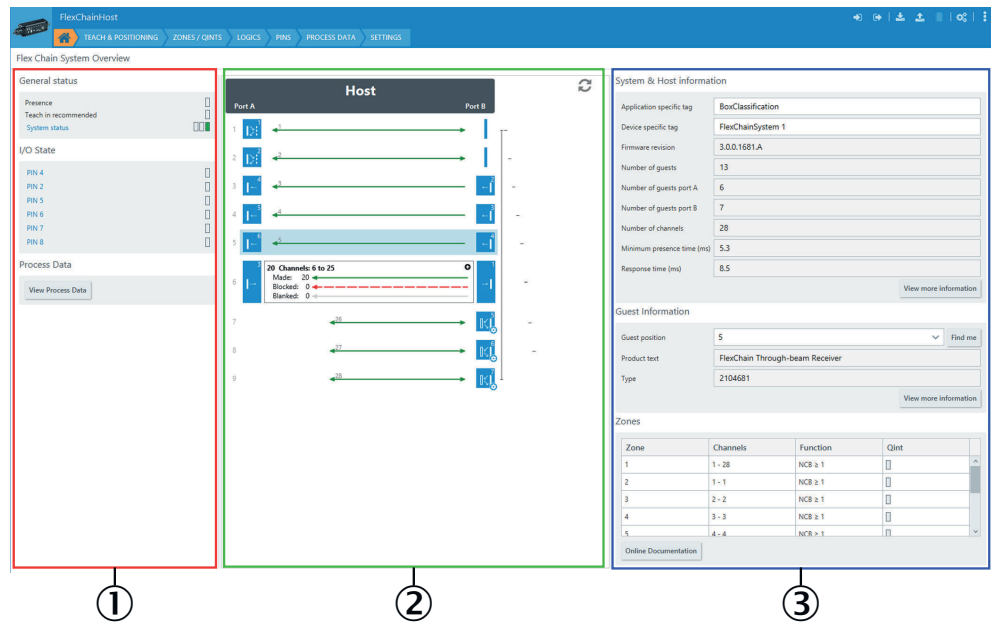

Figure 8: Structure of SOPAS – home

7.1.3 Basic information on the FlexChain system

7.1.3.1 SOPAS

The Home tab does not contain any settings. The purpose of this tab is to provide you with information and status details for the connected FlexChain system. This includes information such as performance values of the system, higher-level diagnostic information and states of the individual switching outputs.

In addition, detailed information on the selected guest can be called up by selecting a specific guest.

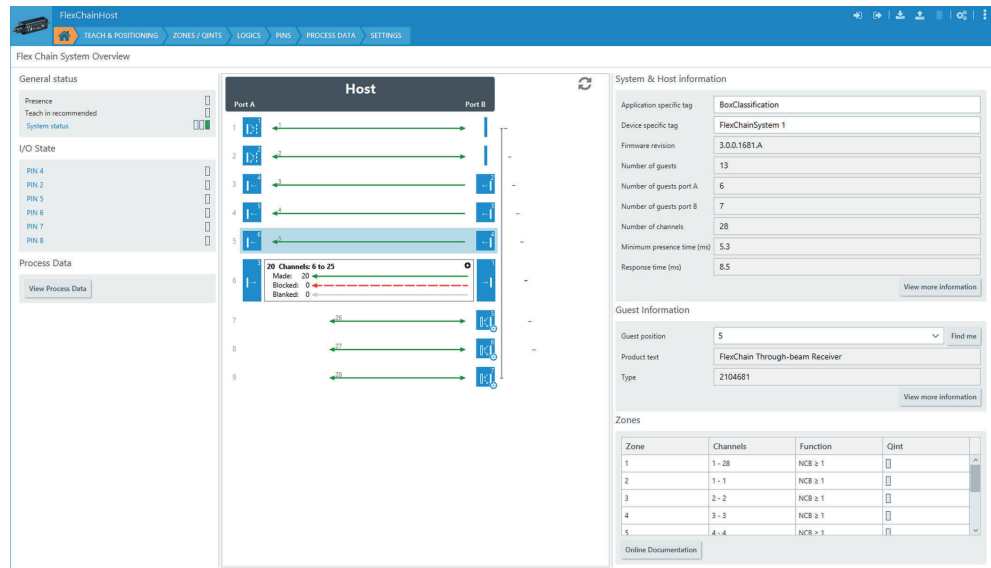

Figure 9: Guest Information



NOTE

Detailed information can be found in the IO-Link supplement (8023651) and/or the EDS description (8024673).

Table 3: Basic information IO-Link & CANopen index

Object name	Description	IO-Link Index	CAN-Open Index
System Properties	Retrieval of various system information such as response time, number of connected guests, etc.	301	0x212D
Guest Address Selector	Selection of a specific guest	302	0x212E
Guest Info	Retrieval of detailed guest information of the selected guest	303	0x212F
Channel Status	Information about the status of each individual channel (object there or not). This information is the raw data from the FlexChain system and can be used for further processing.	480	0x21E0
PIN status	Specifies the pin status (high/low status at the individual pin) via a byte. The bits used depend on the hardware variant of the FlexChain Host.	483	0x21E3
System status	Contains general diagnostic information such as error and/or warning message such as quality of run alarm, hardware error, etc.	100	0x2064
Guest Teach-In Status	Indicates whether a teach-in is recommended by the system or whether there is an error.	307	0x2133

7.1.4 Teach & Positioning

The Teach & Positioning tab can be used to teach in the switching threshold of individual guests or all guests at once. The guest position can also be set automatically (automated position assignment) or changed manually.

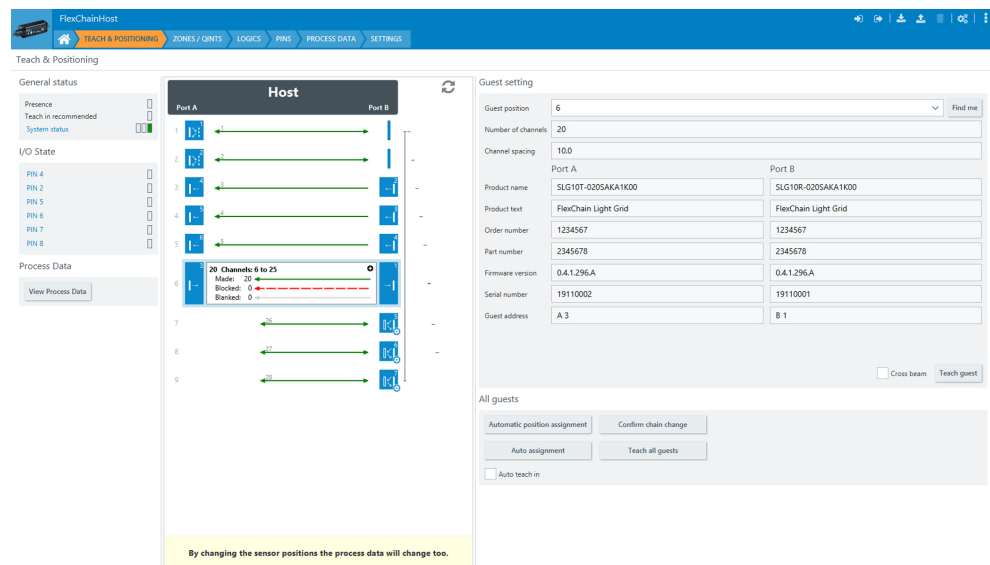

Figure 10: Teach & Positioning

Automated positioning

The “Automated position assignment” method is used to automatically assigned a position to every guest in the FlexChain system. Positions are assigned based on the following rules:

- 1 The first position is the first guest connected to port A. Further positions are then assigned in increasing numerical order for the guests hanging off port A.
- 2 All guests on port B are then numbered according to the same principle as in step 1.
- 3 Sender/receiver sensors are always jointly assigned a position. The receiver serves as the reference during positioning.

The transmitted process data word also varies according to the position of the guest. For example, the first channel of the guest at position 1 is represented by the first bit in the process data word. This means that the sequence within the process data word depends directly on the guest positions.

Note when changing the number of guests: if a guest is removed or a new guest connected, this guest is not taken into consideration when using the “Automated position assignment” positioning method. If there is a changed arrangement, the system reports a “Chain Issue Error” “Confirm Chain Changed” after a reboot and refuses operation. You need to either use the “Confirm chain change” method beforehand, or perform the “Auto assignment” method (see below).



NOTE

“Automatic Assignment” also changes the position and zone settings if necessary. (see “Automated assignment”, page 26)

Manual positioning

The position of the guest can be individually adapted via the IO-Link, CANopen and/or via SOPAS. This option was implemented because the automated positioning may not always represent the actual physical position in the application. The manual positioning option was therefore created for simpler organization or easier interpretation of the process data.

A comparison of the addressing, the automated positioning, and the desired positioning is shown in figure 11.

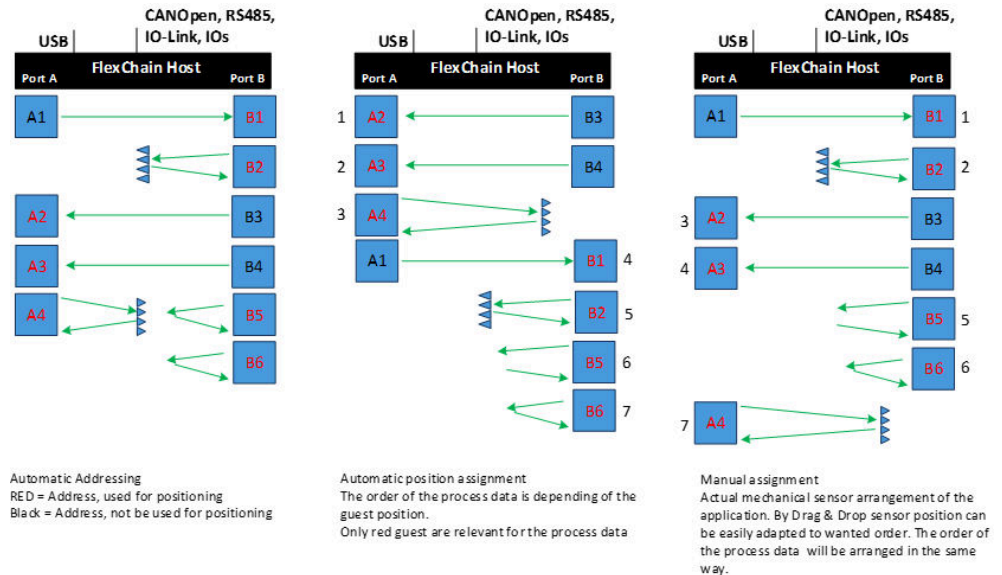

Figure 11: Manual positioning of guests

Using SOPAS, the position of a guest can be easily changed via drag & drop (figure 11). Note that the sequence number in the process data word also changes depending on the positioning.

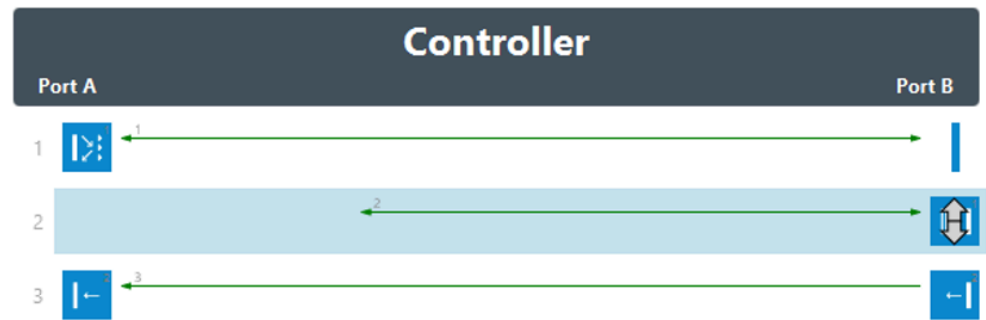

Figure 12: Manual positioning of guests

To ensure the correct guest has been selected, detailed information about the selected guest is shown on the right hand side. There is also a “Find Me” function for easily locating a guest. After selecting a specific guest and pressing the Find Me button, both LEDs on the selected guest flash with 1 Hz.



NOTE

- 1 Find Me can also be activated during process data operation (PD = valid). Note, however, that this will have a periodic effect (500 ms) on the cycle time.
- 2 The Find Me function is automatically deactivated by the device for certain commands/configurations (Factory reset, Teach-in, Confirm chain change, Automated assignment, Automated position assignment, Change position, or Teach-in position).

Guest setting

Guest position	5	Find me
Number of channels	1	
Channel spacing	0.0	
	Port A	Port B
Product name	GE6-CA021K00	GS6-CC021K00
Product text	FlexChain Through-beam Receiver	FlexChain Through-beam Sender
Order number	1098786	1098786
Part number	2104681	2104680
Firmware version	1.1.0	1.1.0
Serial number	18500001	18500004
Guest address	A 6	B 4
		<input type="checkbox"/> Cross beam <input type="button" value="Teach guest"/>

Figure 13: Manual positioning settings

7.1.4.1 Confirm chain change

The total number of connected guests and their respective threshold values are stored in the host. If the number of guests changes at a later time, a warning message is displayed. Confirm chain change is used to confirm the new total guest count and store it in the host. The warning message is no longer displayed.

7.1.4.2 Automated assignment

Automated assignment performs the three methods “Confirm Chain Change”, “Automated Position Assignment”, and “Automatic Zone Assignment” (see also the Zone tabs).

7.1.4.3 Teach

There are a number of different teach modes available.

- Teach all guests
Sets the switching threshold value for all centralized and teachable guests
- Teach guest
Sets the switching threshold value for the selected guest.
- Auto TeachIn
If AutoTeach is activated, a teach-in is carried out automatically after:
 - o Restart
 - o “Automatic Assignment”
 - o “Confirm Chain Change”
 - o IO-Link Datastorage Download

There are sensors (e.g. the photoelectric proximity sensor GTB6) where the switching threshold value can only be set manually directly on the sensor. A teach in via the host is not possible in this case.

The teach-in status should be queried after a teach-in. This returns a response for each individual guest position.

7.1.4.4 Performance Options

Performance options are available for a few guests. These are guest-specific setting options. The respective performance option can be found directly in the Teach menu (see figure 13).

Cross beam:

With the SLG-2 light grids, the “Cross beam” performance option can be selected to improve the resolution. The function is suitable for the detection of very flat and wide objects such as metal plates. This function enables the following resolution to be achieved between sender and receiver in the middle detection zone (average 50% of the total distance between sender and receiver):

Resolution = beam separation / 2 +4 mm

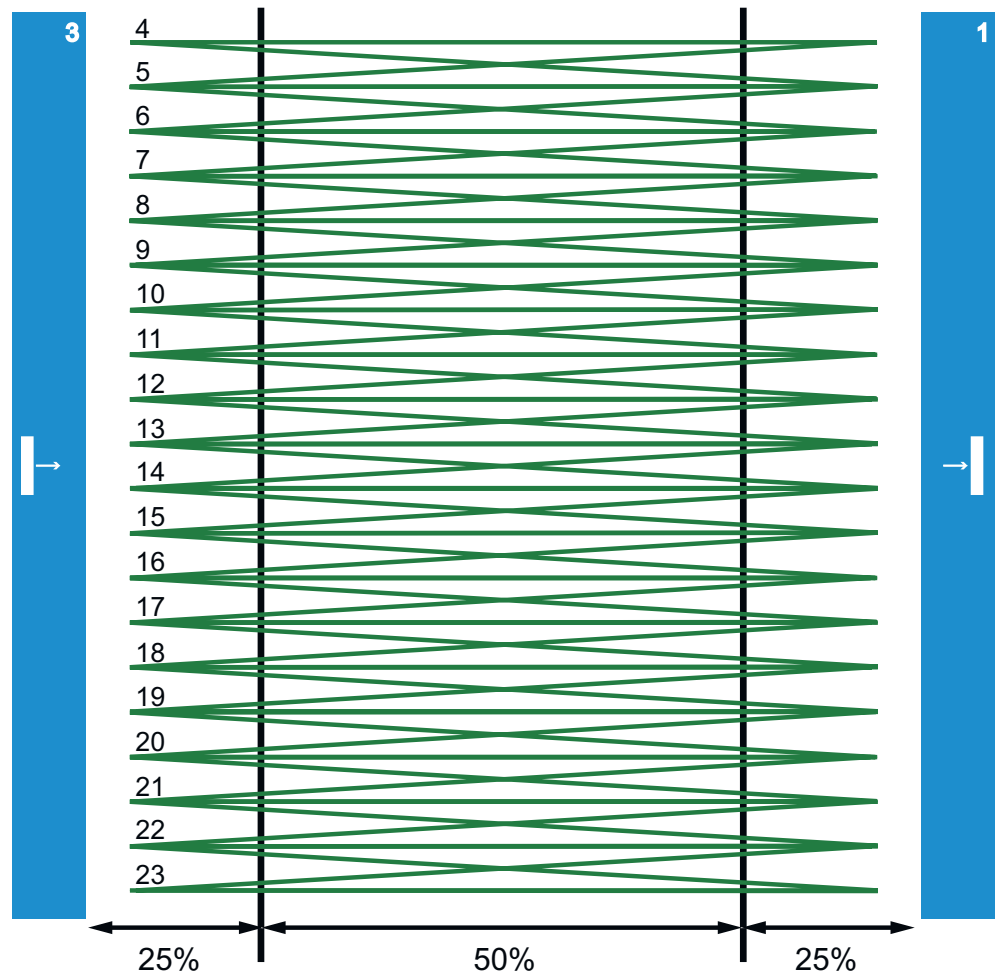

Figure 14: Cross beam, to improve the resolution in the middle 50%

7.1.4.5 Teach & Positioning IO-Link & CANopen Index



NOTE

Detailed information can be found in the IO-Link supplement (8023651) and/or the EDS description (8024673).

Table 4: Teach & Positioning IO-Link & CANopen Index

Object name	Description	IO-Link Index	CAN-Open Index
Standard Command/Automatic Guest Position Assignment	Performs automatic positioning of the guest positions	2	0x2,00 2
Standard Command/Automatic Assignment	Performs the Automatic Guest Position Assignment, Confirm Chain Change and Automatic Zone Assignment methods	2	0x2,00 2
Standard Command/Confirm Chain Change	Confirms/accepts and saves the new/existing number of guests in the host	2	0x2,00 2
Standard Command/Teach-In	Performs a teach-in across all sensors	2	0x2,00 2
Guest Teach-In Status	Indicates whether a teach-in is recommended by the system.	307	0x2,13 3

Object name	Description	IO-Link Index	CAN-Open Index
Guest positions	For manual positioning of the guests. Value range 1 – 32 for the guests with the addresses A1 – A32 (port A) and 101 – 132 for the guests with the addresses B1 – B32 (port B). Warning: senders should not be assigned a position, as senders do not have a channel.	304	0x2,13 0
Guest Performance Options	Adjustability of guest-specific options (e.g. cross beam)	305	0x2,13 1
Guest Teach-In Position	Teach-in of all guests or a selected specific guest	306	0x2,13 2
FindMe	During running, the guest(s) at the selected position flash at 1 Hz	204	0x20CC

IO-Link TeachInStatus has the following values:

- Teach-in necessary (0)
This is set if the guest at the relevant position has been replaced (serial number has changed), provided the guest is actually teachable, a teach-in has not already been carried out at that position, an Automatic assignment, Confirm chain change, Factory reset or DataStorage download has been performed.
- OK (1) (the last teach-in was successful)
- Fail (2) (the last teach-in failed, e.g. bad alignment)
This is an immediate teach-in response. It is also retained after a restart, and does not become a “Teach-in Necessary”.
- Local Adjustment at Device (optional) (3) (e.g., GTB with built-in potentiometer)
- Not Available (4) (guest does not have a teach-in function, for example a sender, or is completely masked (user mask))

7.1.5 Zones

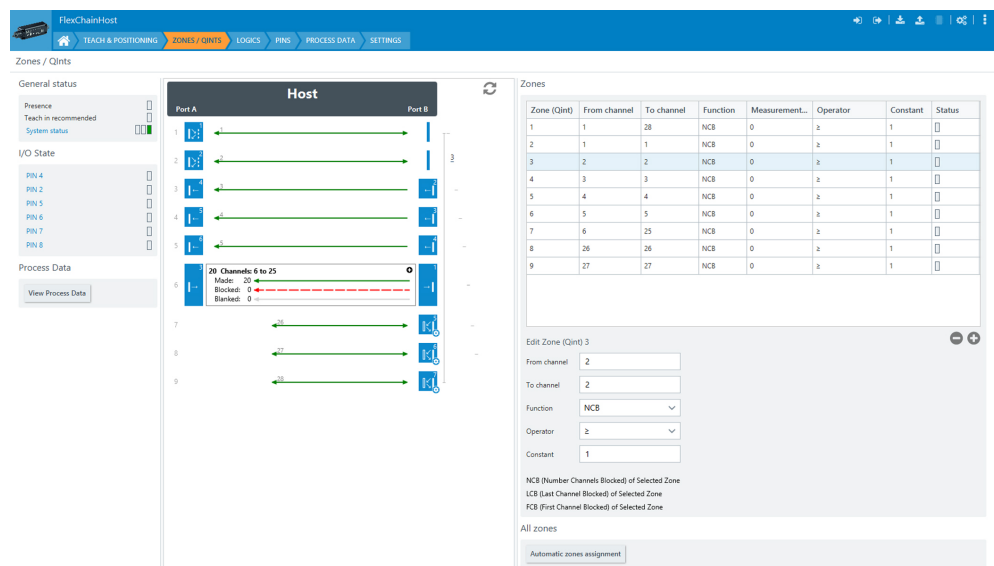

Figure 15: Zones

The Zones tab can be used to define multiple areas or zones. Up to 16 zones can be defined.

The zones are displayed, on the one hand, in a table on the right hand side. You can configure the zones there. The zones are also shown in the system schematic (on the left).

Specific measurement functions can be defined within each zone. The result is passed on as an internal output state, which in turn can be used as input for further functions, or directly outputted via an output. The measurement results of a zone can also be output via the serial interface (see "Process data", page 36).

7.1.5.1 Zone definition

Automated zone assignment

This function is performed by "Automatic Zone Assignment" or by "Auto Assignment". Starting with zone 2, running causes every guest in a zone to be assigned the $NCB \geq 1$ function (number of channels blocked greater than or equal to 1).

$NCB \geq 1$ means that if at least one channel in the zone is blocked, the internal output state is set to "High".

The exception to this is zone 1. It is initially defined as the first channel to the last channel.

Manual zone assignment

You can individually select each zone in the right hand area of the screen, and configure the zone in the bottom area. The "Status" column shows whether the internal output state Qint is active or not.

Zones

Zone (Qint)	From chan...	To channel	Function	Measurement value	Operator	Constant	Status
1	1	28	NCB	7	\geq	1	<input checked="" type="checkbox"/>
2	1	1	NCB	0	\geq	1	<input type="checkbox"/>
3	6	25	NCB	7	\geq	1	<input checked="" type="checkbox"/>

Figure 16: Overview of the settings for each zone

Edit Zone (Qint) 3

From channel

To channel

Function ▼

Operator ▼

Constant

Figure 17: Zone configuration options

The zone range can be set in the parameterization area (e.g., from Channel 3 – Channel 6). It is also possible to define different measurement functions within each zone. These include:

- 1 NCB: Number of channels blocked; object detection or width classification
 Example 1: $NCB \geq 1$ for object detection (Qint active if at least 1 channel blocked)
 Example 2: $NCB = 2$ for width classification (Qint active if exactly 2 channels in a zone are blocked)

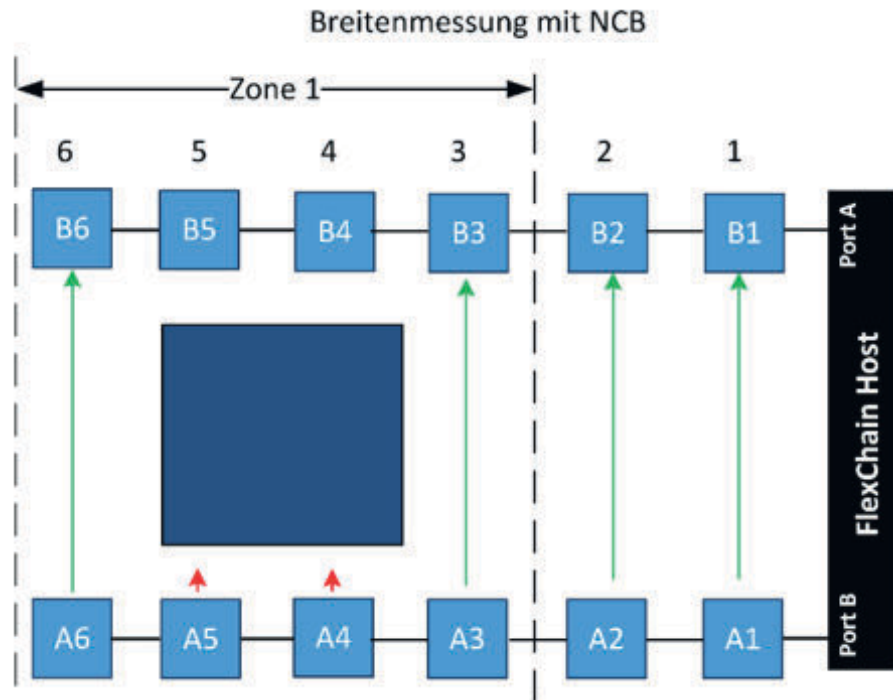

Figure 18: Width measurement with NCB

- 2 FCB/LCB: First channel blocked/last channel blocked:
 Mainly used for height measurement, height classification or position determination.
 - FCB: Channel number of the first blocked channel of a zone.
 - LCB: Channel number of the last blocked channel of a zone.

Example of height classification with FCB/LCB: Crates of the same size or larger than shown in the figure should be detected:

- $FCB \leq 5$: if the first channel blocked in zone 1 is channel 5 or lower, the internal output state Qint1 is activated (figure on left).
- $LCB \geq 2$: if the last channel blocked in zone 1 is channel 2 or higher, the internal output state Qint1 is activated (figure on right).

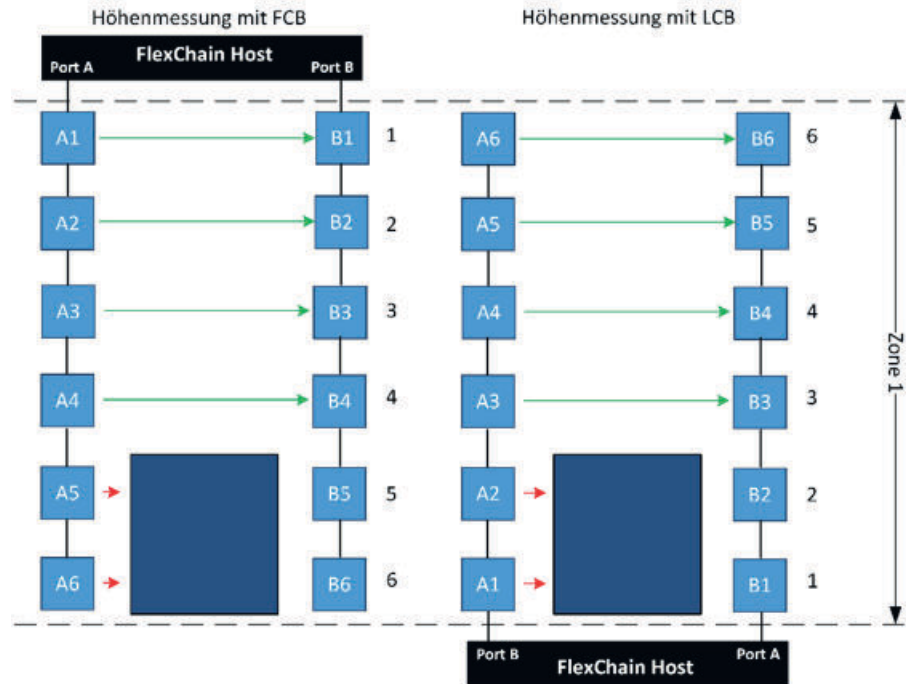

Figure 19: Height measurement FCB/LCB

7.1.5.2 Zones QInts IO-Link & CANopen Index



NOTE

Detailed information can be found in the IO-Link supplement (8023651) and/or the EDS description (8024673).

Table 5: Zones QInts IO-Link & CANopen Index

Object name	Description	IO-Link Index	CAN-Open Index
Standard Command/Automatic Zone Assignment	Performs an automatic zone definition and assigns the function $NCB \geq 1$ to each zone	2	0x2002
Standard Command/Automatic Assignment	Performs the Automatic Guest Position Assignment, Confirm Chain Change and Automatic Zone Assignment methods	2	0x2002

Object name	Description	IO-Link Index	CAN-Open Index
Qint Zone Definition 1-16	Zone definition with a start channel and an end channel	"Index = 351 + x*2; x = 0,1,2,... 15"	"Index = 0x215F + x*2; x=0,1,2,...,F"
Qint Advanced Settings 1-16	A measurement function with operator and constant can be defined. The result (Qint) is a boolean value	" Index = 352 + x*2; x = 0,1,2,... 15"	"Index = 0x2160 + x*2; x = 0,1,2,... F"

7.1.6 Logics

7.1.6.1 Logics tab

The Logic tab can be used to further process the individual Qint internal output states or external signals using logic functions (AND, OR,...). A total of 8 logics are available, whereby Logic x (n-x) (x>=1 and x<n) can also be used as an input signal for Logic n. The logic state can be outputted via the switching output or via the serial interface.

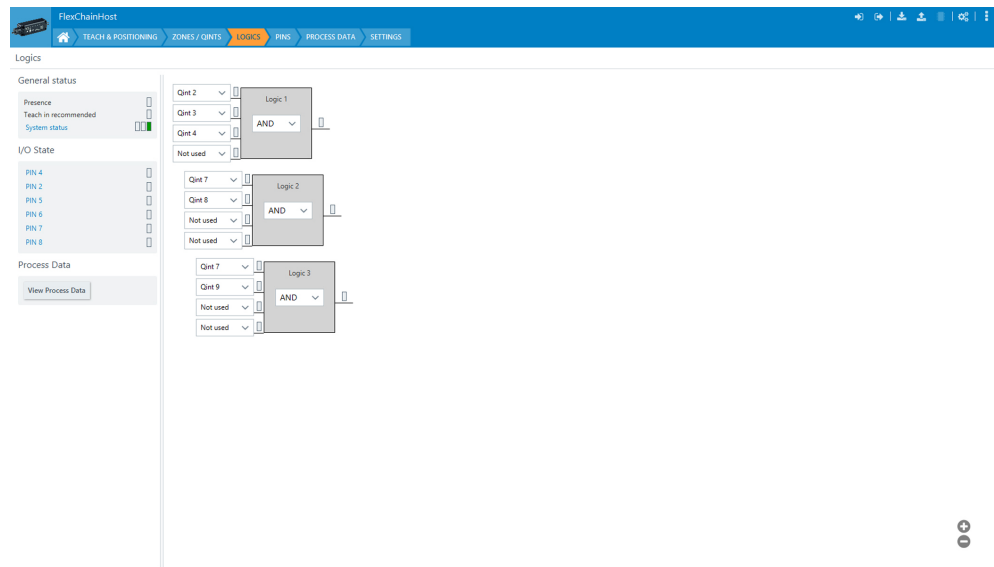

Figure 20: Logics tab with two logics

If all logic inputs of a gate are “Not Used”, the result will differ depending on the logic function selected. This fact can also be used to produce a constant 0 or 1.

Table 6: Logic functions

Logic function	Result
AND	1
OR	0
XOR	0
NAND	0
NOR	1
XNOR	1

An input that is “Not Used” is not actually removed but instead replaced with a value that does not change the result, i.e. 1 for AND and NAND, otherwise 0.

The XOR and XNOR function is not generally defined for more than two inputs.

The following definitions were selected for the FlexChain implementation:

Table 7: Inputs/outputs

Inputs				Outputs	
a ₀	a ₁	a ₂	a ₃	XOR	XNOR
0	0	0	0	0	1
0	0	0	1	1	0
0	0	1	0	1	0
0	0	1	1	0	1
0	1	0	0	1	0
0	1	0	1	0	1
0	1	1	0	0	1
0	1	1	1	1	0
1	0	0	0	1	0
1	0	0	1	0	1
1	0	1	0	0	1
1	0	1	1	1	0
1	1	0	0	0	1
1	1	0	1	1	0
1	1	1	0	1	0
1	1	1	1	0	1

7.1.6.2 Logics IO-Link & CANopen Index



NOTE

Detailed information can be found in the IO-Link supplement (8023651) and/or the EDS description (8024673).

Table 8: Logics IO-Link & CANopen Index

Object name	Description	IO-Link Index	CAN-Open Index
Logic 1-8	Configuration of logic gates 1 – 8. Selection of the operator and the logic inputs	421,422,423 ... 428	0x21A5 , 0x21A6 , 0x21A7 , ... 0x21AC

7.1.7 PINS

7.1.7.1 PINS tab

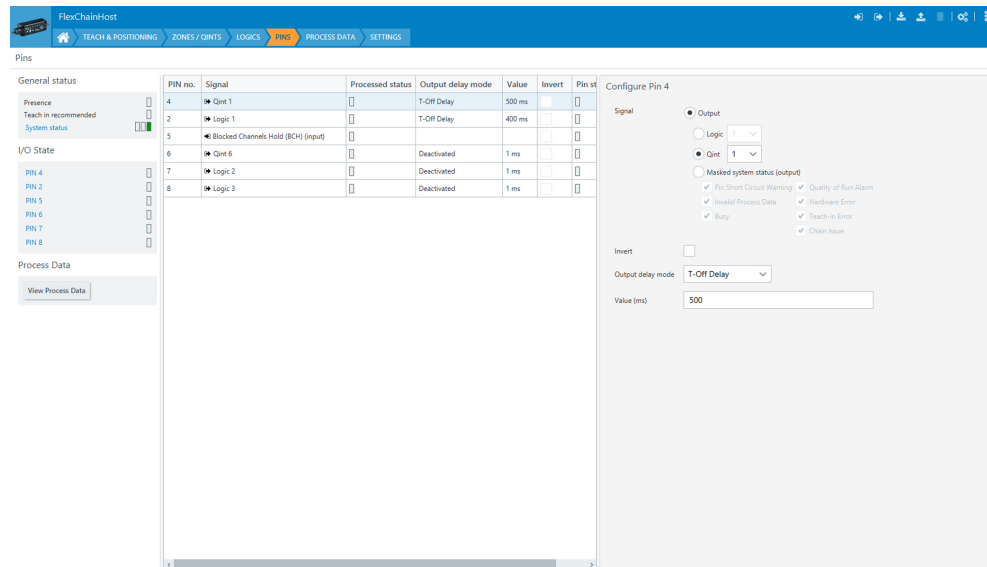

Figure 21: Pins

The PINS tab can be used to configure which information is assigned to, or should be output for a pin.

Possible output signals

- 1 Qint
Issues the Qint status of the zones
- 2 Logic
Issues the configured logics
- 3 Masked System Status
One system status byte. You can configure when, and for which warnings and error messages this signal should be high.

input

- 1 Teach-In Trigger
For performing an external teach-in.
- 2 Logic-In
The input signal can be used for the logics.
- 3 Blocked Channel Hold
If the input signal is 0 (“LOW”), the “Blocked Channel Hold” function is set. Channels that have been blocked once remain set or are held. Thus only a channel status from 0 to 1 is possible. If the input signal is 1 (“HIGH”), the “Block Channel Hold” function is inactive and the channel status indicates the currently measured values.
- 4 RS-485 Trigger
Sends data as soon as a signal is HIGH.
- 5 Sender Off
Test function for simulating object detection: The sender LEDs can be deactivated via the input. This can be used to test whether the associated receiver LED responds.

Furthermore, the temporal behavior of the PIN can be controlled via the “Output Delay Mode” and a possibility of signal inversion is available. A value range between 1 ms and 30,000 ms is available for the “Output Delay Mode” function.

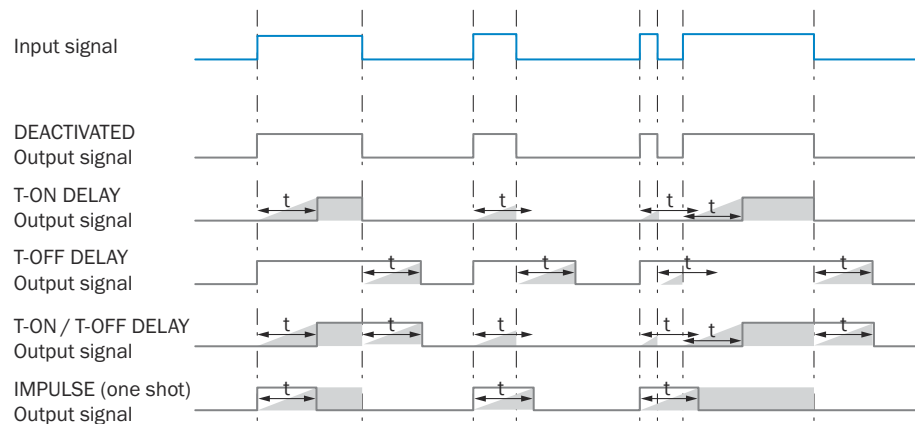

Figure 22: Output delay modes

7.1.7.2 PINS IO-Link & CANopen Index



NOTE

Detailed information can be found in the IO-Link supplement (8023651) and/or the EDS description (8024673).

Table 9: PINS IO-Link & CANopen Index

Object name	Description	IO-Link Index	CAN-Open Index
PIN 2 Configuration	Assign a boolean value like Qint 1 – 16, Logic 1 – 8, Teach-In Trigger...	121	0x2,079
PIN 4 configuration	Assign a boolean value like Qint 1 – 16, Logic 1 – 8, Teach-In Trigger...	441	0x21B9
PIN 5 configuration	Assign a boolean value like Qint 1 – 16, Logic 1 – 8, Teach-In Trigger...	122	-
PIN 6 configuration	Assign a boolean value like Qint 1 – 16, Logic 1 – 8, Teach-In Trigger...	442	-
PIN 7 configuration	Assign a boolean value like Qint 1 – 16, Logic 1 – 8, Teach-In Trigger...	443	-
PIN 8 configuration	Assign a boolean value like Qint 1 – 16, Logic 1 – 8, Teach-In Trigger...	444	-
Output Delay Mode Pin2/ Pin4	T-On Delay, T-Off Delay, ...	213/212	0x20D5 / 0x20D4
Output Delay Mode Pin5 / Pin6 / Pin7 / Pin8	T-On Delay, T-Off Delay, ...	463/465/467/469	-
Output Delay Time Pin2 / Pin4	Time value for the delay modes	215/214	0x20D7 / 0x20D6
Output Delay Time Pin5 / Pin6 / Pin7 / Pin8	Time value for the delay modes	464/466/468/470	-
Pin2 / Pin4 Inversion	Inverting the signal	455/456	0x21C7 / 0x21C8

Object name	Description	IO-Link Index	CAN-Open Index
Pin5 / Pin6 / Pin7 / Pin8 Inversion	Inverting the signal	457/458/459/460	-
Pin2 / Pin4 System Status Mask	Boolean value: ORing of different diagnostic information	447/448	0x21BF / 0x21C0
Pin5 / Pin6 / Pin7 / Pin8 System Status Mask	Boolean value: ORing of different diagnostic information	449/450/451/452	-

7.1.8 Process data

7.1.8.1 Process Data Tab

For the IO-Link and CANopen interfaces, the FlexChain process data word has a length of 32 bytes. Each of these bytes can be individually populated with the desired data.

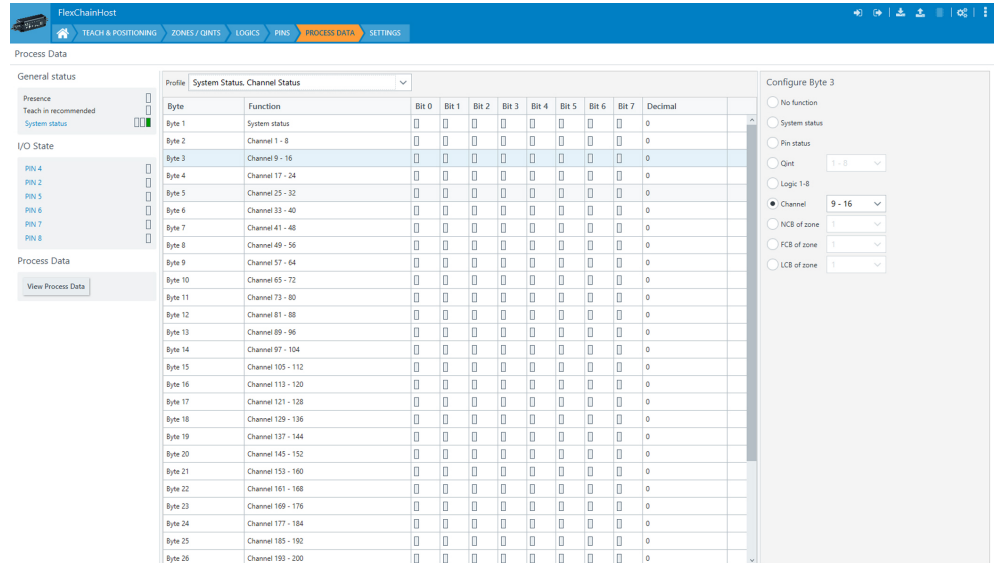

Figure 23: Overview of process data

Loading process data via profiles

A number of pre-defined process data profiles are available that can be selected to populate the process data word.

Profile					Bit 4	Bit
	System Status, Channel Status					
Byte	System Status, Channel Status					
Byte 1	Channel Status				<input type="checkbox"/>	<input type="checkbox"/>
Byte 2	System Status, Qint 1-8, Qint 9-16, Logic 1-8, Pin Status				<input type="checkbox"/>	<input type="checkbox"/>
Byte 3	System Status, NCB of Zones, Pin Status				<input type="checkbox"/>	<input type="checkbox"/>
Byte 4	System Status, FCB of Zones, Pin Status				<input type="checkbox"/>	<input type="checkbox"/>
Byte 5	System Status, LCB of Zones, Pin Status				<input type="checkbox"/>	<input type="checkbox"/>
Byte 6	Empty				<input type="checkbox"/>	<input type="checkbox"/>
Byte 7	User defined				<input type="checkbox"/>	<input type="checkbox"/>
Byte 8	Channel 49 - 56	<input type="checkbox"/>	<input type="checkbox"/>	<input type="checkbox"/>	<input type="checkbox"/>	<input type="checkbox"/>
Byte 9	Channel 57 - 64	<input type="checkbox"/>	<input type="checkbox"/>	<input type="checkbox"/>	<input type="checkbox"/>	<input type="checkbox"/>

Figure 24: Loading process data via a profile

Manually customizing the process data

Each individual byte of the process data can be customized. After clicking on a byte, a drop-down list of information that can be assigned to the byte is displayed. The length of each “information block” is limited to one byte (8 bits). A single byte can therefore be used, for example, to transmit 8 channel states.

The available information is shown in figure 14. NCB, FCB and LCB are the actual measured values. For example, NCB transmits how many channels in the zone are blocked. The following assignment is defined for the issue of the outputs (PIN status):

Table 10: Assignment of the PIN status in the process data

PIN	4-2-5-6-7-8
BIT	0-1-2-3-4-5

Figure 25: Process data word selection

7.1.8.2 Process Data IO-Link & CANopen Index



NOTE

Detailed information can be found in the IO-Link supplement (8023651) and/or the EDS description (8024673).

Table 11: Process Data IO-Link & CANopen Index

Object name	Description	IO-Link Index	CAN-Open Index
Process Data Definition	Configuration of the process data. Each process data slot with a size of 8 bits can be assigned a process data function	67	"Cyclic data (process data)", page 45

7.1.9 Settings

7.1.9.1 Settings tab

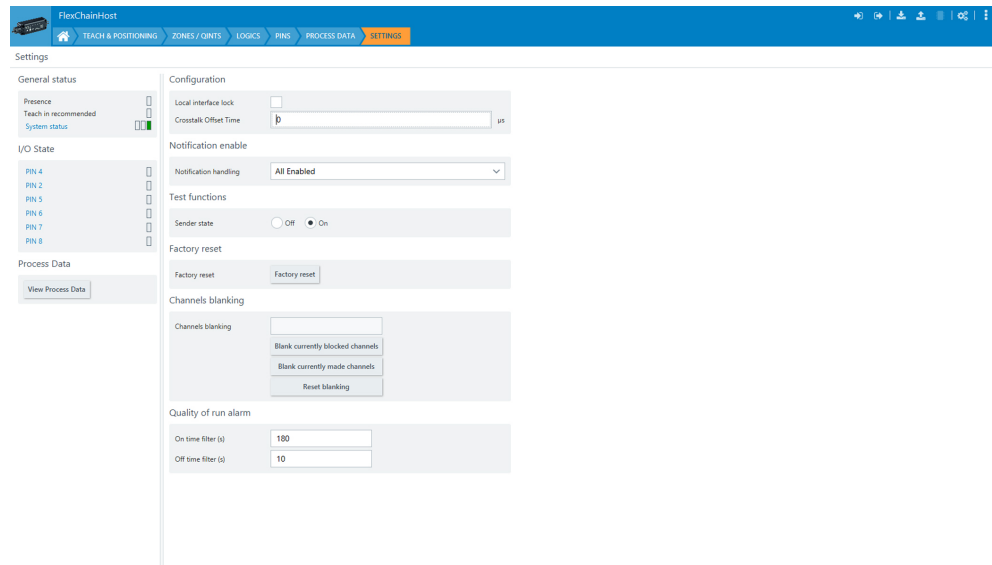

Figure 26: Settings tab

The following settings can be configured in the Settings tab:

- 1 Local interface lock: Locks the buttons on the display
- 2 Crosstalk Offset Time: If two identical FlexChain systems are operated in close proximity to one another, there is a possibility of mutual interference. The Crosstalk Offset Time changes the cycle time of the FlexChain system. The two systems can then no longer interfere with one another due to the different cycle time and the standard 2-bit processing.
Suitable crosstalk offset time values are 300 μ s and 500 μ s.
If these values do not work, a suitable value must be determined together with your technical contact.
- 3 “Notification handling” can be used to activate or deactivate events. Various events such as overtemperature, overvoltage, etc. can be selected. PDInvalid means invalid process data.
- 4 Test functions: Deactivates the sender LED. This is used to check whether the receiver is responding.
- 5 Factory reset: Restores all settings to the factory defaults. If there are guests connected to the system, these need to be reassigned using “Automated assignment”, and then taught in again using “Teach all devices”.
- 6 Blanked channels: The “blank all currently made/blocked channels” functions can be used to hide all free or currently blocked beams. This function is useful if there is a static object in the light path (e.g., light grid). The channels can also be individually hidden using Ctrl & left mouse button. Channels that are hidden are no longer included in the process data.
- 7 Quality of Run Alarm Time Filter: The filter can be used to select the time from which the “Quality of run alarm” signal becomes active. If the time is set very short, activation is possible if an object is in the light path. Since the signal is mainly used to detect contamination, a time filter of several minutes is usually sufficient.

7.1.9.2 Settings IO-Link & CANopen Index

**NOTE**

Detailed information can be found in the IO-Link supplement (8023651) and/or the EDS description (8024673).

Table 12: Settings IO-Link & CANopen Index

Object name	Description	IO-Link Index	CAN-Open Index
Local Interface Lock	Locks the operating pushbuttons of the FlexChain Host	4	0x200C
CrossTalkOffsetTime	If two identical FlexChain systems are operated directly next to each other, crosstalk may occur under certain circumstances. Two scans are always made for greater robustness. Crosstalk can be avoided if one system has a different ScanTime than another system. This is ensured by the offset time.	499	0x21F3
Notification Handling	Activate/deactivate IO-Link events and the ProcessStatus bits (event codes on the last page of the IO-Link supplement)	227	-
SenderOff	Test function: Deactivates the senders to simulate an blocking of the channels	97	0x2,061
Factory Reset	Resets the host to factory settings	2	0x2,002
Blank All Currently Made Channels	Blanks out all non-blocked channels. The blanked channels will not be taken into account in the evaluation.	2	0x2,002
Blank All Currently Blocked Channels	Blanks out all blocked channels. The blanked channels will not be taken into account in the evaluation.	2	0x2,002
Channel Mask	Individual blanking of individual channels. The blanked channels will not be taken into account in the evaluation.	72	0x2,048
Quality Of Run Alarm On Time Filter	Setting a warning after a critical signal strength is detected at the sensor for the defined duration	311	0x2,137
Quality Of Run Alarm Off Time Filter	Resetting a warning after an uncritical signal strength is detected at the sensor for the defined duration	312	0x2,138
Hardware Variant	Reading the connected hardware variant of the FlexChain Host	440	-
CANopen Node ID	Setting the Node ID	475	"Node ID and baud rate", page 43
CANopen Bit Rate	Setting the transmission rate	440	"Node ID and baud rate", page 43
RS-485 configuration	Parameterization of the RS-485 interface (baud rate, transmission format, ...	473	-

7.2 IO-Link specific settings

The FlexChain Host variants have an IO-Link interface. The process data can be retrieved via the interface and the system can be configured with the same range of functions as in Sopas using the service data.

Configuration via acyclic service data

Functions such as zone definition, teach-in or positioning can be carried out using the service data. The indices of the service data can be found in the IO-Link supplement. The IO-Link supplement for the respective product number can be found online. Various diagnostic information can be transferred via the process data.



NOTE

Detailed information can be found in the IO-Link supplement (8023651) and/or the EDS description (8024673).

Data Storage

All relevant parameters of the FlexChain Host can be saved in an IO-Link master using the data storage IO-Link function. If the device is replaced, these parameters can be written to the new device, or they can be distributed to multiple FlexChain Hosts with the same application.



NOTE

The device replacement via the IO-Link function data storage is only possible with a FlexChain Host with the same part number.



NOTE

After a DataStorage download, a changed number of guests and guest arrangement is automatically accepted. In addition, the teach-in status is reset at all guest positions. This means that a teach-in is necessary (if a teach-in is supported by the host at the corresponding guest). If an auto teach-in is set, the teach-in is carried out automatically on restart.

Issue of process data of the FlexChain Host

Transmission data

- Minimum cycle time IO-Link: 2.3 ms
- Baud rate: COM3 (230.4 kbaud)
- Process data length: 32 bytes
- IO-Link version: 1.1.0

7.3 CANopen-specific settings

7.3.1 Overview

Communication profile

The CANopen communication profile (documented in CiA DS-301) regulates how the devices in a CANopen network exchange data.

CANopen in the OSI model

The CANopen protocol is a standardized Layer 7 protocol for the CAN bus. This layer is based on the CAN Application Layer (CAL).

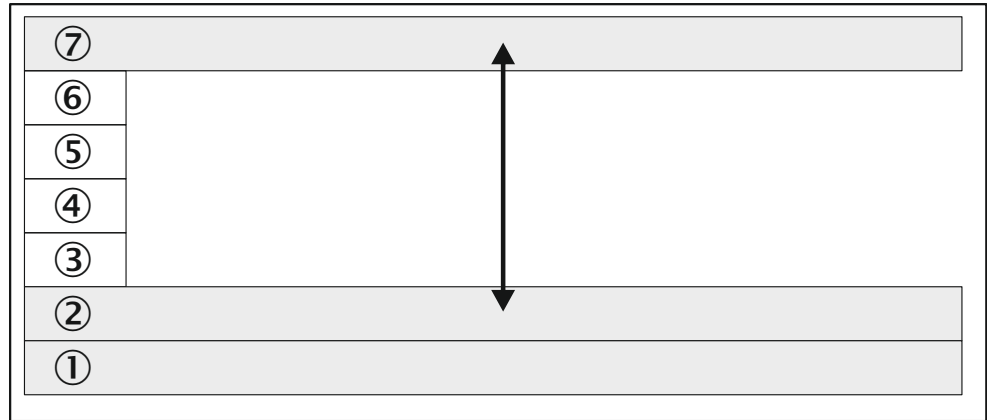

Figure 27: CANopen in the OSI model

- ⑦ CAN application layer
- ② Data link layer
- ① Physical layer



NOTE

Layers 3 to 6 are not used in CANopen.

Architecture

CANopen is an asynchronous, serial fieldbus. As a rule, all subscribers are connected in a line (line topology). Signals lines and star-shaped placement are permissible but this is not always possible.

The fieldbus needs to be terminated at the beginning and at the end of the bus field. A passive 120 Ω bus terminating resistor is sufficient for this. The simplest type of bus termination are male cable connectors with terminators (SICK part no. 6021167). A T-connector (SICK part no.: 6030664) is required to integrate the FlexChain in a CANopen network (except as end device).

The fieldbus can be expanded with bridges and repeaters.

The optional voltage supply to pin 2 is not supported.

Communication channels and status

CANopen features various communication channels (SDO, PDO, Emergency Messages). These channels are formed with the help of the communication object identifier (COB ID). The COB IDs are based on the node IDs of the individual devices on the CANopen bus.

As soon as the FlexChain Host possesses a node ID, it can be addressed via the network management services (NMT) and its CANopen state machine can be switched to the necessary status (Pre-Operational, Operational, or Stopped) by the master.

Network management

Network management (NMT) initializes the nodes in a CANopen network. It also adds the nodes to the network, as well as stopping and monitoring them.

The following statuses can be identified:

Table 13: Status of the CANopen state machine

Status	Description
Initializing	Initialization commences. Both the device application and device communication are initialized. After this, the node automatically switches to Pre-Operational status.
Pre-Operational	The FlexChain Host is ready for configuration; acyclic communication can take place via SDO. However, the FlexChain is not yet able to commence PDO communication and is not sending out any emergency messages.
Operational	In this state, the FlexChain is fully ready for operation and can transmit messages autonomously (PDOs, emergency messages).
Stopped	In this state, the FlexChain is not actively communicating (although communication is still being actively monitored via node guarding).

7.3.1.1 Node ID and baud rate

Node ID

There can be a maximum of 128 devices on a CANopen network: one master and up to 127 slaves. Every device has a unique node ID (node address). The COB IDs (communication object identifiers) of the communication channels are derived from this ID.

A correct node ID must be set for the FlexChain on the display or membrane keyboard for communication with the master. The following are correct:

- A node ID which is free in the CANopen network
- A node ID which the master expects

Node ID 6 is set in the FlexChain at the factory.

Node IDs 1 to 127 can be set (0 is typically allocated to the master).

Baud rate

The same baud rate must be set on the FlexChain as in the master.

The higher the baud rate used in the CANopen network is, the lower the bus load. The longer the lengths of cable used are, the lower the possible baud rate.

Baud rate 125 kbit/s is set at the factory.

The following baud rates can be assigned to the FlexChain: 10 kbit/s, 20 kbit/s, 50 kbit/s, 125 kbit/s, 250 kbit/s, 500 kbit/s, 800 kbit/s, 1,000 kbit/s.

Maximum length of cable

The max. length of the cable within a business field depends on the baud rate. The table below shows the sensing range per business field without the use of repeaters.

Table 14: Maximum length of cable

Baud rate	125 kbit/s	250 kbit/s	500 kbit/s	1,000 kbit/s
Length of cable	500 m	250 m	100 m	30 m

7.3.1.2 Setting of node ID and baud rate

Set the node ID and the baud rate as follows:

- Using the display or membrane keypad
- Via SOPAS ET
- Via layer setting services (LSS)

**NOTE**

The voltage supply of the FlexChain must be switched off then back on to activate the baud rate.

A device reset (command 81) is sufficient to activate a changed node ID.

SOPAS ET

The node ID and the baud rate of the FlexChain can also be set via SOPAS ET.

In the **address configuration** area, you can enter the **address** in CAN and select the **baud rate**. You can enter address 1 to 127 for the FlexChain.

The screenshot shows a configuration window titled 'CANopen'. It contains two input fields: 'Node ID' with the value '6' and 'Baudrate' with a dropdown menu set to '125 kBits/s'.

Figure 28: Node ID and baud rate in SOPAS ET

Access via layer setting services

Layer setting services are supported in order to set the node ID and the baud rate of the FlexChain.

The LSS slave is accessed via its LSS address (identity object), which is stored in object 1018h. The LSS address comprises:

- Vendor- ID
- Product-Code
- Revision number
- Serial number

The master uses the LSS services to request the individual services which are then executed by the FlexChain. The LSS telegrams facilitate communication between LSS master and LSS slave. An LSS telegram is always 8 bytes long. Byte 0 contains the command specifier (CS), followed by 7 bytes for the data. All bytes that are not in use must be set to zero.

The following COB IDs are used:

- 07E4h = LSS slave to LSS master
- 07E5h = LSS master to LSS slave

7.3.1.3 Configuration using an EDS file

An EDS file is available for easy connection of the FlexChain to a CANopen master. Among other things, this file contains the default parameters of the FlexChain and the default configuration for the process data.

You can download the EDS file at www.sick.com:

1. Enter the seven-digit part number of your FlexChain directly into the **Search** field on the homepage.
2. Click on the relevant search result.
- ✓ This will take you to all the information and files for your device.
3. Download the EDS file.
4. Integrate the EDS file into the engineering tool of your control.

When the FlexChain is integrated into the CANopen development environment, the object values can be read out and set using the engineering tool.

7.3.2 Acyclic data (service data)

The service data forms the communication channel through which device parameters (e.g. configuration of the beam numbering) are transmitted. It is used for status queries.

Service data is always transmitted with confirmation, i.e. the receipt of every message is acknowledged by the receiver.

The FlexChain has a Transmit service data channel and a Receive service data channel, to which two CAN identifiers are assigned.

The service data communication corresponds to the client-server model. The FlexChain functions as an SDO server. In its request, the SDO client (e.g., the PLC) specifies the parameter, the access method (read/write), and the value, if applicable. The FlexChain executes read/write access and responds to the request.

The maximum data length of a CAN telegram of 8 bytes is assigned as follows:

Table 15: Service data format

COB-ID	CCD	Index		Subindex	Specifications			
600 h + node ID	Byte 0	Byte 1	Byte 2	Byte 3	Byte 4	Byte 5	Byte 6	Byte 7

The command code (CCD) identifies whether read or write access is required. In the event of an error, the data range will contain a 4-byte error code which provides information about the cause of the error.



NOTE

All parameters are automatically saved immediately after writing. Only the mapping of the PDOs is not saved and must be reinitialized after every device restart.

7.3.3 Cyclic data (process data)

Process data is used for rapid and efficient exchange of real-time data (e.g., I/O data, setpoint values or actual values).

8 databytes are available for the transmission of process data. Process data is transmitted without confirmation.

Table 16: Process data format

COB-ID	Specifications							
0,180 h + node ID	Byte 0	Byte 1	Byte 2	Byte 3	Byte 4	Byte 5	Byte 6	Byte 7

The FlexChain supports 6 Transmit PDOs and 1 Receive PDOs.

Data from the FlexChain is sent to the master with the Transmit PDOs.

The Transmit PDOs are defined by the following objects:

- Objects 1,800 h to 1,805 h contain the communication parameters.
- Objects 1A00 h to 1A05 h contain the object mapping.

The format of the Transmit PDO between the master and the FlexChain must be agreed through PDO mapping.

The process data can be arranged at will. The address (i.e. index and subindex) and the size (number of bits) from the entry in the object directory are entered in the mapping object for this purpose.

Bus load

- The more process data and the more frequently it is sent, the higher the bus load in the CANopen network.
- The higher the baud rate used in the CANopen network is, the lower the bus load.
- The longer the lengths of cable used are, the lower the possible baud rate.

A compromise must therefore be found between all three named factors for optimal communication.

**NOTE**

If a Transmit PDO is not used, it should be deactivated. To do so, set bit 31 to 1 in subindex 01h of the respective object 180xh.

7.3.4 Object library

Table 17: Nomenclature for access and data types

Abbreviation	Meaning
R	Read only access
R/W	Read/write access
STRG	String = a chain of characters of varying length
BOOL	Boolean = logical value 0 or 1
ENUM	Freely selectable values with a limited value range (e.g. BLACK, RED, BLUE, YELLOW)
UINT	Unsigned Integer = whole number value (e.g. UINT-32 = 0 ... 4.294.967.295)
ARRAY	Data sequence of a data type (e.g. Array UINT-8 = character string of the data type UINT-8)
RECORD	Sequence of data containing different data types (e.g. UINT-8, UINT-32, UINT-32, UINT-16)
STRUCT	Sequence of data containing different data types (e.g. UINT-8, UINT-32, UINT-32, UINT-16)

Table 18: Standard objects

Object	Access	Data type	Name
1,000 h	R	UINT-32	Device type
1,001 h	R	UINT-8	Error Register
1,005 h	R/W	UINT-32	COB-ID SYNC message
1,008 h	R	STRG	Device name
1,009 h	R	STRG	Hardware version number
100 Ah	R	STRG	Software version number
100 Ch	R/W	UINT-16	Node guarding - Guard time
100 Dh	R/W	UINT-8	Node guarding - Life time factor
1,014 h	R/W	UINT-32	COB-ID emergency message
1,015 h	R/W	UINT-16	Emcy inhibition time
1,016 h	R/W	UINT-32	Consumer heartbeat time
1,017 h	R/W	UINT-16	Producer heartbeat time
1,018 h	R	RECORD	Identity Object
1,400 h ... 1,401 h	R/W	RECORD	Receive PDO - Communication
1,600 h ... 1,601 h	R/W	RECORD	Receive PDO - Mapping
1,800 h ... 1,805 h	R/W	RECORD	Transmit PDOs - Communication

Object	Access	Data type	Name
1A00 h ... 1A05 h	R	RECORD	Transmit PDOs – Mapping

7.3.5 1xxxh – Standard objects

CANopen standard objects are implemented in the FlexChain.

7.3.5.1 Device type

1,000 h - Device type

Table 19: 1000h – Device type

Object	Access	Data type	Description
1000h	R	UINT-32	The object contains the device type. The value is always 0, as no device profile is defined for the measuring automation light grid.

7.3.5.2 Error register

1001h – Error register

Table 20: 1001h – Error register

Object	Access	Data type	Description
1001h	R	UINT-8	The object contains the error register.

The error register is stored in 8 bit:

Table 21: Error register – Stored in 8 bit

Bit 7	Bit 6	Bit 5	Bit 4	Bit 3	Bit 2	Bit 1	Bit 0
Manufacturer-specific error	Reserved	Device profile-related error	Communication error	Temperature error	Voltage error	Current error	Generic error

7.3.5.3 SYNC message

1,005 h – COB-ID SYNC message

Table 22: 1,005 h – COB-ID SYNC message

Object	Access	Data type	Description
1,005 h	R/W	UINT-32	Determines whether the device generates the SYNC message and if it does, which bit width is used.

Table 23: 1,005 h – Details

Bit	Description	Data values
31	Reserved	0
30	Determines whether the device generates the SYNC message.	0 Device does not generate a SYNC message. 1 Not supported
29	Determines which bit width is used.	0 11 bit 1 Not supported
28 ... 0	29 bit wide CAN-ID	0
11 ... 0	11 bit wide CAN-ID	80 h

7.3.5.4 Type code

1,008 h – Device name

Table 24: 1,008 h – Device name

Object	Access	Data type	Description
1,008 h	R	STRG	The object contains the type code.

7.3.5.5 Hardware version

1,009 h – Hardware version number

Table 25: 1,009 h – Hardware version number

Object	Access	Data type	Description
1,009 h	R	STRG	This object contains the revision status of the hardware.

7.3.5.6 firmware version

100 Ah – Software version number

Table 26: 100 Ah – Software version number

Object	Access	Data type	Description
100 Ah	R	STRG	This object contains the version of the firm-ware.

The version of firmware in its delivery state can be found on the type label.

7.3.5.7 Node guarding

The node guarding telegram is sent to poll the status of the FlexChain at regular intervals. The monitoring time multiplied by the life time factor results in the cycle in which the FlexChain is monitored.

100 Ch – Guard time

Table 27: 100 Ch - Node guarding – Guard time

Object	Access	Data type	Description
100 Ch	R/W	UINT-16	Configured monitoring time in ms

100 Dh – Life time factor

Table 28: 100 Dh - Node guarding – Life time factor

Object	Access	Data type	Description
100 Dh	R/W	UINT-8	Factor for multiplication of the monitoring time

7.3.5.8 COB-ID of the emergency message

1,014 h – COB-ID emergency message

Table 29: 1,014 h – COB-ID emergency message

Object	Access	Data type	Description
1,014 h	R/W	UINT-32	Communication object identifier of the emergency message The value is calculated from 00000080 h + node ID 1 ... 127. Example: the FlexChain with factory-set node ID = 6 transmitted with COB-ID 00000086 h.

If the FlexChain detects an internal error, it sends an emergency message.

The FlexChain supports the following emergency messages:

Table 30: Emergency messages

Error code of object 1,003 h	Error register of object 1,001 h	Manufacturer-specific code					Description
		1	2	3	4	5	
0,000 h	00 h	0	0	0	0	0	No error or reset error
6,180 h	11 h	0	0	0	0	0	The PDO mapping specified in the FBMD file is faulty or there are not enough PDO services available. All PDOs of this direction are locked.
6,380 h	11 h	0	0	0	0	0	A CANopen object has been mapped in several Receive PDOs. No process data is sent to the application controller.
8,110 h	11 h	1	0	0	0	0	CAN overrun The receipt buffer in the CAN controller is full. New messages cannot be saved and are lost.
8,110 h	11 h	2	0	0	0	0	CAN overrun The sender buffer in the CAN controller is full. New messages cannot be sent. The FlexChain CANopen tries to send an emergency message when the cause is not a busoff or ERROR PASSIVE.
8,120 h	11 h	0	0	0	0	0	The CAN controller switches to ERROR PASSIVE status.
8,130 h	11 h	ID ¹	0	0	0	0	The heartbeat or node guarding of a CANopen device to be monitored has failed.
8,140 h	11 h	0	0	0	0	0	It was possible to restart the CANopen communication after a busoff. Data can be lost.
8,210 h	11 h	No. ²	0	0	0	0	PDO too short The Receive PDO contains too little data. The data is ignored.
8,220 h	11 h	No. ²	0	0	0	0	PDO too long The Receive PDO contains too much data. The redundant data is ignored.

¹ Node ID of the failed device.

² Object number of the affected PDO.

7.3.5.9 Inhibition time for emergency message

1,015 h – Emergency inhibition time

Table 31: 1,015 h – Emergency inhibition time

Object	Access	Data type	Description
1,015 h	R/W	UINT-16	The configured inhibition time for the emergency message in ms. The inhibition time becomes inactive with value 0.

7.3.5.10 Heartbeat

The FlexChain can be monitored with the heartbeat protocol or monitor other bus nodes.

1,016 h – Consumer heartbeat time

Table 32: 1,016 h – Consumer heartbeat time

Object Subindex	Access	Data type	Description
1,016 h	R/W	UINT-16	Cycle time of the heartbeat in ms. The heartbeat becomes inactive with value 0.
00 h	R/W	UINT-8	Number of entries
01 h	R/W	UINT-32	Node ID and heart beat time of the monitored bus node (see table 33)

Table 33: 1,016 h – Details

Bit	Description
31 ... 24	Reserved
23 ... 16	Node ID of the monitored bus node
15 ... 0	Heartbeat time of the monitored bus node (typically multiplied by a factor of 1.5)

1,017 h – Producer heartbeat time

Table 34: 1,017 h – Producer heartbeat time

Object	Access	Data type	Description
1,017 h	R/W	UINT-16	Cycle time of the heartbeat in ms. The heartbeat becomes inactive with value 0.

7.3.5.11 Identification values of the FlexChain**1,018 h – Identity object**

Table 35: 1,018 h – Identity object

Object	Access	Data type	Description
1,018 h	R	RECORD	You use this object to read the following values from the FlexChain: Subindex 01 h = Vendor ID (SICK AG) Subindex 02 h = Product Code Subindex 03 h = Revision Number (firmware version) Subindex 04 h = Serial Number (serial number)

7.3.6 Standard object for defining process data

The FlexChain supports 6 Transmit PDOs and 1 Receive PDOs. Each Process Data Object (PDO) has one communication object and one mapping object.

Communication objects specify which COB IDs are used and which transmission type is selected for this.

The mapping objects specify which objects are sent as process data.

The Transmit PDOs are defined by the following objects:

- Objects 1,800 h to 1,805 h contain the communication parameters.
- Objects 1A00 h to 1A05 h contain the object mapping.

The Receive PDOs are defined by the following objects:

- The object 1,400 h contains the communication parameters.
- The object 1,600 h contains the object mapping.

While parameters are being changed, no process data is available.

Transmission types

The “Transmission type” parameter (subindex 02 h of all PDOs) contains information on when a Transmit PDO is sent or how Receive PDOs received are handled.

Table 36: Transmission types

Transmission Type	Transmission type				
	Cyclic	Acyclical	Synchronous	Asynchronous	RTR
0	-	X	X	-	-
1-240	X	-	X	-	-
241-251	Reserved				
252	-	-	X	-	X
253	-	-	-	X	X
254 +255	-	-	-	X	-

Transmission type 0: Acyclical and synchronous data transmission

During acyclical and synchronous data transmission, only one Transmit PDO is sent if the FlexChain receives a SYNC message and the beam status of the FlexChain has changed.

For an Receive PDO, this transmission type means that the data received is evaluated only after receiving the next SYNC message.

Transmission type 1 to 240: Cyclical and synchronous data transmission

With synchronous and cyclical data transmission, a Transmit PDO is not sent until after a certain number of SYNC message have been received. This number may be between 1 and 240. A Receive PDO is processed after the reception of the next SYNC message.

Transmission type 252 and 253: RTR data transmission



NOTE

Transmission types 252 and 253 are only permissible for Transmit PDOs.

Some bus module manufacturers do not support RTR data transmission. For this reason, we do not recommend using transmission types 252 and 253.

RTR stands for “Remote Transmission Request”. With RTR data transmission, data is only transferred after an RTR frame has been received.

With synchronous RTR data transmission (transmission type 252), the process data is redetermined every time a SYNC message is received. A Transmit PDO is not transmitted until the RTR frame has been received.

With asynchronous RTR data transmission (transmission type 253), the current values are constantly determined. A Transmit PDO is not transmitted until the RTR frame has been received.

Transmission type 254 + 255: Asynchronous data transmission

In asynchronous data transmission, Transmit PDOs are transmitted in an event-controlled process. This means transmission occurs every time the beam status of the FlexChain changes.

A Receive PDO is evaluated immediately after it is received.

This transmission type can be linked with the event timer.

Dynamic PDO mapping

Mapping objects are used to define which parameters and data are to be used. In the mapping object, links are created to objects from the object directory. Objects linked in the mapping object are sent in Process Data Objects (PDOs).

Subindex 00 h for a mapping object specifies the number of linked objects. If a new object is linked, the device tests the validity of the link. If the linked object is not available or cannot be linked, an error message will be triggered.



NOTE

The dynamic PDO mapping is permanently saved in the FlexChain.

7.3.6.1 Communication parameter of the Receive PDO

1,400 h – Communication parameter of the Receive PDO

Table 37: 1,400 h

Object Subindex	Access	Data type	Description	
1,400 h	R/W	RECORD	Communication parameter of the Receive PDOs	
00 h	R	UINT-8	Number of entries	
01 h	R/W	UINT-32	Bit	Description
			31	0: PDO is being used 1: PDO is not being used
			30	0: reacts to RTR 1: does not react to RTR
			29	0: 11 bit identifier (CAN 2.0A) 1: 29 bit identifier (CAN 2.0B)
			28 ... 0	COB-ID = 0200h + node ID
02 h	R/W	UINT-8	Transmission Type	Description
			0	Data is synchronized, but not cyclically sent
			1 ... 240	Cyclic transmission Clocked with the SYNC messages
			252	Query by the RTR telegram (synchronous transmission)
			253	Query by the RTR telegram (asynchronous transmission)
			254 +255	Event-controlled transmission when beam status changes
03 h	R/W	UINT-16	Inhibition time = Idle time between two transmissions (× 0.1 ms)	
04 h	-	-	Reserved	
05h	R/W	UINT-16	Event timer = Timer for application-specific triggering (× 1 ms)	

7.3.6.2 Mapping parameter of the Receive PDO

1,600 h – Mapping parameter for the PDO

Table 38: 1,600 h – mapping configured at the factory

Object Subindex	Access	Data type	Description
1,600 h	R/W	RECORD	Mapping parameter of the first Receive PDO

Object Subindex	Access	Data type	Description
00 h	R/W	UINT-8	Number of entries = 0 = PDO is deactivated

In the subindexes, the index, the subindex and the width of the affected Receive PDO sub-area are specified as follows:

Table 39: Mapping

Bits 31 ... 16	Bits 15 ... 8	Bits 7 ... 0
Index of the mapped object	Subindex of the mapped object	Length in bits

7.3.6.3 Communication parameter of the Transmit PDOs

The first two Transmit PDOs are activated at the factory using objects 1,800 h and 1,801 h. The remaining Transmit PDOs are deactivated using objects 1,802 h to 1,805 h.

1,800 h ... 1,805 h – Communication parameter for Transmit PDOs

Table 40: 1,800 h to 1,805 h

Object Subindex	Access	Data type	Description	
1,800 h ... 1,805 h	R/W	RECORD	Communication parameter of the Transmit PDOs	
00 h	R	UINT-8	Number of entries	
01 h	R/W	UINT-32	Bit	Description
			31	0: PDO is being used 1: PDO is not being used
			30	0: reacts to RTR 1: does not react to RTR
			29	0: 11 bit identifier (CAN 2.0A) 1: 29 bit identifier (CAN 2.0B)
			28 ... 0	COB-ID = 0,200 h + node ID
02 h	R/W	UINT-8	Transmission Type	Description
			0	Data is synchronized, but not cyclically sent
			1 ... 240	Cyclic transmission Clocked with the SYNC messages
			252	Query by the RTR telegram (synchronous transmission)
			253	Query by the RTR telegram (asynchronous transmission)
			254 +255	Event-controlled transmission when process data changes
03 h	R/W	UINT-16	Inhibition time = Idle time between two transmissions (× 0.1 ms)	
04 h	-	-	Reserved	
05 h	R/W	UINT-16	Event timer = Timer for application-specific triggering (× 1 ms)	

Inhibition time

The inhibition time (configured in objects 1,800.03 h to 1,805.03 h) in principle limits the communication of a device on the CANopen bus.

The inhibition time does not influence the triggering by RTR telegrams.

The inhibition time (transmit delay time) specifies the minimum waiting time in ms between the transmission of two identical Transmit PDOs. It always has higher priority than the event timer, the CoS events and triggering with SYNC messages. If, for example, the event timer is set to 100 ms and the inhibition time to 1 s, the respective PDO is only sent every second.

**NOTE**

Some bus module manufacturers do not support use of inhibition time. We recommend using synchronous communication if you want to control the bus load.

Event Timer

Subindex 05 h of the Transmit PDOs contains an event timer. It runs in the background and triggers an event when it expires. This means if no event occurs in the purely asynchronous transmission type (beam status change), a Transmit PDO will be sent when the set event time (in 1 ms increments) expires. No event timer can be set for the Receive PDO of the FlexChain.

7.3.6.4 Mapping parameter of the Transmit PDOs

Mappings are preconfigured at the factory for the 1A00 h and 1A01 h objects. No objects are mapped at the factory in the subindexes of the 1A02 h to 1A05 h objects.

1A00 h – Mapping parameter for the 1st Transmit PDO

Table 41: 1A00 h – mapping configured at the factory

Object Subindex	Access	Data type	Description
1A00 h	R/W	RECORD	Mapping parameter of the first Transmit PDO
00 h	R/W	UINT-8	Number of entries
2,064.0 h	R/W	UINT-32	System status
21E1.1 h	R/W	UINT-32	Qint 1...8
21E0.1 h	R/W	UINT-32	channel 1...8
21E0.2 h	R/R	UINT-32	channel 9...16
21E0.3 h	R/R	UINT-32	channel 17...24
21E0.4 h	R/R	UINT-32	channel 25...32
21E0.5 h	R/R	UINT-32	channel 33...40
21E0.6 h	R/R	UINT-32	channel 40...48

1A01 h – Mapping parameter for the 2nd Transmit PDO

Table 42: 1A01 h – mapping configured at the factory

Object Subindex	Access	Data type	Description
1A01 h	R/W	RECORD	Mapping parameter of the second Transmit PDO
00 h	R/W	UINT-8	Number of entries
01 h	R/W	UINT-32	2,200.0 Ch - IDI
02 h	R/W	UINT-32	21E0.7 h channel 49...56

Object Subindex	Access	Data type	Description
03 h	R/W	UINT-32	21E0.8 h channel 57...64

1A02 ... 1A05 h – Mapping Parameter for Transmit PDOs

Table 43: 1A02 to 1A09 h – Mapping configured at the factory

Object Subindex	Access	Data type	Description
1A02 h ... 1A05 h	R/W	RECORD	Mapping parameter of the remaining Transmit PDOs
00 h	R/W	UINT-8	Number of entries = 0 = PDOs are deactivated

How to change the content of the mapping objects:



NOTE

Parameter changes to the PDO mapping objects are only made in Pre-operational status.

1. First, set bit 31 to 1 in corresponding object 180xh in subindex 01 h.
2. Set subindex 00 h to 0 in object 1A0xh.
3. Configure the objects to be mapped in subindexes 01 h to n of object 1A0xh.
4. Set subindex 00 h of object 1A0xh to the number of mapped objects.
5. Then set bit 31 back to 0 in corresponding object 180xh in subindex 01 h.

In the subindexes, the index, the subindex and the width of the affected Receive PDO sub-area are specified as follows:

Table 44: Mapping

Bits 31 ... 16	Bits 15 ... 8	Bits 7 ... 0
Index of the mapped object	Subindex of the mapped object	Length in bits

7.4 RS485 configuration



NOTE

Compared to IO-Link and CANopen, for example, the RS-485 is a pure process data interface. Service data can be transmitted, but not changed.

RS-485 Framing

An RS-485 frame always consists of an <STX>, process data (ASCII hex or binary), <ETX>. Transmission in hexadecimal ASCII is the standard. The maximum process data length is 32 bytes. The process data length is 10 bytes ex-works. The following process data is transmitted by default.

Table 45: RS485 Framing

Byte	Function
Byte 1	System status
Byte 2	Qint 1 – 8
Byte 3	Channel 1 – 8
Byte 4	Channel 9 – 16
Byte 5	Channel 17 – 24
Byte 6	Channel 25 – 32

Byte	Function
Byte 7	Channel 33 – 40
Byte 8	Channel 41 – 48
Byte 9	Channel 49 – 56
Byte 10	Channel 57 – 64

The process data can be individually adapted via the USB interface and Sopas or via the IO-Link interface. (see configuration Sopas or configuration IO-Link)

Settings of the RS-485 interface

Trigger (index 473, subindex 1, 8 bit):

These settings cannot be made via RS-485, but they affect the RS-485 interface.

Table 46: Trigger (index 473, subindex 1, 8 bit)

Value	Name
0	Deactivated
1	On Process Data Change with Heartbeat
2	Time Interval
3	Command Byte Reception <STX><CMD><ETX>
4	Input Pin Level

On Change with Heartbeat:

- Interval Time in ms = 0; only in case of change
- Interval Time in ms > 0; in case of change, and time interval

Time Interval:

- Interval Time in ms = 0; continuous, the issue is synchronized with the internal process data cycle
- Interval Time in ms > 0; time Interval

Command Byte:

- <STX><CMD><ETX> / <0x02><0x54><0x03>
- 0x54 = 'T' = Trigger, Blocked Channel Hold Off, see "Commands", page 57

Input Pin:

- Issue as long as input = 1, the cycle time is identical to the current cycle time of the system, if the baud rate setting permits this.

Format (index 473, subindex 2, 8 bit):

Process data ASCII hexadecimal or binary.

Table 47: Process data ASCII hexadecimal or binary

Value	Name
0	Hexadecimal ASCII
1	Binary

Baud rate (index 473, subindex 3, 8 bit):

Discrete values 9k6, 38k4, 230k4, 460k8.

Table 48: Discrete values 9k6, 38k4, 230k4, 460k8

Value	Name
0	9,600 bits/s
1	38,400 bits/s
2	115,200 bits/s
3	230,400 bits/s

Value	Name
4	460,800 bits/s

Parity (index 473, subindex 4, 8 bit):

none oder even

Table 49: none oder even

Value	Name
0	No Parity
1	Even Parity

IntervalTime (index 473, subindex 5, 16 bit):

Table 50: Heartbeat off/Sync with Cycle Time

Value	Name
0	Heartbeat off/Sync with Cycle Time
1 - 60,000	

Commands

The commands can only be sent if the trigger is set in mode 3 = Command Byte Reception.

The following commands can be transmitted via the RS-485 to FlexChain. Each command starts with <STX> and ends with <ETX>.

- <STX><'C'><ETX>
Teach-in. Recommendation: Include system status in process date to be able to poll busy flag active bit.
- <STX><'H'><ETX>
Blocked Channels Hold on.
- <STX><'T'><ETX>
Trigger, Blocked Channel Hold Off.
- <STX><'o'><ETX>
Sender off.
- <STX><'s'><ETX>
Sender on

If a command is transferred to FlexChain which FlexChain does not know, FlexChain answers with

- <STX><'?'><ETX>
Negative response, unknown command.
- <STX><'N'><ETX>
Negative response, not available, (Teach-in).

RS-485 LED

- The LED flashes green for 20 ms with each frame transmitted, if the sequence is faster, the LED lights up constantly.
- In case of an unknown command, the LED flashes red once for 0.1 s.
- With 'Sender off' the LED flashes red once for 0.5 s.
- With 'Teach-In' the LED flashes red once for 1.0 s.

8 Diagnostics and troubleshooting

8.1 General diagnostic information

The Device Status object provides general diagnostic information about IO-Link and CANopen. A Device Status Information (e.g. Maintenance Required) can have several causes (e.g. Quality of Run Alarm or Teach-In Error) (see table). The Device Status can be retrieved via index 36 (IO-Link) or index 0x2024 (CANopen).

Table 51: General Diagnostic Information IO-Link & CANopen index

Object name	Description	IO-Link Index	CAN-Open Index
Device status	Provides information about the general status of the FlexChain system	36	0x2,024

Detailed information can be found in the IO-Link supplement and/or the ESD description.

Table 52: Value range of the Device Status

Value = highest is highest priority	Definition	Incident (System Status)
0	Device is operating properly	-
1	Maintenance Required	QualityOfRunAlarm OR TeachIn error
2	Out-of-Specification	PinShortCircuitWarning
3	Functional-Check	InvalidProcessData (caused by Busy = Configuration)
4	Failure	HardwareError OR Chain Issue - Error

In addition to the Device Status, the IO-Link interface offers events for error diagnosis. Detailed information can be found in the IO-Link supplement. The following information is available as events:

Table 53: Events

Event Name	Type
Device Hardware Fault	Error
Short Circuit on Output Pin	Warning
New Parameters	Notification
Quality of Run Alarm	Warning
Teach-In Error	Warning
Chain Issue Error	Error

8.2 Detailed diagnostic information

Detailed diagnostic information can be transmitted via the RS-485, CANopen and IO-Link serial interfaces and, to a limited extent, via the binary interface (switching outputs). In addition, SOPAS ET offers a user-friendly display of diagnostic information.

SOPAS

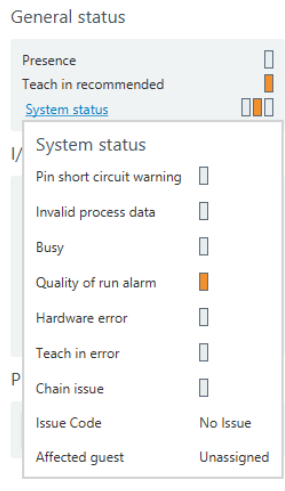

Figure 29: General status

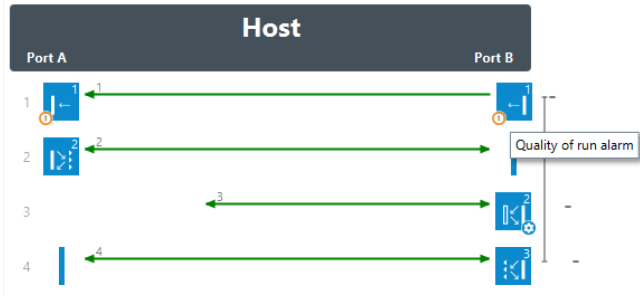

Figure 30: Troubleshooting host

Table 54: Diagnostic symbols

Icons	Description
	Note e.g. TeachIn recommended after running an AutoAssignment
	Error e.g. errors in the arrangement of the guests. A guest was disconnected during operation.
	Note e.g. TeachIn can only be carried out directly on the guest.
	Warning e.g. Quality of Run Alarm

In Sopas, the diagnosis status is displayed in the System Status field in traffic light colors. The following definition applies:

- Green: Device OK
- Yellow: Warning
- Red: Error

More detailed diagnostic information can be displayed by clicking the “System Status” field. In addition, the relevant guest is marked with an icon in the system field. More detailed information can be obtained via a mouse-over.

Via IO-Link, CAN and RS-485

Errors, warnings and messages are output by three main diagnostic objects. These are: System Status, Chain Issue and Quality of Run Alarm.

Only a limited diagnostic functionality is available for the RS-485 interface with the System Status. The System Status can be transferred via this interface, but cannot be parameterized.

The complete diagnostic information is available for the CANopen and IO-Link interfaces.

Table 55: Diagnostic Information IO-Link & CANopen Index

Object name	Description	IO-Link Index	CAN-Open Index
System status	Information about the status of the FlexChain system. Can be transmitted via the process data.	100	0x2,064
Chain Issue	Information on the structure and communication of the FlexChain system	300	0x212C
Quality of Run Alarm	Warning if the received signal falls below a stable value.	309	0x2,135
System Status Mask	Configuration for ORring the SystemStatus as binary signal via the PINs.	447, 448, 449, 450, 451, 452	0x21BF 0x21C0 0x21C1 0x21C2 0x21C3 0x21C4

A special feature to be emphasized is the System Status. This can be transmitted cyclically via all serial interfaces via the process data and as “Masked System Status” via the PINs. It gives an overview of the status of the system. The following information is available in the System Status.

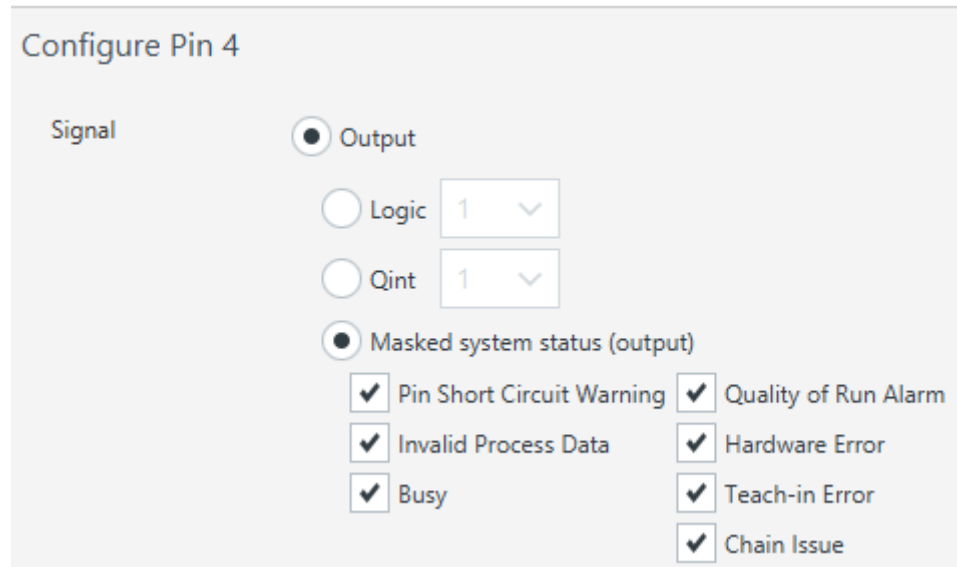





Figure 31: Configuration of PIN 4 / Masked System Status

Detailed information on the communication of the FlexChain system can be queried using the “Chain Issue” object. As with the Quality of Run Alarm, it is possible to localize the sensor via the object. The Chain Issue can be queried via the CANopen and IO-Link interfaces.

Diagnostic information via the display LEDs

Table 56: Diagnostics via display LEDs

				
Function	FlexChain Guest		Host only system traffic light	Host only PIN LEDs
	Sender	Receiver		
Supply	green permanently on	green permanently on	green permanently on	-
IO-Link Communication	-	-	green 1 Hz	-
No channel blocked Receiver sees signal	-	yellow on	Depending on the PIN configuration. Always displays the signal of the respective PIN.	-
Status of switching output/input	-	-	-	Status of the switching output or switching input
Quality of Run Alarm	-	yellow 8 Hz	yellow 8 Hz	-
Teach-in active	yellow 1 Hz min 3x flash	yellow 1 Hz min 3x flash	yellow 1 Hz min 3x flash	-
FindMe	green + yellow 1 Hz	green + yellow 1 Hz	green + yellow + red 1 Hz	Q-LEDs 1 Hz
Chain Issue - Error	-	-	red 8 Hz	PIN2 LED AA 8 Hz
Chain Issue - Warning	-	-	yellow 3 Hz	PIN2 LED AA 3 Hz
Hardware fault	yellow permanently on green off	yellow permanently on green off	red permanently on green off	-
Short circuit of a Q	-	-	red permanently on	-
TeachIn Error	-	yellow 8 Hz, poor alignment or an object in the beam path during the teach-in process.	yellow 8 Hz	PIN4 LED TCH 8 Hz
Local (control panel) activation of the pushbutton lock	-	-	yellow 8 Hz red 8 Hz	-
Activating/deactivating pushbutton lock	-	-	-	300 ms Inversion of the current status of all menu/PIN LEDs
Local (control panel) performing a factory reset	-	-	-	All menu LEDs flash 3x 1 Hz

8.3 Troubleshooting

FlexChain host

Table 57: FlexChain Host troubleshooting

LED indicator/fault pattern	Cause	Measures
red error LED lights up	Short-circuit	Check connections
Yellow TCH LED flashes (8 Hz) yellow presence LED flashes (8 Hz)	Teach-in faulty	Check the alignment of all guests Perform teach-in
Yellow LED AA flashes (8 Hz) Red LED Error flashes (8 Hz)	Position or zones inconsistent. Maximum number of guests exceeded. Communication error. Connection sequence changed.	Read out ChainIssue code (via IO-Link index 300, CANopen index 0x212C or Sopas) to restrict the error Check connection of all guests and alignment of the sensors Perform AutoAssign Perform teach-in

FlexChain Guests GL6-C

Table 58: FlexChain GL6-C troubleshooting

LED indicator/fault pattern	Cause	Measures
yellow LED of the GL6-C does not light up, no object in the beam path	Sensor not aligned correctly with the reflector or not taught in. Distance between sensor and reflector is too large	Check application Align the sensor with the reflector and teach in.
Yellow LED of the GL6-C lights up, although an object is in the beam path.	Object is too small or the beam is being reflected and diverted away from it.	Check application, if applicable remove reflection

FlexChain Guests GTB6-C

Table 59: FlexChain GTB6-C troubleshooting

LED indicator/fault pattern	Cause	Measures
yellow LED of the GTB6-C lights up, no object in the beam path	The sensing range distance is too large Background influence is too great.	Check application Reduce the sensing range
Yellow LED does not light up, an object is in the beam path	Object too small. Remission capability of the object is insufficient Distance between the sensor and the object is too long or sensing range is set too short	Check application Increase the sensing range

FlexChain Guests GSE6-C and SLG-2

Table 60: FlexChain GSE6-C and SLG-2 troubleshooting

LED indicator/fault pattern	Cause	Measures
Yellow LED of the GE6-C does not light up, no object in the path of the beam.	Distance between sender and receiver is too large: Sender not aligned correctly with receiver.	Check application Align the sender with the receiver and teach in.

LED indicator/fault pattern	Cause	Measures
Yellow LED of the GE6-C lights up, no object in the path of the beam.	Object is too small or the beam is being reflected and diverted away from it.	Check application Where applicable, remove the cause of the reflection

9 Maintenance

9.1 Maintenance

During operation, the device works maintenance-free.

Depending on the assignment location, the following preventive maintenance tasks may be required for the device at regular intervals:

Table 61: Maintenance schedule

Maintenance work	Interval	Implementation
Clean housing and front screen	Cleaning interval depends on ambient conditions and climate	Specialist
Check screw connections and plug connectors	Every 6 months	Specialist

10 Decommissioning

10.1 Disassembly and disposal

Disassembling the device

1. Switch off the supply voltage to the device.
2. Detach all connecting cables from the device.
3. If the device is being replaced, mark its position and alignment on the bracket or surroundings.
4. Detach the device from the bracket.

Disposing of the device

Any device which can no longer be used must be disposed of in an environmentally friendly manner in accordance with the applicable country-specific waste disposal regulations.



NOTE

Disposal of batteries, electric and electronic devices

- According to international directives, batteries, accumulators and electrical or electronic devices must not be disposed of in general waste.
- The owner is obliged by law to return this devices at the end of their life to the respective public collection points.



■ This symbol on the product, its package or in this document, indicates that a product is subject to these regulations.

10.2 Returning devices

- ▶ Do not dispatch devices to the SICK Service department without consultation.



NOTE

To enable efficient processing and allow us to determine the cause quickly, please include the following when making a return:

- Details of the contact person
- Description of the application
- Description of the fault that occurred

11 Technical data

11.1 Host performance

Table 62: Host performance

Attribute	Value
Number of connectable guests	max. 60 (max. 30 / port) ¹⁾
Number of channels	max. 255
Max. total cable length	40 m/port ²⁾
Max. sensor to sensor or sensor to host cable length	30 m

1) Number depends on the type of connected sensors

2) For > 25 guests/port: Total length plus additional extension cables ≤ 10 m/port

11.2 Interfaces host

Table 63: Interfaces host

Attribute	Standard IO-Link	Advanced IO-Link	CANopen		RS485	
			System/Q	CAN connector		
No. of IOs (push-pull switching mode)	1xQ 2xI/O	1xQ 5xI/O	1xQ 1xI/O	-	1xQ 1xI/O	
Serial process data interface	IO-Link	IO-Link	IO-Link	CANopen	IO-Link RS485	
Parameterization interface	Control panel IO-Link USB	Control panel IO-Link USB	Control panel IO-Link USB CANopen		Control panel IO-Link USB	
Data transmission rate	COM3 (230.4 kbit/s)		COM3 (230.4 kbit/s)	50 kbit/s, 125 kbit/s, 250 kbit/s, 500 kbit/s, 1 Mbit/s	COM3 (230.4 kbit/s) , 9.6 kbit/s, 38.4 kbit/s, 11.52 kbit/s , 230.4 kbit/s , 460.8 kbit/s	
Connection type (control) Pigtail length 0.5 m (except CANopen)	PIN	M12, 5-pin, male	M12, 8-pin, male	M12, 5-pin, male	M12, 5 pole, male Pigtail length 0.3 m	M12, 8-pin, male
	1	L+ (BN)	L+ (BN)	L+ (BN)	n.c. (BN)	L+ (BN)
	2	Q2 / IN1 (WH)	Q2 / IN1 (WH)	Q2 / IN1 (WH)	n.c. (WH)	Q2 / IN1 (WH)
	3	M (BU)	M (BU)	M (BU)	GND (BU)	M (BU)
	4	Q1 / C (BK)	Q1 / C (BK)	Q1 / C (BK)	CAN1_H (VT)	Q1 / C (BK)
	5	Q3 / IN2 (GY)	Q3 / IN2 (GY)	n.c. (GY)	CAN1_L (OG)	n.c. (GY)
	6	-	Q4 / IN3 (PK)	-	-	n.c. (PK)
	7	-	Q5 / IN4 (VT)	-	-	RS485_A (VT)
	8	-	Q6 / IN5 (OG)	-	-	RS485_B (OG)
Connection type (USB)	Pigtail length 0.3 m micro USB					

Attribute	Standard IO-Link	Advanced IO-Link	CANopen		RS485
			System/Q	CAN connector	
Connection type (guests)	Port A and port B Pigtail length each 1.5 m Pigtail M8, 4 pole, female				

¹ For > 25 guests/port: Total length plus additional extension cables ≤ 10 m/port

11.3 Host software features

Table 64: Host software features

Attribute	Value
Host software features	Guest parameterization Zone definition Measurement functions, logic gates Interface parameterization Service data

11.4 System response time

Table 65: System response time

Attribute	Value
Scan time (reproducibility) $T_{scan}^{6)}$	$T_{FC_Scan} = \sum_{i=1}^N T_{FC_Guest\ i}$ <p>Minimum scan time = 1 ms $T_{FC_GTB6} = 185 \mu s$ $T_{FC_GL6} = 185 \mu s$ $T_{FC_GSE6} = 210 \mu s$ $T_{FC_SLG2_A}^{2)} = 248 \mu s + N^1) \times 46 \mu s$ $T_{FC_SLG2_B}^{3)} = 280 \mu s + N^1) \times 78 \mu s$</p>
Maximum minimum dwell time	$2x T_{scan}^{4)}$
Maximum response time	$3x T_{scan} + 500 \mu s^{5)}$

- 1) N = number of beams/channels
- 2) Sensing range type A: SLG-2 with 4 m operating range
- 3) Sensing range type B: SLG-2 with 7 m operating range
- 4) With light grid sensing range type B; minimum dwell time = $4 \times T_{scan}$
- 5) With light grid sensing range type B; response time = $5 \times T_{scan} + 500 \mu s$
- 6) SLG2: If cross beam is activated, the scanning time of the individual light grid doubles.

11.5 Mechanics/electronics/host

Table 66: Mechanics/electronics/host

Attribute	Value
Supply voltage V_s	24 V ±20% ¹⁾
Maximum current consumption (at maximum number of guests)	600 mA @ 24 V ²⁾
Output current	Max. 100 mA

Attribute	Value
Logic level	Active 15 V ... 30 V Inactive 0 V ... 5 V
Capacitive output load	max. 100 nF
Inductive output load	max. 1 H
Dimensions in mm	118 x 35 x 25 (without cables)
Housing material	Plastic, ABS
Enclosure rating	IP65 / IP67
Electrical protection class	III
Circuit protection	UV connections, reverse polarity protected Output Q short-circuit protected Interference-pulse suppression
Storage temperature	-25° C to 70° C
Operating temperature	Host -25° C - 50° C
Vibration/shock resistance of host	Single Shock: 30 g, 11 ms, 6 each axis DIN EN 60068-2-27 Continuous Shock: 25 g, 6 ms, 1000 each axis DIN EN 60068-2-27 Vibration: 10 grms 20 Hz...2,000 Hz, 2 h each axis IEC 60068-2-64
Electromagnetic compatibility	61000-6-2 immunity / 61000-6-3 emission
MTBF	> 50,000 h
Weight of host	5-pin IO-Link: 154 g 8-pin IO-Link, RS485: 161 g CANopen: 170 g
Initialization time	< 3 s
Synchronization of port A/port B	Cable

1) Operation in short-circuit protected network max. 8 A

2) Without load on the outputs

11.6 Technical data guests

11.6.1 Technical data G6-C – general

Table 67: General data GL6-C

Attribute	Value
Enclosure rating	IP67
Protection class	III
Circuit protection	A, D ¹⁾
Ambient operating temperature	-25 °C – 55 °C
Vibration/shock resistance of G6 guest	Single Shock: 30 g, 11 ms, 6 each axis DIN EN 60068-2-27 Continuous Shock: 25 g, 6 ms, 1,000 each axis DIN EN 60068-2-27 Vibration: 10 grms 20 Hz...2,000 Hz, 2 h each axis IEC 60068-2-64

Attribute	Value
Weight of G6 guests	23 g (GTB, GL, GS, GE)

- 1) A = U_B connections reverse polarity protected
 C = interference suppression
 D = outputs overcurrent and short-circuit protected

11.6.2 Technical data GL6-C

Table 68: General data GL6-C

Attribute	Value
Sensing range RW max. (with PL80A reflector)	0.03 ... 6.0 m
Light spot diameter/distance	8 mm / 350 mm

11.6.3 Technical data GSE6-C

Table 69: General data GSE6-C

Attribute	Value
Sensing range RW max. (with PL80A reflector)	0 ... 15 m
Light spot diameter/distance	375 mm / 12 m

11.6.4 Technical data GTB6-C

Table 70: General data GTB6-C

Attribute	Value
Sensing range RW max (with 90% remission)	5 ... 250 mm
Light spot diameter/distance	6 mm / 100 mm

11.6.5 Technical data SLG-2

Table 71: SLG-2 features

Features	
Technology	Sender/receiver
Beam separation	10/25/50 mm
MDO ¹⁾ parallel beam	15/30/55 mm
MDO ¹⁾ cross beam (detection only)	9/16.5/29 mm – in the range (0.25 to 0.75) x sender-receiver distance
Parameterization	via FlexChain Host

- 1) MDO = Minimum Detectable Object.

Table 72: Performance SLG-2

Performance	
Operating range	Type A: 4 m Type B: 7 m
Maximum sensing range	Type A: 6 m Type B: 10 m
Minimum distance	0 m
Minimum distance Cross-beam function active	5 x beam separation

Table 73: Mechanics/electronics

Mechanics/electronics	
Wavelength	850 nm

Mechanics/electronics	
Protection class	III
Dimensions	12x24 mm ²)
Housing material	PMMA, aluminum
Enclosure rating	IP65 / IP67
Longitudinal cascading without blind zones	Depending on the required MDO and the device lengths, there are different specifications for the installation of the light grid as well as the permissible temperature range in the application. (see under Cascading several light grids)

2) Customer-specific cable lengths can be implemented.

Table 74: Ambient data

Ambient data	
Protection class	Protection class III according to EN61140
EMC	61000-6-2, 61000-6-4
Ambient light immunity	30,000 lx direct sunlight 100,000 lx direct sunlight: special device on request
Ambient temperature	-25 °C to +55 °C
Storage temperature	-25 °C – 70 °C
Vibration resistance	0.5 mm, 10 Hz ... 55 Hz
Impact load	10 g 16 ms -> DIN EN 60068-2-27
Certificates	UL, RoHS, CE, CCC, ACMA, EAC, WEEE

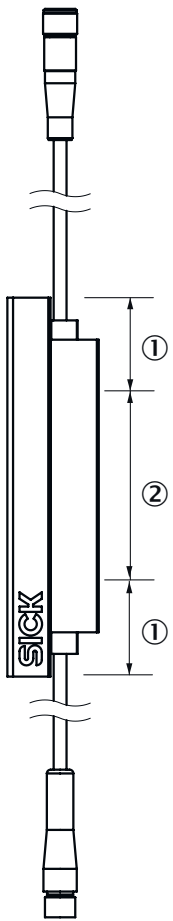

- ① Distance housing edge to mounting bracket ≤ 10 cm
- ② Distance mounting bracket to mounting bracket ≤ 75 cm
(in an application with high mechanical loads (vibration, shock) ≤ 40 cm)

Figure 32: Mounting bracket and mounting distance

Mounting distance d_m between cascading light grids taking into consideration temperature fluctuations.

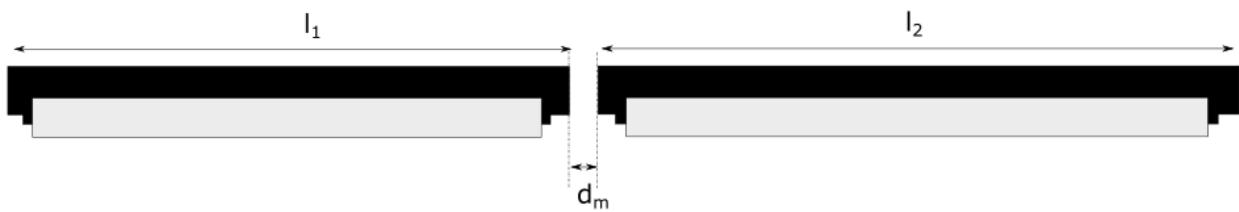

Figure 33: Cascading several light grids

Table 75: Mounting distance d_m between cascading light grids taking into consideration temperature fluctuations.

	$l_1 + l_2$				$d_m^{2)}$	$MDO_k^{4)}$
	1,600 mm	2,000 mm	2,400 mm	2,800 mm		
ΔT	± 9 K	± 7 K	± 6 K	± 5 K	0.55 mm	$d_c^{3)} + 5$ mm
	± 16 K	± 13 K	± 11 K	± 9 K	1.05 mm	$d_c^{3)} + 6$ mm
	± 24 K	± 19 K	± 16 K	± 14 K	1.55 mm	$d_c^{3)} + 7$ mm
	± 48 K	± 38 K	± 32 K	± 27 K	3.05 mm	$d_c^{3)} + 10$ mm

1) MDO_k = Smallest detectable object between two cascades.

2) Mounting distance d_m between cascading SLGs

3) Beam separation d_c

11.7 Dimensional drawings

FlexChain Host

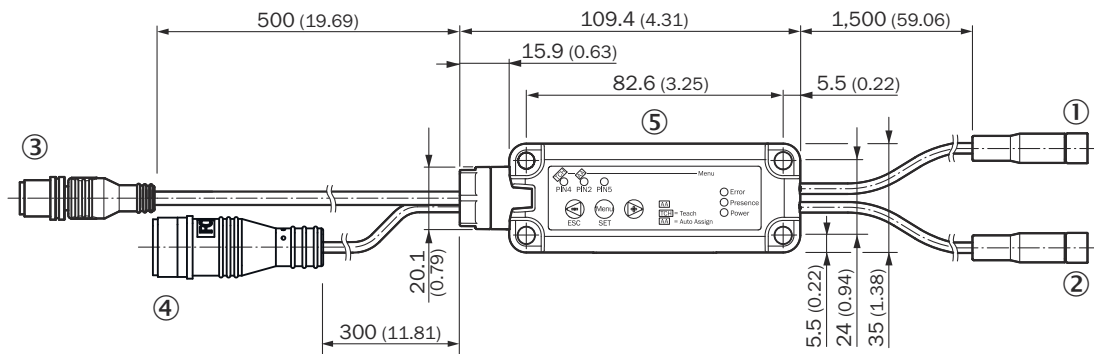

Figure 34: Dimensional drawing – FlexChain Host Standard

- ① Port-A, pigtail M8, 4-pin, female
- ② Port B, pigtail M8, 4-pin, female
- ③ PLC, pigtail M12, 5-pin / 8-pin, male
- ④ Micro USB
- ⑤ Control panel

FlexChain Host CANopen

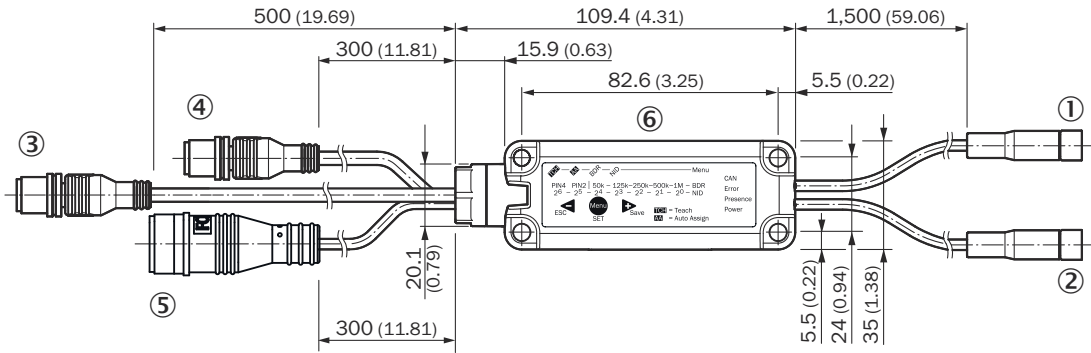

Figure 35: Dimensional drawing - FlexChain Host CANopen

- ① Port-A, pigtail M8, 4-pin, female
- ② Port B, pigtail M8, 4-pin, female
- ③ PLC PLC, pigtail M12, 5-pin, male
- ④ CANopen PLC, pigtail M12, 5-pin, male
- ⑤ Micro USB
- ⑥ Control panel

FlexChain GL6-C

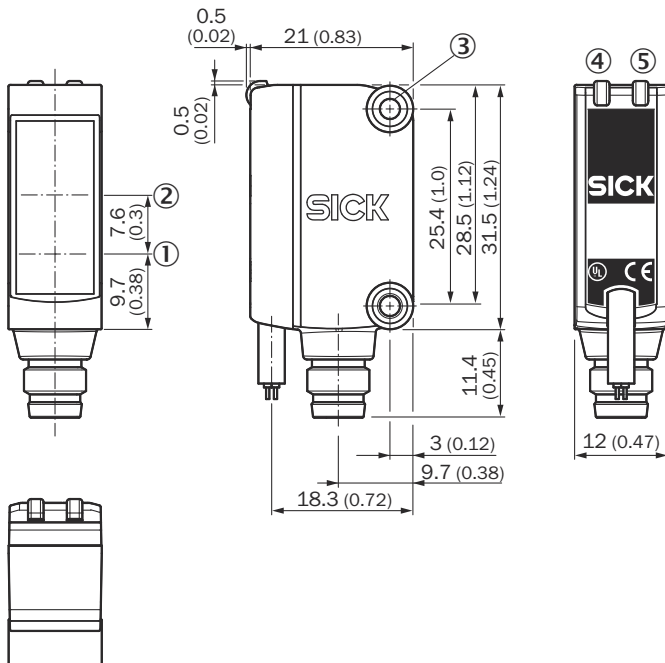

Figure 36: Dimensional drawing - FlexChain GL6-C

- ① Center of optical axis, sender
- ② Center of optical axis, receiver
- ③ M3 threaded mounting hole
- ④ LED indicator green
- ⑤ LED indicator yellow

FlexChain GSE6-C

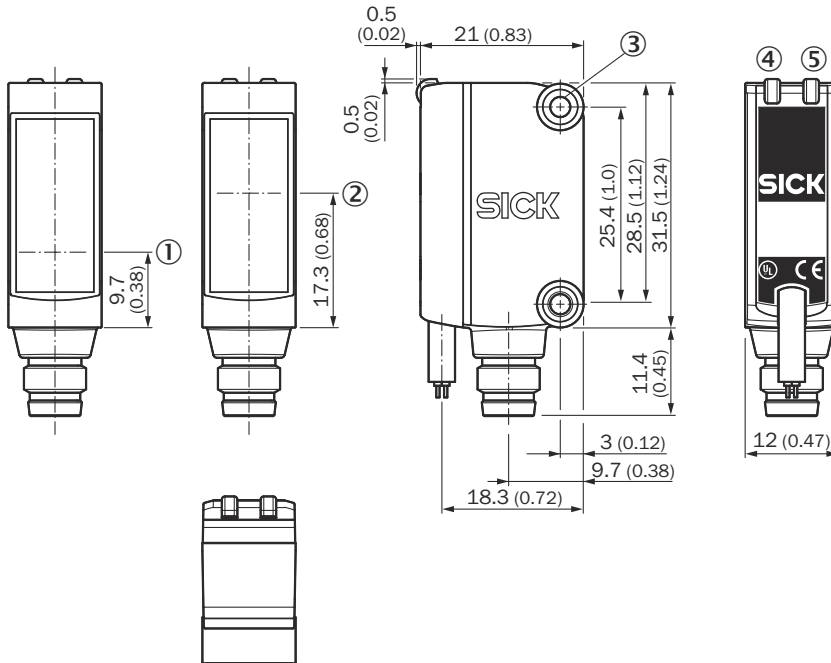

Figure 37: Dimensional drawing - FlexChain GSE6-C

- ① Center of optical axis, sender
- ② Center of optical axis, sender
- ③ M3 threaded mounting hole
- ④ LED indicator green
- ⑤ LED indicator yellow

FlexChain GTB6-C

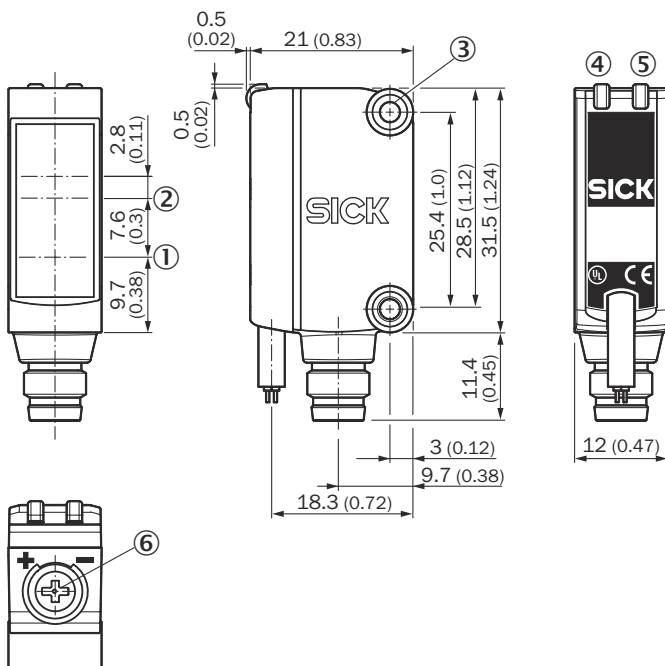

Figure 38: Dimensional drawing - FlexChain GSE6-C

- ① Center of optical axis, sender
- ② Center of optical axis, receiver

- ③ M3 threaded mounting hole
- ④ LED indicator green
- ⑤ LED indicator yellow
- ⑥ Potentiometer: adjusting the sensing range

SLG-2

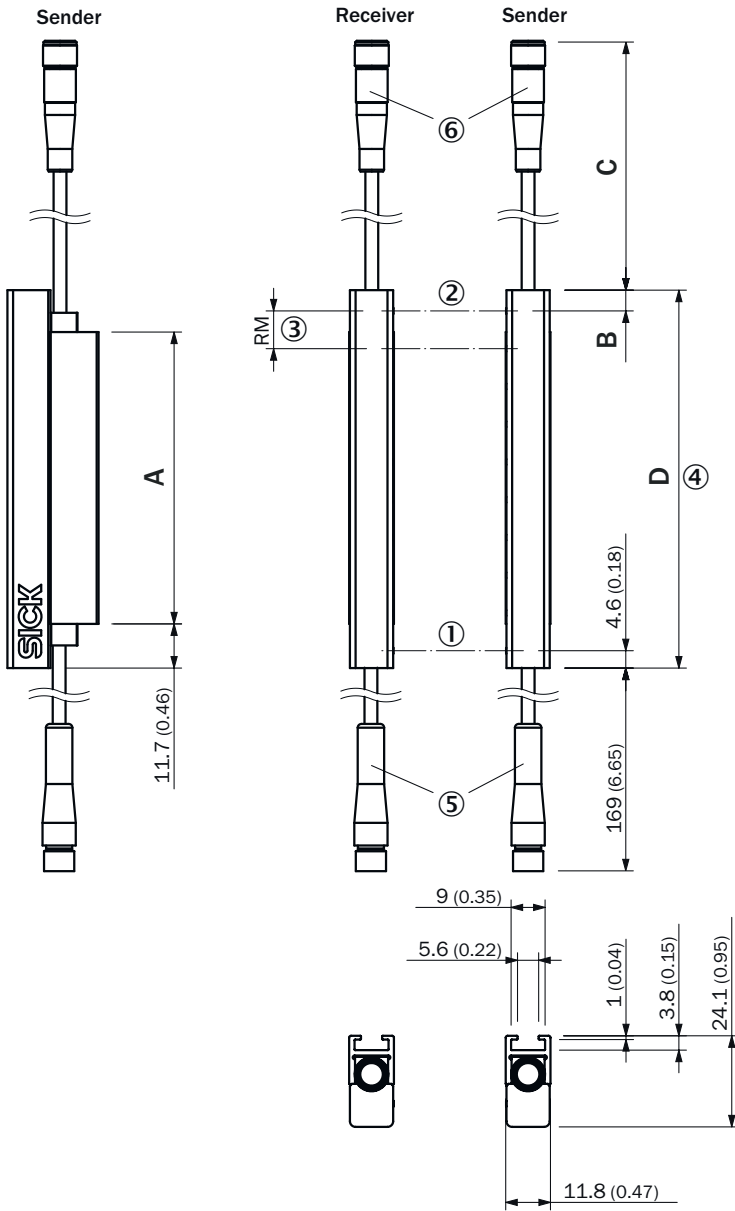

Figure 39: SLG-2 Flat

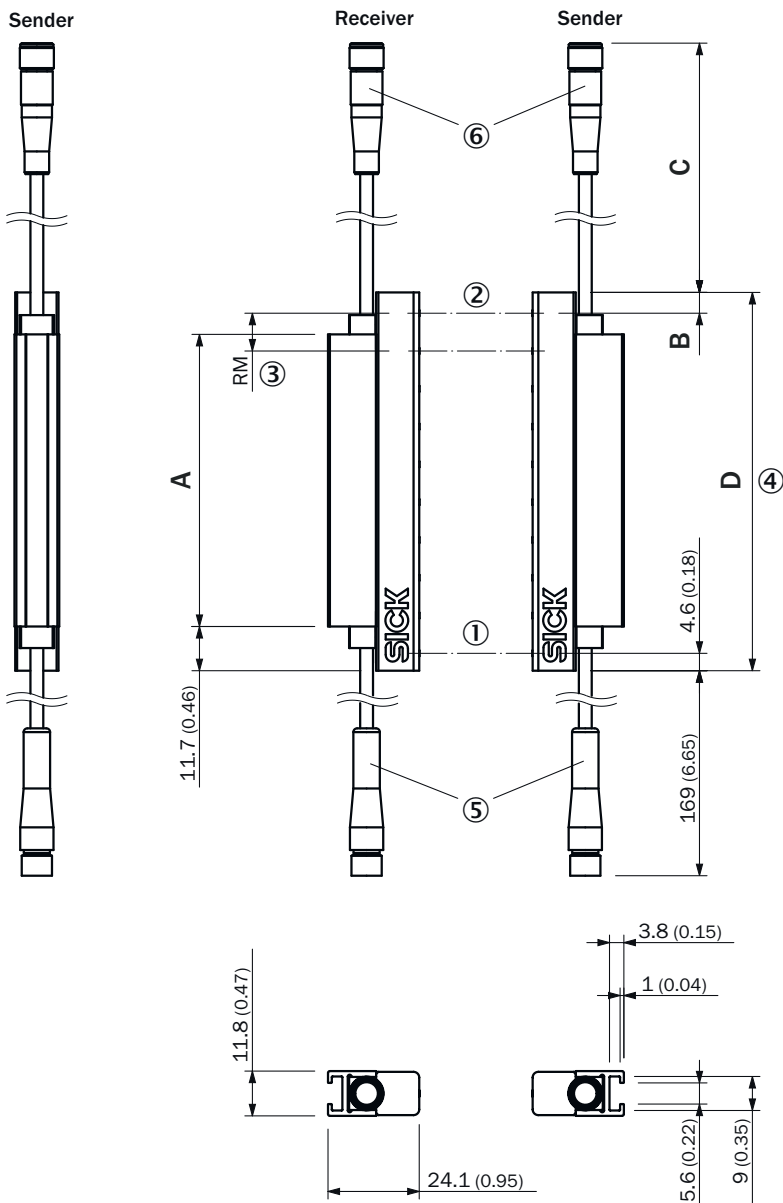

Figure 40: SLG-2 Slim

Table 76: Length aluminum profile/housing length

	A	D
SLGxxx-010xxxxxxx	77 mm	99,2
SLGxxx-020xxxxxxx	178 mm	199,2
SLGxxx-030xxxxxxx	276 mm	299,2
SLGxxx-040xxxxxxx	376 mm	399,2
SLGxxx-050xxxxxxx	475 mm	499,2
SLGxxx-060xxxxxxx	576 mm	599,2
SLGxxx-070xxxxxxx	676 mm	699,2
SLGxxx-080xxxxxxx	776 mm	799,2
SLGxxx-100xxxxxxx	975 mm	999,2
SLGxxx-120xxxxxxx	1,175 mm	1,199,2
SLGxxx-140xxxxxxx	1,374 mm	1,399,2

Table 77: Distance from upper edge to last beam

	B
SLG10x-xxxxxxxxxxx	4.6 mm ¹⁾
SLG25x-xxxxxxxxxxx	19.6 mm ¹⁾
SLG50x-xxxxxxxxxxx	44.6 mm ¹⁾

1) For a detection height < 700 mm, the measured value can vary by up to 1 mm from the measurements specified here.

Table 78: Length of cable

	C
SLGxxx-xxxxxAxxxx	514 mm
SLGxxx-xxxxxBxxxx	1,514 mm

1) For a detection height < 700 mm, the measured value can vary by up to 1 mm from the measurements specified here.

11.8 FlexChain Host control panel



Figure 41: FlexChain Host IO-Link Standard control panel

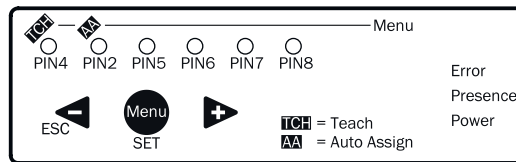

Figure 42: FlexChain Host IO-Link Advanced control panel

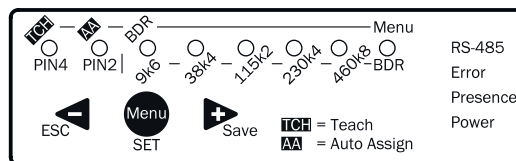

Figure 43: FlexChain Host RS485 control panel

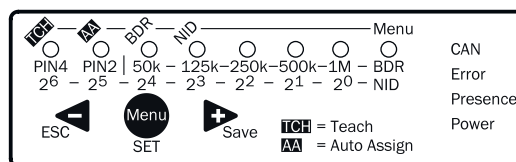

Figure 44: FlexChain Host CANopen control panel

12 Accessories



NOTE

Accessories can be found on the online product page at:

- ▶ www.sick.com/FlexChain
-

13 Annex

13.1 EU declaration of conformity and certificates

The EU declaration of conformity and other certificates can be downloaded from the Internet at:

▶ www.sick.com/FlexChain

13.2 Licenses

SICK uses open source software which is published by the rights holders under a free license. Among others, the following license types are used: GNU General Public License (GPL version 2, GPL version 3), GNU Lesser General Public License (LGPL), MIT license, zlib license and licenses derived from the BSD license.

This program is provided for general use without warranty of any kind. This warranty disclaimer also extends to the implicit assurance of marketability or suitability of the program for a particular purpose.

More details can be found in the GNU General Public License. View the complete license texts here: www.sick.com/licensetexts. Printed copies of the license texts are also available on request.

Australia

Phone +61 (3) 9457 0600
1800 33 48 02 – tollfree
E-Mail sales@sick.com.au

Austria

Phone +43 (0) 2236 62288-0
E-Mail office@sick.at

Belgium/Luxembourg

Phone +32 (0) 2 466 55 66
E-Mail info@sick.be

Brazil

Phone +55 11 3215-4900
E-Mail comercial@sick.com.br

Canada

Phone +1 905.771.1444
E-Mail cs.canada@sick.com

Czech Republic

Phone +420 234 719 500
E-Mail sick@sick.cz

Chile

Phone +56 (2) 2274 7430
E-Mail chile@sick.com

China

Phone +86 20 2882 3600
E-Mail info.china@sick.net.cn

Denmark

Phone +45 45 82 64 00
E-Mail sick@sick.dk

Finland

Phone +358-9-25 15 800
E-Mail sick@sick.fi

France

Phone +33 1 64 62 35 00
E-Mail info@sick.fr

Germany

Phone +49 (0) 2 11 53 010
E-Mail info@sick.de

Greece

Phone +30 210 6825100
E-Mail office@sick.com.gr

Hong Kong

Phone +852 2153 6300
E-Mail ghk@sick.com.hk

Hungary

Phone +36 1 371 2680
E-Mail ertesites@sick.hu

India

Phone +91-22-6119 8900
E-Mail info@sick-india.com

Israel

Phone +972 97110 11
E-Mail info@sick-sensors.com

Italy

Phone +39 02 27 43 41
E-Mail info@sick.it

Japan

Phone +81 3 5309 2112
E-Mail support@sick.jp

Malaysia

Phone +603-8080 7425
E-Mail enquiry.my@sick.com

Mexico

Phone +52 (472) 748 9451
E-Mail mexico@sick.com

Netherlands

Phone +31 (0) 30 229 25 44
E-Mail info@sick.nl

New Zealand

Phone +64 9 415 0459
0800 222 278 – tollfree
E-Mail sales@sick.co.nz

Norway

Phone +47 67 81 50 00
E-Mail sick@sick.no

Poland

Phone +48 22 539 41 00
E-Mail info@sick.pl

Romania

Phone +40 356-17 11 20
E-Mail office@sick.ro

Russia

Phone +7 495 283 09 90
E-Mail info@sick.ru

Singapore

Phone +65 6744 3732
E-Mail sales.gsg@sick.com

Slovakia

Phone +421 482 901 201
E-Mail mail@sick-sk.sk

Slovenia

Phone +386 591 78849
E-Mail office@sick.si

South Africa

Phone +27 10 060 0550
E-Mail info@sickautomation.co.za

South Korea

Phone +82 2 786 6321/4
E-Mail infokorea@sick.com

Spain

Phone +34 93 480 31 00
E-Mail info@sick.es

Sweden

Phone +46 10 110 10 00
E-Mail info@sick.se

Switzerland

Phone +41 41 619 29 39
E-Mail contact@sick.ch

Taiwan

Phone +886-2-2375-6288
E-Mail sales@sick.com.tw

Thailand

Phone +66 2 645 0009
E-Mail marcom.th@sick.com

Turkey

Phone +90 (216) 528 50 00
E-Mail info@sick.com.tr

United Arab Emirates

Phone +971 (0) 4 88 65 878
E-Mail contact@sick.ae

United Kingdom

Phone +44 (0)17278 31121
E-Mail info@sick.co.uk

USA

Phone +1 800.325.7425
E-Mail info@sick.com

Vietnam

Phone +65 6744 3732
E-Mail sales.gsg@sick.com

Detailed addresses and further locations at www.sick.com