



### Fieldbus gateway

- Gateway for industrial Ethernet and fieldbus standards
- Up to 128 input and 128 output variables can be transmitted
- Easy integration in the process control level through system-specific device description files
- “Batch controller” for precise dosing of liquids
- High system availability with PROFINET system redundancy S2

Product variants described in the data sheet may differ from the product presentation and description.

### Can be combined with

	<b>Type 8742</b> Mass flow controller (MFC)/ mass flow meter (MFM) for gases	▶
	<b>Type 8746</b> Mass flow controller (MFC)/mass flow meter (MFM) for gases	▶
	<b>Type 8905</b> Online water analysis system	▶
	<b>Type 8652</b> AirLINE – the valve island optimised for process automation	▶
	<b>Type 8691</b> Control head for decentralised automation of ELEMENT process valves	▶
	<b>Type 8692</b> Digital electro-pneumatic positioner for integrated mounting on process control valves	▶
	<b>Type 8693</b> Digital electropneumatic process controller for integrated mounting on process control valves	▶
	<b>Type 8098</b> FLOWave SAW flowmeter	▶

### Type description

The fieldbus gateway Type ME43 is the central control unit for Bürkert products (valves, sensors, mass flow controllers or displays), which are based on EDIP (“Efficient Device Integration Platform”). The basic variant of Type ME43 consists of a fieldbus coupler which transmits the internal CANopen-based communication of the Bürkert field devices to industry standards for industrial Ethernet and fieldbus. With the help of graphical programming, which the module supports, sub-systems can be automated specifically to the customer’s needs (e.g. controlled mixing of gases, error monitoring through limit value switches, time switches).

DTS 1000328369 EN Version: S Status: RL (released | freigegeben | valide) printed: 18.12.2024

## Table of contents

<b>1. General technical data</b>	<b>3</b>
<hr/>	
<b>2. Approvals and conformities</b>	<b>4</b>
2.1. General notes .....	4
2.2. Conformity .....	4
2.3. Standards .....	4
2.4. Explosion protection.....	4
2.5. North America (USA/Canada) .....	4
<hr/>	
<b>3. Dimensions</b>	<b>5</b>
3.1. Variant with spring terminal block for bÜS connection (example) .....	5
<hr/>	
<b>4. Device/Process connections</b>	<b>6</b>
4.1. Pin assignment .....	6
<hr/>	
<b>5. Product design and assembly</b>	<b>7</b>
5.1. Product features .....	7
<hr/>	
<b>6. Product accessories</b>	<b>8</b>
6.1. EDIP – Efficient Device Integration Platform .....	8
6.2. Bürkert Communicator Software .....	8
<hr/>	
<b>7. Networking and combination with other Bürkert products</b>	<b>9</b>
<hr/>	
<b>8. Ordering information</b>	<b>9</b>
8.1. Bürkert eShop .....	9
8.2. Bürkert product filter .....	9
8.3. Ordering chart .....	10
8.4. Ordering chart Accessories .....	10

DTS 1000328369 EN Version: S Status: RL (released | freigegeben | validé) printed: 18.12.2024

## 1. General technical data

### Product properties

Dimensions	Further information can be found in chapter <b>"3. Dimensions"</b> on page 5.
Weight	0.322 kg

### Material

Body	PC (polycarbonate)
Status display	RGB LED according to NAMUR NE107
Configuration storage	Micro-SD card (not included in delivery) (for storing device parameters, configuration and easy replacement of a module)

### Electrical data

Operating voltage	24 V DC $\pm$ 10 %, residual ripple 10 % <sup>1)</sup>
Power consumption of the module	2 W
Current limitation	3.2 A at 24 V
Maximum output current	400 mA (at 3.3 V and 5 V)

### Process/Port connection & communication

Communication link (integrated switch for Industrial Ethernet)	PROFINET PROFINET S2 EtherNet/IP Modbus TCP PROFIBUS DPV1 EtherCAT CC-Link
---	--

### Approvals and conformities

Further information can be found in chapter **"2. Approvals and conformities"** on page 4.

### Environment and installation

Ambient temperature	- 20 °C...+ 60 °C
Storage temperature	- 30 °C...+ 80 °C
Degree of protection	IP20 (Fieldbus gateway)
Height above sea level	Maximum 2000 m

1.) The requirements of all connected components must be taken into consideration when selecting the power supply.

## 2. Approvals and conformities

### 2.1. General notes

- The approvals and conformities listed below must be stated when making enquiries. This is the only way to ensure that the product complies with all required specifications.
- Not all available versions can be supplied with the below mentioned approvals or conformities.

### 2.2. Conformity

In accordance with the Declaration of Conformity, the product is compliant with the EU Directives.

### 2.3. Standards

The applied standards which are used to demonstrate compliance with the EU Directives are listed in the EU-Type Examination Certificate and/or the EU Declaration of Conformity.

### 2.4. Explosion protection

Approval	Description
	<p><b>Optional: Explosion protection</b></p> <p><b>ATEX:</b> BVS 18 ATEX E 051 X II 3G Ex ec IIC T4 Gc</p> <p><b>IECEx:</b> IECEx BVS 18.0041X Ex ec IIC T4 Gc</p>

### 2.5. North America (USA/Canada)

Approval	Description
	<p><b>Optional: UL Listed for the USA and Canada</b></p> <p>The products are UL Listed for the USA and Canada according to:</p> <ul style="list-style-type: none"> <li>• UL 61010-1 (ELECTRICAL EQUIPMENT FOR MEASUREMENT, CONTROL, AND LABORATORY USE – Part 1: General Requirements)</li> <li>• CAN/CSA-C22.2 No. 61010 - 1 - 12</li> </ul>

### 3. Dimensions

#### 3.1. Variant with spring terminal block for büS connection (example)

**Note:**

Dimensions in mm

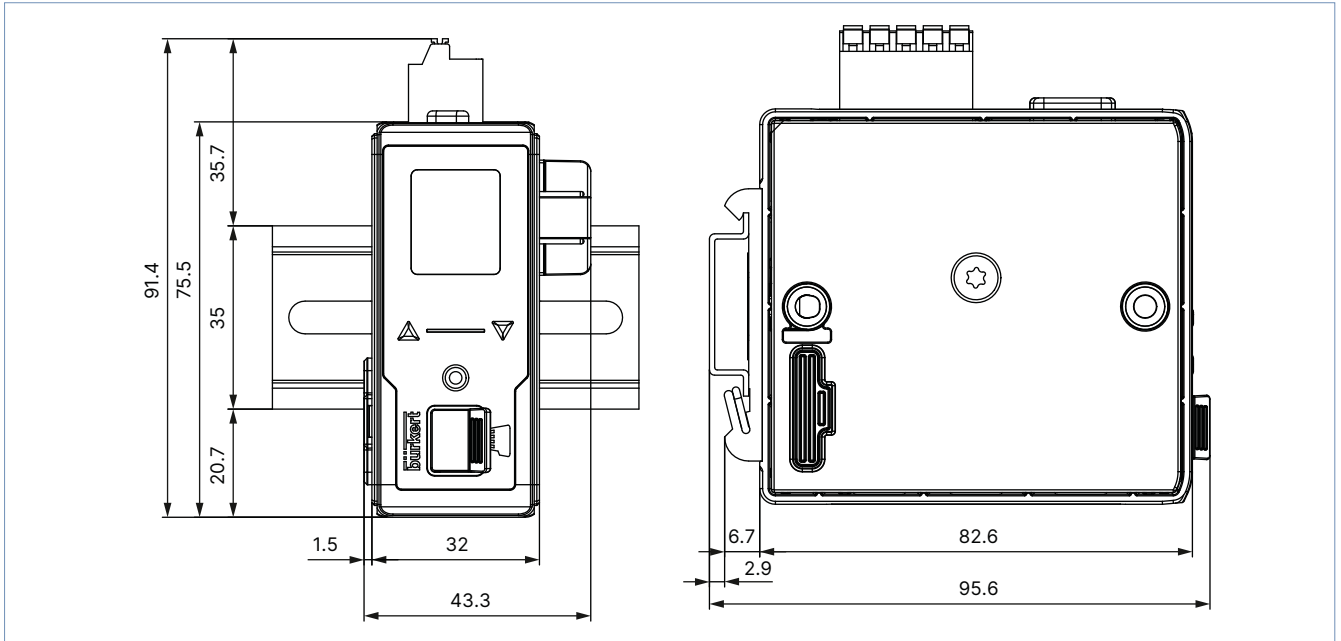

## 4. Device/Process connections

### 4.1. Pin assignment

**Note:**

- The termination resistor can be plugged in easily to the right of the module (included in delivery. It can also be ordered as an accessory. For the Article no. see ["8.4. Ordering chart Accessories" on page 10](#)).
- CANopen requires 2 terminating resistors: one at the beginning of the network and one at the end. An indicator of the correct bus scheduling is the resistance between CAN\_H and CAN\_L when the power is switched off. This should be approx. 60 Ω.

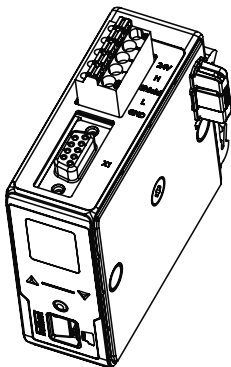
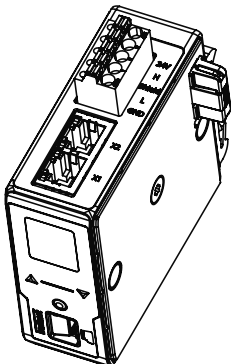
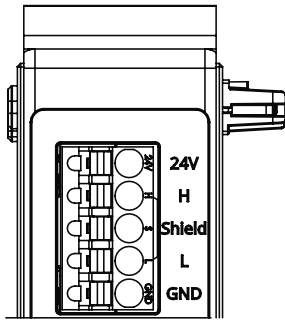

CANopen / bÜS – Spring terminal, 5-pin	Colour	Pin assignment
	Red	24 V DC
	White	CAN H (bÜS connection)
	Green	SHIELDING
	Blue	CAN L (bÜS connection)
	Black	GND
Industrial Ethernet (PROFINET I/O, EtherNet/IP, Modbus TCP, EtherCAT, CC-Link IE Field Basic) or PROFINET S2 – Interface X1 and X2 RJ45	Pin	Pin assignment
	1	TX +
	2	TX –
	3	RX +
	4	Not assigned
	5	Not assigned
	6	RX –
	7	Not assigned
	8	Not assigned
PROFIBUS DPV1 – D-Sub 9-pin, female	Pin	Pin assignment
	1	SHIELDING
	2	M24 (optional)
	3	RxD/TxD-P (B-Line)
	4	CNTR-P (optional)
	5	DGND
	6	+ 5 V (supply for the termination resistor)
	7	+ 24 V (optional)
	8	RxD/TxD-N (A-Line)
	9	CNTR-N (optional)
CC-Link D-Sub 9-pin, female	Pin	Pin assignment
	1	Not assigned
	2	Not assigned
	3	DA data cable – (A-Line)
	4	DG data ground
	5	Not assigned
	6	Not assigned
	7	Not assigned
	8	DB data cable + (B-Line)
	9	Not assigned

## 5. Product design and assembly

### 5.1. Product features

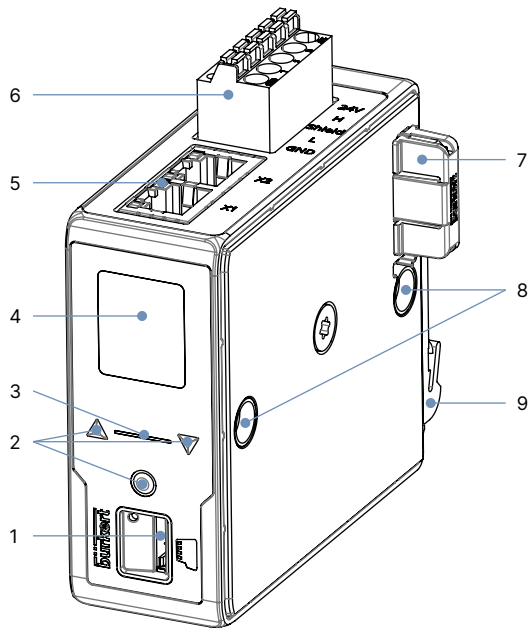

No.	Description
1	Micro-SD card slot
2	Buttons
3	NAMUR-LED
4	Display
5	Fieldbus connection
6	büS connector
7	Termination resistor <sup>1)</sup>
8	Fastening to the valve island (Type 8652)
9	Standard rail

1.) Included in delivery

## 6. Product accessories

### 6.1. EDIP – Efficient Device Integration Platform

EDIP is a Bürkert device platform that standardises the operation, communication and interfaces of many process devices (e.g. sensors, mass flow controllers). Thanks to EDIP, devices can be intelligently networked and operated with the standardized software, the Bürkert Communicator. The backbone and connecting link of EDIP is a digital interface that complies with the CANopen standard and can always be used in a manner compatible with it.

EDIP offers the user the following advantages:

- Interoperability - guaranteed by the uniform interface
- Comfortable operation and display concept
- Faster and simplified commissioning
- Modularity - allows the devices to be adapted to individual customer requirements
- Easy transfer and fusion of device settings

### 6.2. Bürkert Communicator Software

#### Note:

The associated communication software can be downloaded under **Type 8920** ▶.

The Bürkert Communicator is the most important software tool of the device platform EDIP (Efficient Device Integration Platform). The extensive features of this universal tool facilitate the configuration and parameterisation of all devices equipped with the digital CANopen-based interface. The Bürkert Communicator provides the user with a complete overview of all cyclic process values and acyclic diagnostic data. The integrated graphical programming environment enables the creation of control functions for decentralised sub-systems. The connection to the PC can be established via a USB-bUS interface set. This is available as an accessory, **"8.4. Ordering chart Accessories" on page 10**.

The Bürkert Communicator enables:

- Configuration, parameterisation and diagnosis of EDIP devices/networks
- Easy and convenient assignment (mapping) of cyclical values
- Graphical display of process values
- Firmware update of the connected EDIP devices
- Saving and restoring device configurations

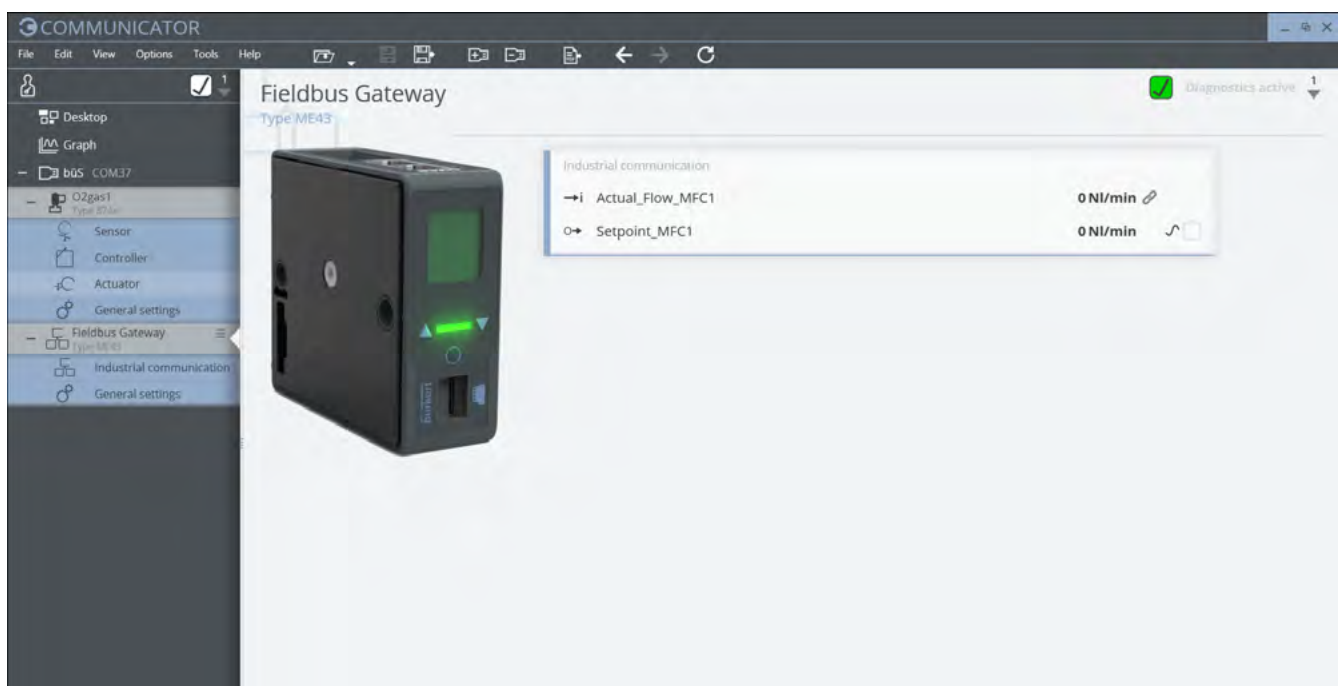

## 7. Networking and combination with other Bürkert products

**Note:**

Example of a network with gateway ME43 and MFCs

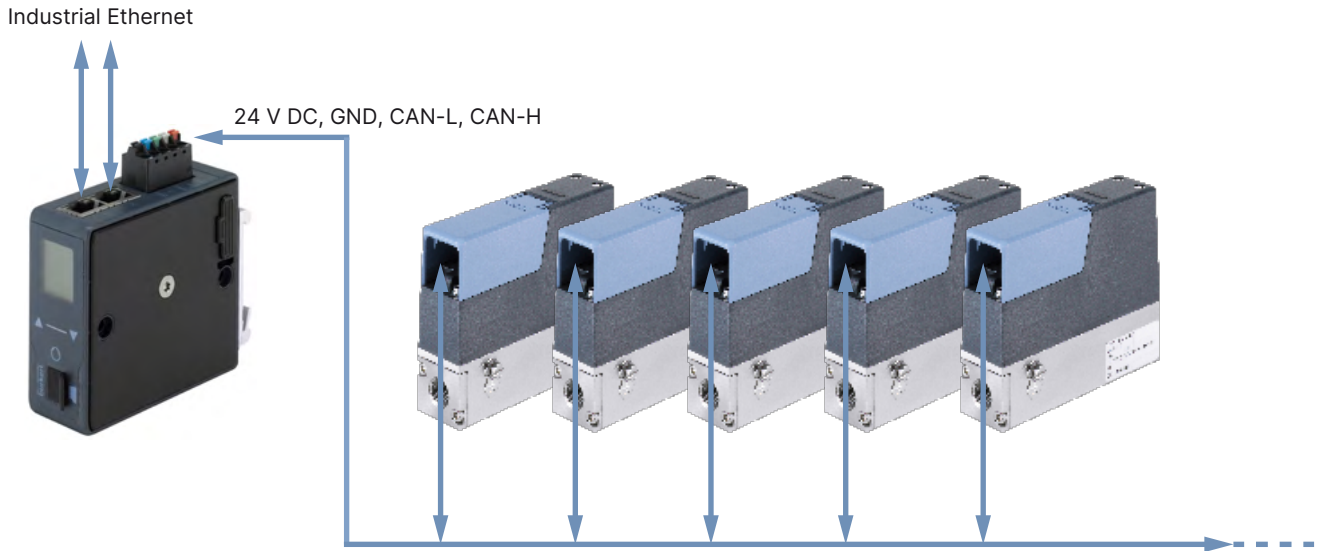

## 8. Ordering information

### 8.1. Bürkert eShop



**Bürkert eShop – Easy ordering and quick delivery**

You want to find your desired Bürkert product or spare part quickly and order directly? Our online shop is available for you 24/7. Sign up and enjoy all the benefits.

[Order online now](#)

### 8.2. Bürkert product filter



**Bürkert product filter – Get quickly to the right product**

You want to select products comfortably based on your technical requirements? Use the Bürkert product filter and find suitable articles for your application quickly and easily.





[Try out our product filter](#)

DTS 1000328369 EN Version: S Status: RL (released | freigegeben | valide) printed: 18.12.2024



### 8.3. Ordering chart

#### Note:

Please note that the ME43 gateway modules are not configured from the factory. However, these absolutely must be configured in order to be used in a system. The device description files must be generated with the Bürkert Communicator software before the start-up of a system. See **operating instructions Type ME43** ►.























Article	Article no. Standard
Gateway Type ME43 for Industrial Ethernet (PROFINET, Ethernet/IP, Modbus/TCP, EtherCAT, CC-Link IE Field Basic)	307390 
Gateway PROFINET S2	20065630 
Gateway Type ME43 for PROFIBUS DPV1	307393 
Gateway büS/CANopen	307391 
Gateway CC Link (RS-485)	307394 

#### Software Functions

Article	Article no.
License for graphical programming (only required for a running time > 60 minutes) <sup>1)</sup>	567713 
Batch Controller license for Type ME43 gateway <sup>1)</sup>	572948 

1.) The active runtime is limited to 60 min without the licence.

### 8.4. Ordering chart Accessories

Article	Article no.
büS cable extension, M12, cable length: 0.1 m	772492 
büS cable extension, M12, cable length: 0.2 m	772402 
büS cable extension, M12, cable length: 0.5 m	772403 
büS cable extension, M12, cable length: 1 m	772404 
büS cable extension, M12, cable length: 3 m	772405 
büS socket, M12, straight, A-coded <sup>1)</sup>	772416 
büS plug, M12, straight, A-coded <sup>1)</sup>	772417 
büS socket, M12, angled, A-coded <sup>1)</sup>	772418 
büS plug, M12, angled, A-coded <sup>1)</sup>	772419 
büS Y plug	772420 
büS Y plug for linking 2 separately supplied segments of a büS network	772421 
Termination resistor (directly pluggable)	303833 
büS plug, M12, terminating resistor 120 Ω	772424 
büS socket, M12, terminating resistor 120 Ω	772425 
Power supply unit Phoenix Class2 (Type 1573), 85...240 V AC/24 V DC, 1.25 A, NEC Class 2 (UL 1310)	772438 
Power supply unit for standard rail (Type 1573), 100...240 V AC/24 V DC, 1 A, NEC Class 2 (UL 1310)	772361 
Power supply unit for standard rail (Type 1573), 100...240 V AC/24 V DC, 2 A, NEC Class 2 (UL 1310)	772362 
Power supply unit for standard rail (Type 1573), 100...240 V AC/24 V DC, 3.8 A, NEC Class 2 (UL 60950 - 1)	772898 
Power supply unit for standard rail (Type 1573), 100...240 V AC/24 V DC, 10 A	772698 
Micro-SD card for fieldbus gateway Type ME43 and Type ME63	774087 
USB-büS-Interface Set 1 (Type 8923)	772426 
USB-büS-Interface Set 2 (Type 8923)	772551 
Bürkert Communicator Software	<b>Type 8920</b> ►

1.) For space reasons, M12 individual push-in connectors may not be suitable for simultaneous use on the same side as a Y distributor. Use a commercially available covered cable in this case.