



# SAFETY BEYOND LIMITS

SAFETY LASER SCANNERS FOR EFFICIENT PROCESSES

Safety laser scanners

**SICK**  
Sensor Intelligence.





## FOUR DIMENSIONS OF IMPRESSIVE SENSORS

### Reliable technology



Dust, dirt, ambient light – the safety laser scanners from SICK are at home in harsh industrial settings: The safeHDDM® scanning technology makes them extremely rugged. The patented safeHDDM® methodology also makes it possible to combine an ultra-compact design, large scanning range, and high-precision measurement data.

- ⊕ Avoid downtimes thanks to the high availability of the safety laser scanner

→ see page 6

### Intelligent functions



The sensor settings can be optimally adjusted to a wide range of different requirements with the help of intelligent functions, for example simultaneous protective fields or contour detection fields. All 128 available fields can be individually configured when doing so.

- ⊕ This configurability gives you a high level of flexibility

→ see page 8

# POWERFUL INNOVATION MEETS SAFETY EXPERTISE

Safety laser scanners enable humans and machines to work safely alongside one another in everyday industrial settings: They protect hazardous areas, hazardous points and access points both indoors and outdoors. With its microScan3, nanoScan3 and outdoorScan3 product families, SICK is pushing the boundaries of the possible. Ambient light, dirt, dust, rain, fog and snow are reliably filtered out thanks to the safeHDDM® technology. This opens up new fields of application for you, enables you to increase your productivity, and really raises the bar for safety laser scanners.



## Smart integration



Quick to mount, exchange and easy to wire: Configuration and diagnostics can be managed directly from the safety laser scanners or centrally within the industrial network. Depending on the variant, the devices can be integrated into industrial networks via I/Os or EtherNet/IP™ CIP Safety™, PROFINET PROFIsafe, EtherCAT® FSoE, EFI-pro and other interfaces.

- ⊕ Save time and money during mounting and commissioning

→ see page 10

## Intuitive operation



Complex technology, easy to use: The safety laser scanners can be quickly and easily configured using the license-free Safety Designer software. Important diagnostic data can be accessed directly on the device via pushbuttons or the display. Detailed diagnostic information on the safety laser scanners is also available in Safety Designer.

- ⊕ Benefit from the high usability achieved through sophisticated technology

→ see page 11

# FIND OUT MORE ABOUT OUR INNOVATIVE SAFETY LASER SCANNERS



### Indoor safety laser scanners

Concentrated safety expertise is part of the S3000, S300 and S300 Mini product variants: They have been continuously further developed over many years. The TiM-S safety laser scanner with performance level PL b rounds off the comprehensive sensor portfolio.

The microScan3 and nanoScan3 variants master challenges such as ambient light, dust and dirt as well as large scanning ranges with ease thanks to the safeHDDM® scanning technology. With smart connectivity options, intuitive operation, rugged design, and customizable settings, they are ideally equipped for your applications.

→ To find out more see pages 6-17

### Outdoor safety laser scanners

The outdoorScan3 builds on the product advantages of the microScan3 and has been adapted to handle challenging environmental influences. To achieve this, the outdoor safeHDDM® scanning technology was specially enhanced for outdoor applications. As a result, the outdoorScan3 is the first safety laser scanner to be certified for outdoor applications.

→ To find out more see pages 18-21



## HIGH RELIABILITY THANKS TO INNOVATIVE SCANNING TECHNOLOGY

The patented safeHDDM® (HDDM = High Definition Distance Measurement) scanning technology from SICK allows, for example, scanning ranges of up to 9 m and a scanning angle of 275°.

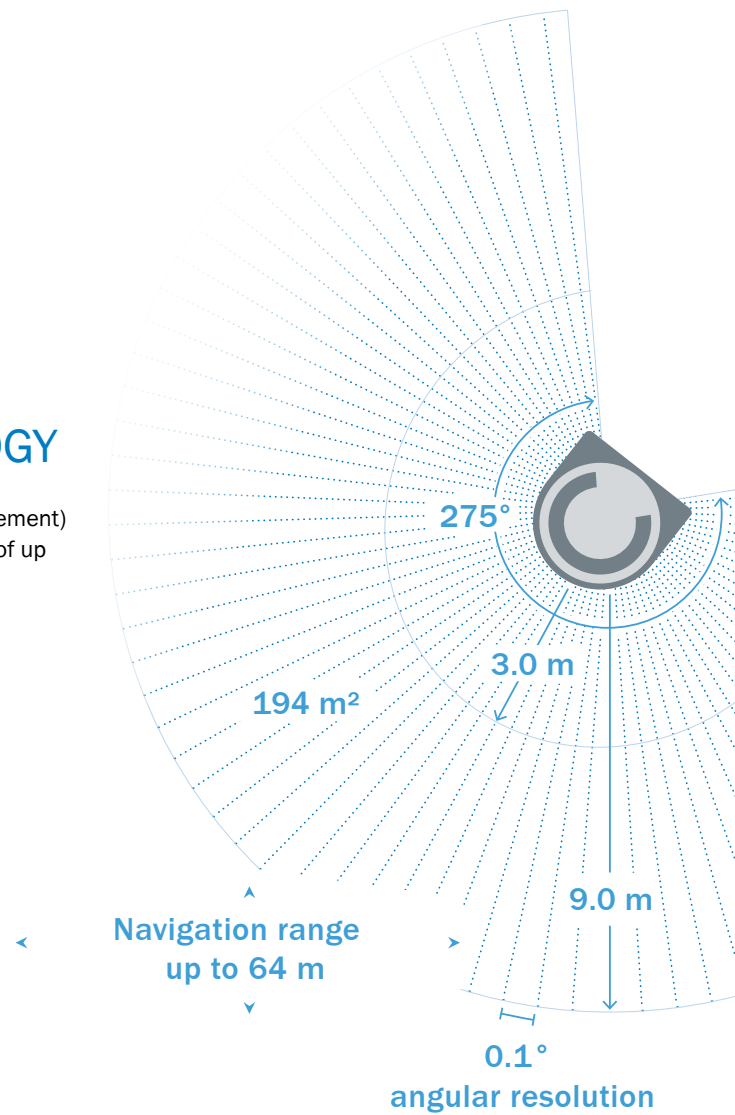

### safeHDDM® scanning technology

The technology detects the distance of objects based on the time-of-flight measurement. With 88,000 individual pulses, it emits significantly more laser pulses than a conventional scanner (approx. 500 pulses per scan cycle). Through optimal filtering and evaluation of this data with intelligent algorithms, the safeHDDM® scanning technology generates highly precise measured values.

Up to 2,750 values are produced per revolution. The safety laser scanner maintains its availability regardless of sources of interference such as ambient light, dirt, dust or sparks, thereby avoiding switching errors.

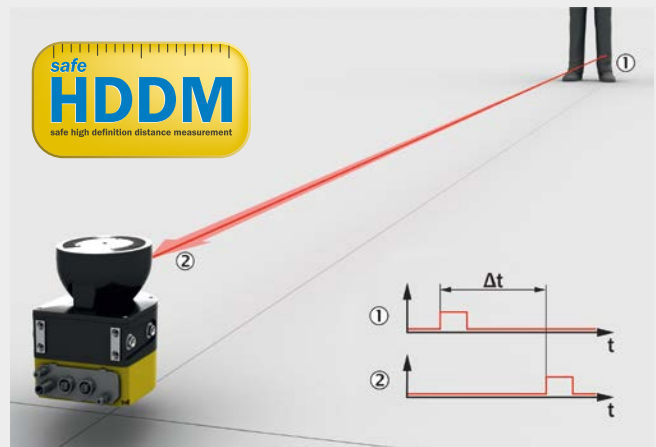





### Highlights

- Increased productivity thanks to protective field range of 9 m
- High availability: resistant to dust, dirt and ambient light
- Highly precise measurement data for exact localization
- Space-saving due to ultra-compact design

### The advantages of safeHDDM® at a glance

- Safe leg detection even at a distance of 9 m due to the high angular resolution of 0.1°
- No safety gaps even if the device is mounted in a corner thanks to the 275° scanning angle
- The large protective field range enables automated guided vehicle systems to operate at high speeds and reduces the number of devices needed to protect larger areas

#### More information about safeHDDM®:

→ <https://youtu.be/mEQoyOptyy4>

### Compact and rugged design

- The scanning technology allows large scanning ranges with a compact design. This enables the nanoScan3 to even fit under a Euro pallet
- Reduced maintenance costs: High mechanical resistance thanks to rugged aluminum die-cast housing
- High productivity thanks to trouble-free operation: The mounting systems used are vibration- and shock-tested
- High availability: Machine downtimes are reduced thanks to the high electromagnetic compatibility (EMC) of the device

#### More information on ruggedness:

→ <https://youtu.be/ui2nwQS2coU>



## INTELLIGENT FUNCTIONS FOR NUMEROUS POSSIBILITIES

The demands on the economic efficiency of laser scanners, and therefore on efficient, uninterrupted processes, are high. With the intelligent functions of the microScan3 and nanoScan3 product families from SICK, safety and productivity go hand-in-hand. You can tailor the safety laser scanners to a diverse range of tasks and machine environments, thereby ensuring processes run smoothly. All functions can be easily configured in the Safety Designer software.

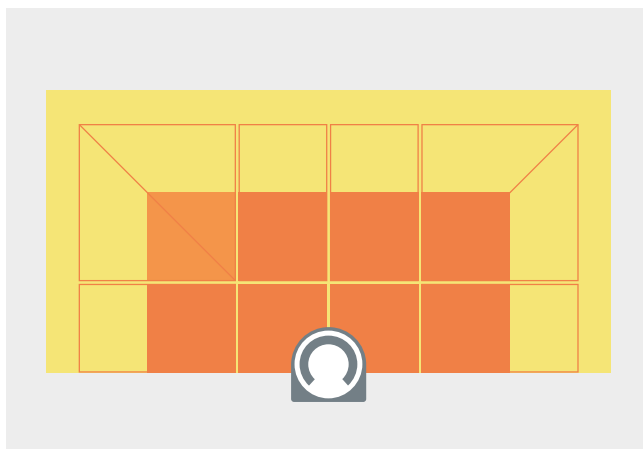

### 128 freely-configurable fields, 8 simultaneous protective fields

- With up to 128 fields and monitoring cases, you can flexibly adjust the sensor settings to the current requirements. In the case of mobile applications, for example, to specific speeds, loads or curves
- Cost-efficient protection of hazardous areas: Simultaneous protective field evaluation enables a single scanner to monitor up to 8 protective fields

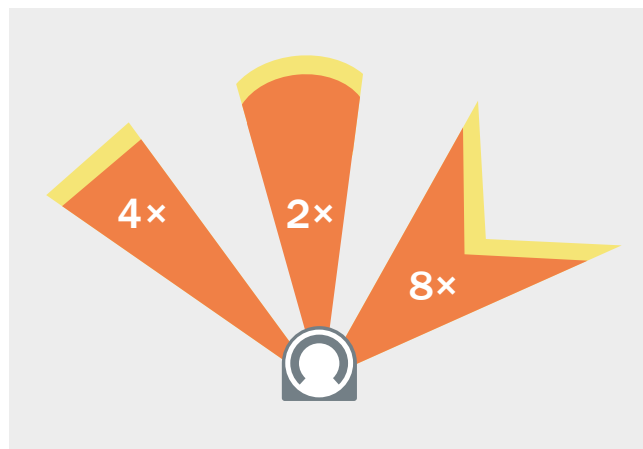

### Individual field settings

- Multiple sampling and object resolution can be individually defined for each field, including simultaneous protective fields, thereby enabling you to precisely tailor the settings to the ambient conditions
- Numerous additional background functions such as reliable case switching ensure a high level of productivity. The number of scans required immediately after field switching can be individually defined, which reduces switching errors





## Highlights

- Central commissioning and diagnostics thanks to network technology
- Flexibility through 128 freely-configurable fields
- Simultaneous monitoring of up to 8 protective fields reduces the number of devices required
- Protection and measurement data for navigation support using just one device
- Fewer switching errors thanks to individually configurable multiple sampling and additional functions such as reliable case switching
- Increased safety through monitoring of the machine environment using a contour detection field
- Host/guest functionality for easy connection of up to 4 devices
- Dynamic control inputs allow speed-dependent case switching

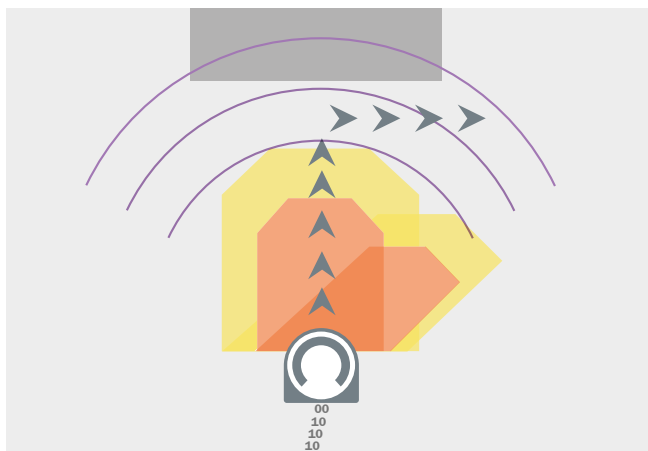

## Measurement data for navigation support

- The microScan3 precisely records its environment within a scanning range of 64 m. It makes the acquired measurement data accessible via Ethernet for navigation support
- Thanks to its 0.1° angular resolution, the microScan3 delivers a variety of navigational data for a remarkably clear environmental image and exceptional contour recognition as well as reflector localization

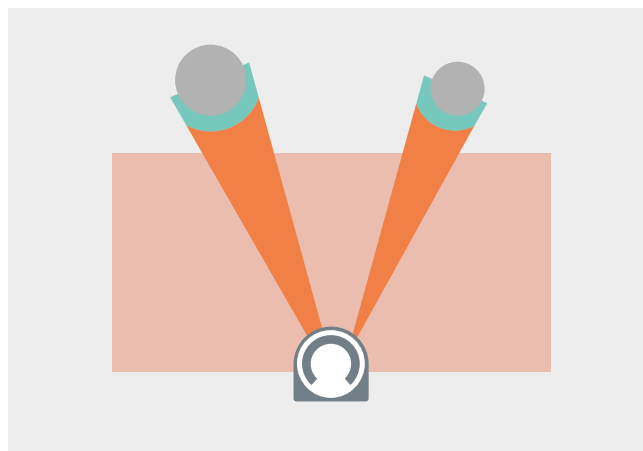

## Contour detection field

- When the safety laser scanner detects a previously defined contour, an automated guided vehicle system, for example, can tailor its response accordingly. It can detect the loading position, an aisle entrance, or a change in warehouse reliably and without the need for additional sensors, e.g., to safely adjust the vehicle speed



## SMART INTEGRATION CAN BE THIS SIMPLE

Safety laser scanners are remarkably uncomplicated to incorporate into your application: quick to mount, easy to wire, and able to be safely integrated into industrial networks.



### Quick mounting, standardized cabling

The standardized M12 connectivity enables you to mount the laser scanner quickly and inexpensively. Optical fiber variants are available for particularly demanding EMC environments.



### Safe network integration

The safety laser scanners from SICK can be easily and safely integrated into industrial networks such as EtherNet/IP™ CIP Safety™, PROFINET PROFI-safe or EtherCAT® FSoE.

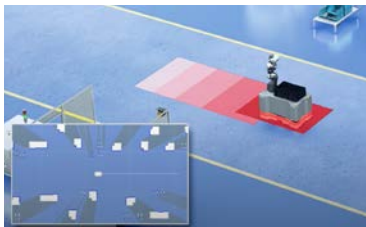

### Easy integration of measurement data

SICK offers drivers for easy integration of measurement data into common robotics programming environments (C++, ROS, NVIDIA Isaac SDK™).



### Quick device exchange

The configuration is saved in the system plug. This means that if the safety laser scanner gets damaged, you only need to exchange it and the cabling remains the same.



## INTUITIVE OPERATION INTELLIGENT SENSOR TECHNOLOGY

Using the Safety Designer software, you can quickly and easily configure the safety laser scanner as well as access detailed diagnostics information. Important diagnostic data are also available directly on the device on the display.



### Diagnostics directly available on the device

You can obtain important diagnostic data quickly via the display and the well visible LEDs. You can also access detailed information conveniently over the network.

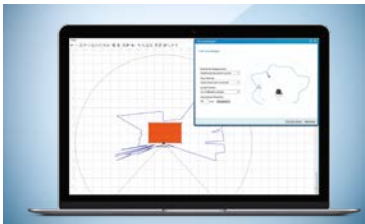

### Easy operation of the Safety Designer software

Configuration and diagnostics are performed via the easy-to-use Safety Designer software and using a convenient step-by-step configuration assistant.

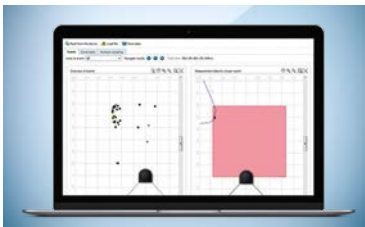

### Process and configuration optimization by analyzing object detections

Measurement data can be stored, analyzed and used to assist optimization. This avoids unscheduled machine downtimes.



### Easy fault analysis: The EventCam shows what happened

The freely-positionable camera records the period of time before and after a protective field interruption and visualizes the cause of false trips.





## INDUSTRY 4.0 IS PICKING UP SPEED: SAFETY LASER SCANNERS FOR AUTOMATED GUIDED VEHICLES

Automated guided vehicles (AGVs) will be essential for the intelligent, fully-networked factory of the future – they make production processes more flexible and efficient. The special requirements of these mobile applications are continuously fed into the development processes for SICK safety laser scanners. With a range of clever features and functions, SICK is preparing the industrial vehicle for Industry 4.0.



### Navigation and localization

When using independent localization via reflectors or surrounding contours, the vehicle determines its absolute position. Thanks to the exceptional quality of the values measured with an angular resolution of up to  $0.1^\circ$ , the measurement data of the safety laser scanner are optimally suited for AGV navigation. The data can be exchanged between the vehicles via Ethernet - vehicles can communicate with each other and processes can be adapted to one another.

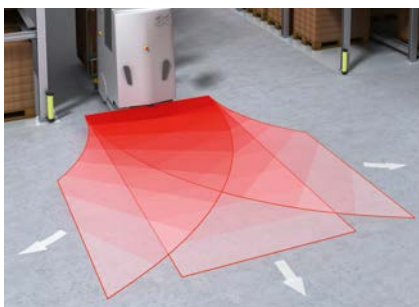

### Perfect for cornering and high speeds

The protective fields of the safety laser scanner are ideally suited for cornering and parking: The 128 freely-configurable fields and 8 simultaneous protective fields enable the system to be flexibly adapted to the local environment. Thanks to the simultaneous protective fields, it is possible for the AGVs to reduce their speed incrementally. The protective field range of 9 m allows the AGVs to move at high speeds, thereby increasing throughput and boosting productivity.

### Highlights

- Localization and navigation using precise measurement data
- Optimal adjustment to ambient conditions thanks to 128 freely-configurable fields and 8 simultaneous protective fields
- Fast speeds and high productivity thanks to a large protective field range of up to 9 m
- High availability of AGVs and increased productivity thanks to safe motion control
- Ultra-compact nanoScan3 for easy integration

### Safe speed monitoring for AGVs: Safe Motion

With its systems for safe motion control, such as the Safe EFI-pro System, SICK offers you convenient, complete solutions for the safe detection and control of the speed and driving direction of automated guided vehicle systems. The Safe EFI-pro system, which comprises microScan3 safety laser scanners and a Flexi Soft safety controller, can be connected optimally to the AGV controllers. With information on speed and driving direction, the Safe EFI-pro system switches the fields, ensuring that the AGV always drives at the right speed, in the right direction.

**Additional information:**

→ [www.sick.com/safe-motion](http://www.sick.com/safe-motion)



### Space-saving laser scanner for small AGVs: nanoScan3

The miniaturization of high-precision and extremely rugged safety laser scanners continues: The nanoScan3 from SICK with its small installation size is opening up new possibilities in the design of small automated guided vehicles. The sensor is so compact that it even fits under a pallet.

**Additional information:**

→ [www.sick.com/nanoScan3](http://www.sick.com/nanoScan3)

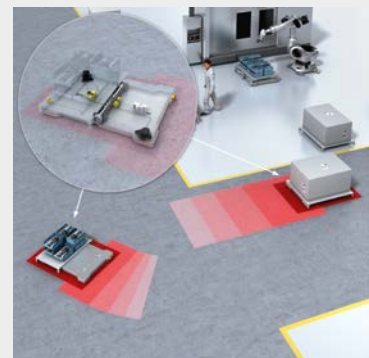





## WORKING TOGETHER AS EQUALS: SAFETY LASER SCANNERS FOR ROBOTICS

The close and, at the same time, safe collaboration between humans and robots on an equal footing is the prerequisite for high productivity, increasing efficiency, and improved ergonomics. Safety technology thereby plays a key role. The safe safety systems from SICK reliably protect against the hazards of this close teamwork, making it possible for humans and machines to work together both safely and efficiently.



### Safety systems specifically for robotics applications

Collaboration between humans and machines can be implemented efficiently and conveniently with the help of safety systems such as Safe Robotics Area Protection or the Safe EFI-pro system. They combine a safety laser scanner with a safety controller and, thanks to the comprehensive documentation and control logic, can be easily integrated into robot controllers. These safety systems are also available in manufacturer-specific variants, e.g., for robots from Universal Robots (UR), Yaskawa or FANUC.



## Safe Robotics

### Safe and productive: SICK sensor solutions for robotics

The prerequisite for safe, productive human-robot collaborations is intelligent sensors and sensor systems – they enable humans to intervene in the robot system unimpeded. As the leading expert in safety technology, SICK makes companies fit for Industry 4.0 and is also a reliable partner in Safe Robotics. From initial consultation to global onsite support from our safety experts, SICK offers a wide portfolio of sensor solutions and services for efficient human-robot collaboration.

#### Additional information:

→ [www.sick.com/safe-robotics](http://www.sick.com/safe-robotics)

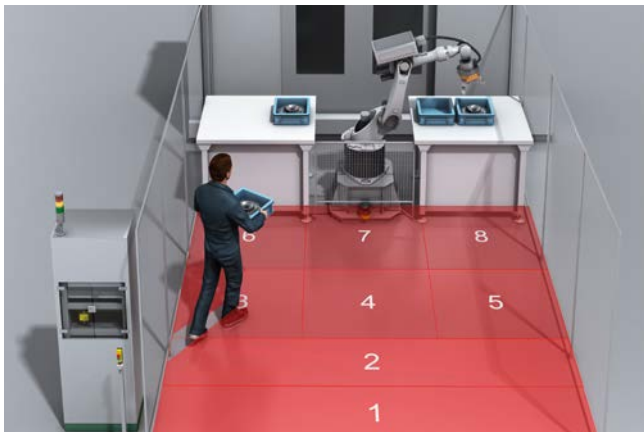

### Human machine cooperation

A robot works in one area, a worker walks in another: In human-robot collaboration, the safety laser scanner's simultaneous fields enable various robot motions to be protected with just one device. Sequence monitoring can be used to detect which direction a person is walking. If a person approaches the robot, the robot first reduces its work speed instead of coming to an immediate stop.

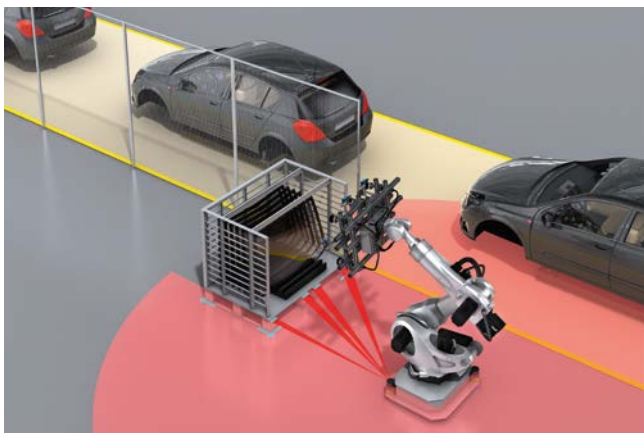

### Reliable and automated object detection

The contour detection field is used to safely determine the position of objects in a previously defined environment. The safety laser scanner detects, e.g. by means of a previously programmed surrounding contour, whether a robot is in its prescribed docking position. The protective fields can then be adjusted as required. No additional sensors for position detection are therefore required, which saves you costs for position switches.



## Portal protection

# FLEXIBLE AND RELIABLE PROTECTION OF ACCESS PASSAGES

Humans and machines work together in close spaces in production lines: Automated guided vehicle systems supply automated material transition stations, robots and workers do mounting work in the same production cells. Safe Portal Solutions from SICK differentiates between human and material: While all movements are stopped when the worker enters the hazardous area, the automated guided vehicle system can pass through the access passage without problems. The result: Flexible processes and easily-adaptable production.

## Highlights

- Seamless production processes by storing predefined vehicle contours in the safety solution
- Flexible processes through rapid, safe switching between fields
- Easy, adaptable production processes because the sender and receiver are integrated into a single device
- Cost savings as fewer laser scanners are needed



## Reliable object detection using the measurement data

Based on precise measurement data, the safety solution detects objects using predefined contours stored in the device. For further processing, the safety solution transmits the data to the machine controller. This makes it possible to differentiate between human and material.



## Flexibility and safety due to simultaneous protective fields with individual fields settings

The customized adjustments and simultaneous fields on the safety solution enable quick, safe switching between the individual fields. The individual field settings on the safety solution are available without restrictions even if simultaneous fields are used.



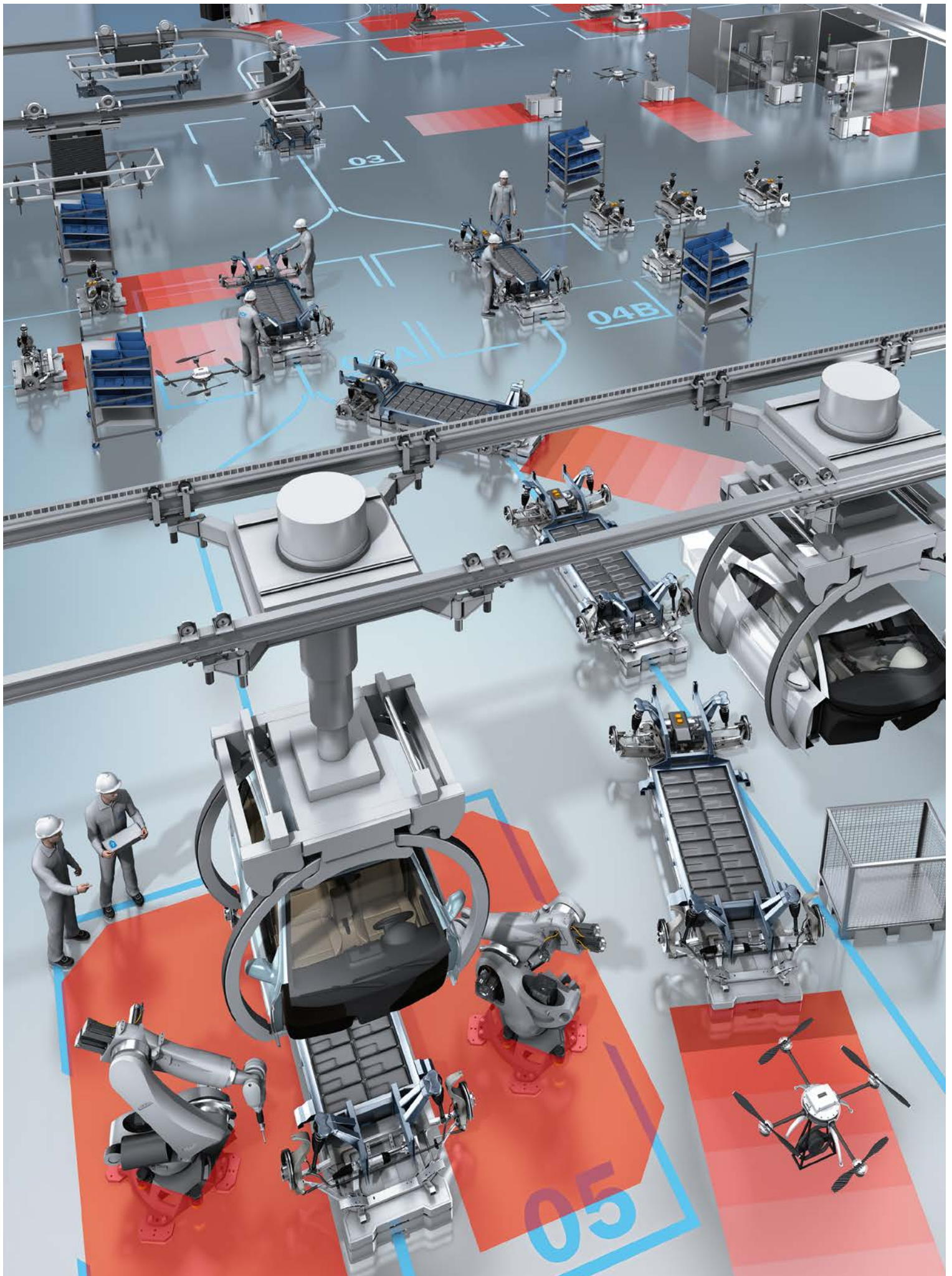





Sunlight



Rain



Snow



Fog

### Facing challenging weather conditions

The outdoorScan3 works safely and reliably, even under challenging weather conditions. No matter if there's sun, rain, fog, or snow, outdoorScan3 takes personal safety and productivity to a new level – regardless of potentially disruptive factors. With the optional AGV Dynamic Weather Assist, the outdoorScan3 also reacts dynamically to changing weather conditions.

⊕ You are well-prepared for any weather with reliable safety technology from SICK

# MOVING BEYOND LIMITS

The world's first IEC 62998-certified safety laser scanner for indoor and outdoor use opens up a whole new world of easy and safe outdoor automation.

With the outdoorScan3, people and machines can now work outside together safely. This leads to higher AGV (Automated Guided Vehicles) speeds and a continuous material flow between several production halls. Quite simply, the outdoorScan3 enables you to increase your productivity both indoors and outdoors.



## Additional information:

→ [www.sick.com/outdoorScan3](http://www.sick.com/outdoorScan3)

### Outdoor certified



The outdoorScan3 is designed to allow man and machine to work safely side by side and is certified for use in industrial production and logistics areas both inside and outside of buildings. This certification is based on the ISO 13849-1 and IEC 62998 standards, among others.

⊕ Increase your productivity outdoors with safe human-machine cooperation

### Outdoor safeHDDM® scanning technology



The outdoorScan3 is exceptionally suitable for protecting both stationary and mobile outdoor applications. The patented safeHDDM® technology from SICK used in the safety laser scanner has been specifically enhanced for outdoor applications through the addition of special algorithms. It reliably detects people without the need for additional protective devices.

⊕ You will be impressed with its high availability, even in unfavorable weather conditions

## outdoorScan3 – FOR DIVERSE FIELDS OF APPLICATION

### Productivity increase with AGV Dynamic Weather Assist



More than 80% fewer rain-related switch-offs\*



More than 95% fewer snow-related switch-offs\*



### Greater availability of AGVs due to weather-dependent speed adjustment

The safety requirements for mobile applications in outdoor areas are demanding: Personal safety must be ensured at all times in all weather conditions, even if the laser scanner gets dirty. At the same time, unplanned machine stops should be reduced.

The AGV Dynamic Weather Assist function block of the Flexi Soft safety controller makes it possible to adapt protective fields to changing weather conditions. The outdoorScan3 thus supports automated speed adjustments for the seamless connection of production and logistics processes in both indoor and outdoor environments.

\*The efficiency of the AGV Dynamic Weather Assist was examined in a long-term stationary test over a period of 12 months at the Outdoor Technology Center. The evaluation showed a significant increase in availability of the outdoorScan3 when used with the AGV Dynamic Weather Assist.

For more information on the AGV Dynamic Weather Assist, visit [→ www.sick.com/AGV\\_Dynamic\\_Weather\\_Assist](https://www.sick.com/AGV_Dynamic_Weather_Assist)

### Hazardous area protection for stationary applications

From basic safety mat replacement and presence detection through to protecting multiple hazardous areas at the same time, the outdoorScan3 is always the ideal choice. Suitable horizontal protective fields can be set up and monitored to protect against the dangers posed by hazardous machines, plants or open spaces. As we move towards the Smart Factory, we find humans, machines and autonomous systems working ever closer together. Safety for humans is always a primary focus, without ever losing sight of productivity.





### Continuous status monitoring

The Monitoring Box from SICK is a browser application that lets you administer the sensor and machine data and visualize it in a dashboard. Status changes can be easily monitored and quickly diagnosed.

If necessary, an alert can be sent in the event of any significant change in the device status. This enables operators to intervene in a timely manner. This ensures the availability and productivity of your system.

#### Additional information on the Monitoring Box

→ [www.sick.com/monitoring-box](http://www.sick.com/monitoring-box)



## YOUR PARTNER FOR PRODUCTIVE OUTDOOR SAFETY SOLUTIONS

Once the foundations have been laid and the legal framework has been defined, you then have various options available when it comes to safely automating processes in the outdoor area. SICK can help you protect your individual applications.

### Normative requirements

Machine safety is a crucial consideration for the outdoorScan3. In this context, the ISO 13849-1 safety standard defines the range of application for the laser scanner.

By applying IEC62998 in a systematic manner, it is possible to expand the intended use of the outdoorScan3 in outdoor areas.

### Application requirements

To achieve the perfect balance between a high level of safety and a high level of availability, the environmental influences on the application as well as the installation conditions of the machine must be considered. This is particularly important for outdoor applications to ensure the expected availability is achieved.

### Applications

- Industrial production and logistics areas
- Non-public areas: Access for authorized personnel only
- Moderate environmental conditions (similar to the temperate climates defined in IEC 60721-2-1, for example)

CREATING  
SAFE  
PRODUCTIVITY

		<b>Protective field range</b> The protective field range describes the maximum range of the monitored field.	<b>Scanning angle</b> The scanning angle describes the maximum viewing angle of the safety laser scanner.
Indoor	<b>microScan3</b> The rugged safety laser scanner – extremely intelligent		
	<b>nanoScan3</b> The smallest safety laser scanner from SICK – extremely rugged and highly precise		
	<b>S3000</b> Powerful and modular		
	<b>S300</b> Compact – all functions in a single device		
	<b>S300 Mini</b> Ultra-compact – focused on the essentials		
	<b>TIM-S</b> The option for applications with safety level PL b		
	<b>outdoorScan3</b> The safety laser scanner for outdoor automation		

**Fields**

The number of fields indicates how flexibly the laser scanner can be adapted to different process phases.

**Dimensions (width × height × depth)**

The more compact the device, the simpler it is to integrate into the machine design.

**Measurement data output**

The surrounding contour recorded is available for different interfaces for uses such as vehicle navigation.

**Integration**

Safe integration into the machine controller can take place via various interfaces.

**Performance level**

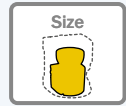

110 mm × 135 mm × 110 mm

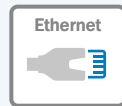

I/Os,  
EFI-pro,  
PROFINET PROFI-safe,  
EtherNet/IP™  
CIP Safety™,  
EtherCAT® FSoE

**PL d**



101 mm × 80 mm × 101 mm

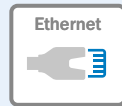

I/Os

**PL d**

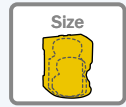
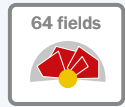

155 mm × 185 mm × 160 mm

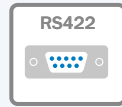

I/Os,  
EFI,  
PROFINET PROFI-safe

**PL d**

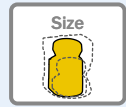
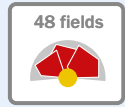

102 mm × 152 mm × 106 mm

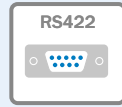

I/Os,  
EFI

**PL d**

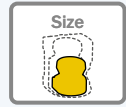
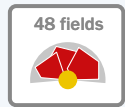

102 mm × 116 mm × 104 mm

I/Os,  
EFI

**PL d**

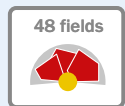

60 mm × 86 mm × 60 mm

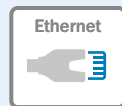

I/Os

**PL b**

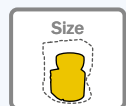

110 mm × 135 mm × 110 mm

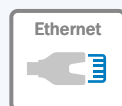

I/Os,  
EtherNet/IP™  
CIP Safety™

**PL d**





microScan3

→ [www.sick.com/microScan3](http://www.sick.com/microScan3)

Ordering information

Integration in the control	Variant	Protective field range	Number of fields	Number of monitoring cases	Connection type	Type	Part no.
Local inputs and outputs (I/O)	microScan3 Core I/O	4 m	8	2	M12	MICS3-AAA-Z40AZ1P01	1075842
		5.5 m	8	2	M12	MICS3-AAA-Z55AZ1P01	1075843
		9 m	8	2	M12	MICS3-AAA-Z90AZ1P01	1089492
	microScan3 Core I/O AIDA	4 m	4	1	M12	MICS3-AAA40B-Z1P01	1083078
		5.5 m	4	1	M12	MICS3-AAA455B-Z1P01	1083079
		9 m	4	1	M12	MICS3-AAA490B-Z1P01	1089493
	microScan3 Pro I/O	4 m	128	128	M12	MICS3-CCA-Z40AA1P01	1110035
		5.5 m	128	128	M12	MICS3-CCA-Z55AA1P01	1110033
		9 m	128	128	M12	MICS3-CCA-Z90AA1P01	1110037
CIP Safety™ via EtherNet/IP™	microScan3 Core – EtherNet/IP™	4 m	8	8	M12	MICS3-ABA-Z40IZ1P01	1082015
		5.5 m	8	8	M12	MICS3-ABA-Z55IZ1P01	1082016
		9 m	8	8	M12	MICS3-ABA-Z90IZ1P01	1094457
	microScan3 Pro – EtherNet/IP™	4 m	128	128	M12	MICS3-CBA-Z40IZ1P01	1092542
		5.5 m	128	128	M12	MICS3-CBA-Z55IZ1P01	1092543
		9 m	128	128	M12	MICS3-CBA-Z90IZ1P01	1094461
EtherCAT® FSoE	microScan3 Core – EtherCAT®	4 m	8	8	M12	MICS3-ABA-Z40EN1P01	1108230
		5.5 m	8	8	M12	MICS3-ABA-Z55EN1P01	1108232
		9 m	8	8	M12	MICS3-ABA-Z90EN1P01	1108234
	microScan3 Pro – EtherCAT®	4 m	128	128	M12	MICS3-CBA-Z40EN1P01	1108226
		5.5 m	128	128	M12	MICS3-CBA-Z55EN1P01	1103950
		9 m	128	128	M12	MICS3-CBA-Z90EN1P01	1108228
EFI-pro	microScan3 Core – EFI-pro	4 m	8	8	M12	MICS3-ABA-Z40ZA1P01	1092539
		5.5 m	8	8	M12	MICS3-ABA-Z55ZA1P01	1092538
		9 m	8	8	M12	MICS3-ABA-Z90ZA1P01	1094455

Integration in the control	Variant	Protective field range	Number of fields	Number of monitoring cases	Connection type	Type	Part no.
EFI-pro	microScan3 Pro – EFI-pro	4 m	128	128	M12	MICS3-CBA-Z40ZA1P01	1091037
		5.5 m	128	128	M12	MICS3-CBA-Z55ZA1P01	1091038
		9 m	128	128	M12	MICS3-CBA-Z90ZA1P01	1094465
PROFINET PROFI-safe	microScan3 Core – PROFINET	4 m	8	8	SCRJ push-pull (optical fiber)	MICS3-ACA-Z40LZ1P01	1100384
					RJ45 push-pull (copper)	MICS3-ACAZ-40PZ1P01	1083012
					M12	MICS3-ABA-Z40PZ1P01	1100404
		5.5 m	8	8	SCRJ push-pull (optical fiber)	MICS3-ACA-Z55LZ1P01	1100386
					RJ45 push-pull (copper)	MICS3-ACAZ-55PZ1P01	1083010
					M12	MICS3-ABA-Z55PZ1P01	1100406
		9 m	8	8	SCRJ push-pull (optical fiber)	MICS3-ACA-Z90LZ1P01	1100388
					RJ45 push-pull (copper)	MICS3-ACAZ-90PZ1P01	1094459
					M12	MICS3-ABA-Z90PZ1P01	1100408
	microScan3 Pro – PROFINET	4 m	128	128	SCRJ push-pull (optical fiber)	MICS3-CCA-Z40LZ1P01	1100398
					RJ45 push-pull (copper)	MICS3-CCA-Z40PZ1P01	1100390
					M12	MICS3-CBA-Z40PZ1P01	1092720
		5.5 m	128	128	SCRJ push-pull (optical fiber)	MICS3-CCA-Z55LZ1P01	1100400
					RJ45 push-pull (copper)	MICS3-CCA-Z55PZ1P01	1100392
					M12	MICS3-CBA-Z55PZ1P01	1092721
		9 m	128	128	SCRJ push-pull (optical fiber)	MICS3-CCA-Z90LZ1P01	1100402
					RJ45 push-pull (copper)	MICS3-CCA-Z90PZ1P01	1100394
					M12	MICS3-CBA-Z90PZ1P01	1094463

Accessories required for commissioning

Description	Quantity	Scope of delivery	More information	microScan3 Core					micro-Scan3 Pro		
				I/O	I/O AIDA	EtherNet/IP™	PROFINET	EFI-p/ro	EtherNet/IP™	PROFINET	EFI-p/ro
Mounting kit	1	-	→ Mounting brackets and plates	●	●	●	●	●	●	●	●
Connection cable	1	-	→ <a href="http://www.sick.com/microscan3_core">www.sick.com/microscan3_core</a> → <a href="http://www.sick.com/microscan3_pro">www.sick.com/microscan3_pro</a>	●	●	●	●	●	●	●	●
Connection cable for configuration and diagnostics	1	-	→ <a href="http://www.sick.com/microscan3_core">www.sick.com/microscan3_core</a>	●	●	-	-	-	-	-	-
Safety Designer (configuration and diagnostic software)	1	-	→ <a href="http://www.sick.com/safety_designer">www.sick.com/safety_designer</a>	●	●	●	●	●	●	●	●
Operating instructions	1	-	→ <a href="http://www.sick.com/downloads">www.sick.com/downloads</a>	●	●	●	●	●	●	●	●

Recommended software







Software	Description	More information
Safety Laser Scanner Visualization	Software solution for Windows-based SCADA systems (e.g., WinCC) and Windows PCs for real-time visualization and analysis of diagnostic and device information for all safety laser scanners connected via the network.	→ <a href="http://www.sick.com/safety_laser_scanner_visualization">www.sick.com/safety_laser_scanner_visualization</a>
microScan3 Monitoring App	The Monitoring app is a browser application that enables sensor and machine data to be visualized in a dashboard, and error states to be diagnosed and monitored.	→ <a href="http://www.sick.com/1614149">www.sick.com/1614149</a>



## Recommended accessories

## Mounting systems

## Mounting brackets and plates

Figure	Description	Packing unit	Type	Part no.
	Mounting bracket	1 item	Mounting kit 1a	2073851
	Mounting bracket with optics cover protection	1 item	Mounting kit 1b	2074242
	Alignment bracket, alignment with cross-wise axis and depth axis possible, distance between mounting surface and device: 22.3 mm, only in conjunction with mounting kit 1a (2073851) or 1b (2074242)	1 item	Mounting kit 2a	2073852
	Alignment bracket, alignment with cross-wise axis and depth axis possible, distance between mounting surface and device: 52.3 mm, only in conjunction with mounting kit 1a (2073851) or 1b (2074242)	1 item	Mounting kit 2b	2074184
	Mounting bracket, heavy-duty version, with protection cover, for floor mounting, height adjustment possible from 90 ... 310 mm, scanner tilt angle: $\pm 5^\circ$ . Additional mounting brackets are not required. Steel, lacquered (RAL 1021)	1 item	Heavy duty mounting kit for floor mounting	2102289
	150 mm bracket for microScan3 for floor mounting, bracket and 4 x M5 screws for attaching the microScan3	1 item	150 mm bracket for microScan3 for floor mounting	2112950
	300 mm bracket for microScan3 for floor mounting, bracket and 4 x M5 screws for attaching the microScan3	1 item	300 mm bracket for microScan3 for floor mounting	2112951



nanoScan3

→ [www.sick.com/nanoScan3](http://www.sick.com/nanoScan3)

Ordering information

Variant	Integration in the control	Protective field range	Number of fields	Type	Part no.
nanoScan3 Core I/O	Local inputs and outputs (I/O)	3 m	8	NANS3- AAAZ30AN1	1100333
nanoScan3 Pro I/O	Local inputs and outputs (I/O)	3 m	128	NANS3- CAAZ30AN1	1100334

The system plug has to be ordered separately!





Accessories required for commissioning

Description	Quantity	Scope of delivery	More information
Mounting kit	1	-	→ Mounting brackets and plates
System plug	1	-	→ Plug connectors and cables
Connection cable for configuration and diagnostics	1	-	→ <a href="http://www.sick.com/nanoScan3">www.sick.com/nanoScan3</a>
Safety Designer (configuration and diagnostic software)	1	-	→ <a href="http://www.sick.com/safty_designer">www.sick.com/safty_designer</a>
Operating instructions	1	-	→ <a href="http://www.sick.com/nanoScan3">www.sick.com/nanoScan3</a>

## Recommended accessories







### Mounting systems

#### Mounting brackets and plates

Figure	Description	Packing unit	Type	Part no.
	Mounting bracket	1 unit	Mounting kit 1a	2111767
	Mounting bracket with optics cover protection	1 unit	Mounting kit 1b	2111768
	Alignment bracket, alignment with cross-wise axis and depth axis possible	1 unit	Mounting kit 2a	2111769
	Alignment bracket with protection for the optics cover, alignment with cross-wise axis and depth axis possible	1 unit	Mounting kit 2b	2111770

### Connection technology

#### Plug connectors and cables

Figure	Description	Type	Part no.
	System connection; voltage supply: M12 male connector, 8-pin, A-coded	NANSX-AAABZZZZ1	2105106
	System connection; voltage supply: M12 male connector, 8-pin, A-coded, Ethernet: M12 female connector, 4-pin, D-coded	NANSX-AAABAEZZ1	2104949
	System connection; voltage supply: M12 male connector, 17-pin, A-coded	NANSX-AAACZZZZ1	2105107
	System connection; voltage supply: M12 male connector, 17-pin, A-coded, Ethernet: M12 female connector, 4-pin, D-coded	NANSX-AAACAEZZ1	2104860
	System connection; voltage supply: Flying leads, 17-wire	NANSX-AACCZZZZ1	2105109
	System connection; voltage supply: Flying leads, 17-wire, Ethernet: M12 female connector, 4-pin, D-coded	NANSX-AACCAEZZ1	2105108





## S3000

- [www.sick.com/S3000\\_Standard](http://www.sick.com/S3000_Standard)
- [www.sick.com/S3000\\_Advanced](http://www.sick.com/S3000_Advanced)
- [www.sick.com/S3000\\_Professional](http://www.sick.com/S3000_Professional)
- [www.sick.com/S3000\\_Expert](http://www.sick.com/S3000_Expert)
- [www.sick.com/S3000\\_Remote](http://www.sick.com/S3000_Remote)
- [www.sick.com/S3000\\_PROFINET\\_IO\\_Advanced](http://www.sick.com/S3000_PROFINET_IO_Advanced)
- [www.sick.com/S3000\\_PROFINET\\_IO\\_Professional](http://www.sick.com/S3000_PROFINET_IO_Professional)

### Ordering information

Variant	Protective field range	Number of fields	Connection type	Type	Part no.
S3000 Standard	4 m	4	System plug with or without connecting cable	S30A-4011BA	1028934
	5.5 m	4		S30A-6011BA	1023546
	7 m	4		S30A-7011BA	1023890
S3000 Advanced	4 m	12	System plug with or without connecting cable	S30A-4011CA	1028935
	5.5 m	12		S30A-6011CA	1023547
	7 m	12		S30A-7011CA	1023891
S3000 Professional	4 m	24	System plug with or without connecting cable	S30A-4011DA	1028936
	5.5 m	24		S30A-6011DA	1019600
	7 m	24		S30A-7011DA	1023892
S3000 Expert	4 m	64	System plug with or without connecting cable	S30A-4011GB	1052107
	5.5 m	64		S30A-6011GB	1052108
	7 m	64		S30A-7011GB	1052109
S3000 Remote	4 m	64	System plug with or without connecting cable	S30A-4011EA	1028938
	5.5 m	64		S30A-6011EA	1023548
	7 m	64		S30A-7011EA	1023893
S3000 PROFINET IO Advanced	4 m	8	Optical fiber <sup>1)</sup>	S30A-4111CL	1052591
			Copper cable <sup>2)</sup>	S30A-4111CP	1045650
	5.5 m	8	Optical fiber <sup>1)</sup>	S30A-6111CL	1052593
			Copper cable <sup>2)</sup>	S30A-6111CP	1045652
	7 m	8	Optical fiber <sup>1)</sup>	S30A-7111CL	1052595
			Copper cable <sup>2)</sup>	S30A-7111CP	1045654
S3000 PROFINET IO Professional	4 m	16	Optical fiber <sup>1)</sup>	S30A-4111DL	1052592
			Copper cable <sup>2)</sup>	S30A-4111DP	1045651
	5.5 m	16	Optical fiber <sup>1)</sup>	S30A-6111DL	1052594
			Copper cable <sup>2)</sup>	S30A-6111DP	1045653
	7 m	16	Optical fiber <sup>1)</sup>	S30A-7111DL	1052596
			Copper cable <sup>2)</sup>	S30A-7111DP	1045655

<sup>1)</sup> 2 female connectors for SCRJ push-pull plug.

<sup>2)</sup> 2 female connectors for RJ-45 push-pull plug.

## Accessories required for commissioning

Description	Quantity	Scope of delivery	Additional information <sup>1)</sup>							
				S3000 Standard	S3000 Advanced	S3000 Professional	S3000 Expert	S3000 Remote	S3000 PROFINET IO Advanced	S3000 PROFINET IO Professional
Mounting kit	1	-	→ Mounting brackets and plates	●	●	●	●	●	●	●
System plug	1 <sup>2)</sup>	-	→ Plug connectors and cables	●	●	●	●	●	-	-
Power supply male connector (PROFINET IO)	1	-	→ Plug connectors and cables	-	-	-	-	-	●	●
Service cable for configuration and diagnostics	1	-	→ Plug connectors and cables	●	●	●	●	●	-	-
CDS (configuration and diagnostic software)	1	✓	-	●	●	●	●	●	●	●







<sup>1)</sup> You can find the necessary accessories under the specified category at → [www.sick.com](http://www.sick.com).

<sup>2)</sup> For system plugs without a cable, you will also need a connecting cable.

## Recommended accessories

### Mounting systems



#### Mounting brackets and plates

Figure	Description	Packaging unit	Type	Part no.
	Mounting kit for wall mounting (adjustment bracket), steel, galvanized	-	Mounting kit	2018303
	Mounting bracket for direct rear mounting on a wall or machine, no adjustment possible	1 item	Mounting kit 1	2015623
	Mounting bracket for rear mounting on a wall or machine, longitudinal and cross-wise adjustment possible, only in conjunction with mounting kit 1 (2015623)	1 item	Mounting kit 2	2015624
	Mounting bracket for rear or base mounting on a wall or machine, longitudinal and cross-wise adjustment possible, only in conjunction with mounting kit 1 (2015623) and 2 (2015624)	1 item	Mounting kit 3	2015625
	Mounting bracket, heavy-duty version, with protection cover, for floor mounting, adjustable longitudinal and lateral axes via alignment plate, height adjustment possible. Tilt angle ± 5°. Additional mounting brackets are not required. Steel, lacquered (RAL 1021)	1 item	Heavy duty mounting kit	2080350
	Visor for heavy duty mounting kit (2080350), steel, lacquered (RAL 1021)	1 item	Heavy duty visor	2083733

### Connection technology

#### Plug connectors and cables

#### System plug

Figure	Type	Number of wires	Type	Part no.
	Without cable, not suitable with incremental encoders, integrated configuration storage	-	SX0A-A0000B	2023797
	Without cable, suitable with incremental encoders, integrated configuration storage	-	SX0A-A0000D	2023310



### S300 Mini

- [www.sick.com/S300\\_Mini\\_Remote](http://www.sick.com/S300_Mini_Remote)
- [www.sick.com/S300\\_Mini\\_Standard](http://www.sick.com/S300_Mini_Standard)

#### Ordering information

Variant	Protective field range	Number of fields	Type	Part no.
S300 Mini Standard	2 m	3	S32B-2011BA	1050932
	3 m	3	S32B-3011BA	1056430
S300 Mini Remote	2 m	48	S32B-2011EA	1051884
	3 m	48	S32B-3011EA	1056431



### S300

- [www.sick.com/S300\\_Standard](http://www.sick.com/S300_Standard)
- [www.sick.com/S300\\_Advanced](http://www.sick.com/S300_Advanced)
- [www.sick.com/S300\\_Professional](http://www.sick.com/S300_Professional)
- [www.sick.com/S300\\_Expert](http://www.sick.com/S300_Expert)

#### Ordering information

Variant	Protective field range	Number of fields	Type	Part no.
S300 Standard	2 m	3	S30B-2011BA	1026820
	3 m	3	S30B-3011BA	1056427
S300 Advanced	2 m	12	S30B-2011CA	1026821
	3 m	12	S30B-3011CA	1056428
S300 Professional	2 m	24	S30B-2011DA	1026822
	3 m	24	S30B-3011DA	1056429
S300 Expert	2 m	48	S30B-2011GB	1050193
	3 m	48	S30B-3011GB	1057641

## Accessories required for commissioning

Description	Quantity	Scope of delivery	Additional information <sup>1)</sup>	S300 Mini		S300			
				S300 Mini Remote	S300 Mini Standard	S300 Standard	S300 Advanced	S300 Professional	S300 Expert
Mounting kit	1	-	→ Mounting brackets and plates	●	●	●	●	●	●
System plug	1 <sup>2)</sup>	-	→ Plug connectors and cables	-	-	●	●	●	●
Connecting cable	1	-	→ Plug connectors and cables	●	●	-	-	-	-
EFI partner device	1 <sup>3)</sup>	-	-	●	-	-	-	-	-
Service cable for configuration and diagnostics	1	-	→ Plug connectors and cables	●	●	●	●	●	●
CDS (configuration and diagnostic software)	1	✓	-	●	●	●	●	●	●

<sup>1)</sup> You can find the necessary accessories under the specified category at → [www.sick.com](http://www.sick.com).





<sup>2)</sup> For system plugs without a cable, you will also need a connecting cable.

<sup>3)</sup> Only applicable to S300 Mini Remote: Because the S300 Mini Remote has no local OSSDs on the device, it has to be connected to an EFI partner device (e.g. Flexi Soft).

## Recommended accessories

## Mounting systems



## Mounting brackets and plates

Figure	Description	Packing unit	Type	Part no.
	Mounting bracket for rear mounting on a wall or machine	1 item	Mounting kit 1a	2034324
	Mounting bracket for rear mounting on a wall or machine with protection of optics cover	1 item	Mounting kit 1b	2034325
	Mounting bracket, cross-wise adjustment possible, only in conjunction with mounting kit 1a (2034324) or 1b (2034325)	1 item	Mounting kit 2	2039302
	Holding plate, longitudinal adjustment possible, only in conjunction with mounting kit 2 (2039302)	1 item	Mounting kit 3	2039303

## Connection technology

## Plug connectors and cables

## System plug

Figure	Type	Packing unit	Type	Part no.
	Without cable, not suitable with incremental encoders, integrated configuration storage	1 item	SX0B-A0000G	2032807
	Without cable, suitable with incremental encoders, integrated configuration storage	1 item	SX0B-A0000J	2032856





TiM-S

→ [www.sick.com/tim-s](http://www.sick.com/tim-s)

Ordering information

Variant	Protective field range	Number of fields	Type	Part no.
TiM361S	4 m	48	TiM361S-2134101	1090608
TiM781S	5 m	48	TiM781S-2174104	1096363

Recommended accessories

Mounting systems

Mounting brackets and plates





Figure	Description	Packing unit	Type	Part no.
	Mounting kit	1 item	Mounting kit	2086761

Accessories required for commissioning

Description	Quantity	Scope of delivery	More information
Mounting kit	1	-	→ Mounting brackets and plates
Connecting cable	1	-	→ <a href="http://www.sick.com/tim-s">www.sick.com/tim-s</a>
Connection cable for configuration and diagnostics	1	-	→ <a href="http://www.sick.com/tim-s">www.sick.com/tim-s</a>
SOPAS Engineering Tool	1	-	→ <a href="http://www.sick.com/sopas">www.sick.com/sopas</a>
Operating instructions	1	-	→ <a href="http://www.sick.com/tim-s">www.sick.com/tim-s</a>

## Additional accessories

## Test and monitoring tools

Figure	Description	Working range	Type	Part no.
 Illustration may differ	Alignment aid for detecting the infrared light of SICK sensors.	-	Alignment aid	2101720
	If a machine stops unexpectedly due to the triggering of a protective device (e.g., a safety laser scanner), the SICK EventCam helps find the cause. With the help of the event-controlled camera, you can now receive additional visual information about the rejected material.	0.4 m ... 0.6 m	EVC625-CCOVAL5L	1102028
		0.8 m ... 6 m	EVC625-CCOXAL5L	1093139
	50 mm diameter, 500 mm length	-	Test rod 50 mm	2095105
	70 mm diameter, 500 mm length	-	Test rod 70 mm	2095139
	Test rod holder for test rods with 50 mm and 70 mm diameter	-	Test rod holder	4096204

## Other mounting accessories

## Mounting tools

Figure	Description	Type	Part no.
	For loosening M12 plug connectors at the system plug, and tightening them with a defined torque (0.4 Nm), shank length: 100 mm, hexagonal recess: 4 mm, knurl diameter: 15 mm	Torque screwdriver with attachment for M12 plug connectors	2081618



outdoorScan3

→ [www.sick.com/outdoorScan3](http://www.sick.com/outdoorScan3)

Ordering information

Variant	Integration in the control	Protective field range	Number of fields	Number of monitoring cases	Type	Part no.
outdoorScan3 Core I/O	Local inputs and outputs (I/O)	4 m	8	2	MICS3-AAU-Z40AZ1P01	1094452
outdoorScan3 Pro – EtherNet/IP™	CIP Safety™ over EtherNet/IP™	4 m	128	128	MICS3-CBUZ-40IZ1P01	1094472

Accessories required for commissioning

Description	Quantity	Scope of delivery	More information	outdoorScan3	outdoorScan3
				Core I/O	EtherNet/IP
Mounting kit	1	–	→ Mounting brackets and plates	●	●
I/O connecting cable	1	–	→ <a href="http://www.sick.com/outdoorScan3">www.sick.com/outdoorScan3</a>	●	–
Connecting cable for EtherNet/IP™	1	–	→ <a href="http://www.sick.com/outdoorScan3">www.sick.com/outdoorScan3</a>	–	●
M12-RJ45 connection cable for EtherNet/IP™	1	–	→ <a href="http://www.sick.com/outdoorScan3">www.sick.com/outdoorScan3</a>	–	●
Connection cable for configuration and diagnostics	1	–	→ <a href="http://www.sick.com/outdoorScan3">www.sick.com/outdoorScan3</a>	●	–
Safety Designer (configuration and diagnostic software)	1	–	→ <a href="http://www.sick.com/safety_designer">www.sick.com/safety_designer</a>	●	●
Operating instructions	1	–	→ <a href="http://www.sick.com/outdoorScan3">www.sick.com/outdoorScan3</a>	●	●





Recommended software

Software	Description	More information
AGV Dynamic Weather Assist	Software function block for the Safety Designer. Using the function block, the safety laser scanner automatically switches its protective fields depending on the weather, thereby enabling continuous operation of the AGV.	→ <a href="http://www.sick.com/agv_dynamic_weather_assist">www.sick.com/agv_dynamic_weather_assist</a>
Safety Laser Scanner Visualization	Software solution for Windows-based SCADA systems (e.g., WinCC) and Windows PCs for real-time visualization and analysis of diagnostic and device information for all safety laser scanners connected via the network.	→ <a href="http://www.sick.com/safety_laser_scanner_visualization">www.sick.com/safety_laser_scanner_visualization</a>
Monitoring App outdoorScan3	The Monitoring app is a browser application that enables sensor and machine data to be visualized in a dashboard, and error states to be diagnosed and monitored.	→ <a href="http://www.sick.com/1614150">www.sick.com/1614150</a>

## Accessories

### Mounting systems

#### Mounting brackets and plates

Figure	Description	Packing unit	Type	Part no.
	Mounting bracket	1 item	Mounting kit 1a	2073851
	Mounting bracket with optics cover protection	1 item	Mounting kit 1b	2074242
	Alignment bracket, alignment with cross-wise axis and depth axis possible, distance between mounting surface and device: 22.3 mm, only in conjunction with mounting kit 1a (2073851) or 1b (2074242)	1 item	Mounting kit 2a	2073852
	Alignment bracket, alignment with cross-wise axis and depth axis possible, distance between mounting surface and device: 52.3 mm, only in conjunction with mounting kit 1a (2073851) or 1b (2074242)	1 item	Mounting kit 2b	2074184
	Alignment bracket with protection for the optics cover, alignment with cross-wise axis and depth axis possible	1 item	Mounting kit 3	2103049

#### Device protection (mechanical)

#### Protective housing and pipes

	Description	Type	Part no.
	Weather protection hood, only in conjunction with mounting kit 3 (2103049)	Weather protection hood	2103050
	Splash guard, only in conjunction with mounting kit 3 (2103049)	Splash guard	2123205





# WORKING WITH SICK IN A DIGITAL WORLD

Making your digital business environment comfortable

## Find a suitable solution in next to no time

Often we know best what we need – but not necessarily where to find it right away. SICK will support you with its in-depth expertise.

- Online product catalog – our digital flagship  
→ [www.sick.com/products](http://www.sick.com/products)
- Application Solver – the right sensor for selected applications → [www.sick.com/applicationBased](http://www.sick.com/applicationBased)
- Online configurators and selectors – exactly the right sensor for your needs

## My SICK is your personal self-service portal

My SICK is your personal self-service portal with lots of helpful information and your own individual access to the web shop. Take advantage of the wide variety of exclusive advantages on offer:

### Your benefits

- Open around the clock
- Clear product information
- Company-specific price conditions
- Convenience during the ordering process
- Document overview
- Availability and delivery times

### Register now:

→ [www.sick.com/myBenefits](http://www.sick.com/myBenefits)



## Get ahead with digital knowledge transfer and digital services

- Digital Customer Trainings → [www.sick.com/c/g300887](http://www.sick.com/c/g300887)
- Digital Service Catalog → [cloud.sick.com](http://cloud.sick.com)
- SICK AppPool → [apppool.cloud.sick.com](http://apppool.cloud.sick.com)

## SICK AT A GLANCE

SICK is a leading manufacturer of intelligent sensors and sensor solutions for industrial applications. With more than 10,400 employees and over 50 subsidiaries and equity investments as well as numerous agencies worldwide, SICK is always close to its customers. A unique range of products and services creates the perfect basis for controlling processes securely and efficiently, protecting individuals from accidents, and preventing damage to the environment.

SICK has extensive experience in various industries and understands their processes and requirements. With intelligent sensors, SICK delivers exactly what the customers need. In application centers in Europe, Asia, and North America, system solutions are tested and optimized in accordance with customer specifications. All this makes SICK a reliable supplier and development partner.

Comprehensive services round out the offering: SICK LifeTime Services provide support throughout the machine life cycle and ensure safety and productivity.

**That is “Sensor Intelligence.”**

### **Worldwide presence:**

Australia, Austria, Belgium, Brazil, Canada, Chile, China, Czech Republic, Denmark, Finland, France, Germany, Great Britain, Hungary, Hong Kong, India, Israel, Italy, Japan, Malaysia, Mexico, Netherlands, New Zealand, Norway, Poland, Romania, Russia, Singapore, Slovakia, Slovenia, South Africa, South Korea, Spain, Sweden, Switzerland, Taiwan, Thailand, Turkey, United Arab Emirates, USA, Vietnam.

Detailed addresses and further locations → [www.sick.com](http://www.sick.com)