

OD1000

Displacement measurement sensor

SICK
Sensor Intelligence.



Product described

OD1000

Manufacturer

SICK AG
Erwin-Sick-Str. 1
79183 Waldkirch
Germany

Legal information

This work is protected by copyright. Any rights derived from the copyright shall be reserved for SICK AG. Reproduction of this document or parts of this document is only permissible within the limits of the legal determination of Copyright Law. Any modification, abridgment or translation of this document is prohibited without the express written permission of SICK AG.

The trademarks stated in this document are the property of their respective owner.

© SICK AG. All rights reserved.

Original document

This document is an original document of SICK AG.

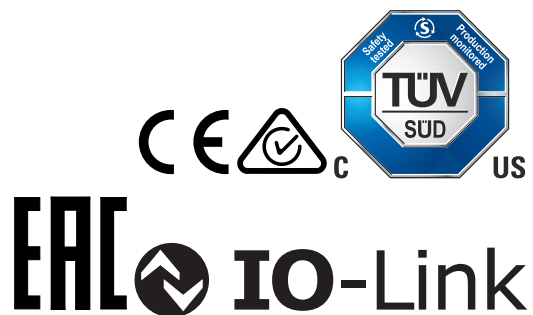

Contents

1	About this document.....	6
1.1	Information on the operating instructions.....	6
1.2	Explanation of symbols.....	6
1.3	Further information.....	7
1.4	SICK service.....	7
2	Safety information.....	8
2.1	Intended use.....	8
2.2	Improper use.....	8
2.3	Internet protocol (IP) technology.....	8
2.4	Limitation of liability.....	8
2.5	Modifications and conversions.....	9
2.6	Requirements for skilled persons and operating personnel.....	9
2.7	Operational safety and particular hazards.....	10
2.8	Warning signs on the device.....	10
3	Product description.....	12
3.1	Product ID.....	12
3.2	Scope of delivery.....	13
3.3	Product characteristics.....	13
3.4	Setup and dimensions.....	14
4	Transport and storage.....	15
4.1	Transport.....	15
4.2	Unpacking.....	15
4.3	Transport inspection.....	15
4.4	Storage.....	15
5	Mounting.....	17
5.1	Mounting instructions.....	17
5.2	Mounting device.....	17
6	Electrical installation.....	18
6.1	Safety.....	18
6.2	Wiring instructions.....	18
6.3	Connecting the device electrically.....	20
7	Operation.....	22
7.1	General notes.....	22
7.2	Control elements and status indicators.....	22
7.2.1	Indicator lights.....	22
7.2.2	Operating buttons.....	23
7.3	Operating concept.....	23
8	Operation via display.....	24

8.1	Menu structure and parameter description.....	24
8.1.1	Main display level and main menu.....	24
8.1.2	Measurement menu group.....	25
8.1.3	I/O interface menu group: Q1 output.....	26
8.1.4	I/O interface menu group: Q2/Qa output, In1 input.....	27
8.1.5	Device menu group.....	28
8.1.6	Communication menu group.....	28
8.1.7	Info menu group.....	28
8.2	Main display level.....	28
8.3	Measurement.....	29
8.3.1	Application settings.....	29
8.3.2	Default settings.....	34
8.4	I/O interface.....	39
8.4.1	Q1 output.....	39
8.4.2	Q ₂ / Q _a output.....	46
8.4.3	In1 input.....	48
8.5	Device.....	53
8.5.1	User level.....	53
8.5.2	Reset.....	53
8.5.3	Saving customer settings.....	54
8.5.4	Language.....	54
8.5.5	Display settings.....	54
8.5.6	Measurement laser.....	55
8.6	Communication.....	55
8.7	Info.....	55
8.7.1	Firmware verification.....	55
8.7.2	Serial number.....	56
8.7.3	Sensor operating hours.....	56
8.7.4	Laser operating hours.....	56
8.7.5	Sensor status.....	56
8.7.6	Part number.....	56
9	Operation via IO-Link.....	58
9.1	Process data.....	58
9.2	Device data.....	58
10	Operation via SOPAS ET.....	59
11	Maintenance.....	61
11.1	Cleaning.....	61
11.2	Maintenance plan.....	61
12	Troubleshooting.....	62
12.1	General faults, warnings, and errors.....	62
12.2	Detecting and displaying errors.....	62
12.3	Information for service cases.....	63

12.4	Returns.....	63
12.5	Repairs.....	64
12.6	Disposal.....	64
13	Technical data.....	65
13.1	Mechanics/electronics.....	65
13.2	Performance.....	65
13.3	Interfaces.....	66
13.4	Ambient data.....	67
14	Accessories.....	68
15	Annex.....	69
15.1	EU declaration of conformity / Certificates.....	69
15.2	Licenses.....	69

1 About this document

1.1 Information on the operating instructions

These operating instructions provide important information on how to use devices from SICK AG.

Prerequisites for safe work are:

- Compliance with all safety notes and handling instructions supplied.
- Compliance with local work safety regulations and general safety regulations for device applications

The operating instructions are intended to be used by qualified personnel and electrical specialists.



NOTE

Read these operating instructions carefully to familiarize yourself with the device and its functions before commencing any work.

The operating instructions are an integral part of the product. Store the instructions in the immediate vicinity of the device so they remain accessible to staff at all times. Should the device be passed on to a third party, these operating instructions should be handed over with it.

These operating instructions do not provide information on operating the machine or system in which the device is integrated. For information about this, refer to the operating instructions of the specific machine.

1.2 Explanation of symbols

Warnings and important information in this document are labeled with symbols. Signal words introduce the instructions and indicate the extent of the hazard. To avoid accidents, damage, and personal injury, always comply with the instructions and act carefully.



DANGER

... indicates a situation of imminent danger, which will lead to a fatality or serious injuries if not prevented.



WARNING

... indicates a potentially dangerous situation, which may lead to a fatality or serious injuries if not prevented.



CAUTION

... indicates a potentially dangerous situation, which may lead to minor/slight injuries if not prevented.



NOTICE

... indicates a potentially harmful situation, which may lead to material damage if not prevented.



NOTE

... highlights useful tips and recommendations as well as information for efficient and trouble-free operation.

1.3 Further information

**NOTE**

Further documentation for the device can be found on the online product page at:

- www.sick.com/OD1000

There, additional information has been provided depending on the product, such as:

- Model-specific online data sheets for device types, containing technical data, dimensional drawing, and specification diagrams
 - EU declarations of conformity for the product family
 - Dimensional drawings and 3D CAD dimension models of the device types in various electronic formats
 - Other publications related to the devices described here
 - Publications dealing with accessories
-

1.4 SICK service

If you require any technical information, our SICK Service will be happy to help. To find your agency, see the final page of this document.

**NOTE**

Before calling, make a note of all type label data such as type code, serial number, etc., to ensure faster processing.

2 Safety information

2.1 Intended use

The displacement measurement sensor is an opto-electronic measuring device and is used for optical, non-contact distance measurement of objects.

The required optical properties of the object that will be detected are specified in the technical data section of this document.

SICK AG assumes no liability for losses or damage arising from the use of the product, either directly or indirectly. This applies in particular to use of the product that does not conform to its intended purpose and is not described in this documentation.

2.2 Improper use

Any use outside of the stated areas, in particular use outside of the technical specifications and the requirements for intended use, will be deemed to be incorrect use.

- The device does not constitute a safety component in accordance with the respective applicable safety standards for machines.
- The device must not be used in explosion-hazardous areas, in corrosive environments or under extreme environmental conditions.
- Any use of accessories not specifically approved by SICK AG is at your own risk.



WARNING

Danger due to improper use!

Any improper use can result in dangerous situations.

Therefore, observe the following information:

- Product should be used only in accordance with its intended use.
 - All information in these operating instructions must be strictly observed.
 - Shut down the product immediately in case of damage.
-

2.3 Internet protocol (IP) technology



NOTE

SICK uses standard IP technology in its products. The emphasis is placed on availability of products and services.

SICK always assumes the following prerequisites:

- The customer ensures the integrity and confidentiality of the data and rights affected by its own use of the aforementioned products.
 - In all cases, the customer implements the appropriate security measures, such as network separation, firewalls, virus protection, and patch management.
-

2.4 Limitation of liability

Relevant standards and regulations, the latest technological developments, and our many years of knowledge and experience have all been taken into account when compiling the data and information contained in these operating instructions. The manufacturer accepts no liability for damage caused by:

- Non-adherence to the product documentation (e.g., operating instructions)
- Incorrect use
- Use of untrained staff
- Unauthorized conversions or repair

- Technical modifications
- Use of unauthorized spare parts, consumables, and accessories

With special variants, where optional extras have been ordered, or owing to the latest technical changes, the actual scope of delivery may vary from the features and illustrations shown here.

2.5 Modifications and conversions



NOTICE

Modifications and conversions to the device may result in unforeseeable dangers.

Interrupting or modifying the device or SICK software will invalidate any warranty claims against SICK AG. This applies in particular to opening the housing, even as part of mounting and electrical installation.

2.6 Requirements for skilled persons and operating personnel



WARNING

Risk of injury due to insufficient training.

Improper handling of the device may result in considerable personal injury and material damage.

- All work must only ever be carried out by the stipulated persons.

This product documentation refers to the following qualification requirements for the various activities associated with the device:

- **Instructed personnel** have been briefed by the operator about the tasks assigned to them and about potential dangers arising from improper action.
- **Skilled personnel** have the specialist training, skills, and experience, as well as knowledge of the relevant regulations, to be able to perform tasks delegated to them and to detect and avoid any potential dangers independently.
- **Electricians** have the specialist training, skills, and experience, as well as knowledge of the relevant standards and provisions, to be able to carry out work on electrical systems and to detect and avoid any potential dangers independently. The electrician must comply with the provisions of the locally applicable work safety regulation.

The following qualifications are required for various activities:

Table 1: Activities and technical requirements

Activities	Qualification
Mounting, maintenance	<ul style="list-style-type: none"> ■ Basic practical technical training ■ Knowledge of the current safety regulations in the workplace
Electrical installation, device replacement	<ul style="list-style-type: none"> ■ Practical electrical training ■ Knowledge of current electrical safety regulations ■ Knowledge of the operation and control of the devices in their particular application
Commissioning, configuration	<ul style="list-style-type: none"> ■ Basic knowledge of the Windows™ operating system in use ■ Basic knowledge of the design and setup of the described connections and interfaces ■ Basic knowledge of data transmission

Activities	Qualification
Operation of the device for the particular application	<ul style="list-style-type: none"> ■ Knowledge of the operation and control of the devices in their particular application ■ Knowledge of the software and hardware environment for the particular application

2.7 Operational safety and particular hazards

Please observe the safety notes and the warnings listed here and in other chapters of this product documentation to reduce the possibility of risks to health and avoid dangerous situations.



CAUTION

Optical radiation: Laser class 1

The accessible radiation does not pose a danger when viewed directly for up to 100 seconds. It may pose a danger to the eyes and skin in the event of incorrect use.

- Do not open the housing. Opening the housing may increase the level of risk.
- Current national regulations regarding laser protection must be observed.

Caution – Use of controls or adjustments or performance of procedures other than those specified herein may result in hazardous radiation exposure.



WARNING

Electrical voltage!

Electrical voltage can cause severe injury or death.

- Work on electrical systems must only be performed by qualified electricians.
- The power supply must be disconnected when attaching and detaching electrical connections.
- The product must only be connected to a voltage supply as set out in the requirements in the operating instructions.
- National and regional regulations must be complied with.
- Safety requirements relating to work on electrical systems must be complied with.



WARNING

Risk of injury and damage caused by potential equalization currents!

Improper grounding can lead to dangerous equipotential bonding currents, which may in turn lead to dangerous voltages on metallic surfaces, such as the housing. Electrical voltage can cause severe injury or death.

- Work on electrical systems must only be performed by qualified electricians.
- Follow the notes in the operating instructions.
- Install the grounding for the product and the system in accordance with national and regional regulations.

2.8 Warning signs on the device

A visible red laser is installed in the device. The laser corresponds to laser class 1. The housing is labeled with a warning sign.



Figure 1: Warning sign on the device: LASER RADIATION: laser class 1

3 Product description

3.1 Product ID

Type label

The following information can be read off the device from the type label:

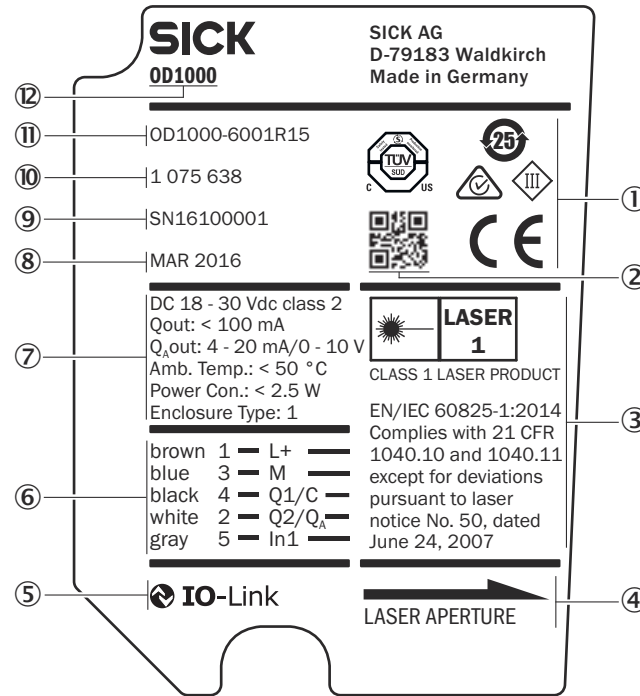

Figure 2: OD1000 type label

- ① Approval marks and test symbols
- ② 2D code with part number and serial number
- ③ Laser information
- ④ Laser radiation direction
- ⑤ IO-Link symbol
- ⑥ Pin assignment
- ⑦ Electrical data and environmental data
- ⑧ Month and year of manufacture
- ⑨ Serial number
- ⑩ Part number
- ⑪ Type code
- ⑫ Device family

Device display

The following information can be called up using the info menu on the device display:

- Firmware verification
- Serial number
- Sensor operating hours
- Laser operating hours
- Sensor status (error history)
- Part number

3.2 Scope of delivery

Included in scope of delivery:

- Distance sensor
- Protective caps for connections (on the device)
- Printed Safety Notes, multilingual (brief information and general safety notes)

Accessories

Accessories such as brackets and connecting cables is only delivered if the accessories have been ordered separately, see "Accessories", page 68.

3.3 Product characteristics

The displacement measurement sensor uses the triangulation principle for distance measurement. The triangulation principle makes it possible to measure the distance between the displacement measurement sensor and an object.

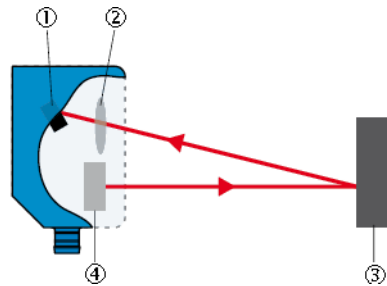

Figure 3: Triangulation principle

- ① Receiver
- ② Lens
- ③ Object
- ④ Laser

A point of light is projected onto the measuring object. The light reflected is captured by a light-sensitive receiver at a specific angle. Based on the angle between the send and receive direction, the position of the object is triangulated (lat. Triangulum: triangle).

The distance determined is transmitted via the IO-Link interface. The analog signal output converts the distance value into an output signal proportional to the distance (switchable: mA/V).

Digital outputs can be used to monitor when configured switching threshold/distance values have been reached. The "Distance to the object", "Window", and "ObSB" switching functions are supported.

Measured distance values can be visualized and parameter settings can be made using the graphical OLED display. Alternatively, the displacement measurement sensor can be configured via the IO-Link interface in conjunction with an IO-Link master. The SOPAS user interface can be used for configuration as well. This process also takes place via the IO-Link interface in conjunction with an IO-Link master. For additional information visit:

www.sick.com/SOPAS_ET

3.4 Setup and dimensions

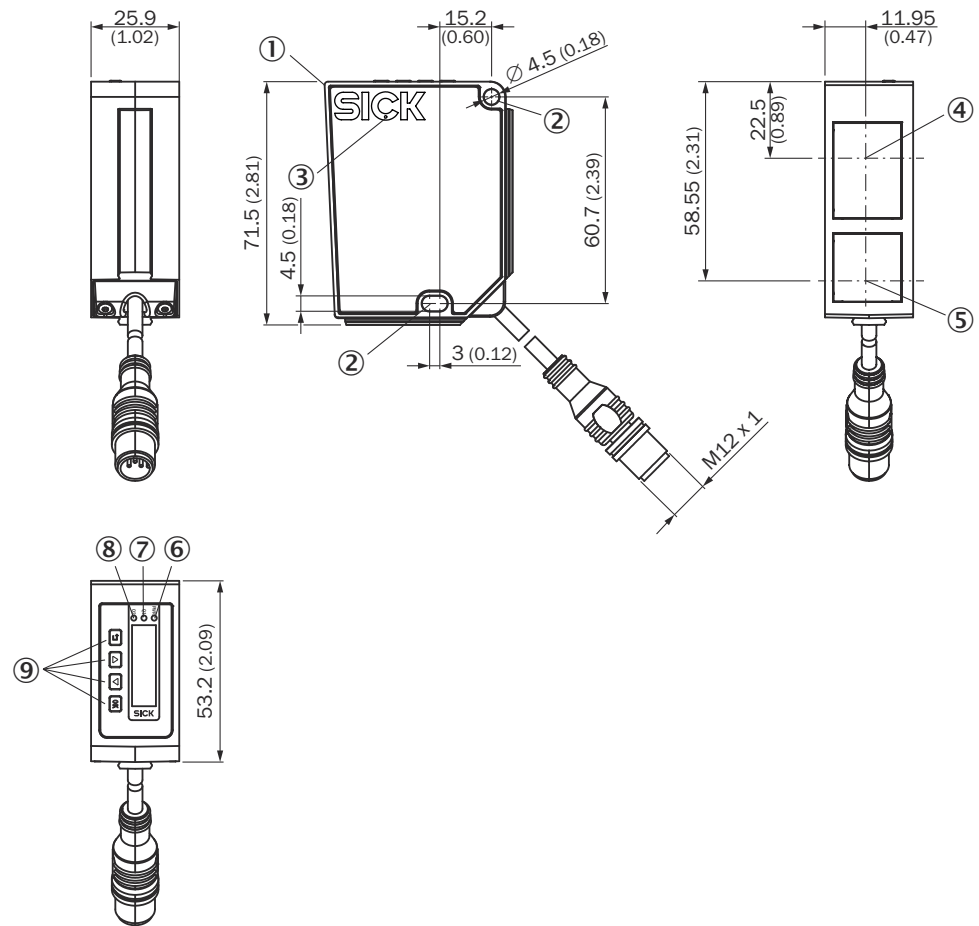

Figure 4: structure and device dimensions, unit: mm (inch), decimal separator: period

- ① Device zero point (distance = 0 mm)
- ② Fixing holes (for M4)
- ③ Ventilation opening – do not cover!
- ④ Center of optical axis, receiver
- ⑤ Center of optical axis, sender
- ⑥ Male connector, M12, 5-pin, A-coded
- ⑦ PWR LED green
- ⑧ Q1 LED, yellow
- ⑨ Q2 LED, yellow
- ⑩ Display operating elements

4 Transport and storage

4.1 Transport

For your own safety, please read and observe the following notes:



NOTICE

Damage to the product due to improper transport.

- The device must be packaged for transport with protection against shock and damp.
- Recommendation: Use the original packaging as it provides the best protection.
- Transport should be performed by trained specialist staff only.
- The utmost care and attention is required at all times during unloading and transportation on company premises.
- Note the symbols on the packaging.
- Do not remove packaging until immediately before you start mounting.

4.2 Unpacking

- To protect the device against condensation, allow it to equilibrate with the ambient temperature before unpacking if necessary.
- Handle the device with care and protect it from mechanical damage.
- To avoid ingress of dust and water, only remove the protective caps of the electrical connections just before attaching the connecting cable.

4.3 Transport inspection

Immediately upon receipt in Goods-in, check the delivery for completeness and for any damage that may have occurred in transit. In the case of transit damage that is visible externally, proceed as follows:

- Do not accept the delivery or only do so conditionally.
- Note the scope of damage on the transport documents or on the transport company's delivery note.
- File a complaint.



NOTE

Complaints regarding defects should be filed as soon as these are detected. Damage claims are only valid before the applicable complaint deadlines.

4.4 Storage

Store the device under the following conditions:

- Recommendation: Use the original packaging.
- Electrical connections are provided with a protective cap (as in the delivery condition).
- Do not store outdoors.
- Store in a dry area that is protected from dust.
- So that any residual damp can evaporate, do not package in airtight containers.
- Do not expose to any aggressive substances.
- Protect from sunlight.
- Avoid mechanical shocks.

- Storage temperature: see ["Technical data", page 65](#).
- For storage periods of longer than 3 months, check the general condition of all components and packaging on a regular basis.

5 Mounting

5.1 Mounting instructions

- Observe the technical data.
- Protect the sensor from direct sunlight.
- To prevent condensation, avoid exposing the device to rapid changes in temperature.
- The mounting site has to be designed for the weight of the device.
- To avoid inaccurate measurements when installing multiple devices: Make sure that the laser light spot of one device is not in the visible range of another device.
- Take into account the device warm-up time of 30 minutes. During the device warm-up phase, the measured values are subject to an increased variance (temperature drift).

5.2 Mounting device

1. Mount the device using the designated fixing holes, see ["Setup and dimensions", page 14](#).
2. Make the electrical connection. Attach and tighten a voltage-free cable, see ["Connecting the device electrically", page 20](#).
3. Switch on the supply voltage.
- ✓ The green operating LED lights up.
The device needs around 10 seconds of initialization time before it is ready for operation.
4. Align the light spot so that the desired object is measured.

6 Electrical installation

6.1 Safety



WARNING**Personal injury due to improper supply voltage!**

- Only operate the device using safety extra-low voltage and safe electrical insulation as per protection class III.
-

**NOTICE****Equipment damage or unpredictable operation due to working with live parts.**

Working with live parts may result in unpredictable operation.

- Only carry out wiring work when the power is off.
 - Only connect and disconnect electrical connections when the power is off.
-

6.2 Wiring instructions

**NOTE**

Pre-assembled cables can be found online at:

- www.sick.com/OD1000
-

**NOTICE****Faults during operation and device or system defects!**

Incorrect wiring may result in operational faults and defects.

- Follow the wiring notes precisely.
-

The electrical connection of the device is configured as an M12 round connector.

The protection class stated in the technical data is achieved only with a screwed plug connector or protective cap.

Shielding requirements

- To ensure a fault-free data transmission, an effective and comprehensive shielding solution must be implemented.
- Apply a cable shield at each end, i.e. in the control cabinet and at the device. The cable shield of the pre-assembled cables is connected to the knurled nut and thus also to a large area of the device housing.
- The cable shield in the control cabinet must be connected to a large area of the signal ground.
- Take appropriate measures to prevent equipotential bonding currents flowing through the cable shield.
- During installation, pay attention to the different cable groups. The cables are grouped into the following four groups according to their sensitivity to interference or radiated emissions:
 - Group 1: cables very sensitive to interference, such as analog measuring cables
 - Group 2: cables sensitive to interference, such as device cables, communication signals, bus signals

- Group 3: cables that are a source of interference, such as control cables for inductive loads and motor brakes
- Group 4: cables that are a powerful source of interference, such as output cables from frequency inverters, welding system power supplies, power cables
- ▶ Cables in groups 1, 2 and 3, 4 must be crossed at right angles (see figure 5).
- ▶ Route the cables in groups 1, 2 and 3, 4 in different cable channels or use metallic separators (see figure 6 and see figure 7). This applies particularly if cables of devices with a high level of radiated emission, such as frequency converters, are laid parallel to device cables.

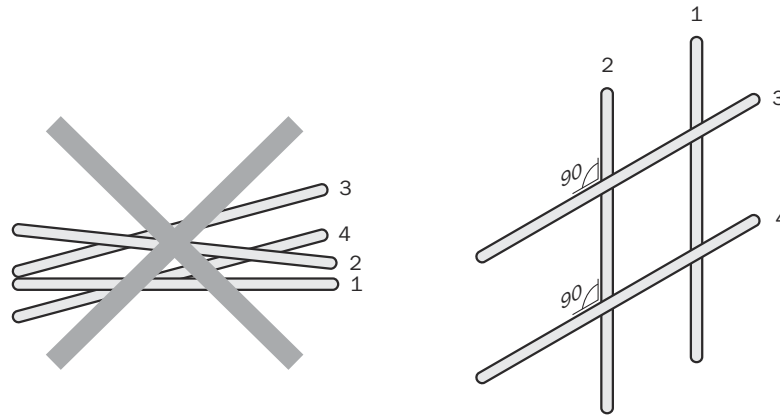

Figure 5: Cross cables at right angles

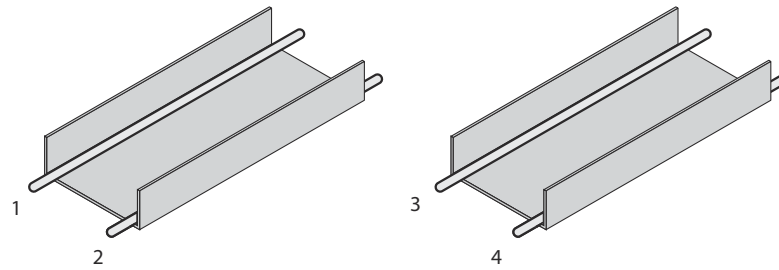

Figure 6: Ideal laying - Place cables in different cable channels

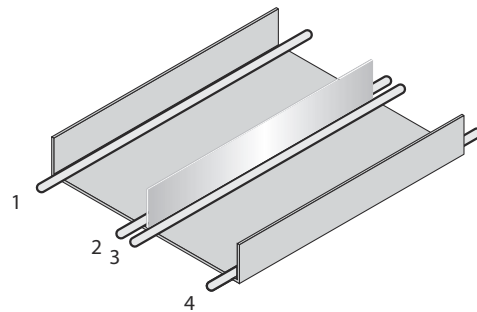

Figure 7: Alternative laying - Separate cables with metallic separators

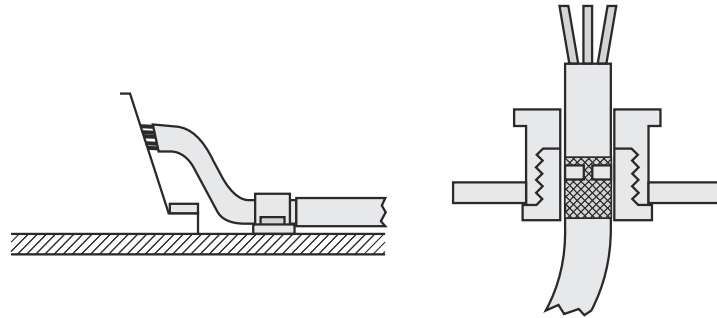

Figure 8: Shield connection in plastic housings



NOTE

Use an appropriate earthing method to prevent equipotential bonding currents flowing through the cable shield. If necessary, ground currents on the EtherNet/IP cabling can be prevented by using an EtherNet/IP adapter (part no. 2044264).

6.3 Connecting the device electrically



NOTE

The connection diagram, and information on inputs and outputs, can be found on the side plate on the device.



NOTICE

All electrical circuits must be connected to the device with safety extra-low voltage (SELV or PELV).

1. Ensure that the voltage supply is not connected.
2. Connect the device according to the connection diagram.
3. Observe the wiring instructions, see "[Wiring instructions](#)", page 18.

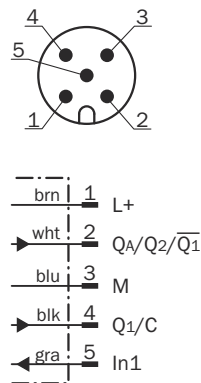

Figure 9: Connection diagram, 5-pin male connector

Table 2: Legend for connection diagram

Contact	Identification	Wire color	Description
1	L+	Brown	Supply voltage: +18 ... +30 V DC
2	$Q_A/Q_2/\overline{Q_1}$	White	Output 2: analog output / digital output 2 (push-pull stage) / not Q_1
3	M	Blue	Supply voltage: 0 V

Contact	Identification	Wire color	Description
4	Q ₁ /C	Black	Output 1: digital output 1 (push-pull stage) / IO-Link
5	In1	Gray	Input 1

7 Operation

7.1 General notes

If the device is not able to perform a measurement even though the measuring object is within the specified measuring range, check the alignment of the device and optimize it if necessary. In general, adjusting the measuring rate can increase the measuring ability for very dark objects, for example.

For a successful teach-in operation, the device must be able to measure. The distance to the teach object must not change during the teach operation. The object must be in the measuring range. The distance values taught in for the distance near to the sensor and the distance far from the sensor must not be exactly the same during a switching window or the analog scaling.

To prevent EMC interference, observe the wiring instructions. If an environment is disrupted by EMC interference, data output via IO-Link is recommended. If the measured values need to be output via the analog output in an application with this kind of environment, use an analog current output. The analog current output is significantly less susceptible to EMC interference than a voltage output.

7.2 Control elements and status indicators

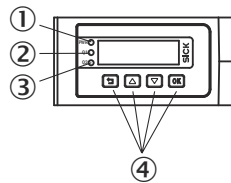

7.2.1 Indicator lights





- ① Status-LED PWR (grün)
- ② Status-LED Q1 (orange)
- ③ Status-LED Q2 (orange)
- ④ Bedientasten





Table 3: Meaning of the indicator lights

Display	Status	Meaning
PWR status indicator	●	Voltage supply available, device ready for use
	○	Voltage supply not available
	●	Voltage supply available, device ready for use, connection to an IO-Link master available
Output display Q ₁	●	Digital output active
	○	Digital output not active
Output display Q ₂	●	Digital output active or measured value within the scaling range for the analog output
	○	Digital output not active or measured value outside the scaling range for the analog output

Display	Status	Meaning
Output displays Q ₁	 Simultaneous	Teach-in operation is carried out
	 5 seconds in alternation	Teach-in operation has failed
	 Permanently in alternation	There is a fault



-  Does not light up
-  Flashing
-  Permanently on

7.2.2 Operating buttons

Pushbutton	Function	Description
	Open menu/ confirm	Opens the menu, confirms entries, or switches to the next menu level of a selected element. Moves the cursor to the right when entering numbers.
	Cancel	Switches to the previous menu level. Moves the cursor to the left when entering numbers.
	Navigate	Switches between multiple screens on one menu level. Increases the value when entering numbers.
	Navigate	Switches between multiple screens on one menu level. Reduces the value when entering numbers.

Activating and deactivating the operating button lock

To prevent accidental operation, lock and unlock the operating buttons using a shortcut:

- ▶ Press and hold the  and  pushbuttons simultaneously for > 3 seconds.
- ✓ When the pushbutton lock is activated, the  padlock symbol appears in the display. When the pushbutton lock is deactivated, the padlock symbol is not displayed.



NOTE

The operating button lock can also be activated and deactivated via SOPAS ET or IO-Link.

7.3 Operating concept

The device can be operated using the following methods:

- Display and operating buttons on the device, [see "Operation via display", page 24.](#)
- SOPAS ET user interface (computer), [see "Operation via SOPAS ET", page 59.](#)
- IO-Link, [see "Operation via IO-Link", page 58.](#)

8 Operation via display



NOTE

Only certain functions are available depending on the user level set (see ["User level"](#), page 53):

- **Easy:** frequently required functions (factory setting)
- **Advanced:** all available functions

8.1 Menu structure and parameter description

8.1.1 Main display level and main menu

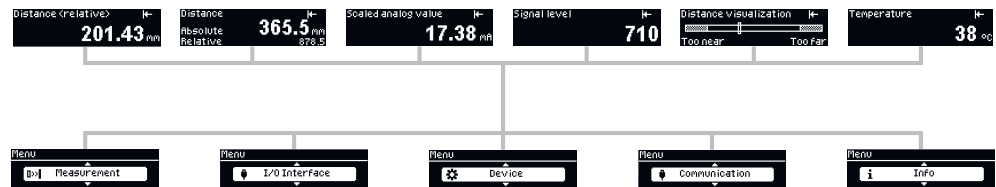

8.1.2 Measurement menu group

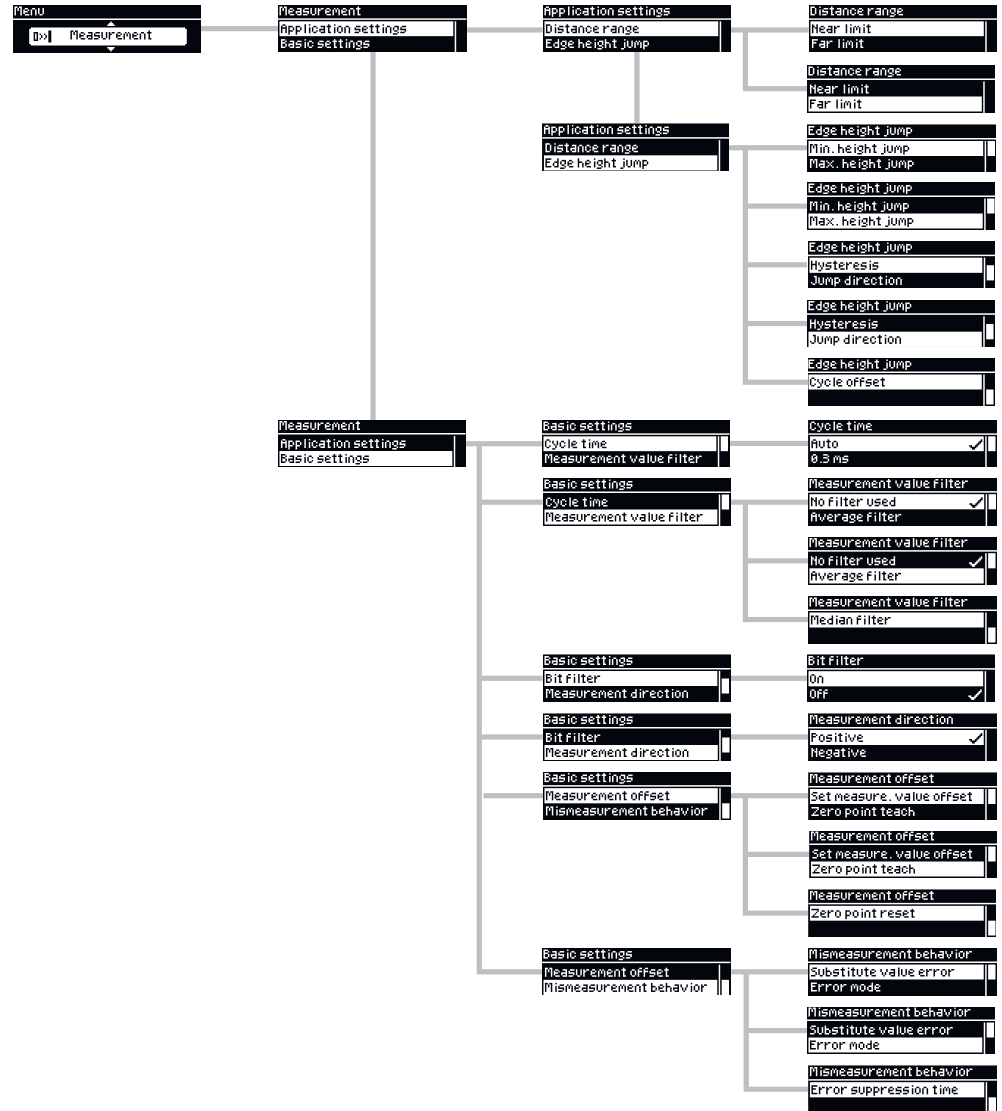

8.1.3 I/O interface menu group: Q1 output

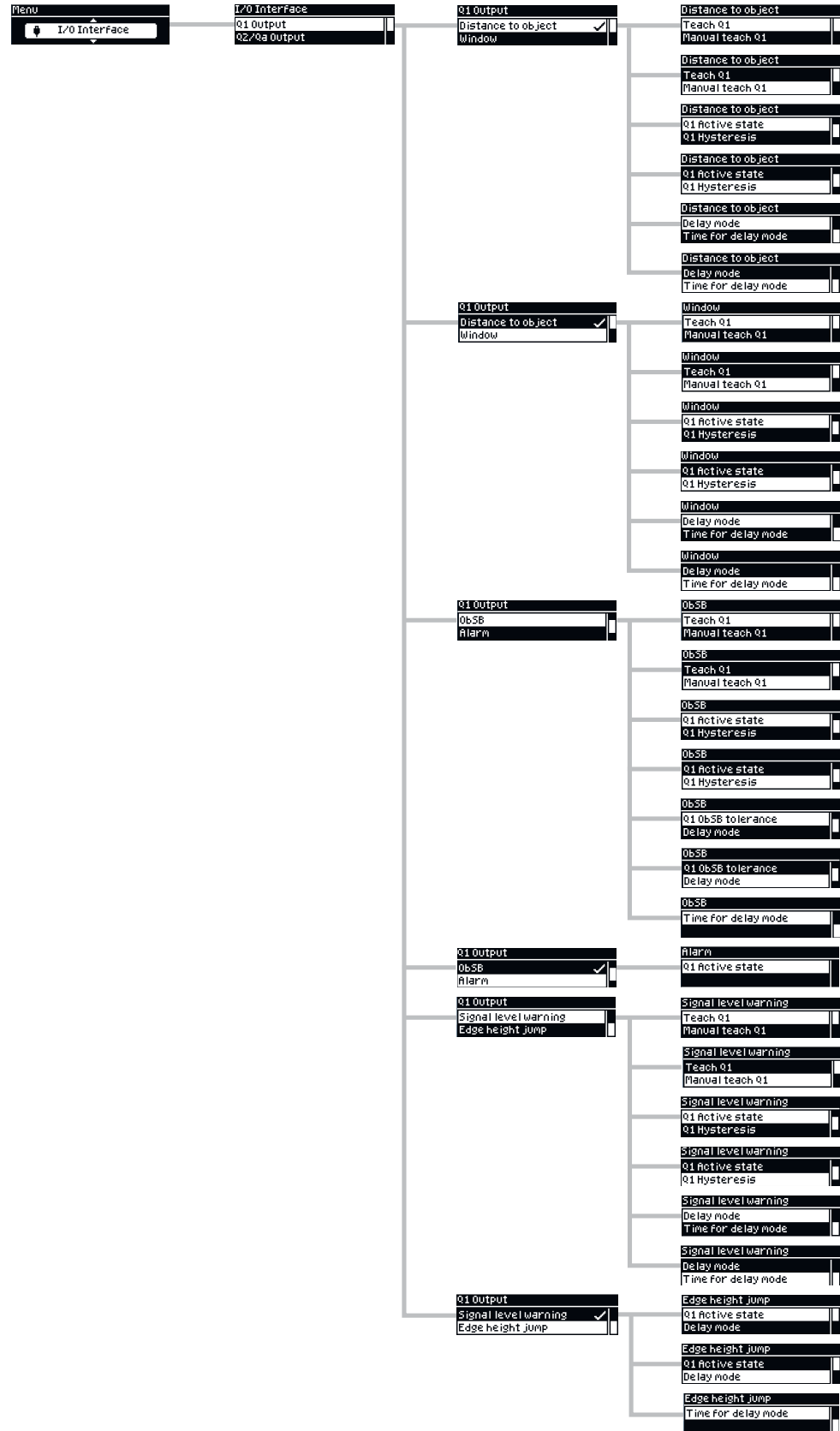

8.1.4 I/O interface menu group: Q2/Qa output, In1 input

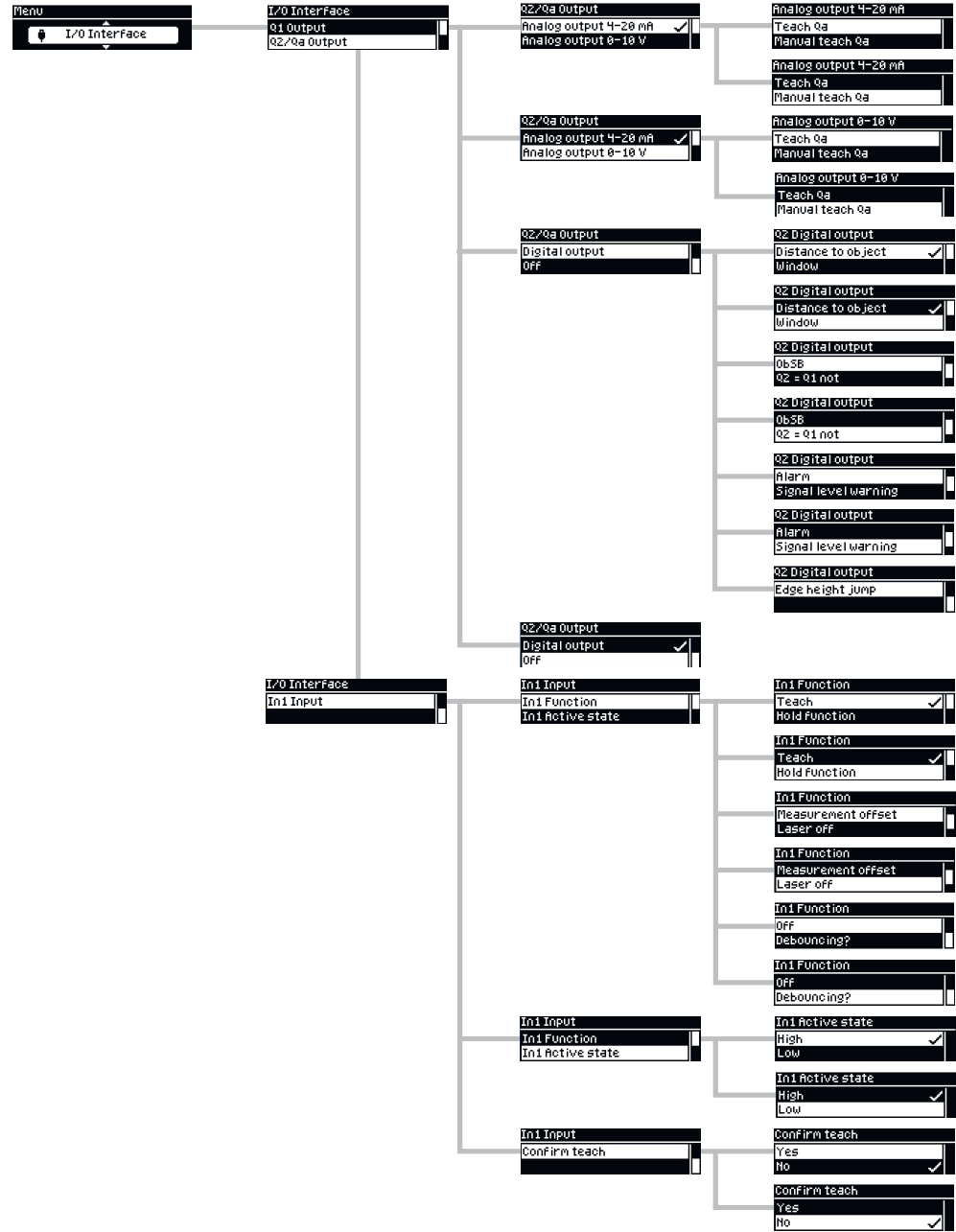

8.1.5 Device menu group

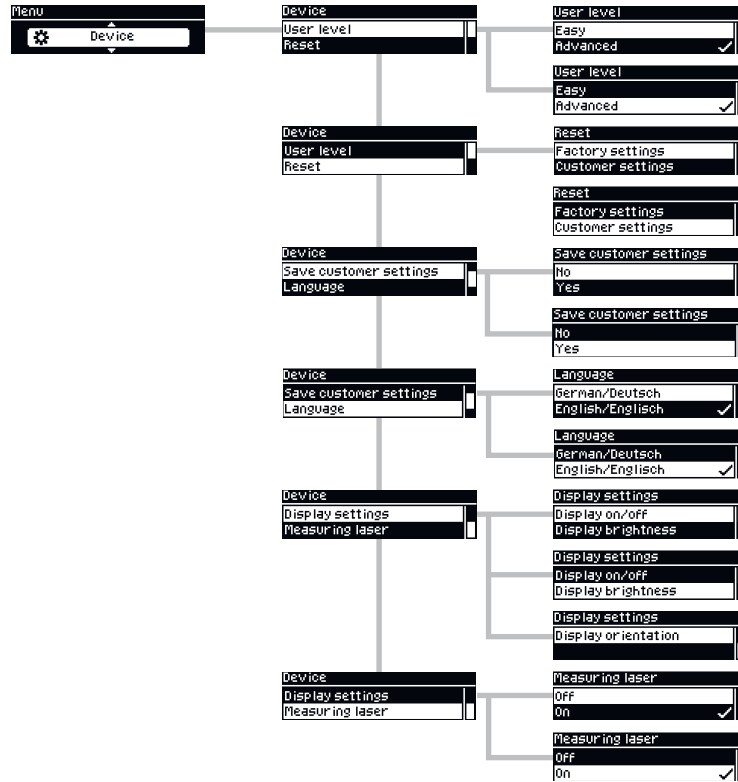

8.1.6 Communication menu group

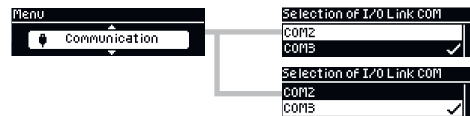

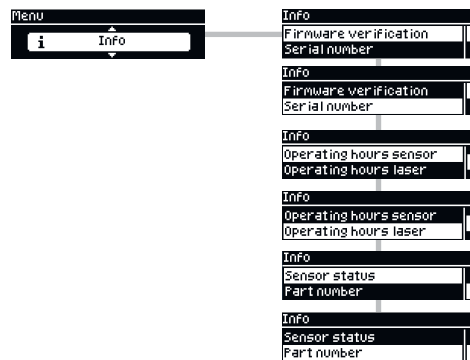

8.1.7 Info menu group



8.2 Main display level

As soon as voltage is supplied to the device, the display shows the main display level and a measured value is displayed.

The  /  pushbuttons can be used to switch between the following displays:

- Relative distance measured value:

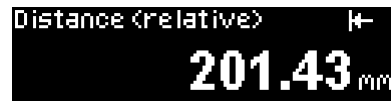

Distance (relative) ←
201.43 mm

The (relative) distance value always takes into account the set measured value offset.

- Absolute and relative distance measured value:



Distance ←
Absolute 365.5 mm
Relative 878.5

Simultaneous display of the distance without (absolute) and with (relative) the set measured value offset.

- Scaled analog value:



Scaled analog value ←
17.38 mA

The current output value is only displayed when the analog output is activated.

- Signal level:



Signal level ←
710



NOTE

The signal level corresponds to the amount of light received by the device's receiver optics. This is a dimensionless value. It essentially depends on the distance from the measuring object, the surface of the measuring object (color, roughness/gloss, angle to the optical axis), and the cycle time set on the device. To enable the device to measure the distance correctly, the signal level must not drop below a lower limit value. The dynamics of the device normally regulate the level to ensure an optimized value. Depending on the set cycle time, object properties, and object distance, the signal level may drop below the lower limit value and make it impossible to carry out a measurement. It may be possible to improve the measuring behavior by increasing the cycle time, optimizing the alignment of the device with the object, or reducing the distance to the measuring object.

- Distance visualization:

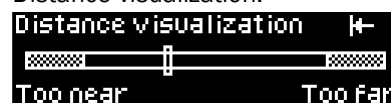

Distance visualization ←
Too near Too far

The cursor gives a qualitative indication of the position within the maximum measuring range.

- Temperature:

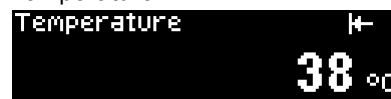

Temperature ←
38 °C

The value displays the temperature inside the device and is not relevant for the specified operating temperature range.

8.3 Measurement

8.3.1 Application settings

The functions are only available in the **Advanced** user level, see "Device", page 53.

8.3.1.1 Distance range

The “Distance range” function can be used to define an evaluation range in which the device measures object distances. All surrounding ranges are blanked. A typical application is the blanking of a transparent protective screen fitted between the object and the device.

During configuration, note that the application must take into account a tolerance range of 15 mm outside the set limits of the distance range. Reliable blanking and detection of objects cannot be guaranteed within this tolerance range.

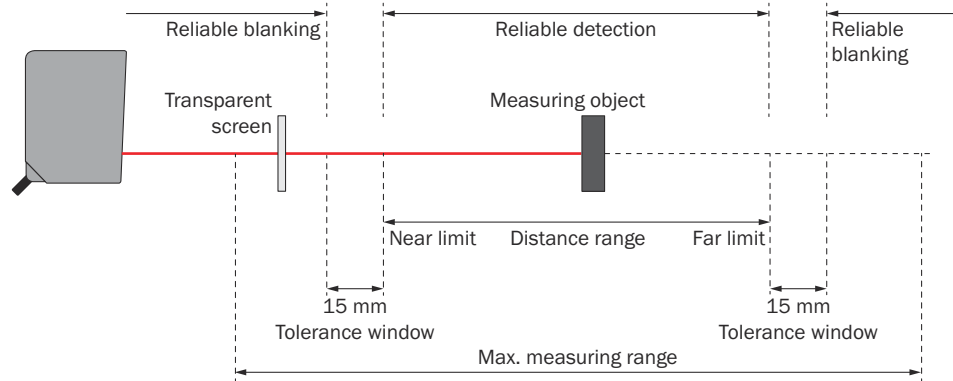

Figure 10: Blanking of a transparent protective screen by establishing the near limit and far limit of the distance range, taking into account the tolerance ranges

- ① Reliable blanking
- ② Reliable detection
- ③ Measuring object
- ④ Distance range
- ⑤ Far limit
- ⑥ Tolerance window
- ⑦ Maximum measuring range
- ⑧ Near limit
- ⑨ Transparent screen

Near limit and far limit

The **near limit** and **far limit** values are the distances in mm which define the limits of the evaluation range.



NOTE

As there are limited discretization steps, the device transfers the limit values entered to the next possible distance values (mm). The recalculated value is adopted by the device and is also shown on the display.

Simple configuration of the distance range is also possible via the SOPAS ET software, see "Operation via SOPAS ET", page 59.

OK > Measurement > OK > Application settings > OK > Distance range > OK > Near limit > OK



OK > Measurement > OK > Application settings > OK > Distance range > OK > Far limit > OK



The **near limit** and **far limit** parameters are device-dependent and are set to the physical limit in the factory settings. The functionality and linear behavior are available in the valid measuring range of 200 to 1,000 mm.

8.3.1.2 Edge height change

The edge height change function supplies a switching signal at the set device output as soon as there is a change in value between two measured values. A typical application for this function is counting shingles in printing applications. The device takes on the complex evaluation tasks carried out by the control system.

To use the edge height change function, configure the following settings on the device:

- Select the function on the digital output, [see "Edge height change", page 45](#)
- Set a fixed cycle time (recommended), [see "Cycle time", page 34](#)
- Set the minimum and maximum height change, [see "Edge height change", page 31](#)
- Set the hysteresis (if necessary), [see "Edge height change", page 31](#)
- Set the change direction (if necessary), [see "Edge height change", page 31](#)
- Set the cycle offset (if necessary), [see "Cycle time", page 34](#)

Min. / max. height change

The **min. height change** and **max. height change** values define the smallest and largest difference in mm. The two measured values must differ by this amount for there to be an edge height change. The function only takes into account the difference between two measured values and is independent of the absolute distance of the object.

[OK] > Measurement > [OK] > Application settings > [OK] > Edge height change > [OK] > Min. height change > [OK]



[OK] > Measurement > [OK] > Application settings > [OK] > Edge height change > [OK] > Max. height change > [OK]

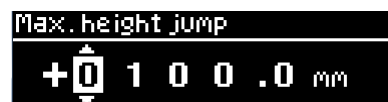

Parameter	Factory setting
Min. height change: -9,999.9 mm ... +9,999.9 mm	10 mm
Max. height change: -9,999.9 mm ... +9,999.9 mm	100 mm

Hysteresis

Hysteresis is the difference in distance between the switch-on and switch-off points. The hysteresis is necessary to ensure stable switching when the measured distance fluctuates around the switching point that has been set. Hysteresis can be configured

freely with most distance sensors and is stated in mm. More precise switching is achieved by setting a lower value. Set a higher value for the hysteresis to ensure more stable switching or reduce the probability of a faulty switch.

OK > Measurement > OK > Application settings > OK > Edge height change > OK > Hysteresis > OK



Parameter	Factory setting
0 mm ... +100 mm	0.5 mm

Change direction

The **change direction** value defines whether changes in measured values which result in smaller or larger distances are detected in both directions.

- both: All changes in measured values within the set limits are detected.
- Positive: Only changes in measured values within the set limits which result in larger distances are detected (description applies to factory setting).
- Negative: Only changes in measured values within the set limits which result in smaller distances are detected (description applies to factory setting).

OK > Measurement > OK > Application settings > OK > Edge height change > OK > Change direction > OK



Parameter	Factory setting
Both, positive, negative	Both

Cycle offset

The **cycle offset** value specifies which previous output value is compared with the value currently measured.



NOTE

We recommend using the edge height change operating mode with a fixed cycle time, see "Cycle time", page 34. This ensures time consistency for the output of measured values. In the **Auto** operating mode, fluctuating remission values of the object surface can change the cycle time of the device, which means that reliable detection cannot be guaranteed in the case of high detection speeds or small structures.

OK > Measurement > OK > Application settings > OK > Edge height change > OK > Cycle offset > OK



Parameter	Factory setting
1 ... 256	8

Examples of the digital output for the edge height change function

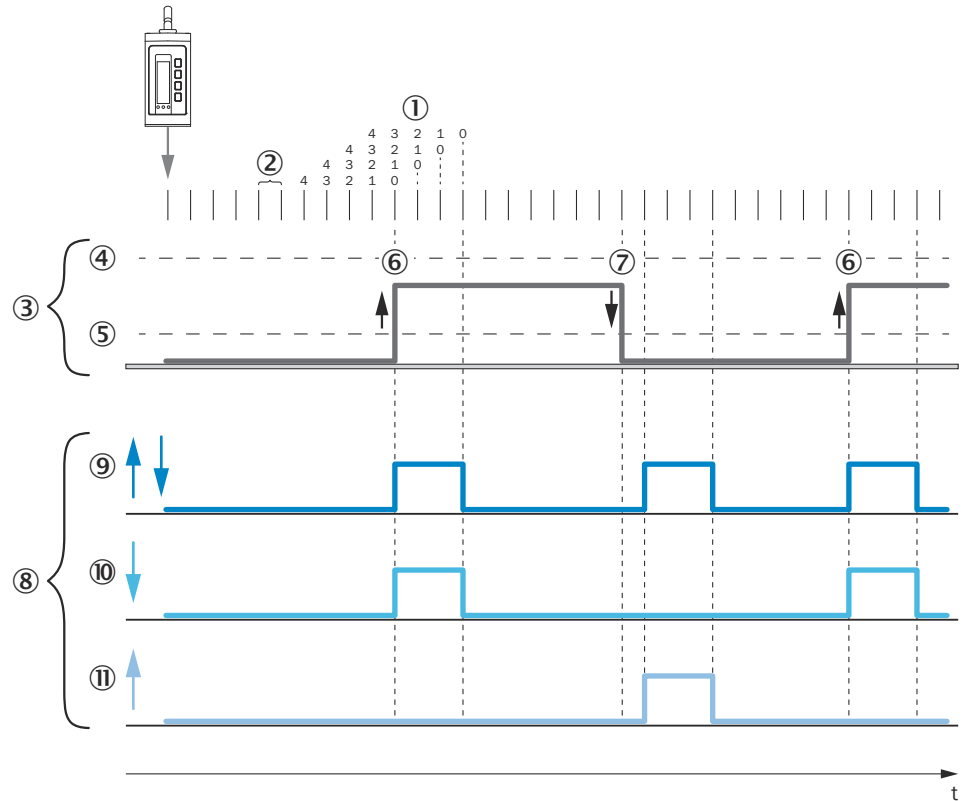

Figure 11: Edge height change - duration of the change in measured value is longer than the time span of the cycle offset

- ① Cycle offset: 4, without measured value filter
- ② Cycle time fixed, e.g. 1 ms
- ③ Signal diagram for real distance
- ④ Max. limit value for edge height change (mm)
- ⑤ Min. limit value for edge height change (mm)
- ⑥ Change in measured value, from large to small distance
- ⑦ Change in measured value, from small to large distance
- ⑧ Signal diagram for digital output
- ⑨ "Change direction: both" parameter
- ⑩ "Change direction: negative" parameter
- ⑪ "Change direction: positive" parameter

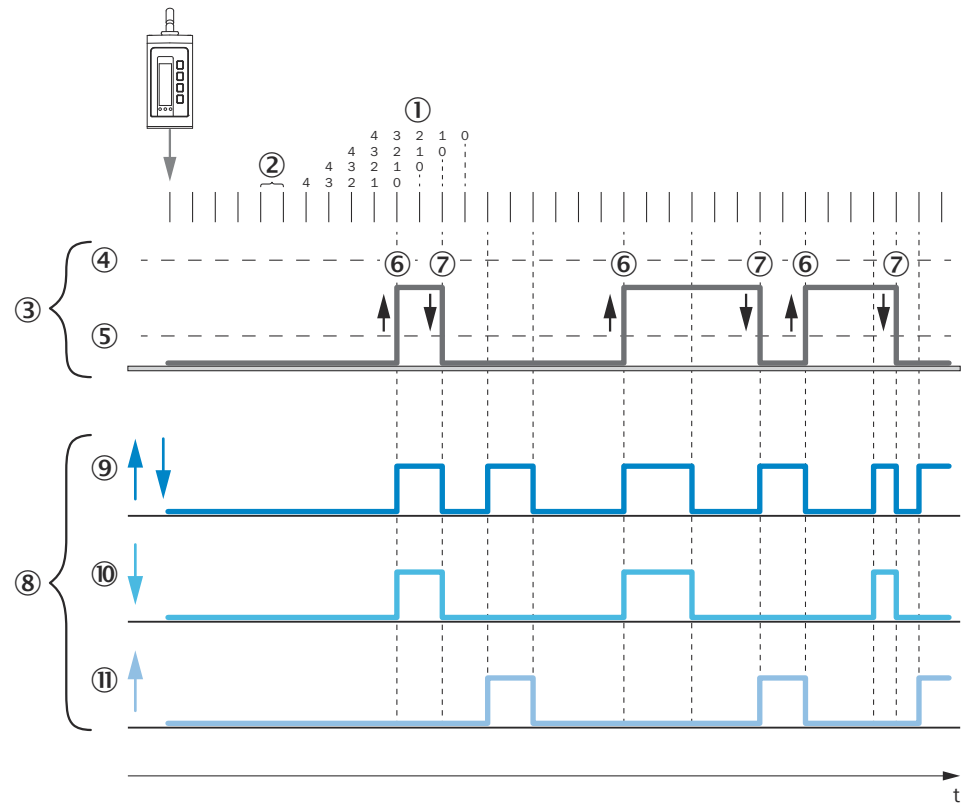

Figure 12: Edge height change - duration of the change in measured value is shorter than the time span of the cycle offset

- ① Cycle offset: 4, without measured value filter
- ② Cycle time fixed, e.g. 1 ms
- ③ Signal diagram for real distance
- ④ Max. limit value for edge height change (mm)
- ⑤ Min. limit value for edge height change (mm)
- ⑥ Change in measured value, from large to small distance
- ⑦ Change in measured value, from small to large distance
- ⑧ Signal diagram for digital output
- ⑨ “Change direction: both” parameter
- ⑩ “Change direction: negative” parameter
- ⑪ “Change direction: positive” parameter

8.3.2 Default settings

8.3.2.1 Cycle time

The **cycle time** defines the interval in which the device performs a measurement and essentially corresponds to the output rate of the measured values.

Available modes:

- Auto mode: The device adjusts itself to the maximum speed at which the device can achieve a stable measurement, depending on the object surface.



NOTE

In the **Auto** operating mode, the cycle time is adjusted dynamically so the output rate of the measured values can vary over time.

- Fixed setting: The device uses the set cycle time as a maximum, regardless of the object surface. The output rate of the measured values corresponds to the set value and remains constant.

**NOTE**

If the remission properties of the object are not sufficient to perform a valid measurement, the device outputs the value of an incorrect measurement, see "Action in case of incorrect measurements", page 38.

OK > Measurement > OK > Default settings > OK > Cycle time > OK



Parameter	Factory setting
Auto, 0.3 ms, 0.5 ms, 1 ms, 5 ms, 10 ms	Auto

8.3.2.2 Measured value filter

The measured value filters are used to optimize the signal diagram in order to simplify the evaluation by the control system, e.g., for regulation tasks.

Available measured value filters:

- Average filter The average filter carries out a moving averaging of the measured values. The average filter is suitable for smoothing a noisy signal diagram. This improves the repeatability of the measurement.
- Median filter: The moving median filter sorts the measured values according to their size and selects the middle value from a sequence. The median filter is suitable for excluding individual outliers from the calculation of an average value.

Both types of filter affect the response time of the distance sensor.

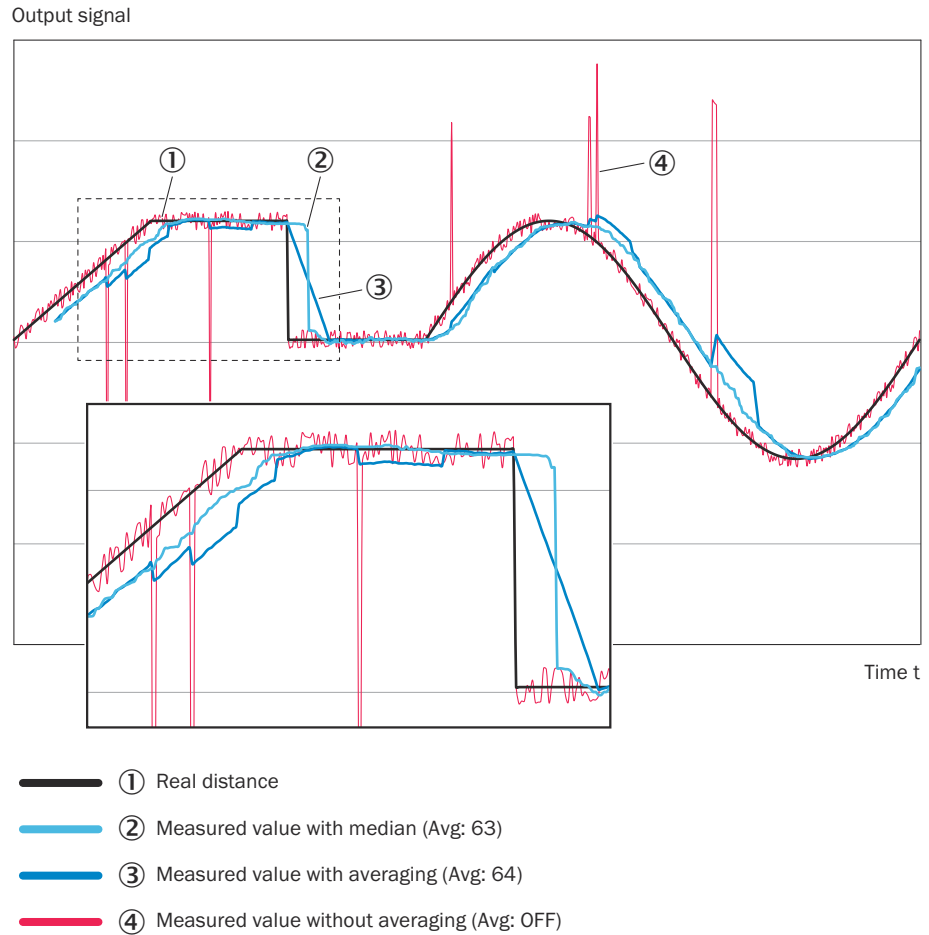

Figure 13: Measured value filter

- ① Output signal
- ② True distance
- ③ Measured value with median (avg: 63)
- ④ Measured value with averaging (avg: 64)
- ⑤ Measured value without averaging (avg: OFF)
- ⑥ Time t

OK > Measurement > OK > Default settings > OK > Measured value filter > OK

```
Measurement value Filter
No filter used      ✓
Average filter
```

Parameter	Factory setting
Do not use a filter	x
Averaging filter: 4, 8, 16, 32, 64, 512	-
Median filter: 3, 7, 15, 31, 63, 511	-

8.3.2.3 Bit filter

The bit filter for digital outputs determines how often an identical output state has to recur consecutively before the signal at the digital output changes accordingly.

If the defined number is not reached, the digital output remains unchanged. This may, for example, increase the reliability in the application if the distance value fluctuates around the selected switching point. This will not affect the cycle time or the output rate.

[OK] > Measurement > [OK] > Default settings > [OK] > Bit filter > [OK]



Parameter	Factory setting
On: 1 ... 32, off	2

8.3.2.4 Measuring direction

The function changes the plus/minus sign of the relative distance value depending on the direction from the center of the measuring range.

- Positive: Distances which are larger than the set zero position of the device are assigned a plus sign. Smaller distances are assigned a minus sign accordingly.
- Negative: Distances which are larger than the set zero position of the device are assigned a minus sign. Smaller distances are assigned a plus sign accordingly.

[OK] > Measurement > [OK] > Default settings > [OK] > Measuring direction > [OK]

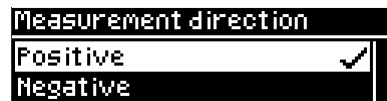

Parameter	Factory setting
Positive, negative	Positive

8.3.2.5 Measured value offset

The measured value offset moves the zero point of the device within the maximum measuring range. This makes it possible to measure absolute distance changes in relation to an individual reference distance.



NOTE

In the case of all offset settings, the current gradient of the analog characteristic curve remains unchanged.

Setting the measured value offset

A manual measured value offset may be set. The distance value that the distance sensor outputs and that is evaluated in the switching functions takes into account the set offset. Only absolute measured values are transferred via IO-Link communication.

Table 4: Example of measured value offset

	Distance (absolute)	Analog output	Set offset
In factory setting	600.0 mm	12.00 mA	-600.0 mm
With offset input +100.0 mm	600.0 mm	14.00 mA	-500.0 mm

[OK] > Measurement > [OK] > Default settings > [OK] > Measured value offset > [OK] > Set measured value offset > [OK]



Parameter	Factory setting
-1,000.0 m ... +1,000.0 m	-600.0 m

Teaching in the zero point

The current distance is taught in as a new zero point (reference point). When the analog output is activated, the analog value is set to the center of the measuring range at this distance (12 mA / 5 V).

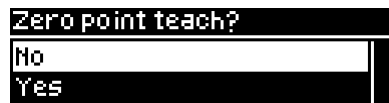
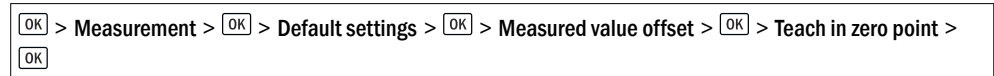

NOTE

This function can also be executed using a shortcut:

- ▶ In the main display level, press and hold the pushbutton for > 3 seconds until the relative distance value is set to 0.0 mm

Resetting the zero point

This resets the zero point to the center of the measuring range according to the factory setting.

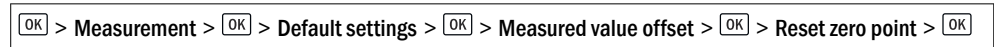

NOTE

This function can also be executed using a shortcut:

- ▶ In the main display level, press and hold the pushbutton for > 6 seconds until the relative distance value is set to the factory setting.

8.3.2.6 Action in case of incorrect measurements

If a distance measurement cannot be run, an error is output. Possible causes of the error:

- The measuring object is outside of the measuring range.
- The light signal received by the device is not strong enough.
- The laser is switched off.

You can configure the device behavior for the event that no measurement is possible. The following options are available:

- **Substitute value in the event of an error:** A numerical value can be entered which is output when no measurement is possible.
- **Error mode > User-defined values:** If no measurement is possible, the set **Substitute value in the event of an error** (see above) is displayed and held until a valid measured value is available again.
- **Error mode > Hold last value:** If no measurement is possible, the last valid measured value is displayed and held until a valid measured value is available again.
- **Error mode > Hold last value for a defined time:** If no measurement is possible, the last valid measured value is displayed and held for the time set under **Error suppression time** (see below). Once this time has elapsed, the set **Substitute value in the event of an error** (see above) is displayed and held until a valid measured value is available again.
- **Error suppression time:** It is possible to set a time for which the last valid measured value is displayed and held if the error mode **Hold last value for a defined time** (see above) is activated.

[OK] > Measurement > [OK] > Default settings > [OK] > Action in case of incorrect measurements > [OK]

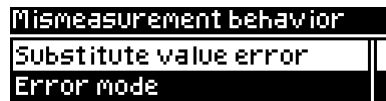

Parameter	Factory setting
Substitute value in the event of an error: -3,276.8 m ... +3,276.7 m	+3,276.7 m
Error mode: User-defined values Hold last value Hold last value for a defined time	✓ - -
Error suppression time: 0001 ms ... 9,999 ms	1 ms

8.4 I/O interface

8.4.1 Q1 output

The Q1 output is purely a digital output. In addition, the output serves as a communication line for bidirectional data transmission when using the IO-Link interface.

The Q1 output of the OD1000 provides the following switching modes:

- DtO, distance to object (1-point), one switching point
- Window, two switching points
- ObSB, object between sensor (device) and background, one switching point
- Alarm (only in **Advanced** user level)
- Signal level warning (only in **Advanced** user level)
- Edge height change (only in **Advanced** user level)

The switching modes are explained in the subsequent chapters.

8.4.1.1 Notes on the measuring and setting functions

The following functions can be set independently from each other on both outputs depending on the selected output function.

Delay mode

Delay mode is used to output the output state change with a time delay or as a short switching pulse (1 shot).

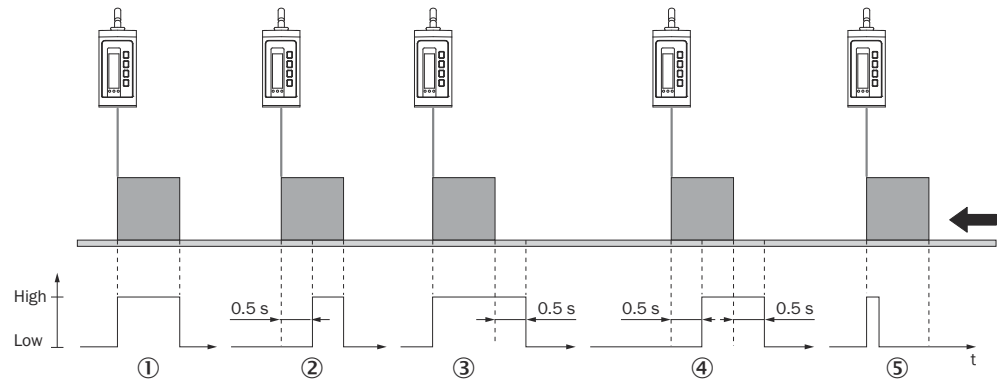

- ① **Off:** Right after the measured distance has exceeded the specified switching point, the state of the digital output changes (factory setting).
- ② **Switch-on delay:** The changeover of the digital output from an inactive to an active state is time-delayed. The delay time is adjustable. The changeover from an active to an inactive state is not delayed.
- ③ **Switch-off delay:** The changeover of the digital output from an active to an inactive state is time-delayed. The delay time is adjustable. The changeover from an inactive to an active state is not delayed.
- ④ **Switch-on/switch-off delay:** The changeover from an inactive to an active state and vice versa is time-delayed. The delay time is adjustable.
- ⑤ **1 shot:** Once the switching condition has been met, the digital output changes from an inactive to an active state. The output state remains in an active state for a specified period regardless of how long the switching condition is met. It does not switch back to an inactive state until this time has elapsed. Any additional changes made to the switching condition during this period are still not taken into account.



NOTE

For a combination of switch-on delay and switch-off delay, the following conditions must be met:

- Equidistant measuring frequency
- Min. 2x measuring frequency
- Cycle time must not be set to **AUTO**.

Active status

The active status describes the relationship between the output state (active or inactive) and the potential present on the digital output (high or low).

[OK] > I/O interface > [OK] > Q1 output > [OK] > Distance to object > [OK]

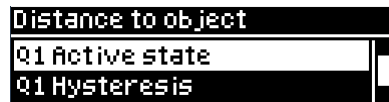

If the **Distance to object** switching mode is selected, the required settings can be taught in or set manually. These are described in the following.

8.4.1.2 Distance to object, DtO, single switching point

If the measured distance value has undershot (High Active) or exceeded (Low Active) the switching point, a signal is output.

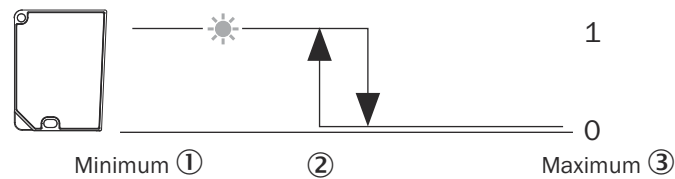

Figure 14: Distance to object or single switching point (normally open – High Active, PNP)

- ① Minimum
- ② Switching point
- ③ Maximum

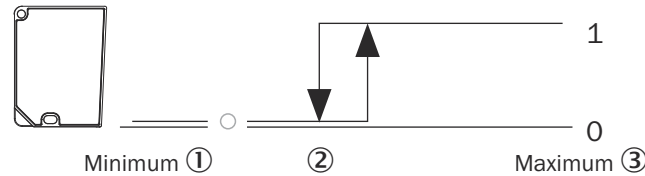

Figure 15: Distance to object or inverted single switching point (normally closed – Low Active, PNP)

- ① Minimum
- ② Switching point
- ③ Maximum

If the “Distance to object” switching mode is selected, the required settings can be taught in or set manually.

In the **Distance to object** operating mode, the following settings can be configured:

- Teach-in
- Manual teach-in
- Active status
- Hysteresis
- Delay mode
- Time for delay mode

The possible settings are described below.

Teach-in: A single switching point can be taught in. The switching point is set to the current distance at the time the button is pressed.

- Q1: If the switching point that has been taught in is undershot, a signal is output. Thus the output acts as a normally open contact (“High” active status).
- Q1not: If the switching point that has been taught in is exceeded, a signal is output. Thus the output acts as a normally closed contact (“Low” active status).

Manual teach-in: The distance of the switching point can be set manually in 1/10 mm.

Q1 active status: The active status specifies the functionality of the digital output, see ["Notes on the measuring and setting functions", page 39](#).

- High: The digital output acts as a normally open contact. If the switching point that has been taught in is undershot, a signal is output.
- Low: The digital output acts as a normally closed contact. If the switching point that has been taught in is exceeded, a signal is output.

Delay mode

- see ["Notes on the measuring and setting functions", page 39](#) .

Time for delay mode

- The time for the delay mode can be set manually in ms.

[OK] > I/O interface > [OK] > Q1 output > [OK] > Distance to object > [OK]

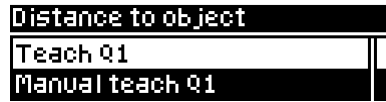

Parameter	Factory setting
Q1 teach-in: Q1, Q1 not	-
Manual Q1 teach-in: -1,000.0 mm ... +1,000.0 mm	+400 mm
Q1 active status: High, Low	High
Q1 hysteresis: 0000.0 mm ... +0100.0 mm	+1.0 mm
Delay mode: Off Switch-on delay Switch-off delay Switch-on/switch-off delay 1 shot	✓ - - - -
Time for delay mode: 0000 ms ... 9,999 ms	100 ms

8.4.1.3 Window

Window mode: An upper and a lower switching threshold are set for the digital output. If the measured value is between the two switching thresholds (within the window), a switching signal is output.

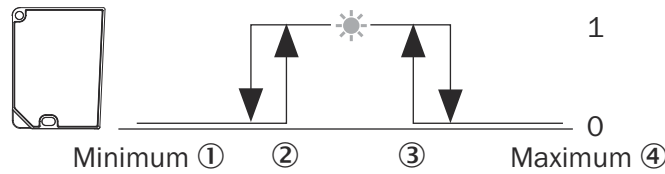

Figure 16: Normally open switching window (High Active, PNP)

- ① Minimum
- ② Switching point near
- ③ Switching point far
- ④ Maximum

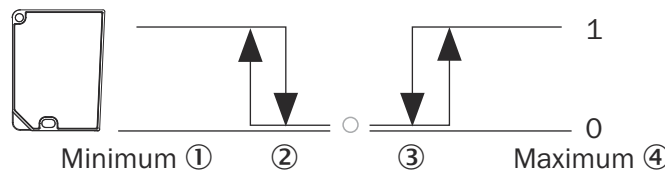
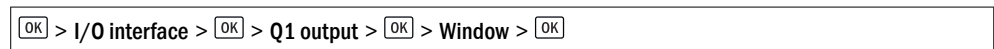

Figure 17: Normally closed switching window (Low Active, PNP)

- ① Minimum
- ② Switching point near
- ③ Switching point far
- ④ Maximum





Parameter	Factory settings
Q1 teach-in: Switching point 1, switching point 2	-
Manual Q1 teach-in: Switching point 1: -1,000.0 mm ... +1,000.0 mm Switching point 2: -1,000.0 mm ... +1,000.0 mm	+400.0 mm -400.0 mm
Q1 active status: High, Low	High
Q1 hysteresis: 0000.0 mm ... +0100.0 mm	+1.0 mm
Delay mode: Off Switch-on delay Switch-off delay Switch-on/switch-off delay 1 shot	✓ - - - -
Time for delay mode: 0 ms ... 9,999 ms	100 ms

8.4.1.4 ObSB (object between sensor and background)

Object between device and background: In this switching mode, any background can be taught in as a reference. If an object obscures the background or the distance to the background changes significantly, this causes the device to switch. This switching mode is primarily suited to the reliable detection of high-gloss or extremely dark materials. This makes it possible to detect even painted vehicle parts with large approach angles, for example.

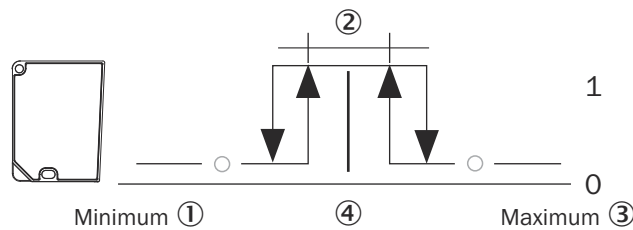

Figure 18: Object between device and background (normally open – High Active, PNP)

- ① Minimum
- ② Tolerance around teach point: ± 4.0 mm
- ③ Maximum
- ④ Switching point (reference background)

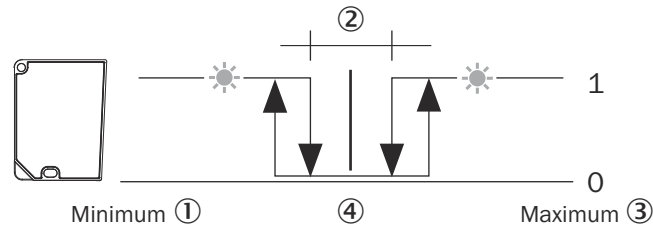

Figure 19: Object between device and background (normally closed – Low Active, PNP)

- ① Minimum
- ② Tolerance around switching point: ± 4.0 mm
- ③ Maximum
- ④ Switching point (reference background)

[OK] > I/O interface > [OK] > Q1 output > [OK] > ObSB > [OK]

```

ObSB
Teach Q1
Manual teach Q1
    
```

Parameter	Factory setting
Q1 teach-in: Q1, Q1 not	-
Manual Q1 teach-in: -1,000.0 mm ... +1,000.0 mm	+400 mm
Q1 active status: High, Low	High
Q1 hysteresis: 0000.0 mm ... +0100.0 mm	+1.0 mm
Q1 ObSB tolerance -1,000.0 mm ... +1,000.0 mm	+4.0 mm
Delay mode: Off, switch-on delay, switch-off delay, switch-on/switch-off delay, 1 shot	Off
Time for delay mode: 0000 ms ... 9,999 ms	100 ms

8.4.1.5 Alarm

The alarm function is only available in the **Advanced** user level. A constant switching signal is output at the output of the device while no measurement is possible. This function can be used to evaluate the measured value at the analog output, for example.

[OK] > I/O interface > [OK] > Q1 output > [OK] > Alarm > [OK]

```

Q1 Output
ObSB
Alarm
    
```

Parameter	Factory settings
Alarm	Off

8.4.1.6 Signal level warning

The signal level warning function is only available in the **Advanced** user level.

A warning can be output via the Q1 and Q2 digital outputs if the signal level drops below a certain value. This value can either be specified as a number value or determined by the **Teach-in** function. When the **Teach-in** function is used, the threshold value for outputting the warning is calculated by reducing the measured signal level value by about 12%. Then the warning will not be output until the signal level is about 12% lower than it was at the time it was taught in.

The level warning threshold or signal level switching point can be set manually using a signal level within the value range of 0 to 5,000. The signal level is a sensor-specific, unitless value. We recommend configuring the setting using application-specific test measurements.

In automated mode, the device automatically regulates the reception level to around 1,000. In the case of very critical object surfaces, an abrupt loss of signal can therefore occur as soon as a readjustment is no longer possible. In settings other than **Auto**, there is no automatic adjustment, which makes it easier to define thresholds for the signal level warning.

OK > I/O interface > OK > Q1 output > OK > Signal level warning > OK

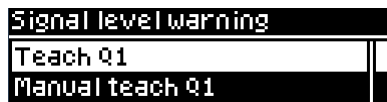

Parameter	Factory settings
Q1 teach-in: Switching point 1, switching point 2	-
Manual Q1 teach-in: -0 ... 5,000	112
Q1 active status: High, Low	High
Q1 hysteresis: 0 ... 10,000	10
Delay mode: Off, switch-on delay, switch-off delay, switch-on/switch-off delay, 1 shot	Off
Time for delay mode: 0000 ms ... 9,999 ms	100 ms

8.4.1.7 Edge height change

The edge height change function is only available in the **Advanced** user level, see "Device", page 53.

OK > I/O interface > OK > Q1 output > OK > Edge height change > OK



Parameter	Factory settings
Q1 active status: High, Low	High
Delay mode: Off, switch-on delay, switch-off delay, switch-on/switch-off delay, 1 shot	Off

Parameter	Factory settings
Time for delay mode: 0000 ms ... 9,999 ms	100 ms

8.4.2 Q₂ / Q_a output

The Q₂ / Q_a output can be configured either as an analog output or as a digital output.

8.4.2.1 Notes on the output functions

8.4.2.1.1 4-20 mA output function

If the 4-20 mA setting is selected, output 2 functions as an analog current output. The measured value of the device is output as a proportional-linear current value that corresponds to the other device settings.

8.4.2.1.2 0-10 V output function

If the 0 - 10 V setting is selected, output 2 functions as an analog voltage output. The measured value of the device is output as a proportional-linear voltage value that corresponds to the other device settings.

8.4.2.1.3 Digital output function

In the case of the digital output function, output 2 functions as a digital output. Since output 1 is used exclusively for switching, this setting corresponds to the behavior of output 1. A switching signal that corresponds to the other device settings is output based on the current measured value.

8.4.2.1.4 Off output function

When the **Off** output function is activated, output 2 does not have any function and is therefore deactivated.

8.4.2.2 4-20 mA analog output

OK > I/O interface > OK > Q2/Qa output > OK > 4-20 mA analog output > OK

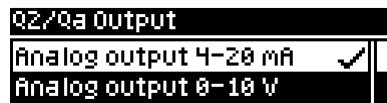

Parameter	Factory setting
Qa teach-in: Distance (4 mA) Distance (20 mA)	- -
Manual Qa teach-in: Distance (4 mA): -1,000.0 mm ... +1,000.0 mm Distance (20 mA): -1,000.0 mm ... +1,000.0 mm	-400.0 mm +400.0 mm

8.4.2.3 0-10 V analog output

OK > I/O interface > OK > Q2/Qa output > OK > 0-10 V analog output > OK

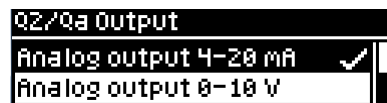

Parameter	Factory setting
Qa teach-in: Distance (0 V) Distance (10 V)	- -
Manual Qa teach-in: Distance (0 V): -1,000.0 mm ... +1,000.0 mm Distance (10 V): -1,000.0 mm ... +1,000.0 mm	-400.0 mm +400.0 mm

8.4.2.4 Digital output

The Q2 digital output provides the following switching modes:

- DtO, distance to object (1-point), one switching point
- Window, two switching points
- ObSB, object between sensor (device) and background, one switching point
- Q2 = Q1 not
- Alarm (only in **Advanced** user level)
- Signal level warning (only in **Advanced** user level)
- Edge height change (only in **Advanced** user level)

OK > I/O interface > OK > Q2/Qa output > OK > Digital output > OK

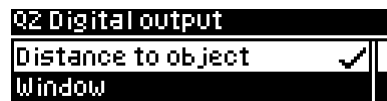

Parameter	Factory setting
Distance to object > Q2 teach-in: Q2, Q2 not	-
Distance to object > manual Q2 teach-in: -1,000.0 mm ... +1,000.0 mm	+400.0 mm
Distance to object > Q2 active status: High, Low	High
Distance to object > Q2 hysteresis: 0000.0 mm ... +0100.0 mm	+1.0 mm
Distance to object > delay mode: Off, switch-on delay, switch-off delay, switch-on/switch-off delay, 1 shot	Off
Distance to object > time for delay mode: 0000 ms ... 9,999 ms	100 ms
Window > Q2 teach-in: Switching point 1, switching point 2	-
Window > manual Q2 teach-in: Switching point 1, switching point 2	-
Window > Q2 active status: High, Low	High
Window > Q2 hysteresis: 0000.0 mm ... +0100.0 mm	+1.0 mm
Window > delay mode: Off, switch-on delay, switch-off delay, switch-on/switch-off delay, 1 shot	Off
Window > time for delay mode: 0000 ms ... 9,999 ms	100 ms

Parameter	Factory setting
ObSB > Q2 teach-in: Q2, Q2 not	-
ObSB > manual Q2 teach-in: -1,000.0 mm ... +1,000.0 mm	+400.0 mm
ObSB > Q2 active status: High, Low	High
ObSB > Q2 hysteresis: 0000.0 mm ... +0100.0 mm	+1.0 mm
ObSB > Q2 ObSB tolerance -1,000.0 mm ... +1,000.0 mm	+4.0 mm
ObSB > delay mode: Off, switch-on delay, switch-off delay, switch-on/switch-off delay, 1 shot	Off
ObSB > time for delay mode: 0000 ms ... 9,999 ms	100 ms

8.4.2.5 Off

When the **Off** output function is activated, output 2 does not have any function and is therefore deactivated.

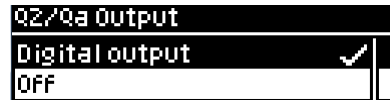

8.4.3 In1 input

8.4.3.1 Notes on the input functions

8.4.3.1.1 Description

The In1 input is used for the following tasks:

- Configuration of various device parameters, see "Teach-in", page 50
- Switching the laser on or off at defined times

If the function is set to **Teach** (factory setting), the specific parameters or different measured value hold functions can be configured by creating signal levels of different lengths at pin 5. If the function is set to **Laser off**, when a signal is created the laser is switched off for the duration of the created signal.

The In1 input must be active in order to be used accordingly (every setting apart from **Off**). The **Off** setting deactivates the input and, therefore, all functions.



NOTE

Deactivating the input is possible only via the display, SOPAS ET, or IO-Link, but not via the input itself.

The input behavior can be selected as normally open (High Active, factory setting) or normally closed (Low Active). When **Laser off** is used, the logic also determines whether the creation of a signal at the input causes the laser to switch off (factory setting) or on.

8.4.3.1.2

Hold function

The following hold functions are available:

- Measured value: Holds the measured value which is present when there is a hold input signal (rising edge).

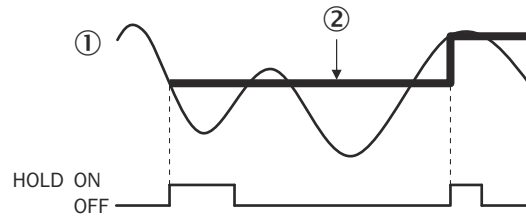

- ① Measured value
- ② Output hold value (sample hold value)

- Peak value: Holds the largest measured value which is present in the interval between the last falling edge and the hold input signal (next rising edge).

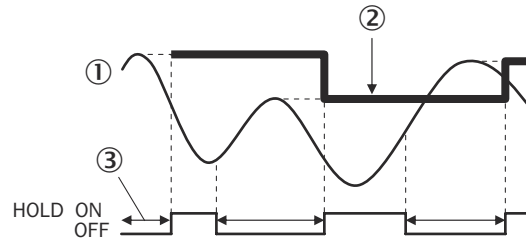

- ① Measured value
- ② Output hold value (peak hold value)
- ③ Interval in which an analysis is carried out.

- Lowest value: Holds the smallest measured value which is present in the interval between the last falling edge and the hold input signal (next rising edge).

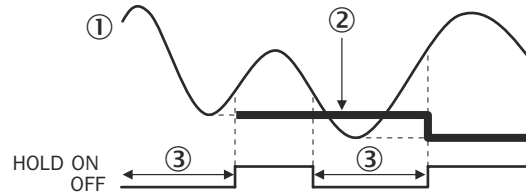

- ① Measured value
- ② Output hold value (bottom hold value)
- ③ Interval in which an analysis is carried out.

- Peak-to-peak value: Holds the differential value between the smallest and the largest measured value present in the interval between the last falling edge and the hold input signal (next rising edge).

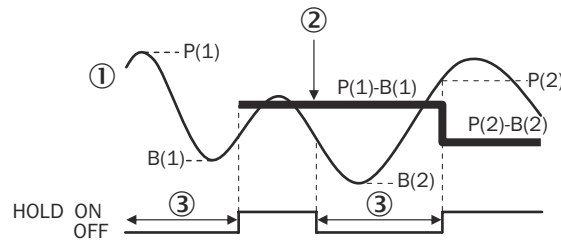

- ① Measured value
- ② Output hold value (peak-to-peak hold value)
- ③ Interval in which an analysis is carried out.

- Average value: Holds the mathematical average of all measured values present in the interval between the last falling edge and the hold input signal (next rising edge).

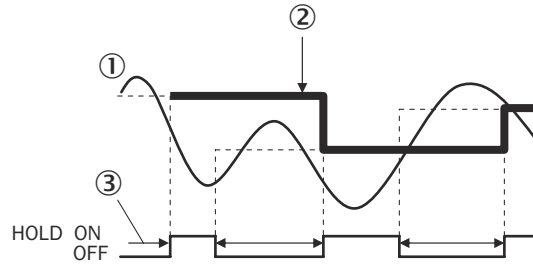

- ① Measured value
- ② Output hold value (average hold value)
- ③ Interval in which an analysis is carried out.

8.4.3.1.3 Teach-in

Description

In the **Teach-in** operating mode you can use various teach functions by creating signal levels of various lengths at the In1 input.

The timing tolerance for all teach functions is +/- 20 ms.

The following functions are available:

Teach function	Time [ms]
Switching off laser	200
Switching on laser	300
Distance to object for Q ₁ : Teach Q	400
Distance to object for Q ₁ : Teach Q not	500
Switching window for Q ₁ : Teach Q near	600
Switching window for Q ₁ : Teach Q far	700
ObSB (Background) for Q ₁ : Teach Q	800
ObSB (Background) for Q ₁ : Teach Q not	900
Switching window for Q ₁ : Centering teach	1000
Distance to object for Q ₂ : Teach Q	1100
Distance to object for Q ₂ : Teach Q not	1200
Switching window for Q ₂ : Teach Q near	1300
Switching window for Q ₂ : Teach Q far	1400
ObSB (Background) for Q ₂ : Teach Q	1500
ObSB (Background) for Q ₂ : Teach Q not	1600
Switching window for Q ₂ : Centering teach	1700
Q _A with 4-20 mA for Q ₂ : Teach 4 mA	1800
Q _A with 4-20 mA for Q ₂ : Teach 20 mA	1900
Q _A with 0-10 V for Q ₂ : Teach 0 V	2000
Q _A with 0-10 V for Q ₂ : Teach 10 V	2100
Q _A (4-20 mA or 0-10 V): Centering teach	2200
Switching off teach confirmation	2300

Teach function	Time [ms]
Switching on teach confirmation	2400
Signal level warning Q ₁ : Teach Q	2500
Signal level warning Q ₁ : Teach Q not	2600
Signal level warning Q ₂ : Teach Q	2700
Signal level warning Q ₂ : Teach Q not	2800
Teaching in the zero point	2900
Laser off	> 5,000

¹ Centering limits. The near and far points that have been moved via centering must always lie within the value range limits. Moved points must always be evaluated by the user.

8.4.3.2 In1 function

Use the In1 function for the following tasks:

- Configure various device parameters
- Switch the laser on and off at defined times
- Activate device functions
- Activate and deactivate the debounce function

> I/O interface > > In1 input > > In1 function >

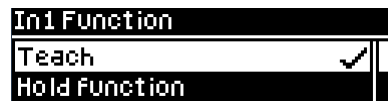

Parameter	Factory setting
Teach-in	✓
Hold function	-
Measured value offset	-
Laser off	-
Off	-

Debouncing

The debounce function is only available in the **Advanced** user level.

When debouncing is activated, the input signal must be applied constantly to input In1 for 30 ms. The timing tolerances of the external teach-in functions take into account an activation or deactivation of the debounce function. It is not necessary to adjust the timings.

> I/O interface > > In1 input > > In1 function > > Debouncing >



Parameter	Factory setting
Debouncing?: Yes, no	Yes

8.4.3.3 In1 active status

The input behavior can be selected as normally open (High Active, factory setting) or normally closed (Low Active).

OK > I/O interface > OK > In1 input > OK > In1 active status > OK



Parameter	Factory setting
High, Low	High

8.4.3.4 Teach confirmation

If the **Teach-in confirmation** function is activated, a confirmation can be output via the digital output Q1 for each teach-in via the In1 input.

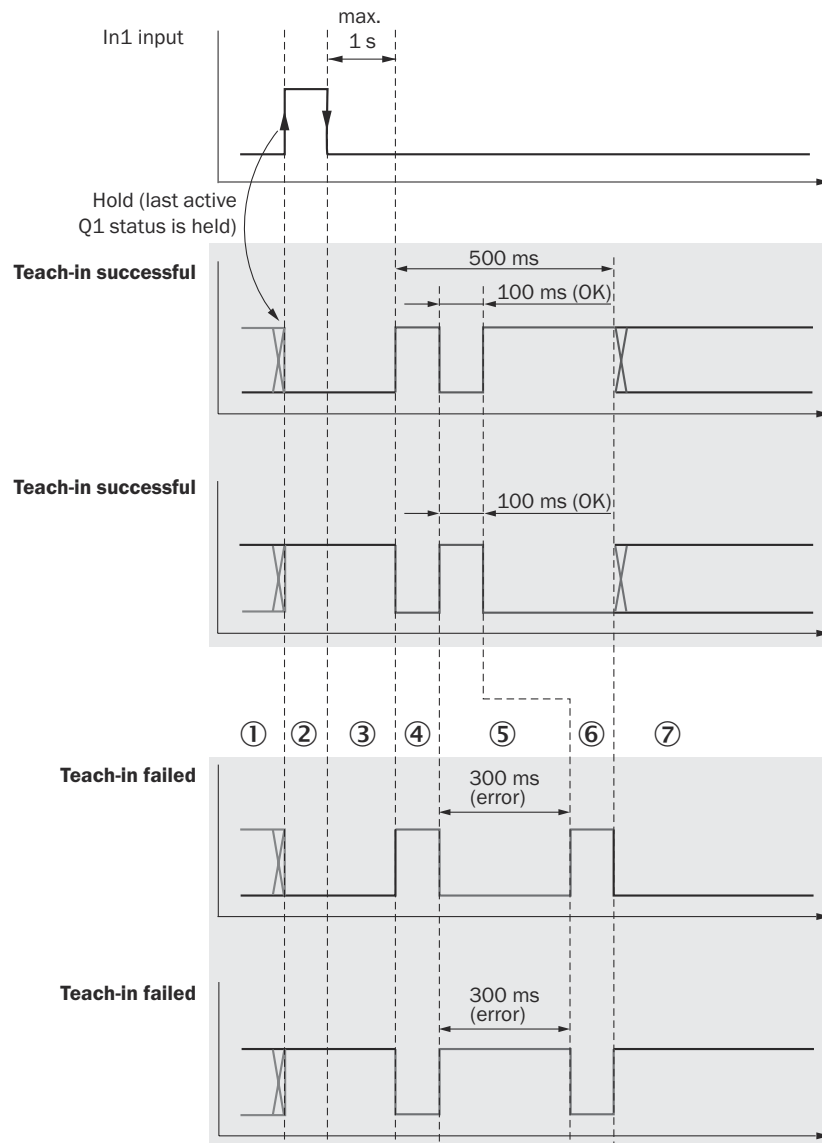
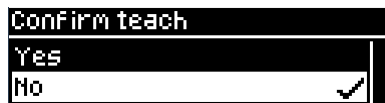

Figure 20: Teach confirmation

- ① Input In1
- ② Hold (last active Q1 status is held)
- ③ Teach-in successful
- ④ Digital output before teach-in

- ⑤ Teach-in request retains the last active Q₁ status in order, for example, to avoid toggling if hysteresis is too low.
- ⑥ Teach-in execution time, max. 1 s
- ⑦ First signal edge at Q₁ after starting the teach-in: Initiate confirmation by inverting for 100 ms.
- ⑧ Result: OK (100 ms), error (300 ms)
- ⑨ Quit confirmation after 500 ms.
- ⑩ Return to current digital output. The digital output can be modified via a new teach-in point.
- ⑪ Teach-in failed
- ⑫ Error

OK > I/O interface > OK > In1 input > OK > Teach confirmation > OK



Parameter	Factory setting
Yes, no	No

8.5 Device

8.5.1 User level

Simple and Advanced user levels are available.

Only certain functions are available depending on the user level set:

- Easy: frequently required functions (factory setting)
- Advanced: virtually all available functions

Changing the user level only affects operation via the display and via SOPAS ET. All functions are available at all times for operation and configuration via IO-Link.

OK > Device > OK > User level > OK



Parameter	Factory setting
Easy, Advanced	Easy

8.5.2 Reset

The device can be reset to the **factory settings** or to saved **customer settings** (see "Saving customer settings", page 54).



NOTE

Upon confirmation that the device is to be reset, it carries out a warm start. During the device restarting process, the device and its function are temporarily deactivated.

OK > Device > OK > Reset > OK > Factory settings > OK



[OK] > Device > [OK] > Reset > [OK] > Customer settings > [OK]



Parameter	Factory setting
Yes, no	-

8.5.3 Saving customer settings

Once settings have been made, they can be saved as customer settings. These settings can be restored at any time via **Reset > Customer settings**.

[OK] > Device > [OK] > Save customer settings > [OK]

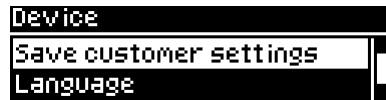

Parameter	Factory setting
No, yes	-

8.5.4 Language

The language of the display texts can be set.

[OK] > Device > [OK] > Language > [OK]



Parameter	Factory setting
Deutsch/German, Englisch/English	Englisch/English

8.5.5 Display settings

Settings can be made for the alignment, brightness, and switch-on/switch-off behavior of the display.

Description of the parameters for the **switch display on/off** function:

- **Auto:** The display switches itself off if no buttons are pressed for 3 minutes. The display switches on again when a button is pressed.
- **Off:** The display switches itself off when the button lock is activated. If the button lock is not activated, the display switches itself off if no buttons are pressed for 3 minutes. The display switches on again when a button is pressed.
- **On:** The display remains permanently on. This setting is not recommended as it can reduce the service life of the OLED display.

[OK] > Device > [OK] > Display settings > [OK]

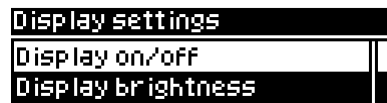

Parameter	Factory setting
Switch display on/off: Auto, off, on	Auto
Display brightness: 0% ... 100%	50%
Display alignment: 0°, 180°	0°

8.5.6 Measurement laser

The measurement laser can be switched off. No measurement is possible when the laser is switched off.



NOTE

The laser can also be switched on/off via the In1 input.

[OK] > Device > [OK] > Measurement laser > [OK]



Parameter	Factory setting
Off, on	On

8.6 Communication

IO-Link COM selection

The IO-Link communication mode of the device can be set. Associated IODD device description files are available on the website, see www.sick.com/OD1000.

[OK] > Communication



Parameter	Factory setting
COM2, COM3	COM3

8.7 Info

Various types of status information are displayed for the device.

8.7.1 Firmware verification

The firmware version of the device is displayed.

[OK] > Info > [OK] > Firmware verification > [OK]



8.7.2 Serial number

The serial number of the device is displayed.



8.7.3 Sensor operating hours

The operating hours of the device are displayed.

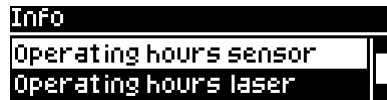
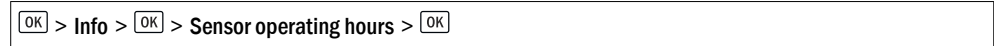

8.7.4 Laser operating hours

The operating hours of the laser are displayed.

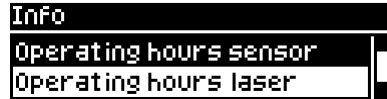

8.7.5 Sensor status

Information about the status of the device is displayed.

The following data can be accessed:

- Number of errors: States the number of errors that have occurred
- Number of warnings: States the number of active warnings
- Error history: Detailed information and history of the most recent errors (max. 10)



Parameter	Factory setting
Number of errors, number of warnings, error history	-

8.7.6 Part number

The part number of the device is displayed.



Info	
Sensor status	
Part number	

9 Operation via IO-Link

The device can exchange process data and parameters via IO-Link. To do this, it is connected to a suitable IO-Link master.

The IO-Link interface of the device has the following properties:

Table 5: Properties of the IO-Link interface

IO-Link specification	V 1.1 V 1.0
Minimum cycle time	2.3 ms (COM2) 0.46 ms (COM3)
Transmission rate	adjustable COM2 (38.4 kBaud) COM3 (230.4 kBaud)
Process data width	16-bit outgoing (from the device to the master)
Process data type	INT (signed integer)
Parameter configuration server function (data storage)	Yes

9.1 Process data

In the factory settings, the process data telegram displays the distance value measured by the device in millimeters (16-bit width unsigned).

By configuring the parameters of the device you can change the process data format as well as resolution and offset for the distance value.

The following process data formats are available:

Table 6: Process data formats

No.	Description	Comments
1	Distance (16-bit)	Factory setting
2	Level (16-bit)	-
3	Timer (16-bit)	-
4	Edge height change (16-bit)	-
5	Distance (14-bit) + Status Q ₁ + Status Q ₂	-
6	Level (14-bit) + Status Q ₁ + Status Q ₂	-
7	Timer (14-bit) + Status Q ₁ + Status Q ₂	-
8	Edge height change (14-bit) + Status Q ₁ + Status Q ₂	-

9.2 Device data

In addition to the process data, device data (parameters, identification data, and diagnostic information) can be transmitted to and from the device. To use this function, a sensor-specific device description file (IODD) is needed in the IO-Link master.

A download package with the IODD and supplementary documentation is available at www.sick.com/OD1000.

10 Operation via SOPAS ET

Use version 3.3 or higher of the SOPAS Engineering Tool (SOPAS ET) software to parameterize the device and for service and diagnostic purposes.

The following are required to configure the device parameters using a computer:

- A computer with the SOPAS ET software installed on it, and a free USB 2.0 compatible port
- SICK SiLink2 Master (part number 1061790)
- Connection cable with M12 male and female connectors, 5-pin (e.g., part number 6025930)

Establishing a connection:

1. Connect the device to the SiLink2 Master via the plug connection or an additional connection cable.
2. Connect the SiLink2 Master to the computer using the supplied USB cable.
3. To ensure an adequate voltage supply to the device, also connect the enclosed wall plug to the SiLink2 Master.



NOTE

The most up-to-date version of the SOPAS ET software can be downloaded from www.sick.com/SOPAS_ET. The respective system requirements for installing SOPAS ET are also specified there.



NOTE

To use SOPAS ET with the device, you need a device description file (*.sdd) for this device. You can install the device description file within SOPAS ET using the device catalog. An Internet connection is required to install the device description file.

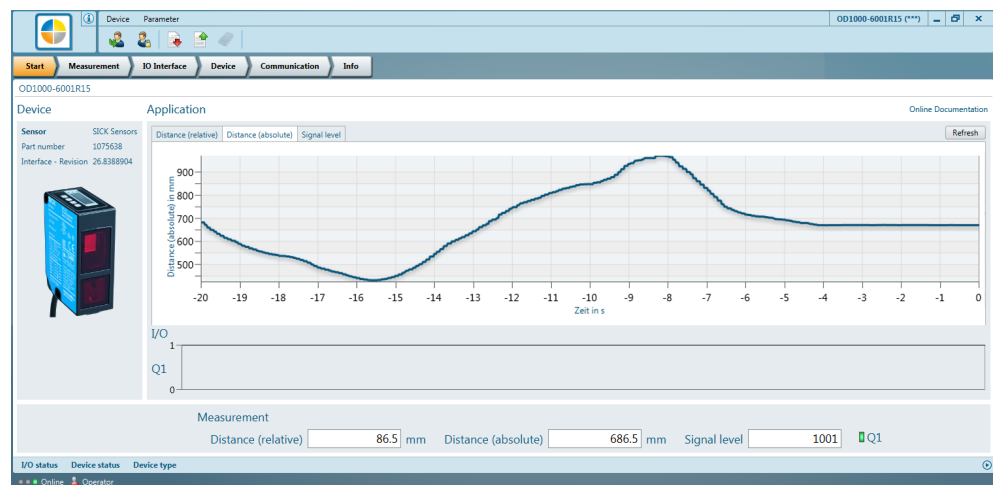

Figure 21: SOPAS ET start screen – visualization of the distance values and the output state

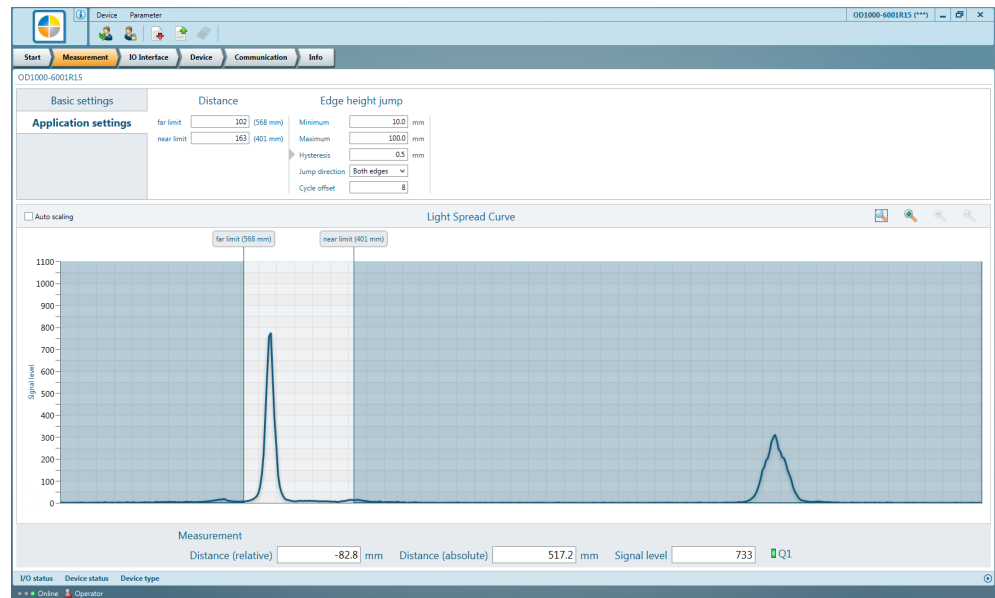

Figure 22: SOPAS ET function menus – visualization of the light distribution curve on the receiver for easy setting of the distance range



NOTE

The device immediately applies parameters that have been modified using SOPAS ET and permanently saves them. This does not require calling up a separate function.

As well as visualizing the measured values, all device functions can also be set and checked in SOPAS ET. SOPAS ET is particularly useful for configuring the distance range and edge height change functions, which are only available in the **Advanced** user level.

11 Maintenance

11.1 Cleaning



NOTICE

Equipment damage due to improper cleaning.

Improper cleaning may result in equipment damage.

- Only use recommended cleaning agents and tools.
- Never use sharp objects for cleaning.

- ▶ Clean the front screen at regular intervals and in the event of contamination using a lint-free lens cloth (part no. 4003353) and plastic cleaning agent (part no. 5600006). The cleaning interval essentially depends on the ambient conditions.

11.2 Maintenance plan

During operation, the device works maintenance-free.

Depending on the assignment location, the following preventive maintenance tasks may be required for the device at regular intervals:

Table 7: Maintenance plan

Maintenance work	Interval	To be carried out by
Check device and connecting cables for damage at regular intervals.	Depends on ambient conditions and climate.	Specialist
Clean housing and viewing window.	Depends on ambient conditions and climate.	Specialist
Check the screw connections and plug connectors.	Depends on the place of use, ambient conditions or operating requirements. Recommended: At least every 6 months.	Specialist

12 Troubleshooting

12.1 General faults, warnings, and errors

Possible faults and corrective actions are described in the table below for troubleshooting. In the case of faults that cannot be rectified using the information below, please contact SICK Service. To find your agency, see the final page of this document.



NOTE

Before calling, make a note of all type label data such as type code, serial number, etc., to ensure faster processing.

General faults are subdivided into warnings and errors. Current measured values continue being output when there are warnings; measurement is no longer possible when there are faults.

Question/Problem	Possible causes	Troubleshooting
The device is not displaying a measurement.	<ul style="list-style-type: none"> • Laser of the device not activated • Laser spot not aimed at object • Object outside the measuring range • Receiver element of the device not receiving sufficient light 	Advanced application settings <ul style="list-style-type: none"> • Check whether the laser of the device is activated. • Check whether the laser spot is aimed at the object. • Make sure that the object is within the measuring range of the device. • Check the light distribution curve in SOPAS ET. This function is only available in the Advanced user level. The light distribution curve shows whether the receiver element of the device is receiving light. In this case, the light distribution curve normally displays a maximum within the area shown. This graphic visualizes the light reflectance on the receiver element.
The display shows a warning triangle in the top right. Measurement not possible.	<ul style="list-style-type: none"> • Light path obscured • Device not in measuring range • Specular surfaces 	<ul style="list-style-type: none"> • Make sure that the light path is clear. • Make sure that the device is in the measuring range. • Check the surface characteristics.

12.2 Detecting and displaying errors

In addition to measurement errors (see ["Action in case of incorrect measurements", page 38](#)), the device can also detect and display other errors. The errors are outputted via the display, SOPAS ET or IO-Link.

Error memory

The device has an error memory where its internal error states are recorded. The last error to have occurred is always saved. The content of the error memory is retained when the device is switched off and when the **Reset > Factory settings** function is used.

Possible errors

Table 8: Explanation of the error codes

Error code	SOPAS ET hex code / device status	Meaning	Troubleshooting
-	- / No signal	No measurement possible	<ul style="list-style-type: none"> • Check the measuring range. • Increase the cycle time setting. • Decrease the distance to the object. <p>If the error cannot be rectified, contact SICK Service.</p>
-	- / Laser switched off	Laser is deactivated	Turn laser on.
Temperature error	0x50 / Temperature error 0x10 / Temperature warning	Operating temperature undershot or exceeded	Check the ambient temperature and raise or lower it if necessary.
Laser error	0x11 / Laser warning 0x60 / Laser error 1 0x61 / Laser error 2 0x62 / Laser error 3	Laser error	Contact SICK Service.
Internal error	0x80 / Internal error 1 0x81 / Internal error 2 0x82 / Internal error 3 0x83 / Internal error 4	Operating fault	Check the electrical environment and improve it, if necessary (stability, voltage supply, EMC influences). If the error cannot be rectified, contact SICK Service.

If a different message is output, contact Sick Service.

12.3 Information for service cases

You should collect and write down the following device information ahead of time if you need to contact SICK Service:

- Information about the firmware version
- Information about the hardware
- Information about operating hours

This information can be accessed via SOPASair.

12.4 Returns

- ▶ Do not dispatch devices to the SICK Service department without consultation.
- ▶ The device must be sent in the original packaging or an equivalent padded packaging.



NOTE

To enable efficient processing and allow us to determine the cause quickly, please include the following when making a return:

- Details of the contact person
- Description of the application
- Description of the fault that occurred

12.5 Repairs

Repair work on the device may only be performed by qualified and authorized personnel from SICK AG. Interruptions or modifications to the device by the customer will invalidate any warranty claims against SICK AG.

12.6 Disposal



CAUTION

Risk of injury due to hot device surface.

The surface of the device can become hot during operation.

- Before commencing disassembly, switch off the device and allow it to cool down as necessary.
-

If a device can no longer be used, dispose of it in an environmentally friendly manner in accordance with the applicable country-specific waste disposal regulations. Do not dispose of the product along with household waste.



NOTICE

Danger to the environment due to improper disposal of the device.

Disposing of devices improperly may cause damage to the environment.

Therefore, observe the following information:

- Always observe the national regulations on environmental protection.
 - Separate the recyclable materials by type and place them in recycling containers.
-

13 Technical data



NOTE

The relevant online data sheet for your product, including technical data, dimensional drawing, and connection diagrams can be downloaded, saved, and printed from the Internet:

- www.sick.com/OD1000

Please note: This documentation may contain further technical data.

13.1 Mechanics/electronics

Table 9: Technical data for mechanics/electronics

Supply voltage U_V	DC 18 V ... 30 V ¹⁾
Residual ripple	$\leq 5 V_{SS}$ ²⁾
Power consumption	$\leq 2.5 W$ ³⁾
Warm-up time	< 10 min
Housing material	Zinc die cast acrylic glass (PMMA), with scratch-proof coating
Connection type	20 cm cable with M12 male connector, 5-pin
Status indicators	OLED display, 3 status LEDs
Operating elements	4 pushbuttons
Weight	280 g
Dimensions	see "Setup and dimensions", page 14
Enclosure rating	IP 65, IP 67
Protection class	III in accordance with EN 50178
Electrical safety	IEC 61010-1 AMD 1:2016-12 UL 61010-1:2012/R:2016-04

¹⁾ Limit values, reverse-polarity protected. Operation in short-circuit protected network: max. 8 A.

²⁾ Must not fall short of or exceed U_V tolerances.

³⁾ Without load, at +20 °C.

13.2 Performance

Table 10: Technical data for performance

Measuring range	200 mm ... 1,000 mm ¹⁾
Resolution	50 μm ²⁾
Repeatability	0.4 mm ^{2), 3)}
Linearity	$\pm 1.5 mm$ ^{2), 4)}
Response time	1.5 ms ⁵⁾
Measuring frequency	$\leq 3 kHz$
Output time	$\geq 0.33 ms$
Light sender	Laser, visible red light Wavelength: 655 nm Maximum pulse power: 0.78 mW Maximum average power: 0.39 mW Maximum pulse duration: 1.8 ms
Laser class	Laser class 1 according to EN/IEC 60825-1:2014. Complies with 21 CFR 1040.10 and 1040.11 except for the listed tolerances in the document "Laser Notice No. 50" of June 24, 2007.

Typical light spot size	1.5 mm x 1.5 mm
Additional function	Adjustable averaging or median filter, switching modes: distance to object (DtO), window or ObSB (object between sensor (device) and background), teachable digital output, invertible digital output, teachable analog output, invertible analog output, switchable analog output mA/V, multifunctional input: laser off / external teach-in / deactivated, display switch-off, user interface lock, display can be rotated by 180°, alarm function, edge height change, time functions (ON/OFF delay, 1-shot)

- 1) 6% ... 90% reflectance; with standard settings.
- 2) 90% reflectance (white), at constant ambient conditions.
- 3) Statistical error 3 σ .
- 4) Observe min. warm-up time of 10 minutes.
- 5) With measuring frequency of 3 kHz, target change white 90%/white 90%.

Linearity

Typical linearity deviation in mm (inch)

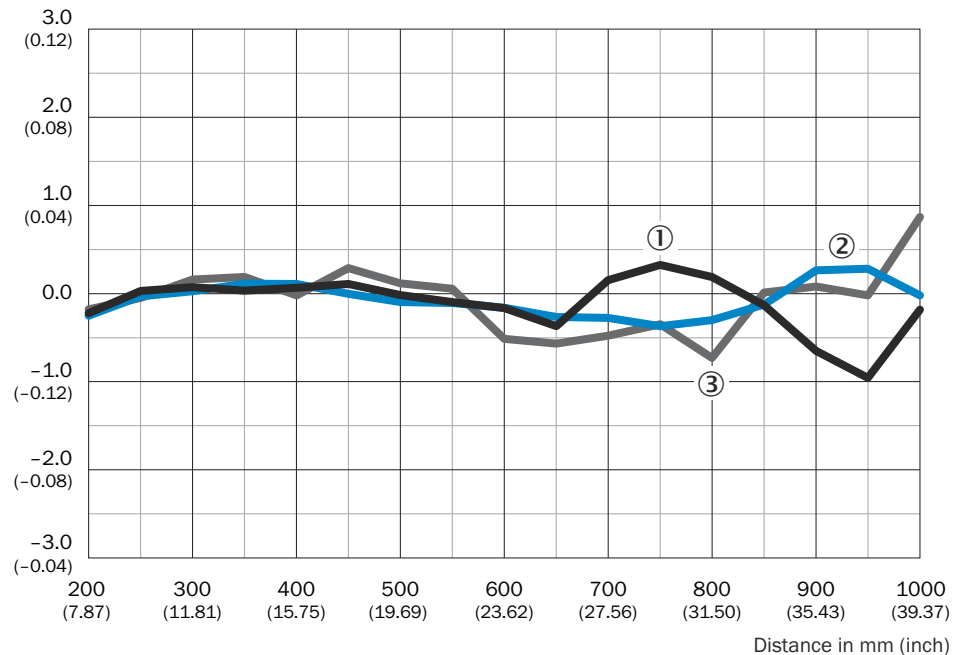

- ① Black 6 % remission
- ② White 90 % remission
- ③ Stainless steel

Figure 23: Linearity diagram

- ① Typical linearity deviation in mm (inch)
- ② Black, 6% remission
- ③ White, 90% remission
- ④ Stainless steel
- ⑤ Distance in mm (inch)

13.3 Interfaces

Table 11: Technical data for interfaces

Analog output	1x 4 mA ... 20 mA (< 600 Ω) / 1 x 0 V ... 10 V (> 20 k Ω) Resolution: 16-bit
digital output	2 x push-pull ¹⁾ , IO-Link

Multifunctional input (In1 input)	1 x ²⁾
IO-Link	Function: Process data, configuration, diagnostics, data storage Data transmission rate: 230.4 kBit/s (COM3) / 38.4 kBit/s (COM2) Protocol: V 1.1 / V 1.0

- 1) PNP: HIGH = $U_V - (< 3 V)$ / LOW = $< 3 V$; NPN: HIGH = $< 3 V$ / LOW = U_V .
2) Can be used as laser off, external teach-in, or deactivated.

13.4 Ambient data

Table 12: Ambient data

Ambient operating temperature	-10 °C ... +50 °C ¹⁾
Storage temperature	-20 °C ... +60 °C
Temperature drift	0.15 mm/K
Typ. ambient light immunity	Artificial light: $\leq 3,000 \text{ lx}$ ²⁾ Sunlight: $\leq 10,000 \text{ lx}$
Vibration resistance	EN 60068-2-6 / EN 60068-2-64
Shock resistance	EN 60068-2-27

- 1) At $U_V = 24 V$.
2) With constant object movement in the measuring range.

14 Accessories



NOTE

Accessories and where applicable mounting information can be found online at:

- www.sick.com/OD1000
-

15 Annex

15.1 EU declaration of conformity / Certificates

The EU declaration of conformity and other certificates can be downloaded from the Internet at:

- www.sick.com/OD1000

15.2 Licenses

SICK uses open source software which is published by the rights holders under a free license. Among others, the following license types are used: GNU General Public License (GPL version 2, GPL version 3), GNU Lesser General Public License (LGPL), MIT license, zlib license and licenses derived from the BSD license.

This program is provided for general use without warranty of any kind. This warranty disclaimer also extends to the implicit assurance of marketability or suitability of the program for a particular purpose.

More details can be found in the GNU General Public License. View the complete license texts here: www.sick.com/licensetexts. Printed copies of the license texts are also available on request.

Australia

Phone +61 (3) 9457 0600
1800 33 48 02 – tollfree
E-Mail sales@sick.com.au

Austria

Phone +43 (0) 2236 62288-0
E-Mail office@sick.at

Belgium/Luxembourg

Phone +32 (0) 2 466 55 66
E-Mail info@sick.be

Brazil

Phone +55 11 3215-4900
E-Mail comercial@sick.com.br

Canada

Phone +1 905.771.1444
E-Mail cs.canada@sick.com

Czech Republic

Phone +420 234 719 500
E-Mail sick@sick.cz

Chile

Phone +56 (2) 2274 7430
E-Mail chile@sick.com

China

Phone +86 20 2882 3600
E-Mail info.china@sick.net.cn

Denmark

Phone +45 45 82 64 00
E-Mail sick@sick.dk

Finland

Phone +358-9-25 15 800
E-Mail sick@sick.fi

France

Phone +33 1 64 62 35 00
E-Mail info@sick.fr

Germany

Phone +49 (0) 2 11 53 010
E-Mail info@sick.de

Greece

Phone +30 210 6825100
E-Mail office@sick.com.gr

Hong Kong

Phone +852 2153 6300
E-Mail ghk@sick.com.hk

Hungary

Phone +36 1 371 2680
E-Mail ertesites@sick.hu

India

Phone +91-22-6119 8900
E-Mail info@sick-india.com

Israel

Phone +972 97110 11
E-Mail info@sick-sensors.com

Italy

Phone +39 02 27 43 41
E-Mail info@sick.it

Japan

Phone +81 3 5309 2112
E-Mail support@sick.jp

Malaysia

Phone +603-8080 7425
E-Mail enquiry.my@sick.com

Mexico

Phone +52 (472) 748 9451
E-Mail mexico@sick.com

Netherlands

Phone +31 (0) 30 229 25 44
E-Mail info@sick.nl

New Zealand

Phone +64 9 415 0459
0800 222 278 – tollfree
E-Mail sales@sick.co.nz

Norway

Phone +47 67 81 50 00
E-Mail sick@sick.no

Poland

Phone +48 22 539 41 00
E-Mail info@sick.pl

Romania

Phone +40 356-17 11 20
E-Mail office@sick.ro

Russia

Phone +7 495 283 09 90
E-Mail info@sick.ru

Singapore

Phone +65 6744 3732
E-Mail sales.gsg@sick.com

Slovakia

Phone +421 482 901 201
E-Mail mail@sick-sk.sk

Slovenia

Phone +386 591 78849
E-Mail office@sick.si

South Africa

Phone +27 10 060 0550
E-Mail info@sickautomation.co.za

South Korea

Phone +82 2 786 6321/4
E-Mail infokorea@sick.com

Spain

Phone +34 93 480 31 00
E-Mail info@sick.es

Sweden

Phone +46 10 110 10 00
E-Mail info@sick.se

Switzerland

Phone +41 41 619 29 39
E-Mail contact@sick.ch

Taiwan

Phone +886-2-2375-6288
E-Mail sales@sick.com.tw

Thailand

Phone +66 2 645 0009
E-Mail marcom.th@sick.com

Turkey

Phone +90 (216) 528 50 00
E-Mail info@sick.com.tr

United Arab Emirates

Phone +971 (0) 4 88 65 878
E-Mail contact@sick.ae

United Kingdom

Phone +44 (0)17278 31121
E-Mail info@sick.co.uk

USA

Phone +1 800.325.7425
E-Mail info@sick.com

Vietnam

Phone +65 6744 3732
E-Mail sales.gsg@sick.com

Detailed addresses and further locations at www.sick.com