

EuroFID Industrial Enclosure

Closed Enclosure for EuroFID Analyzers

Installation · Commissioning · Operating Information

SICK
Sensor Intelligence.

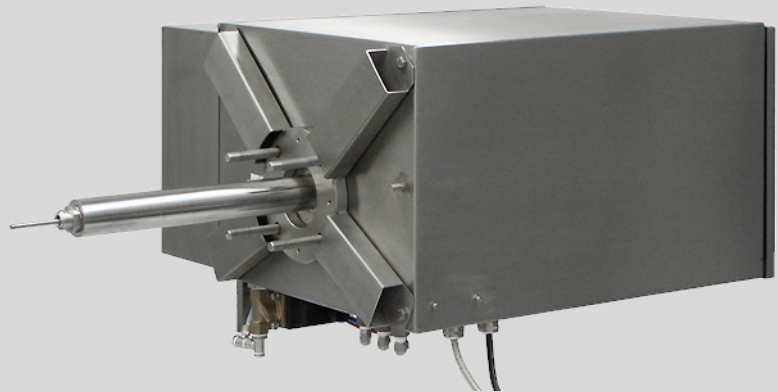

Described product

Product name: EuroFID Industrial Enclosure

Manufacturer

SICK AG

Erwin-Sick-Str. 1 · D-79183 Waldkirch · Germany

Phone: +49 7641 469-0

Fax: +49 7641 469-1149

E-mail: info.pa@sick.de

Production Location

SICK AG

Poppenbütteler Bogen 9b, D-22399 Hamburg, Germany

Legal information

This work is protected by copyright. All rights derived from the copyright shall be reserved for SICK AG. Reproduction of this document or parts of this document is only permissible within the limits of the legal determination of Copyright Law.

Any modification, shortening or translation of this document is prohibited without the express written permission of SICK AG.

The trademarks stated in this document are the property of their respective owner.

© SICK AG. All rights reserved.

Original document

This document is an original document of SICK AG.



Contents

1	About this document.....	5
1.1	Scope of application	5
1.2	Additional documents	5
2	For your safety.....	6
2.1	Main installation information	6
2.2	Main operating information	6
2.3	Intended use	6
2.3.1	Purpose	6
2.3.2	Installation location	6
2.3.3	Application limitations	7
2.4	Responsibility of user.....	7
3	Product description	8
3.1	Product features	8
3.2	Product variants	8
3.2.1	Alternative versions	8
3.2.2	Options (additional equipment)	8
3.3	Accessories	8
3.4	Delivery state.....	9
3.5	Lifting points on the EuroFID analyzer	9
4	Installation.....	10
4.1	Selecting the sample gas sampling point.....	10
4.2	Fitting the assembly flange.....	10
4.3	Fitting the enclosure	10
4.4	Connecting inside the enclosure	12
4.5	Feeding operating gases.....	13
4.6	Connecting electrical connections	13
5	Commissioning	14
5.1	Commissioning procedure	14
6	Decommissioning.....	15
6.0.1	Preparations for decommissioning.....	15
6.0.2	Switch-off procedure.....	15

7	Special measures for maintenance.....	16
8	Technical data.....	17
8.1	Dimensions	17
8.2	Enclosure specifications	18
8.3	Ambient conditions	18
8.4	Main power supply	18
8.5	Type plate.....	18
8.6	Operating gases.....	19
8.7	Accessories	20
8.7.1	Mounting connection	20
8.7.2	Cables	20
8.7.3	Plug-in connectors for control unit	20
8.7.4	Terminal modules for the control unit.....	20

1 About this document

1.1 Scope of application

These Operating Instructions are valid as Addendum to the “EuroFID Operating Instructions”.

- ▶ Also observe the Operating Instructions of the EuroFID Gas Analyzer.

1.2 Additional documents

Only for the product version with active enclosure cooling (option):

- ▶ Also observe the Operating Instructions of the cooling unit.

2 For your safety

2.1 Main installation information

Fragile sampling probe



- ▶ Observe the permissible lifting points (see “Lifting points on the EuroFID analyzer”, page 9).
 - ▶ Do not use the sampling probe as a lifting point.
 - ▶ Do not subject the sampling probe to mechanical loads. Otherwise the built-in glass vacuum tube can break.
-

Throughflow limit for hydrogen

- ▶ Install a throughflow limiter in the H₂ gas feed to the device that limits the H₂ volume flow to the device to 200 ml/min (12 l/h).



A throughflow limiter is not included in the scope of delivery of the device.

2.2 Main operating information

Commissioning

- ▶ Check the requirements for commissioning before the actual commissioning:
 - Industrial enclosure is shut tight
 - Instrument air and fuel gas supply both available
 - Mains switch of the EuroFID operating unit is switched on

Operation

- ▶ Ensure free ventilation on the right enclosure side.

2.3 Intended use

2.3.1 Purpose

- The EuroFID Industrial Enclosure is a robust enclosure for an EuroFID analyzer for use in areas partly protected against climate conditions.
- The EuroFID Industrial Enclosure, the EuroFID analyzer and the built-in terminal box comprise the analyzer unit type “EuroFID Industrial Enclosure”.



Further information see “Product description”, page 8.

2.3.2 Installation location

- The analyzer unit type “EuroFID Industrial Enclosure” can be used indoors and outdoors.
 - The installation location must be at least “partly protected against climate conditions” (EN 60721-3-3).
 - Allowable ambient temperature, see “Ambient conditions”, page 18.
-



Unallowed ambient conditions can impair the device function and measuring precision.



The EuroFID Industrial Enclosure is not suitable for use in potentially explosive atmospheres.

2.3.3 Application limitations

- The internal process gas pressure measured must not deviate from the ambient pressure (atmospheric air pressure) by more than ± 50 hPa (± 50 mbar).
- The EuroFID Industrial Enclosure must be installed at a location virtually free from vibrations.



Allowable vibration load, see “Ambient conditions”, page 18

2.4 Responsibility of user

Designated users

These Operating Instructions are intended for skilled persons familiar with the following:

- Installation (setting up/assembly)
- Commissioning
- Operating and monitoring during operation
- Maintenance/service

Correct use

- ▶ Use the device only as specified in these Operating Instructions. The manufacturer assumes no responsibility for any other use.
- ▶ Carry out the specified maintenance work.
- ▶ Do not remove, add or modify any components to or on the device unless described and specified in the official manufacturer information. Otherwise
 - the device may become dangerous
 - any warranty by the manufacturer becomes void.

Special local conditions

- ▶ In addition to these Operating Instructions, observe all local laws, technical regulations and company-internal operating directives applicable at the installation location of the device.

Retention of documents

- ▶ Keep these Operating Instructions available for reference.
- ▶ Pass these Operating Instructions on to a new owner.

3 Product description

3.1 Product features

- Permanent purging of enclosure interior with instrument air.
- Active cooling of enclosure interior (variants, see “Alternative versions”).
- Automatic frost protection heating.



An EuroFID gas analyzer comprises three main device modules:

- *EuroFID analyzer*: Contains the physical measuring system and basic electronics
- *Control unit*: Contains the electronic control and provides the device displays and operating functions
- *Terminal box*: Connects EuroFID analyzer and control unit.

The EuroFID Industrial Enclosure contains the EuroFID analyzer and the terminal box. The control unit is installed separately.



For a detailed description of the EuroFID device components, see “EuroFID Operating Instructions”.

3.2 Product variants

3.2.1 Alternative versions

Feature	Alternative versions
Enclosure interior cooling:	<ul style="list-style-type: none"> - Active enclosure ventilation (fan) - Active enclosure cooling (cooling unit)
Flange:	<ul style="list-style-type: none"> - DIN Standard (EU Version) - ANSI Standard (US Version)
Power voltage:	<ul style="list-style-type: none"> - 230 V AC - 115 V AC

3.2.2 Options (additional equipment)

Process gas flow barrier	Prevents process gas (sample gas) flowing out of the open filter during maintenance work on the sample gas filter (suitable for process gas pressures from 0 ... 50 mbar against ambient pressure)
--------------------------	----------------------------------------------------------------------------------------------------------------------------------------------------------------------------------------------------

3.3 Accessories

For mechanical installation

- Mounting connections in various lengths (see “Mounting connection”, page 20)

For electrical installation

- Plug-in connector sets for the operating unit
- Terminal module Version 1.0
 - Leads the connections of the “Analog and Digital I/O” plug-in connector to screw terminals.
 - Passive module; needs no voltage supply
 - No separation of signal lines.
- Terminal module Version 2.0
 - Active module with relay for electric isolation of the signal lines.
 - Requires an own (separate) 24 V DC voltage supply.
 - The relay contacts close should the voltage supply fail.
- Connection cable to connect a terminal module to the operating unit

- Cable material



Part Nos. of accessory parts, see “Accessories”, page 20.

3.4 Delivery state

The industrial enclosure and the EuroFID analyzer are delivered separately to simplify transport and assembly.



- ▶ Observe the safety notes on the lifting points (see “Lifting points on the EuroFID analyzer”, page 9).



Assembly, see “Fitting the enclosure”, page 10.

3.5 Lifting points on the EuroFID analyzer

- ▶ Always handle and store the EuroFID analyzer and a complete analyzer unit type “EuroFID Industrial Enclosure” so that the sampling probe is not subjected to any loads.



NOTE:

The sampling probe contains a glass vacuum tube.

- ▶ Do not subject the sampling probe to mechanical loads.
- ▶ Do not use the sampling probe as a lifting point.

Otherwise the vacuum tube can break.

If the vacuum tube breaks, condensate can form in the sampling probe during operation. Condensate in the sample gas path can damage the measuring system or render it useless.

Fig. 1: Lifting points on the EuroFID analyzer

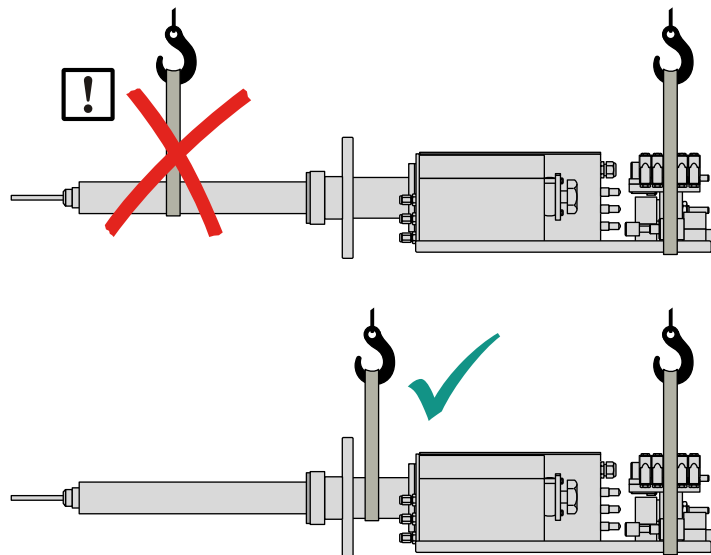

4 Installation

4.1 Selecting the sample gas sampling point

- ▶ Before feeding sample gas, check whether the sample gas can chemically attack the materials of parts carrying the sample gas (materials, see “EuroFID Operating Instructions”).
- ▶ Ensure,
 - the gas pressure at the sampling point (process gas pressure/pressure at sample gas inlet) does not deviate from ambient pressure by more than ± 50 hPa;
 - the opening at the tip of the sampling probe cannot clog, e.g. through flue dust;
 - the sample gas sampling probe has no mechanical load (see safety information in “Fitting the enclosure”).
- ▶ Make sure the sample gas is mixed homogeneously at the sampling point. Make tests to determine the most suitable sampling point (examine the line cross-section) when strands can be expected in the gas flow,

4.2 Fitting the assembly flange

- ▶ Fit a suitable mounting connection at the desired sampling point to which the EuroFID Industrial Enclosure can be fastened (see “Mounting connection”, page 20).
 - Take the space requirements for fitting and opening the front door into account (see “Dimensions”, page 17).
 - Check whether the flange must be supported to be able to carry the device load. If necessary, provide mechanical support for the flange.



Load (weight) and flange specification, see “Enclosure specifications”, page 18.

4.3 Fitting the enclosure

- 1 Fasten the empty industrial enclosure on the mounting connection (see Fig. 2).
 - ▶ Gas connections pointing downwards.
 - ▶ Insert a flat seal between the industrial enclosure and mounting connection.

Fig. 2: Fitting the enclosure on the mounting connection

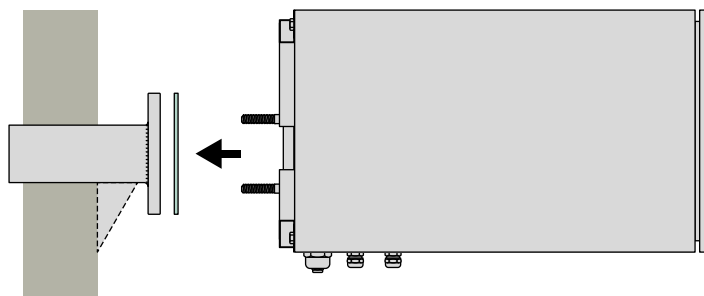

- 2 Ensure the sealing collar (silicone foam sealing ring) is fitted on the sample probe of the EuroFID analyzer (see Fig. 3).

Fig. 3: Sealing collar on the sampling probe

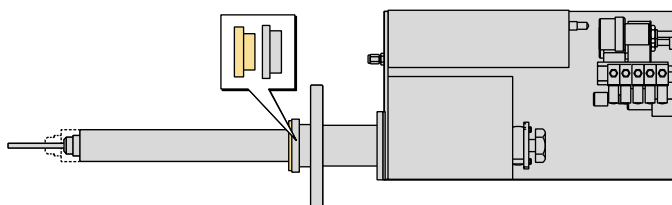

3 Fit the EuroFID analyzer in the EuroFID Industrial Enclosure (position it on the rails, see Fig. 4, page 11).

- ▶ Guide the sampling probe carefully into the enclosure through the flange opening.
- ▶ Position the base frame on the rails and push in to the stop.
- ▶ Lead the sample gas outlet hose downwards out of the enclosure (outlet).



▶ Do not subject the sampling probe to mechanical loads. Observe the safety notes on the lifting points (see “Lifting points on the EuroFID analyzer”, page 9). Otherwise the built-in glass vacuum tube can break.

Fig. 4: Fitting the EuroFID analyzer

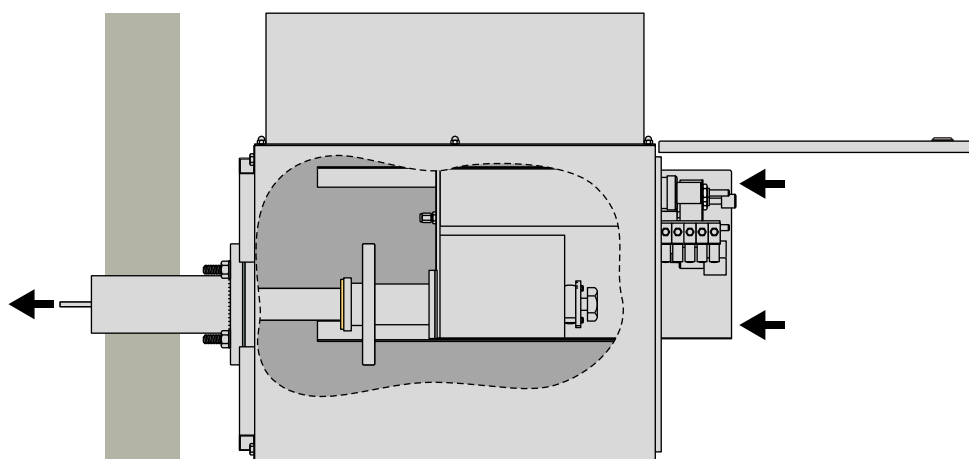

4 Fasten the EuroFID analyzer (see Fig. 5):

- ▶ Place the clamping bar onto the rails behind the base frame.
- ▶ Press the clamping bar and base frame firmly in flange direction so that the silicone foam seal is compressed.
- ▶ Fasten the clamping bar in this position (tighten clamping screw).

Fig. 5: Fastening the EuroFID analyzer

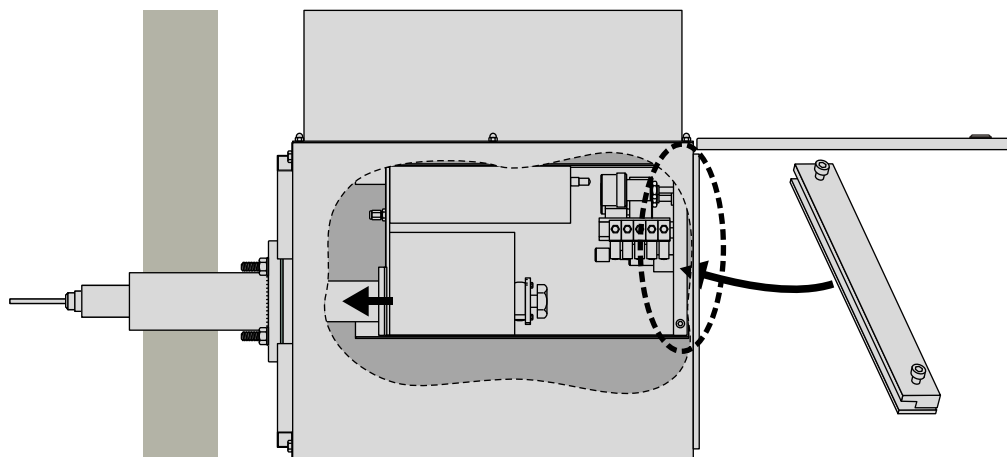

4.4 Connecting inside the enclosure

- ▶ *Connect the three gas lines inside:* Connect the gas line couplings according to the color markings (red/blue/white). Make sure connections are gas tight and locked properly.
- ▶ *Lay the gas outlet:* Lead the sample gas outlet hose (exhaust/outlet) downwards out of the industrial enclosure.
- ▶ *Connect the electricity:* Connect the connection cable of the EuroFID analyzer to the counterpiece inside the enclosure.

Fig. 6: Connection diagram

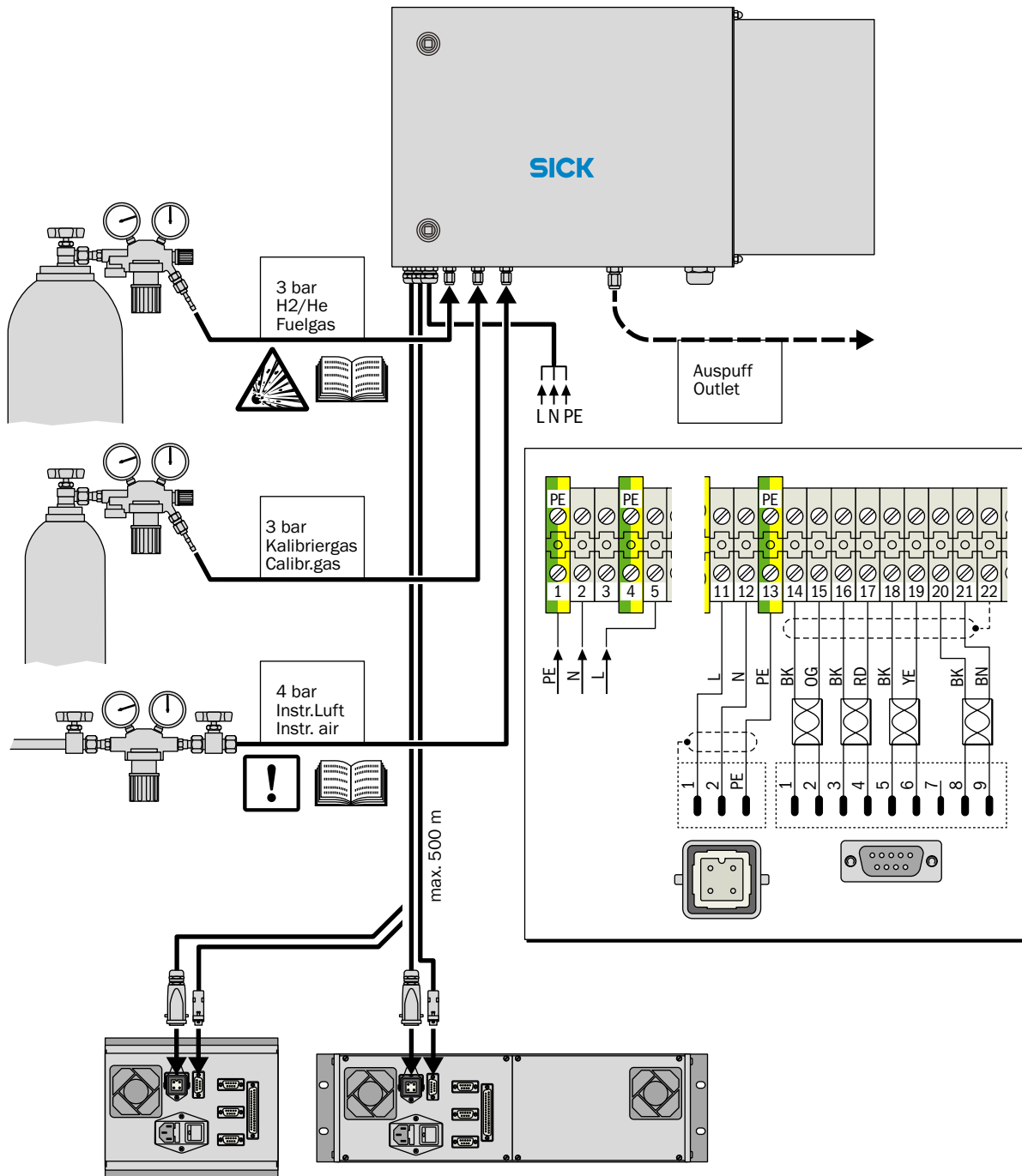

4.5 Feeding operating gases

- ▶ Observe the specifications for operating gases – see [“Operating gases”, page 19](#).
- ▶ Establish feeding of operating gases (instrument air, fuel gas, calibration gas) as described in the “EuroFID Operating Instructions” using the gas connections of the EuroFID Industrial Enclosure (see [“Connection diagram”, page 12](#)).
The instrument air is also used in the EuroFID Industrial Enclosure for permanent purging of the enclosure interior.
- ▶ Install a device in the fuel gas feed that ensures the H₂ volume flow to the EuroFID Industrial Enclosure cannot be more than 200 ml/min (12 l/h).



Realization options for limiting throughflow:

- Automatic throughflow limiter
- Combination of pressure regulator and control valve (throttle valve) with suitable settings
- Leak monitoring unit with automatic gas feed shut-off



Gas connections layout, see [“Enclosure specifications”, page 18](#).

4.6 Connecting electrical connections

Install the power connection

- ▶ Connect the main power supply to the connection terminals in the enclosure (see [“Connection diagram”, page 12](#)).

Connect the EuroFID control unit

- ▶ Cable connections (wiring), see [“Connection diagram”, page 12](#).
- ▶ Approved cable material, see [“Cables”, page 20](#).

5 Commissioning

5.1 Commissioning procedure

- 1 *Check leak tightness:*
 - *Inside:* The silicone foam seal of the analyzer is pressed firmly against the inner wall.
 - *Outside:* The enclosure door is shut tight.
- 2 *Check readiness for operation:*
 - Instrument air and fuel gas feed are ensured.
 - Mains switch of the EuroFID control unit is switched on.
- 3 *Switch on:* Activate the power voltage supply for the EuroFID Industrial Enclosure at an external location (*example:* Switch the main switch of the control cabinet on).
- 4 Wait until the EuroFID is ready for operation (observe status indicator of control unit).

6 Decommissioning

6.0.1 Preparations for decommissioning

Secure connected systems

- ▶ Inform any connected stations.
- ▶ Secure/deactivate connected devices (e.g. process control).
- ▶ Deactivate connected reporting units (alarm indicators, status indicators).

Protection against condensation



NOTE:

The sensor block of the measuring system is heated to prevent condensation in the internal measuring system. Condensation can occur in the sensor block when it cools down when the EuroFID is being decommissioned. This must not occur: Liquids can render the measuring system unusable.

- ▶ Before every decommissioning, purge the internal sample gas path with a “dry” neutral gas.
-
- ▶ Use the “Zero point test” function to feed instrument air (= zero gas) into the measuring system (see EuroFID Operating Instructions).

6.0.2 Switch-off procedure

- 1 Carry out preparations (see “Preparations for decommissioning”).
- 2 Close off the calibration gas supply (when present).
- 3 Close off the fuel gas supply (external valve).
- » The FID flame goes out. The EuroFID measuring system is purged with instrument air (see “Preparations for decommissioning” “Protection against condensation”).
- 4 Deactivate the H₂ leakage monitoring unit (when present).
- 5 Close off the instrument air supply.
- 6 Switch the EuroFID control unit off:
 - ▶ *Either:* Interrupt the main power supply (e.g., system main switch).
 - ▶ *Or:* Switch the main power switch at the back of the control unit off.
- 7 Interrupt the main power supply for the EuroFID Industrial Enclosure (*example:* Switch the main switch of the control cabinet off).



CAUTION: Hot components inside the enclosure

The sensor block and sample gas filter are hot when in operation (≈ 200 °C).

Before doing maintenance work inside the enclosure:

- ▶ *Either:* Let components cool down (recommended).
- ▶ *Or:* Wear protective gloves.

7 Special measures for maintenance

Only applicable for versions with active enclosure cooling

- ▶ Carry out the checks and maintenance measures for the cooling unit regularly as prescribed in the Operating Instructions of the cooling unit.

8 Technical data

8.1 Dimensions

Fig. 7: Dimensions

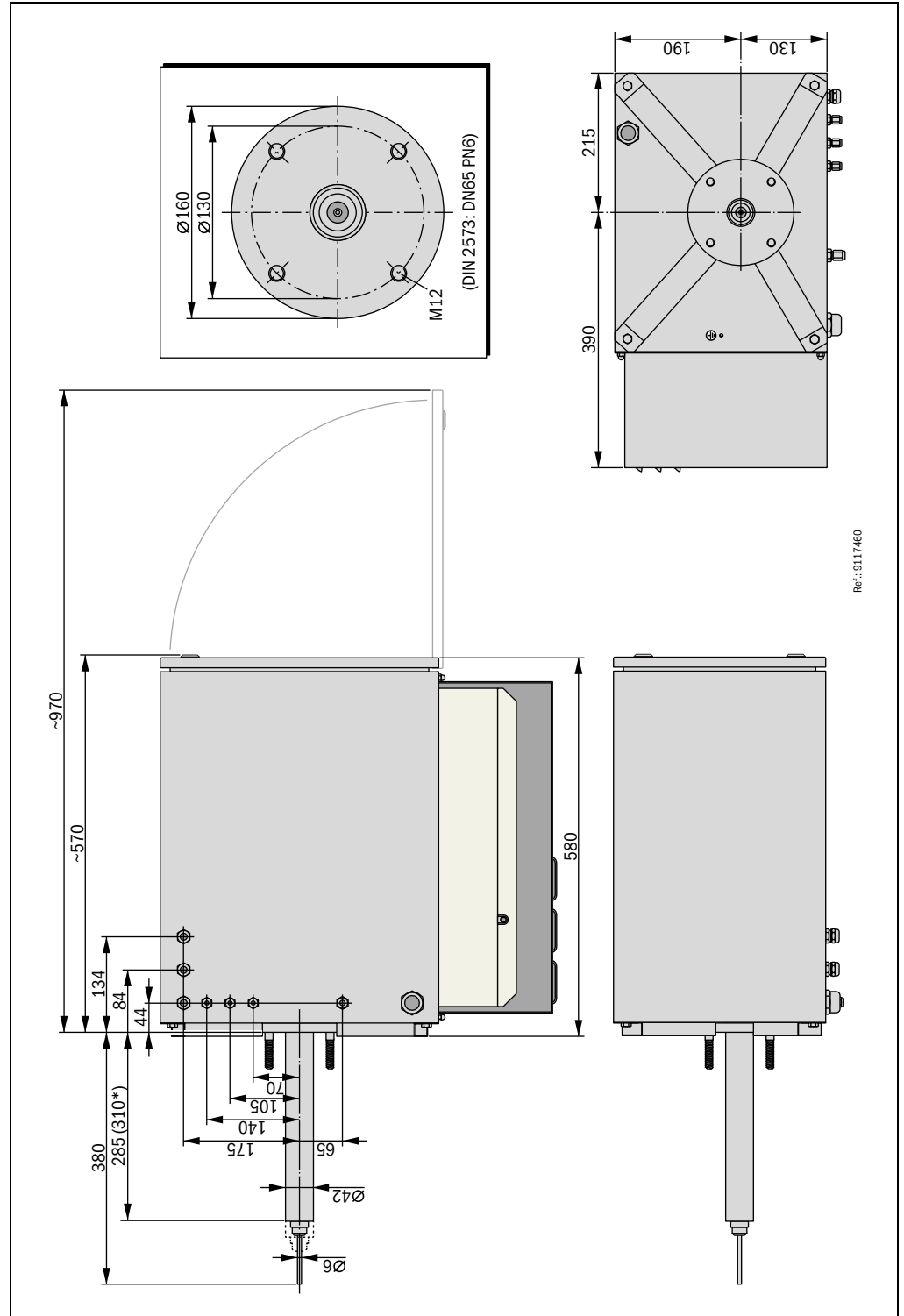

8.2 Enclosure specifications

Degree of protection:	IP 54
Dimensions:	see "Dimensions", page 17
Weight	
- Version with fan:	35 kg
- Version with cooling unit:	48 kg
Gas connections:[1]	Clamping ring screw fitting for tube with outer diameter 6 mm

Table 1: Performance characteristics for the mains connection

[1] Instrument air, fuel gas, calibration gas.

Flange:

Version	Flange	Material	Threaded bolts
EU	EN 1092 DN65 / PN6	1.4571	M12
US	ANSI B16.5 150lb/sq.in. DN3"	1.4301	5/8" UNC

8.3 Ambient conditions

Environment conditions:	Partly protected against climate conditions (EN 60721-3-3)
Allowable ambient temperature	
- with active enclosure ventilation:	-20 ... +30 °C
- with active enclosure cooling:	-20 ... +50 °C
Allowable vibration load:	Max. 0.2 g (1.96 m/s ²) In frequency range 10 ... 150 Hz

8.4 Main power supply

Supply voltage:	230 or ^[1] 115 V AC ^[2] , + 10%/- 15%
Power frequency:	50 ... 60 Hz
Power input in operation ^[3]	
- with active enclosure ventilation:	Max. 430 W
- with active enclosure cooling:	Max. 680 W

Table 2: Performance characteristics for the mains connection

[1] Version, see "Type plate".

[2] Free of interference voltages.

[3] The built-in frost protection heating is only active for temperatures near freezing point.

8.5 Type plate

Fig. 8: Type plate

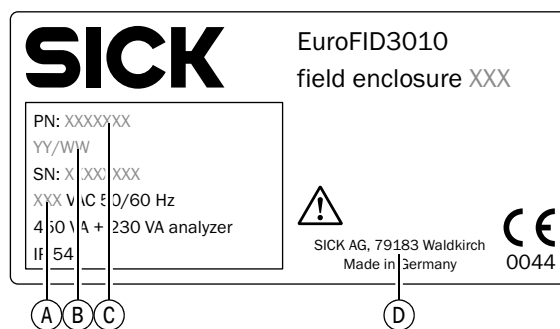

- A Power voltage^[1]
- B Date of manufacture (year/calendar week)
- C Identification number of product version ^[1]
- D Manufacturer

[1] see "Product variants", page 8.

8.6 Operating gases

Instrument air

Dew point:	At least 10 °C under lowest ambient temperature [1]
Allowable dust content:	≤ 1 mg/m ³ Particle size: Max. 1 µm
Allowable oil content:	≤ 0.1 mg/m ³
Allowable hydrocarbons content:	≤ 4 ppm or < 1% of measuring range (used)
Supply pressure:	400 kPa (4 bar)
Consumption:	Approx. 1.2 m ³ /h
Consumption	
- Ejector pump:	Approx. 400 l/h
- Enclosure purging:	Approx. 1800 l/h

[1] To prevent condensation in the lines.

Fuel gas

Material:	Pure hydrogen (H ₂ from pressure container)
Purity class	5.0
Allowable hydrocarbons content:	≤ 0.5 ppm
Supply pressure:	300 kPa (3 bar) ± 10 %
Consumption:	Approx. 1.8 l/h

Calibration gas

Material:	Mixture of synthetic (or cleaned accordingly) air and gaseous hydrocarbons (e.g. propane)
CH concentration:	Approx. 80% ^[1] of end value of measuring range used
Supply pressure:	300 kPa (3 bar) ± 10%
Consumption:	2 ... 3 l/min (120 ... 180 l/h) ^[2]

[1] Relative to the propane equivalent.

[2] Only during the calibration procedure.



When determining the lower explosion limit (LEL), 8000 ppm propane in synthetic air is usually used as calibration gas.

8.7 Accessories

8.7.1 Mounting connection

Fig. 9: Mounting connection for flange version "EU"

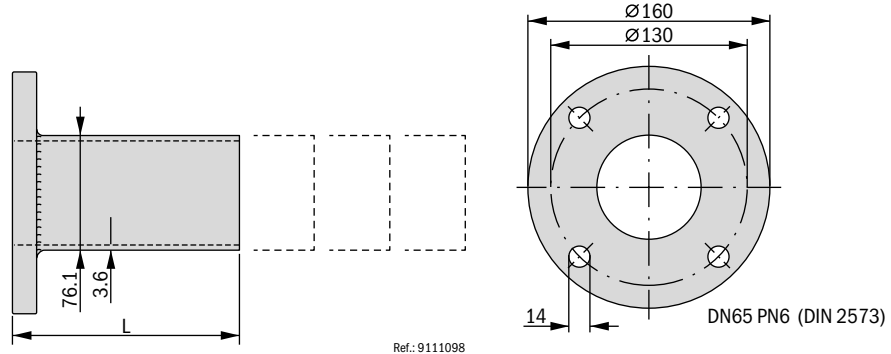

Flange version ^[1]	Component	Part No.
EU	Mounting connection L = 150 mm, 1.4571	2033623
	Mounting connection L = 200 mm, 1.4571	2033435
	Mounting connection L = 250 mm, 1.4571	2033436
	Mounting connection L = 300 mm, 1.4571	2033437
US	Mounting connection 3" L = 150 mm, 1.4571	2044037
	Mounting connection 3" L = 200 mm, 1.4571	2044039
	Mounting connection 3" L = 250 mm, 1.4571	2044040
	Mounting connection 3" L = 300 mm, 1.4571	2044041

[1] see "Main power supply", page 18.

8.7.2 Cables

Component	Part No.
3G1.5 Oelflex Classic 110 CY ^[1]	6029379
4P×0.34mm ² AWG22 twisted in pairs with shield LIYC2Y (TP) UL-style No. 2464/1061 ^[1]	6030048
5G1.5 Oelflex Classic 110 CY ^[1]	6030040
Terminal module-control unit connection cable ^[2] , with plug-in connectors, 5 m long	2028680

[1] Sold by meter; Specify required length when ordering.

[2] 37-pole D-Sub plug-in connector, "Analog and Digital I/O".

8.7.3 Plug-in connectors for control unit

Component	Part No.
Plug-in connector, Set 1 (connection material for EuroFID), comprising: - 9-pole D-Sub plug (for plug-in connector "Dataline") - 4-pole special plug (for plug-in connector "Analyzer Assembly") - Power cable socket CEE-22 (for control unit power connection)	2028690
Plug-in connector, Set 2 (connection material for EuroFID), comprising: - Contents as for plug-in connector SET 2028690 + in addition: - 25-pole D-Sub plug (for terminal module 2)	2032879

8.7.4 Terminal modules for the control unit

Component	Part No.
Terminal module 1 (passive, no separation of signal lines)	2028677
Terminal module 2 (active, with relay disconnection, requires 24 V DC supply voltage)	2028818

9 Index

A

Accessories	8
Alternative versions	8
Ambient conditions	
- Description	6
- Specifications	18
Application limitations	7
Assembly	10
Assembly flange	
- Accessories	20
- Installing	10
- Specification	18

C

Cable/cable material	20
Calibration gas	
- Feed, connecting	13
- Specifications	19
Commissioning	
- Measures during initial commissioning	14
Control unit, connecting	13

D

Decommissioning	
- Preparations	15
Degree of protection	18
Delivery state	9
Dimensions	17

E

Electrical installation	13
-------------------------------	----

F

Flange specification	18
Fuel gas	
- Feed, connecting	13
- Specifications	19
Function test (recommendation)	17
Function/purpose (general)	6

G

Gas connections	
- Feeding operating gases	13
- Version	18

I

Important information	
- Intended use	6
- Main installation information	6
- Most important operating information	6
Installation	
- Assembly flange, fitting	10
- Connecting electrical connections	13
- Connecting inside enclosure	12
- Connections (diagram)	12
- Feeding operating gases	13
- Fitting the enclosure	10
Installation location	6
Instrument air	
- Feed, connecting	13
- Specifications	19
Intended use	6
- Intended users	7
- User (target group)	7
Intended users	7

L

Lifting points	9
----------------------	---

M

Maintenance	16
- Function test	17
Mounting connection	20

O

Operating gases	
- Connections	13
- Specifications	19
Options	8

P

Plug-in connector	20
Power connection	
- Connecting, installing	13
- Technical data	18
Product description	8
- Product features	8
- Product variants	8
Protection against condensation	15
Purpose	6

S

Sample gas	
- Outlet (exhaust)	12
- Sampling point	10
Sampling point (sample gas)	10
Screw connections (gas connections)	18
Shielding (cable)	20
Shutdown	
- Protection against condensation	15
- Switch-off procedure	15
Start-up	
- Prerequisite	14
- Procedure	14
Switch-off procedure	15

T

Technical data	17
Terminal modules	20
Type plate	18

U

User	7
------------	---

V

Variants	8
----------------	---

W

Weight	18
--------------	----

Australia

Phone +61 3 9457 0600
1800 334 802 – tollfree
E-Mail sales@sick.com.au

Austria

Phone +43 22 36 62 28 8-0
E-Mail office@sick.at

Belgium/Luxembourg

Phone +32 2 466 55 66
E-Mail info@sick.be

Brazil

Phone +55 11 3215-4900
E-Mail marketing@sick.com.br

Canada

Phone +1 905 771 14 44
E-Mail information@sick.com

Czech Republic

Phone +420 2 57 91 18 50
E-Mail sick@sick.cz

Chile

Phone +56 2 2274 7430
E-Mail info@schadler.com

China

Phone +86 20 2882 3600
E-Mail info.china@sick.net.cn

Denmark

Phone +45 45 82 64 00
E-Mail sick@sick.dk

Finland

Phone +358-9-2515 800
E-Mail sick@sick.fi

France

Phone +33 1 64 62 35 00
E-Mail info@sick.fr

Germany

Phone +49 211 5301-301
E-Mail info@sick.de

Hong Kong

Phone +852 2153 6300
E-Mail ghk@sick.com.hk

Hungary

Phone +36 1 371 2680
E-Mail office@sick.hu

India

Phone +91 22 6119 8900
E-Mail info@sick-india.com

Israel

Phone +972 4 6881000
E-Mail info@sick-sensors.com

Italy

Phone +39 02 274341
E-Mail info@sick.it

Japan

Phone +81 3 5309 2112
E-Mail support@sick.jp

Malaysia

Phone +6 03 8080 7425
E-Mail enquiry.my@sick.com

Mexico

Phone +52 (472) 748 9451
E-Mail mario.garcia@sick.com

Netherlands

Phone +31 30 2044 000
E-Mail info@sick.nl

New Zealand

Phone +64 9 415 0459
0800 222 278 – tollfree
E-Mail sales@sick.co.nz

Norway

Phone +47 67 81 50 00
E-Mail sick@sick.no

Poland

Phone +48 22 539 41 00
E-Mail info@sick.pl

Romania

Phone +40 356 171 120
E-Mail office@sick.ro

Russia

Phone +7 495 775 05 30
E-Mail info@sick.ru

Singapore

Phone +65 6744 3732
E-Mail sales.gsg@sick.com

Slovakia

Phone +421 482 901201
E-Mail mail@sick-sk.sk

Slovenia

Phone +386 591 788 49
E-Mail office@sick.si

South Africa

Phone +27 11 472 3733
E-Mail info@sickautomation.co.za

South Korea

Phone +82 2 786 6321
E-Mail info@sickkorea.net

Spain

Phone +34 93 480 31 00
E-Mail info@sick.es

Sweden

Phone +46 10 110 10 00
E-Mail info@sick.se

Switzerland

Phone +41 41 619 29 39
E-Mail contact@sick.ch

Taiwan

Phone +886 2 2375-6288
E-Mail sales@sick.com.tw

Thailand

Phone +66 2645 0009
E-Mail Ronnie.Lim@sick.com

Turkey

Phone +90 216 528 50 00
E-Mail info@sick.com.tr

United Arab Emirates

Phone +971 4 88 65 878
E-Mail info@sick.ae

United Kingdom

Phone +44 1727 831121
E-Mail info@sick.co.uk

USA

Phone +1 800 325 7425
E-Mail info@sick.com

Vietnam

Phone +84 945452999
E-Mail Ngo.Duy.Linh@sick.com

Further locations at www.sick.com