

INSTALLATION & MAINTENANCE INSTRUCTIONS

DESCRIPTION / IDENTIFICATION

The ISQB1 series control valve is an electronic pressure regulator designed to precisely and proportionally control the pressure of gaseous media based on an electronic control signal.

The ISQB1 operates using two normally closed solenoid valves, a pressure sensor, and a control circuit. One valve is actuated to allow supply media into the system. The second valve is actuated to allow working media to vent through a threaded port to atmosphere. The pressure sensor provides feedback to the control circuit. The control circuit compares the pressure sensor feedback to the user supplied electronic command signal and actuates the appropriate valve until the two signals match.

The ISQB1 series can be teamed with a variety of air piloted pressure volume boosters for even greater flow.

PROPORTION-AIR, INC.
8250 N. 600 West
McCordsville, IN 46055

877.331.1738
info@proportionair.com



SPECIFICATIONS

ELECTRICAL

Unless specified by label on unit, consult factory with model and serial number for supply voltage specifications.

MECHANICAL

PRESSURE RANGES	Full Vacuum - 150 psig (29.9 in. HG (Vac) - 10.3 Bar)
OUTPUT PRESSURE†	0-100% of range
FLOW RATE	0.80 SCFM @ 80 PSIG (23 L/min @ 5.52 Bar)
Min CLOSED END VOLUME	1 in ³
PORT SIZE	1/8" NPT
FILTRATION RECOMMENDED	20 Micron (included)
LINEARITY/HYSTERESIS	<±0.4% F.S. BFSL
REPEATABILITY	<±0.2% F.S.
ACCURACY	<±0.5% F.S.

PHYSICAL

OPERATING TEMPERATURE	32-104°F (0-40°C) (T4)
WEIGHT	2.5 lbs. (1.1 Kg)
PROTECTION RATING	NEMA 4
HOUSING	Blue Anodized Aluminum

† Pressure ranges are customer specified. Output pressures other than 100% are available.

HAZARDOUS AREA CLASSIFICATION

The ISQB is rated Intrinsically Safe and is Factory Mutual approved for Class I, II & III, Division 1, Groups C, D, E, F & G

Entity Parameters:

V Max = 29 VDC
I Max = 150 MA
Ci = 0.26uF
Li = 0

Field Wiring Drawing: ISQB-96026-2

NOTES: End user must determine fitness and suitability of the ISQB1 control valve for their application. The ISQB requires the use of Intrinsically Safe Barriers.

WETTED MATERIALS

PARAMTERS	Port 1 (Pressure Port)	Port 2 (Reference Port)
COVERS	High Temperature Polyamide	High Temperature Polyamide
SUBSTRATE	Alumina Ceramic	Alumina Ceramic
ADHESIVES	Epoxy, RTV	Epoxy, RTV
ELECTRONIC COMPONENTS	Ceramic, Silicon	Silicon, Glass, Gold, Solder

Pneumatic Connections:

1. A typical 20 micron (minimum 40 micron) in-line filter is recommended on the inlet of the ISQB1.
2. Connect supply pressure to the "IN" INLET PORT (figure 1). See Table 1 for maximum supply pressure.
3. Connect the "OUT" OUTLET PORT (figure 1) to the device being controlled.
4. Media vents through exhaust port. If the media is hazardous (classified), the threaded exhaust port (figure 1) should be vented into a safe area.
5. Proceed with electrical connection.

**TABLE 1
RATED PRESSURE FOR ISQB1 VALVES**

For valves ordered with MAX. calibrated pressure of	Max. inlet pressure is
Vacuum up to 10 psig (0.69 bar)	Consult factory
10.1 up to 30 psig (0.70 up to 2 bar)	35 psig (2.4 bar)
31 up to 100 psig (2.1 up to 7 bar)	110 psig (7.6 bar)
101 up to 150 psig (7 up to 12 bar)	150 psig (12 bar)

Electrical Connections:

1. All intrinsically safe installation must conform to applicable Factory Mutual Code recommendations and the National Electric Code, as well as any applicable local codes or Fire Marshal directives. All intrinsically safe installations must be performed by personnel trained in the proper application of the above.
2. Ensure all power is off before making any electrical connections.
3. Figure 1 shows the location of the ISQB1 electrical connector and figure 2 shows the connector. Table 2 identifies each connection
4. Must be wired in accordance with the supplied field wiring drawing.

**TABLE 2
ISQB1 PIN DESIGNATORS**

PIN	FUNCTION
1	DC COMMON
2	COMMAND (-)
3	NC
4	COMMAND (+)
5	NC
6	POWER

Before you get started, please read these warnings:

- ◆ Examine the product. Ensure that you received what you ordered.
- ◆ Read this guide first before you start and save it for later use.
- ◆ All compressed air and power should be shut off before installing, removing or performing maintenance on this product.
- ◆ Installation and use of this product should be under the supervision and control of properly qualified personnel in order to avoid the risk of injury or death.
- ◆ Media vents through exhaust port. If the media is hazardous (classified), the exhaust port should be vented into a safe area.

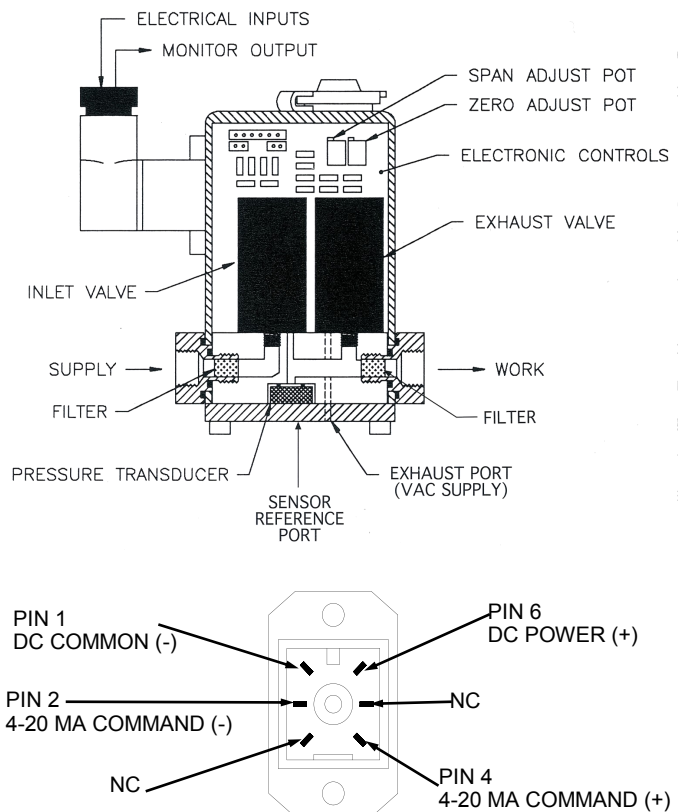
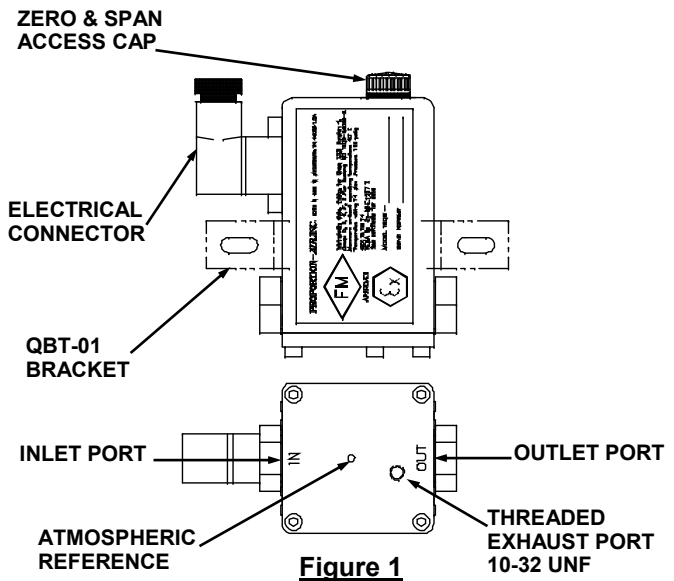
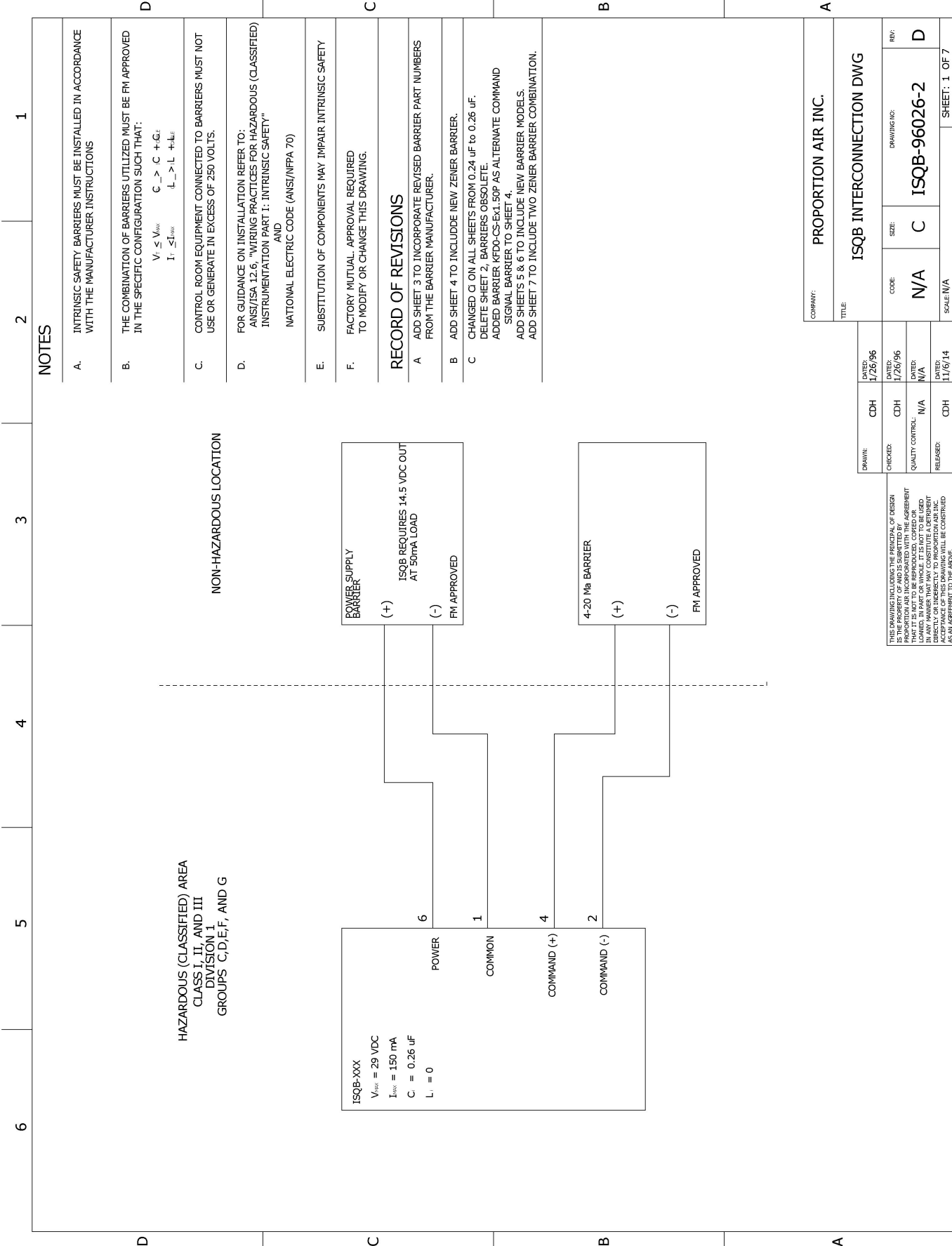

Figure 2

FIELD WIRING DRAWING ISQB-96026-2 (General Barrier)



NOTES

- A. INTRINSIC SAFETY BARRIERS MUST BE INSTALLED IN ACCORDANCE WITH THE MANUFACTURER INSTRUCTIONS
- B. THE COMBINATION OF BARRIERS UTILIZED MUST BE FM APPROVED IN THE SPECIFIC CONFIGURATION SUCH THAT:
 $V_i \leq V_{Max}$ $C > C + G_e$
 $I_i \leq I_{Max}$ $L_i > L + L_e$
- C. CONTROL ROOM EQUIPMENT CONNECTED TO BARRIERS MUST NOT USE OR GENERATE IN EXCESS OF 250 VOLTS.
- D. FOR GUIDANCE ON INSTALLATION REFER TO:
 ANSI/ISA 12.6, "WIRING PRACTICES FOR HAZARDOUS (CLASSIFIED) INSTRUMENTATION PART 1: INTRINSIC SAFETY"
 AND
 NATIONAL ELECTRIC CODE (ANSI/NFPA 70)
 E. SUBSTITUTION OF COMPONENTS MAY IMPAIR INTRINSIC SAFETY
 F. FACTORY MUTUAL APPROVAL REQUIRED TO MODIFY OR CHANGE THIS DRAWING.

RECORD OF REVISIONS

- A ADD SHEET 3 TO INCORPORATE REVISED BARRIER PART NUMBERS FROM THE BARRIER MANUFACTURER.
- B ADD SHEET 4 TO INCLUDE NEW ZENER BARRIER.
- C CHANGED CI ON ALL SHEETS FROM 0.24 uF to 0.26 uF. DELETE SHEET 2, BARRIERS OBSOLETE. ADDED BARRIER KFDD-CS-EX1.50P AS ALTERNATE COMMAND SIGNAL BARRIER TO SHEET 4. ADD SHEETS 5 & 6 TO INCLUDE NEW BARRIER MODELS. ADD SHEET 7 TO INCLUDE TWO ZENER BARRIER COMBINATION.

COMPANY:	PROPORTION AIR INC.		
TITLE:	ISQB INTERCONNECTION DWG		
DRAWN:	CDH	DATE:	11/26/96
CHECKED:	CDH	DATE:	11/26/96
QUALITY CONTROL:	N/A	DATE:	N/A
RELEASED:	CDH	DATE:	11/16/14
CODE:	N/A	SIZE:	C
DRAWING NO:	ISQB-96026-2		REV:
SCALE:	N/A	SHEET: 1 OF 7	

THIS DRAWING INCLUDING THE PRINCIPAL OF DESIGN IS THE PROPERTY OF PROPORTION AIR. ANY REPRODUCTION OR TRANSMISSION OF THIS DRAWING WITHOUT THE WRITTEN PERMISSION OF PROPORTION AIR IS STRICTLY PROHIBITED. IN ANY MANNER THAT MAY CONSTITUTE A VIOLATION OF FEDERAL, STATE OR LOCAL LAWS, OR DIRECTLY OR INDIRECTLY TO PROPORTION AIR, INC. OR ANY OF ITS AFFILIATES, SUCH REPRODUCTION OR TRANSMISSION WILL BE CONSIDERED AS AN AGREEMENT TO THE ABOVE.

FIELD WIRING DRAWING ISQB-96026-2 (PEPPERL-FUCHS KFD2)

1 2 3 4 5 6

NOTES

- A. INTRINSIC SAFETY BARRIERS MUST BE INSTALLED IN ACCORDANCE WITH THE MANUFACTURER INSTRUCTIONS
- B. CONTROL ROOM EQUIPMENT CONNECTED TO BARRIERS MUST NOT USE OR GENERATE IN EXCESS OF 250 VOLTS
- C. FOR GUIDANCE ON INSTALLATION REFER TO:
ANSI/ISA I2.6, "WIRING PRACTICES FOR HAZARDOUS (CLASSIFIED) LOCATIONS INSTRUMENTATION PART 1; INTRINSIC SAFETY"
AND
NATIONAL ELECTRIC CODE (ANSI/NFPA 70)
- D. SUBSTITUTION OF COMPONENTS MAY IMPAIR INTRINSIC SAFETY.
- E. FACTORY MUTUAL APPROVAL REQUIRED TO MODIFY OR CHANGE THIS DRAWING.

NON-HAZARDOUS LOCATION

HAZARDOUS (CLASSIFIED) AREA
CLASS I, II, AND III
DIVISION 1
GROUPS C,D,E,F, AND G

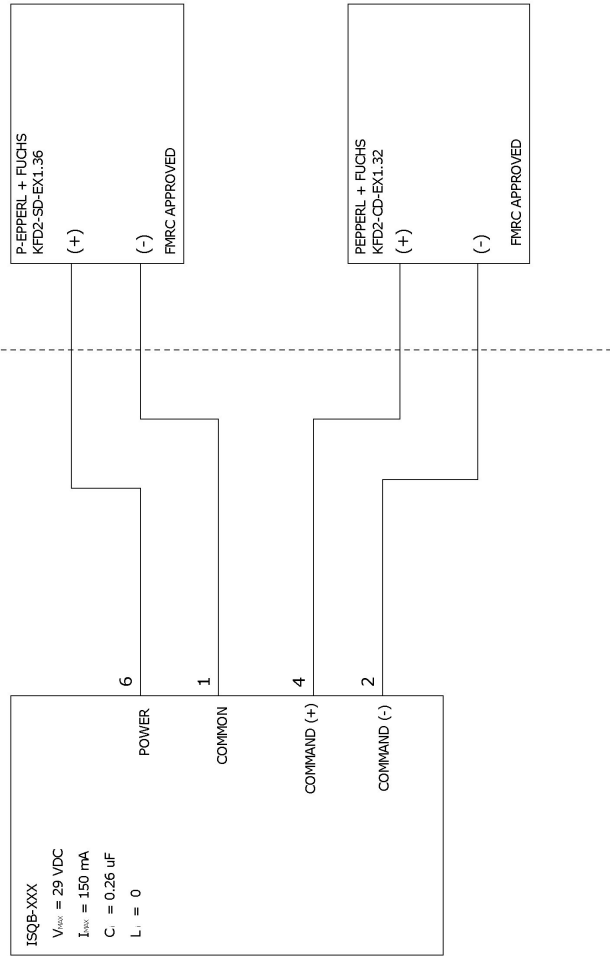

COMPANY:	PROPORTION AIR INC.		
TITLE:	ISQB INTERCONNECTION DWG		
DRAWN:	CDH	DATE:	11/26/96
CHECKED:	CDH	DATE:	11/26/96
QUALITY CONTROL:	N/A	DATE:	N/A
RELEASED:	CDH	DATE:	11/16/14
SCALE:	N/A		
REV:	D	DRAWING NO:	ISQB-96026-2
		SIZE:	C
		CODE:	N/A

THIS DRAWING INCLUDING THE PRINCIPAL OF DESIGN AND THE CONSTRUCTION OF THE BARRIERS IN THE PROPORTION AIR INCORPORATED WITH THE AGREEMENT THAT IT IS NOT TO BE REPRODUCED, COPIED OR OTHERWISE TRANSMITTED IN ANY MANNER WITHOUT THE DIRECT OR INDIRECT WRITTEN CONSENT OF PROPORTION AIR INC. AS AN AGREEMENT TO THE ABOVE.

SHEET: 3 OF 7

FIELD WIRING DRAWING ISQB-96026-2 (PEPPERL-FUCHS Z728/KFD2)

6 5 4 3 2 1

NOTES

- A. INTRINSIC SAFETY BARRIERS MUST BE INSTALLED IN ACCORDANCE WITH THE MANUFACTURER INSTRUCTIONS WITH THE FOLLOWING EXCEPTIONS:
 GROUP C, E 3.49 mH D, F, G 6.43 mH
- B. CONTROL ROOM EQUIPMENT CONNECTED TO BARRIERS MUST NOT USE OR GENERATE IN EXCESS OF 250 VOLTS
- C. FOR GUIDANCE ON INSTALLATION REFER TO:
 ANSI/ISA 12.6, "WIRING PRACTICES FOR HAZARDOUS (CLASSIFIED) LOCATIONS INSTRUMENTATION PART 1; INTRINSIC SAFETY" AND NATIONAL ELECTRIC CODE (ANSI/NFPA 70)
- D. SUBSTITUTION OF COMPONENTS MAY IMPAIR INTRINSIC SAFETY.
- E. FACTORY MUTUA APPROVAL REQUIRED TO MODIFY OR CHANGE THIS DRAWING.

HAZARDOUS (CLASSIFIED) AREA
 CLASS I, II, AND III
 DIVISION 1
 GROUPS C, D, E, F, AND G

NON-HAZARDOUS LOCATION

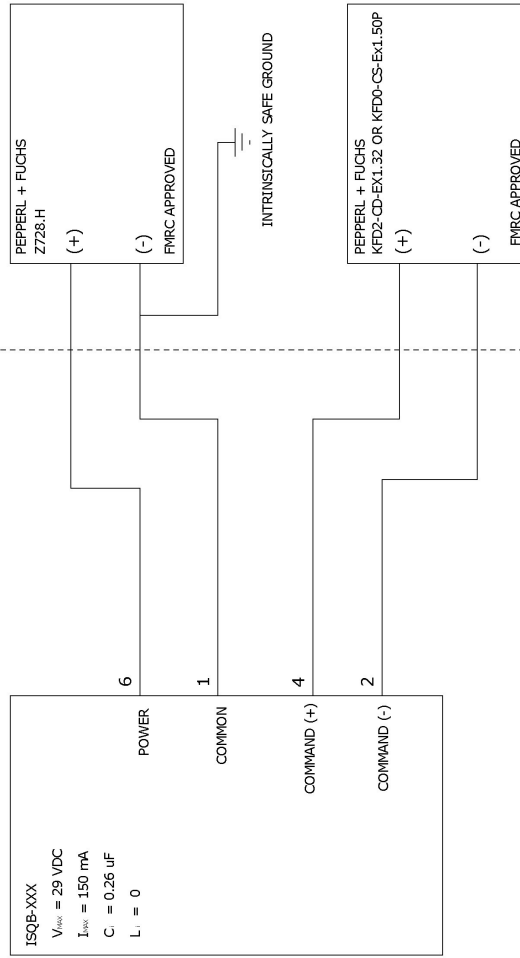

COMPANY:	PROPORTION AIR INC.			
TITLE:	ISQB INTERCONNECTION DWG			
DRAWN:	CDH	DATE:	11/26/96	REV:
CHECKED:	CDH	DATE:	11/29/96	D
QUALITY CONTROL:	N/A	DATE:	N/A	
RELEASED:	CDH	DATE:	11/16/14	
CODE:	N/A	SIZE:	C	DRAWING NO:
SCALE:	N/A			ISQB-96026-2
				SHEET: 4 OF 7

THIS DRAWING INCLUDING THE PRINCIPAL OF DESIGN IS THE PROPERTY OF PROPORTION AIR INC. AND IS NOT TO BE REPRODUCED, COPIED OR TRANSMITTED IN ANY MANNER THAT MAY CONSTITUTE A VIOLATION OF FEDERAL, STATE OR LOCAL LAWS OR REGULATIONS. ANY REUSE OF THIS DRAWING WITHOUT THE WRITTEN PERMISSION OF PROPORTION AIR INC. WILL BE CONSIDERED AS AN AGREEMENT TO THE ABOVE.

FIELD WIRING DRAWING ISQB-96026-2 (PHEONIX CONTACT MACX)

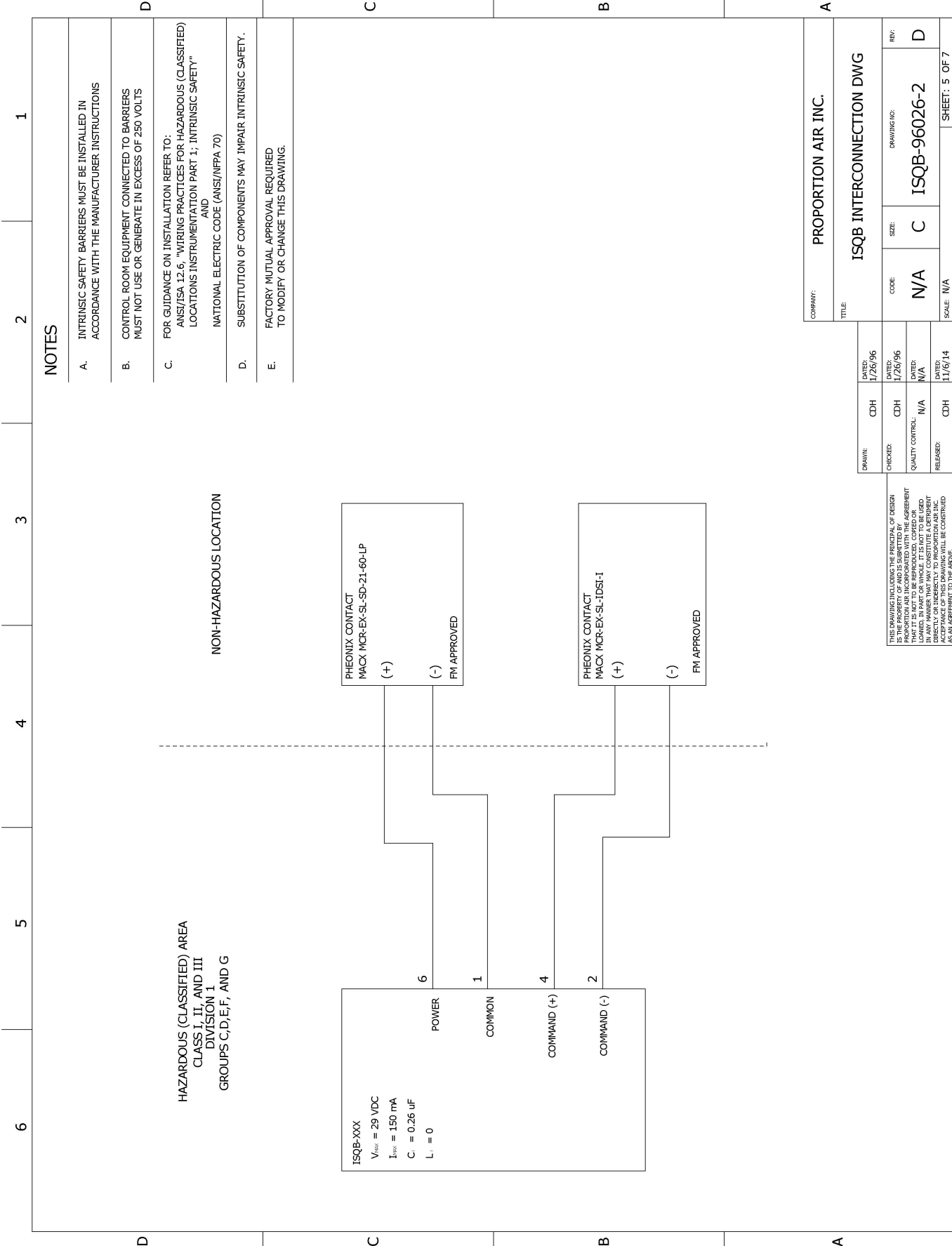

NOTES

- A. INTRINSIC SAFETY BARRIERS MUST BE INSTALLED IN ACCORDANCE WITH THE MANUFACTURER INSTRUCTIONS
- B. CONTROL ROOM EQUIPMENT CONNECTED TO BARRIERS MUST NOT USE OR GENERATE IN EXCESS OF 250 VOLTS
- C. FOR GUIDANCE ON INSTALLATION REFER TO:
ANSI/ISA I2.6, "WIRING PRACTICES FOR HAZARDOUS (CLASSIFIED) LOCATIONS INSTRUMENTATION PART 1; INTRINSIC SAFETY"
AND
NATIONAL ELECTRIC CODE (ANSI/NFPA 70)
- D. SUBSTITUTION OF COMPONENTS MAY IMPAIR INTRINSIC SAFETY.
- E. FACTORY MUTUAL APPROVAL REQUIRED TO MODIFY OR CHANGE THIS DRAWING.

COMPANY:		PROPORTION AIR INC.			
TITLE:		ISQB INTERCONNECTION DWG			
DRAWN:	DATE:	CHECKED:	DATE:	CODE:	SIZE:
CDH	11/26/96	CDH	11/26/96	N/A	C
QUALITY CONTROL:	DATE:	RELEASED:	DATE:	SCALE:	REV:
N/A	N/A	CDH	11/26/14	N/A	D
					DRAWING NO: ISQB-96026-2
					SHEET: 5 OF 7

THIS DRAWING INCLUDING THE PRINCIPAL OF DESIGN IS THE PROPERTY OF PROPORTION AIR. IT IS TO BE REPRODUCED, COPIED OR TRANSMITTED IN ANY MANNER THAT MAY CONSTITUTE A VIOLATION OF THE PATENT RIGHTS OF PROPORTION AIR INC. WITHOUT THE WRITTEN PERMISSION OF PROPORTION AIR INC. ANY SUCH VIOLATION WILL BE CONSIDERED AS AN AGREEMENT TO THE ABOVE.

FIELD WIRING DRAWING ISQB-96026-2 (PEPPERL-FUCHS KFD0)

6 5 4 3 2 1

NOTES

- A. INTRINSIC SAFETY BARRIERS MUST BE INSTALLED IN ACCORDANCE WITH THE MANUFACTURER INSTRUCTIONS
- B. CONTROL ROOM EQUIPMENT CONNECTED TO BARRIERS MUST NOT USE OR GENERATE IN EXCESS OF 250 VOLTS
- C. FOR GUIDANCE ON INSTALLATION REFER TO:
ANSI/ISA 12.6 "WIRING PRACTICES FOR HAZARDOUS (CLASSIFIED) LOCATIONS INSTRUMENTATION PART 1; INTRINSIC SAFETY"
AND
NATIONAL ELECTRIC CODE (ANSI/NFPA 70)
- D. SUBSTITUTION OF COMPONENTS MAY IMPAIR INTRINSIC SAFETY.
- E. FACTORY MUTUAL APPROVAL REQUIRED TO MODIFY OR CHANGE THIS DRAWING.

HAZARDOUS (CLASSIFIED) AREA
CLASS I, II, AND III
DIVISION 1
GROUPS C,D,E,F, AND G

NON-HAZARDOUS LOCATION

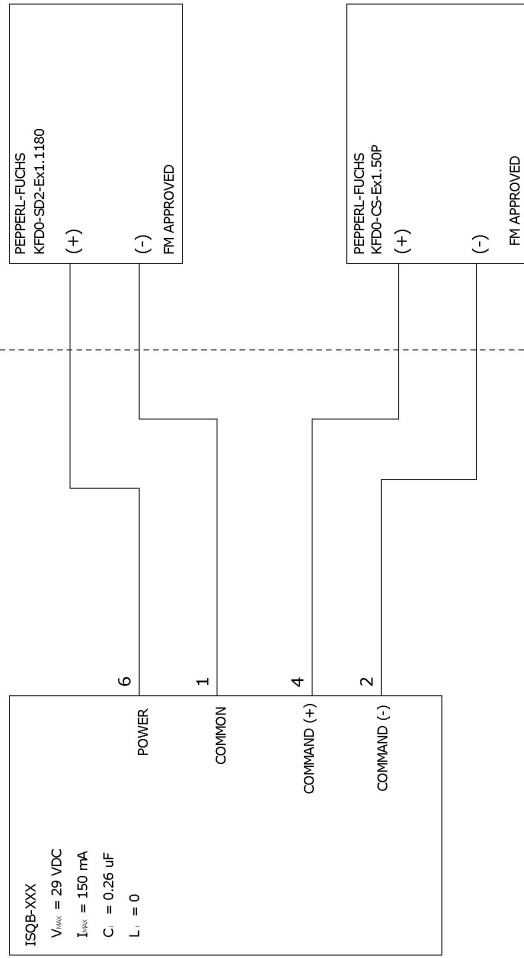

COMPANY:	PROPORTION AIR INC.		
TITLE:	ISQB INTERCONNECTION DWG		
DRAWING:	CDH	DATED:	1/26/96
CHECKED:	CDH	DATED:	1/26/96
QUALITY CONTROL:	N/A	DATED:	N/A
RELEASED:	CDH	DATED:	11/01/14
CODE:	N/A	SIZE:	C
DRAWING NO.:	ISQB-96026-2		
REV.:	D		
SCALE:	N/A		
			SHEET: 6 OF 7

THIS DRAWING IS THE PROPERTY OF PROPORTION AIR. IT IS TO BE USED ONLY FOR THE PROJECT AND SITE SPECIFICALLY IDENTIFIED IN THE TITLE. IT IS TO BE KEPT IN THE PROJECT FILES AND NOT REPRODUCED OR COPIED IN ANY MANNER THAT MAY CONSTITUTE A RETIREMENT OF THE PROJECT OR A VIOLATION OF THE ACCEPTANCE OF THIS DRAWING WILL BE CONSIDERED AS AN AGREEMENT TO THE ABOVE.

FIELD WIRING DRAWING ISQB-96026-2 (PEPPERL-FUCHS Z728)

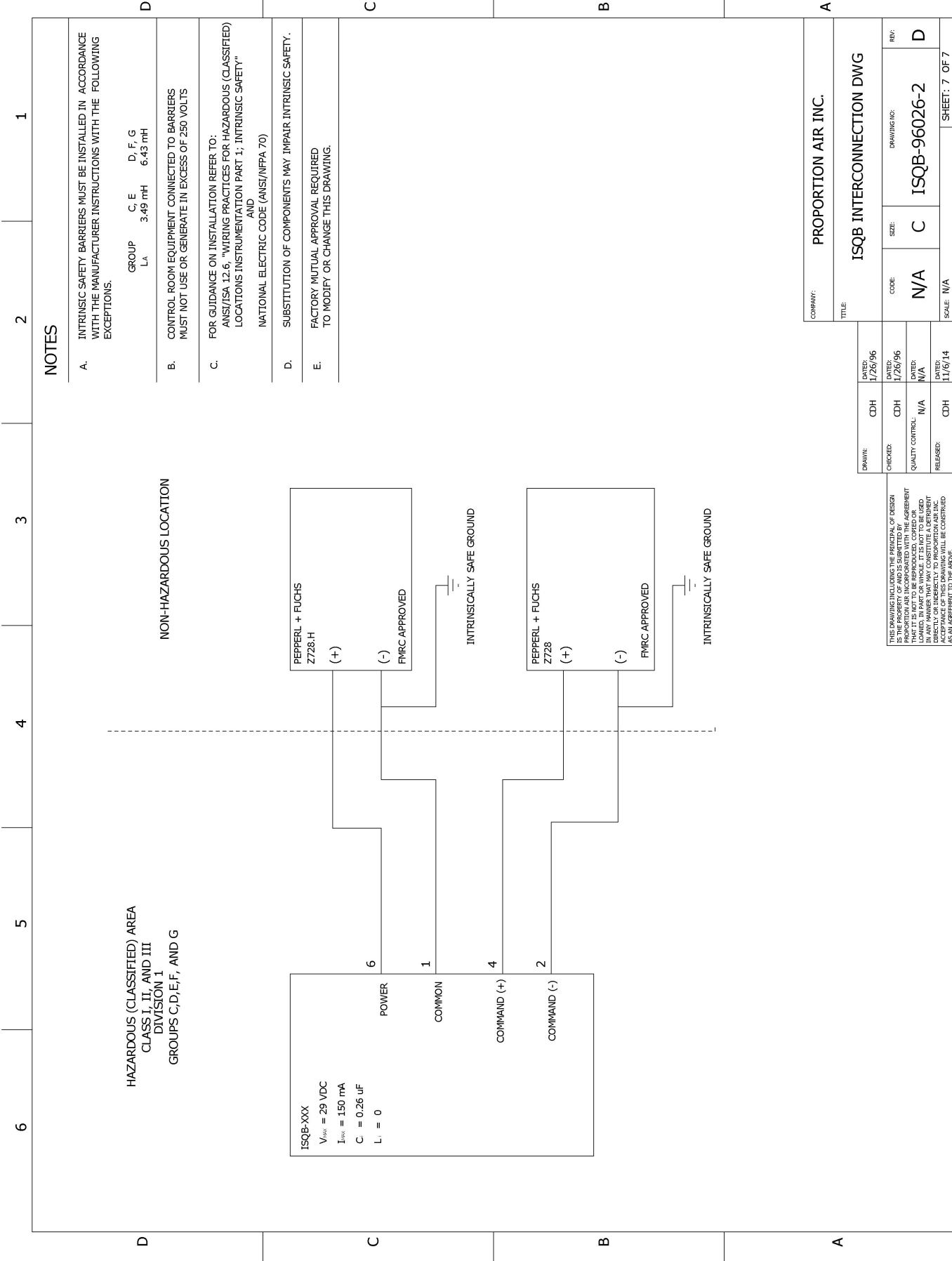

NOTES

- A. INTRINSIC SAFETY BARRIERS MUST BE INSTALLED IN ACCORDANCE WITH THE MANUFACTURER INSTRUCTIONS WITH THE FOLLOWING EXCEPTIONS:

GROUP	C, E	D, F, G
L _A	3.49 mH	6.43 mH
- B. CONTROL ROOM EQUIPMENT CONNECTED TO BARRIERS MUST NOT USE OR GENERATE IN EXCESS OF 250 VOLTS
- C. FOR GUIDANCE ON INSTALLATION REFER TO:
 ANSI/ISA 12.6, "WIRING PRACTICES FOR HAZARDOUS (CLASSIFIED) LOCATIONS INSTRUMENTATION PART 1; INTRINSIC SAFETY" AND
 NATIONAL ELECTRIC CODE (ANSI/NFPA 70)
- D. SUBSTITUTION OF COMPONENTS MAY IMPAIR INTRINSIC SAFETY.
- E. FACTORY MUTUAL APPROVAL REQUIRED TO MODIFY OR CHANGE THIS DRAWING.

COMPANY: PROPORTION AIR INC.	
TITLE: ISQB INTERCONNECTION DWG	
DRAWN: CDH	DATE: 11/26/96
CHECKED: CDH	DATE: 11/26/96
QUALITY CONTROL: N/A	DATE: N/A
RELEASED: CDH	DATE: 11/16/14
CODE: N/A	SIZE: C
DRAWING NO: ISQB-96026-2	REV: D
SCALE: N/A	SHEET: 7 OF 7

THIS DRAWING INCLUDING THE PRINCIPAL OF DESIGN IS THE PROPERTY OF PROPORTION AIR. IT IS TO BE REPRODUCED, COPIED OR TRANSMITTED IN ANY MANNER THAT MAY CONSTITUTE A VIOLATION OF THE PATENT RIGHTS OF PROPORTION AIR. ANY DIRECT OR INDIRECT USE OF THIS DRAWING WITHOUT THE WRITTEN PERMISSION OF PROPORTION AIR WILL BE CONSIDERED AS AN AGREEMENT TO THE ABOVE.

Example Part Number : **ISQB1 T B N I X Z P 150 PS G BR**

YOUR PART NUMBER : **T I X**

Section ---> 1 2 3 4 5 6 7 8 9 10 11 12 Options

1 Series

- ISF1** Nonincindive **ISF1***
- ISQB1** Intrinsically Safe **ISQB1**

2 Sensor Type

- T** -14.7 to 150 psig

3 Manifold Material

- B** Brass (*Standard*)
- A** Aluminum

4 Thread Type

- N** NPT (*Standard*)
- P** BSPP

5 Input Signal Range

- I** 4 to 20 mADC

6 Monitor Signal Range

- X** No Monitor

7 Zero Offset

- N** 0% Pressure Starts Below Atmosphere
- P** 0% Pressure Starts Above Atmosphere
- Z** 0% Pressure Starts at Zero (*Typical*)

8 Zero Offset Pressure

Typical is 0 (blank) - If Greater than 30% of Full Scale Pressure (#9 below) Please Consult Factory.*

**If Z for Zero Offset (#7), please leave blank*

9 Full Scale Pressure Type

- N** 100% Pressure Ends Below Atmosphere
- P** 100% Pressure Ends Above Atmosphere
- Z** 100% Pressure Ends at Zero

10 Full Scale Pressure

Must be less than or equal to 150 psig

11 Pressure Unit

- PS** PSI Inches Hg **IH**
- MB** Millibars Inches H₂O **IW**
- BR** Bar mm H₂O **MW**
- KP** Kilopascal Kilograms/cm² **KG**
- MP** Megapascal Torr* **TR**
- MH** mm Hg **Requires A for Pressure Unit of Measure*

12 Pressure Unit of Measure

- A** Absolute Pressure
- G** Gage Pressure

13 Options

- R1** Rotate Connector 180 Degrees
- BR** Install Foot Bracket

MOUNTING BRACKET

Type	Bracket P#
Wrap-Around	QBT-01

Please Note: The user has the additional responsibility of supplying and or ensuring that the connector/cable that is used with any Proportion-Air ISQB or ISF1 series FM approved product, meets all local and national codes for intrinsically safe wiring.

RE-CALIBRATION PROCEDURE

All ISQB1 valves come calibrated from the factory by trained personnel using precision calibration equipment. The ISQB1 is a closed loop control valve using a precision electronic pressure sensor. Typical drift is less than 1% over the life of the product. If your ISQB1 appears to be out of calibration by more than 1%, it is not likely to be ISQB1. Check the system for plumbing leakage, wiring and electronic signal levels. Verify the accuracy of your measuring equipment before re-calibrating. If the ISQB1 valve needs re-calibration, use the procedure described below:

Re-calibration:

1. Wire the ISQB1 according to the section titled "Electrical Connections."
2. Connect a precision pressure gage or pressure transducer to the OUTLET PORT of the ISQB1.

NOTE: There must be a closed volume of at least 1 in³ between the OUTLET PORT and the measuring device for the ISQB1 to be stable.

3. Provide supply pressure to the INLET PORT of the ISQB1. (See figure 1). Make sure supply pressure does not exceed the rating for the valve. (see table 1)

4. Remove the zero and span plug on top of the ISQB1 to access the ZERO and SPAN adjustment potentiometers (figure 1).

NOTE: Only use this step if your device is totally out of calibration. If it is slightly out of calibration, omit this step and move on to paragraph 5. Using a small screwdriver, turn both potentiometers 15 turns clockwise. Then turn them 7 turns counter clockwise. This will put the ISQB1 roughly at mid scale.

5. Set the electrical command input to 20mADC. Adjust the SPAN potentiometer until MAXIMUM desired pressure is reached (clockwise to increase pressure).
6. Set the electrical command input to 10 percent of full value (5.6mA).
7. Adjust the ZERO potentiometer until 10 percent of maximum desired pressure is reached. (clockwise increases pressure).
8. The ZERO and SPAN potentiometers interact slightly. Repeat steps 5-10 until no error exists.
9. Verify unit shuts off by going to 4mADC command. Check linearity by going to at least six pressures throughout the full range.

ISQB1 & BRACKET DIMENSIONS

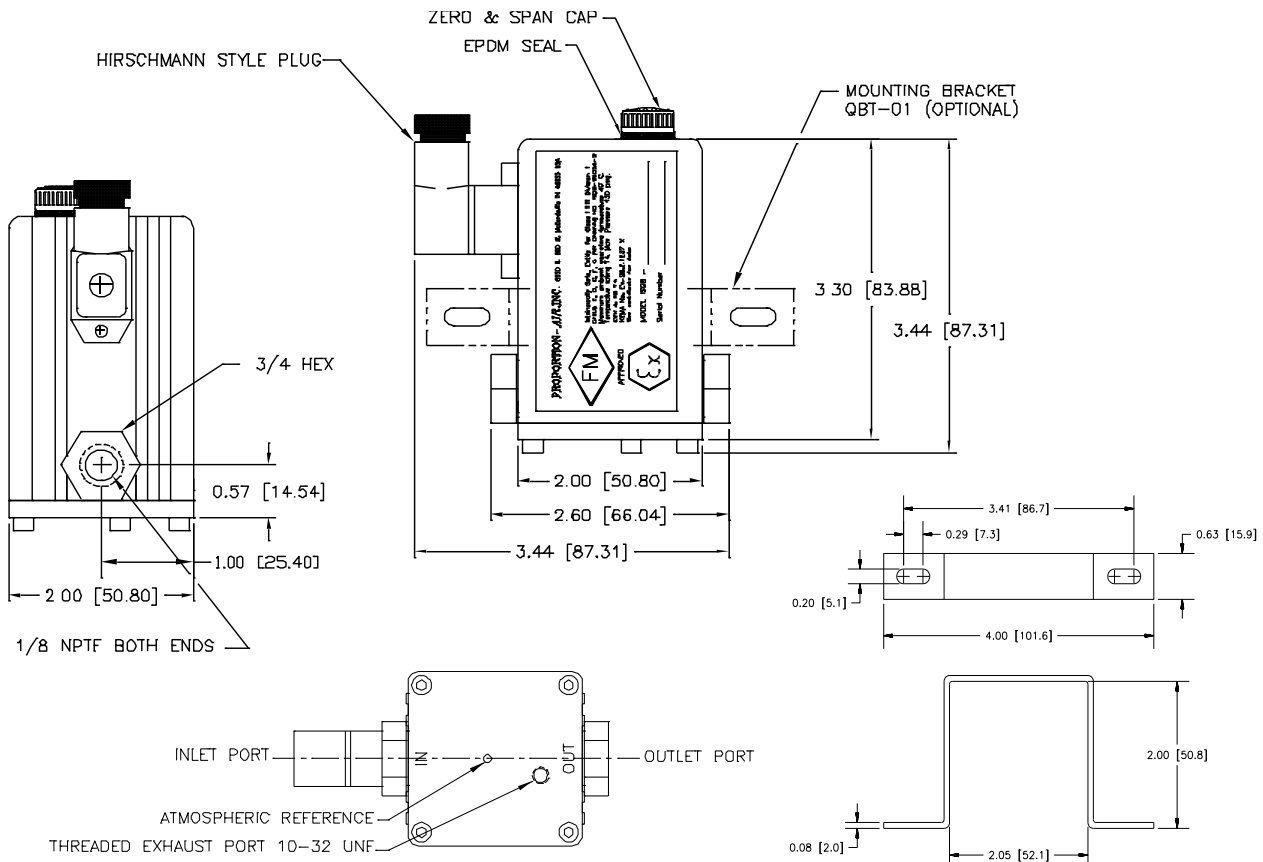



Please read all of the following Safety Precautions before installing or operating any Proportion-Air, Inc. equipment or accessories. To confirm safety, be sure to observe 'ISO 4414: Pneumatic Fluid Power - General rules relating to systems' and other safety practices.



Warning

Improper operation could result in serious injury to persons or loss of life!

1. PRODUCT COMPATIBILITY

Proportion-Air, Inc. products and accessories are for use in industrial pneumatic applications with compressed air media. The compatibility of the equipment is the responsibility of the end user. Product performance and safety are the responsibility of the person who determined the compatibility of the system. Also, this person is responsible for continuously reviewing the suitability of the products specified for the system, referencing the latest catalog, installation manual, Safety Precautions and all materials related to the product.

2. EMERGENCY SHUTOFF

Proportion, Inc. products cannot be used as an emergency shutoff. A redundant safety system should be installed in the system to prevent serious injury or loss of life.

3. EXPLOSIVE ATMOSPHERES

Products and equipment should not be used where harmful, corrosive or explosive materials or gases are present. Unless certified, Proportion-Air, Inc. products cannot be used with flammable gases or in hazardous environments.

4. AIR QUALITY

Clean, dry air is not required for Proportion-Air, Inc. products. However, a 40 micron particulate filter is recommended to prevent solid contamination from entering the product.

5. TEMPERATURE

Products should be used with a media and ambient environment inside of the specified temperature range of 32°F to 158°F. Consult factory for expanded temperature ranges.

6. OPERATION

Only trained and certified personnel should operate electronic and pneumatic machinery and equipment. Electronics and pneumatics are very dangerous when handled incorrectly. All industry standard safety guidelines should be observed.

7. SERVICE AND MAINTENANCE

Service and maintenance of machinery and equipment should only be handled by trained and experienced operators. Inspection should only be performed after safety has been confirmed. Ensure all supply pressure has been exhausted and residual energy (compressed gas, springs, gravity, etc.) has been released in the entire system prior to removing equipment for service or maintenance.



Caution

Improper operation could result in serious injury to persons or damages to equipment!

1. PNEUMATIC CONNECTION

All pipes, pneumatic hose and tubing should be free of all contamination, debris and chips prior to installation. Flush pipes with compressed air to remove any loose particles.

2. THREAD SEALANT

To prevent product contamination, thread tape is not recommended. Instead, a non-migrating thread sealant is recommended for installation. Apply sealant a couple threads from the end of the pipe thread to prevent contamination.

3. ELECTRICAL CONNECTION

To prevent electronic damage, all electrical specifications should be reviewed and all electrical connections should be verified prior to operation.

Exemption from Liability

1. **Proportion-Air, Inc.** is exempted from any damages resulting from any operations not contained within the catalogs and/or instruction manuals and operations outside the range of its product specifications.

2. **Proportion-Air, Inc.** is exempted from any damage or loss whatsoever caused by malfunctions of its products when combined with other devices or software.

3. **Proportion-Air, Inc.** and its employees shall be exempted from any damage or loss resulting from earthquakes, fire, third person actions, accidents, intentional or unintentional operator error, product misapplication or irregular operating conditions.

4. **Proportion-Air, Inc.** and its employees shall be exempted from any damage or loss, either direct or indirect, including consequential damage or loss, claims, proceedings, demands, costs, expenses, judgments, awards, loss of profits or loss of chance and any other liability whatsoever including legal expenses and costs, which may be suffered or incurred, whether in tort (including negligence), contract, breach of statutory duty, equity or otherwise.

Warranty

Proportion-Air, Inc. products are warranted to the original purchaser only against defects in material or workmanship for one (1) year from the date of manufacture. The extent of Proportion-Air's liability under this warranty is limited to repair or replacement of the defective unit at Proportion-Air's option. Proportion-Air shall have no liability under this warranty where improper installation or filtration occurred.