

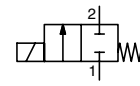

# SOLENOID VALVES

direct operated  
for high pressure fluids  
1/4

NC



NO

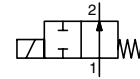

2/2  
Series  
262

## FEATURES

- Valves do not require a minimum operating pressure and have a high operating pressure as indicated
- Valve operation is not affected by mounting position
- The solenoid valves satisfy all relevant EC directives

## GENERAL

Differential pressure See «SPECIFICATIONS» [1 bar =100 kPa]  
Maximum viscosity 65 cSt (mm<sup>2</sup>/s)  
Response time 5 - 25 ms

fluids (*)	temperature range (TS)	seal materials (*)
air, inert gas, water, oil	-20°C to +90°C -20°C to +40°C	NBR (nitrile) UR (cast urethane)

## MATERIALS IN CONTACT WITH FLUID

(\*) Ensure that the compatibility of the fluids in contact with the materials is verified

Body Brass  
Core tube Stainless steel  
Core and plugnut Stainless steel  
Springs Stainless steel  
Seat Brass  
Seals NBR  
Disc NBR or UR  
Disc holder (NO function) PA  
Shading coil Copper

## ELECTRICAL CHARACTERISTICS

Coil insulation class F  
Connector Spade plug (cable Ø 6-10 mm)  
Connector specification ISO 4400 / EN 175301-803, form A  
Electrical safety IEC 335  
Electrical enclosure protection Moulded IP65 (EN 60529)  
Standard voltages DC (-) : 24V - 48V  
(Other voltages and 60 Hz on request) AC (~) : 24V - 48V - 115V - 230V / 50 Hz

prefix option	power ratings				operator ambient temperature range (TS) (C°)	replacement coil		type <sup>(1)</sup>
	inrush ~		holding ~			~	=	
	(VA)	(VA)	(W)	(W)		230 V/50 Hz	24 V DC	
SC	34	15,6	6	7 / 9,7	-20 to +75	400325-117	400325-142	01
	30	22,5	9	9,5/15,3	-20 to +50	400325-217	400325-242	01
	55	23	10,5	9/11,2	-20 to +75	400425-117	400425-142	02
	78	35	16,7	-	-20 to +50	400425-217	-	02
	-	-	-	14/19,7	-20 to +25	-	400425-342	02

(1) Refer to the dimensional drawings on the following page.

## SPECIFICATIONS

pipe size	orifice size	flow coefficient Kv		operating pressure differential (bar)						power coil (W)		catalogue number	options						
				min.	max. (PS)			min.	max.				min.	max.	maintained man. operator	FPM	EPDM	CR	PTFE
					air (*)	water (*)	oil (*)												
G	(mm)	(m <sup>3</sup> /h)	(l/min)									~/=							
<b>NC - Normally closed, NBR seals and disc</b>																			
1/4	1,2	0,05	0,8	0	50	35	50	35	35	35	6	9,7	SCG262C019	-	V	E	J	T	
					25	10	25	8	11	8	6	9,7	SCG262C020	-	V	E	J	T	
	3,2	0,3	5	0	35	15	35	10	20	10	9	15,3	SCG262C021	-	V	E	J	T	
					9	4	11	4	6	4	6	9,7	SCG262C022	MO	V	E	J	T	
					15	7	16	6	11	6	9	15,3	SCG262C023	MO	V	E	J	T	
					20	5	20	4	13	4	10,5	11,2	SCG262D232	MO	V	E	J	T	
	4	0,43	7,2	0	12	2,5	13	2,5	10	3	10,5	11,2	SCG262C202	MO	V	E	J	T	
					6,5	1,7	6,5	1,7	6,5	1,7	10,5	11,2	SCG262C208	MO	V	E	J	T	
	5,6	0,73	12,2	0	2,5	1,2	3,0	1,3	2,5	1,3	6	9,7	SCG262C013	MO	V	E	J	T	
					1,8	1	2,5	1	1,9	1	6	9,7	SCG262C090	MO	V	E	J	T	
					4	1,2	5	1	4	1,2	10,5	11,2	SCG262C210	MO	V	E	J	T	
	7,1	0,75	12,5	0	6	1,7	6,5	1,3	6	1,3	16,7	19,7	SCG262B212	-	V	E	J	T	
<b>NC - Normally closed, NBR seals and UR disc</b>																			
1/4	1,2	0,05	0,8	0	100	32	100	32	75	30	10,5	11,2	SCG262D200	MO	-	-	-	T	
<b>NO - Normally open, NBR seals and disc</b>																			
1/4	3,2	0,3	5	0	9	5,5	7	4	6,5	4	10,5	11,2	SCG262A262	-	V	E	J	T	
					5,5	3	5	2	4	2	10,5	11,2	SCG262A263	-	V	E	J	T	
	5,6	0,73	12,2	0	3	1,7	2,5	1,3	2,5	1,3	10,5	11,2	SCG262A264	-	V	E	J	T	
					2	1	1,7	1	1,3	1	10,5	11,2	SCG262A265	-	V	E	J	T	
<b>NO - Normally open, NBR seals and UR disc</b>																			
1/4	1,2	0,05	0,8	0	50	35	50	45	50	50	10,5	11,2	SCG262A260	-	-	-	-	T	
					20	13	20	10	10	9	10,5	11,2	SCG262A261	-	-	-	-	T	

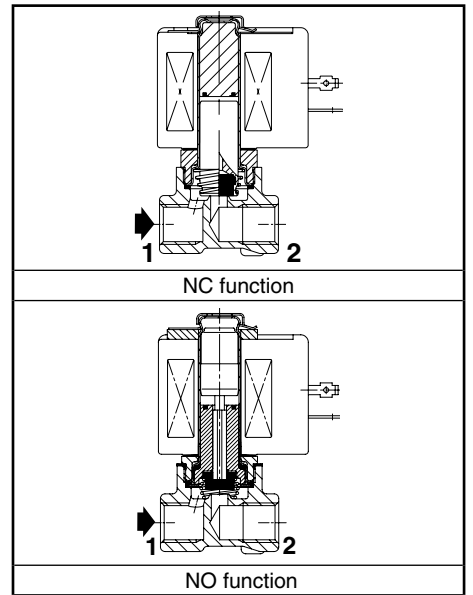

00031GB-2011/R01 Availability, design and specifications are subject to change without notice. All rights reserved.

### OPTIONS

- Valves can also be supplied with FPM (fluoroelastomer), EPDM (ethylene-propylene), CR (chloroprene) and PTFE seals and discs. Use the appropriate optional suffix letter for identification
- Waterproof enclosure with embedded screw terminal coil according to protection class IP67, CEE-10
- Explosionproof enclosures for use in zones 1/21-2/22, categories 2-3 to ATEX Directive 94/9/EC (see "Explosionproof solenoids" section)
- Electrical enclosures according to "NEMA" standards are available
- Compliance with "UL", "CSA" and other local approvals available on request
- Mounting brackets, suffix MB
- Other pipe connections are available on request
- Plug with visual indication and peak voltage suppression or with cable length of 2 m (see Solenoids, Coils & Accessories section)

### INSTALLATION

- The solenoid valves can be mounted in any position without affecting operation
- Solenoid valves have 2 mounting holes in body
- Pipe connection identifier is G = G (ISO 228/1)
- Installation/maintenance instructions are included with each valve

### SPARE PARTS KIT & ACCESSORIES

catalogue number	spare parts kit no.		mounting bracket no.
	~	=	
SCG262C013/090	<b>C302022</b>	<b>C302068</b>	<b>254573-001</b>
SCG262C019/020/021/022/023	<b>C302018</b>	<b>C302068</b>	-
SCG262A260/261	<b>C302045</b>	<b>C302076</b>	<b>206525-001</b>
SCG262A262/263/264/265	<b>C302051</b>	<b>C302080</b>	<b>254573-001</b>
SCG262D200	<b>C304350</b>	<b>C304350</b>	<b>206525-001</b>
SCG262C202/208/210	<b>C304354</b>	<b>C304354</b>	<b>254573-001</b>
SCG262B212/D232	<b>C304354</b>	<b>C304354</b>	<b>206525-001</b>

<sup>(1)</sup> Standard prefixes/suffixes are also applicable to kits.  
- Not available

### ORDERING EXAMPLES:

SC	G	262	C	010	230V / 50 Hz
SC	G	262	C	020	MO 115V / 50 Hz
SC	G	262	C	022	V 24V / DC
SC	G	262	D	200	T 230V / 50 Hz

prefix      pipe thread      basic number      voltage      suffix

### ORDERING EXAMPLES KITS:

C302045 <sup>(1)</sup>	
C302051	V
C302051	E

basic number      suffix

### DIMENSIONS (mm), WEIGHT (kg)



#### TYPE 01-02

Prefix "SC" Solenoid  
Epoxy moulded  
IEC 335 / ISO 4400  
IP65

Type 01: SCG262C019/020/021/022/023/013/090

Type 02: SCG262D232/C202/C208/C210/B212/D200

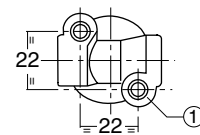
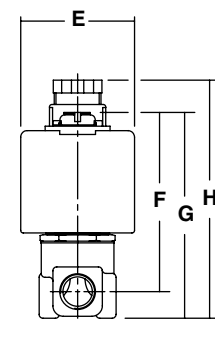
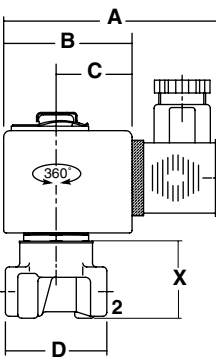
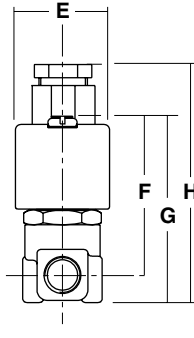
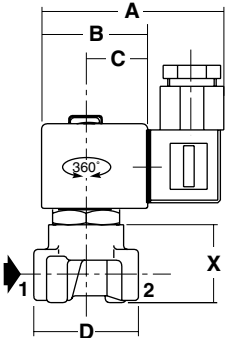

bottom view

① 2 mounting holes Ø M4, depth 6 mm

type	prefix option	A	B	C	D	E	F	G	H	X	weight <sup>(2)</sup>	
											NC	NO
01	SC	75	45	27	40	39	65	75	92	30	0,4	-
02	SC	80	50	30	40	45	69	80	96	30	0,45	0,5

<sup>(2)</sup> including coil and connector.

All leaflets are available on: [www.asconumatics.eu](http://www.asconumatics.eu)